

PURY-EM200, 250, 300YXM-A/TR (-BS)

Unit: mm

PURY-EM-Y(S)XM-A/TR

Connecting pipe specifications

Model	Refrigerant pipe*1		Diameter	
	High pressure	Low pressure	High pressure	Low pressure
EM200	φ15.88	φ19.05	Brazed	φ28.58
EM250	φ19.05	φ22.2	Brazed	φ28.58
EM300	φ19.05	φ22.2	Brazed	φ28.58

*1 Connect the refrigerant pipe to the service valve according to the installation Manual.

NO.	Usage	Specifications
①	Front through hole	145 × 77 Knockout hole
②	Bottom through hole	150 × 90 Knockout hole
③	Front through hole	φ65 or φ40 Knockout hole
④	Front through hole	φ52 or φ27 Knockout hole
⑤	Bottom through hole	φ65 Knockout hole
⑥	Bottom through hole	φ52 Knockout hole
⑦	Front through hole	φ34 Knockout hole
⑧	Bottom through hole	φ34 Knockout hole

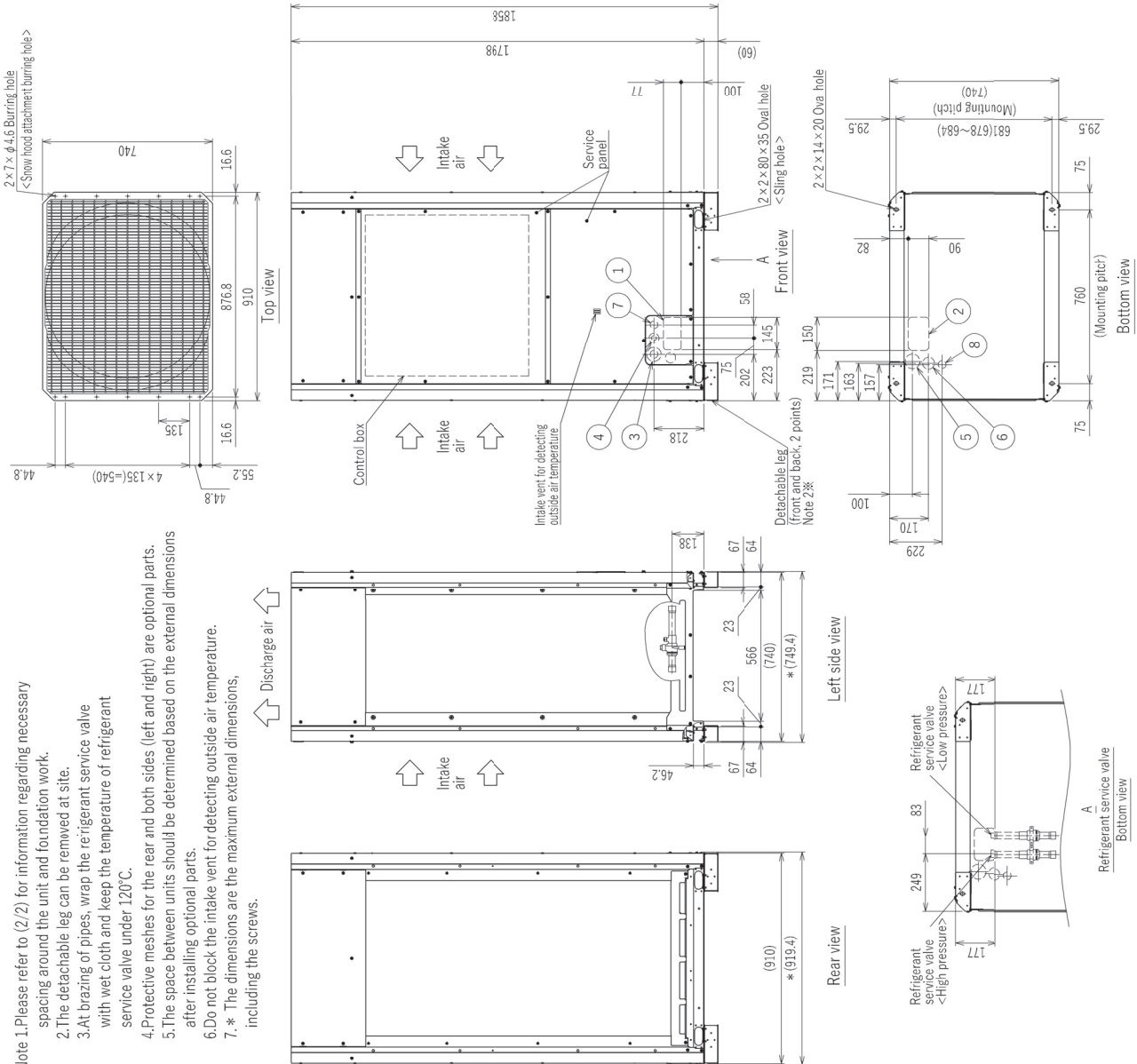

- Note 1. Please refer to (2/2) for information regarding necessary spacing around the unit and foundation work.
 2. The detachable leg can be removed at site.
 3. At brazing of pipes, wrap the refrigerant service valve with wet cloth and keep the temperature of refrigerant service valve under 120°C.
 4. Protective meshes for the rear and both sides (left and right) are optional parts.
 5. The space between units should be determined based on the external dimensions after installing optional parts.
 6. Do not block the intake vent for detecting outside air temperature.
 7. * The dimensions are the maximum external dimensions, including the screws.

PURY-EM200, 250, 300YXM-A/TR (-BS)

Unit: mm

1. Required space around the unit

● In case of single installation

- ① Secure enough space around the unit as shown in the figure below.
 - With a space of at least 300mm to the wall on the back of the unit

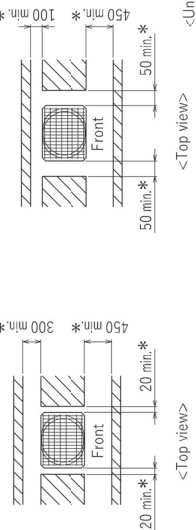

- ② When the height of the walls on the front, back or on the sides H exceeds the wall height limit as defined below add half of the height that exceeds the height limit $$H/2$$ to the figures that are marked with an asterisk (*).
When adjacent to a building wall, ensure that at least two directions are open, with a rear space of at least 300mm and a side space of at least 200mm from the wall.

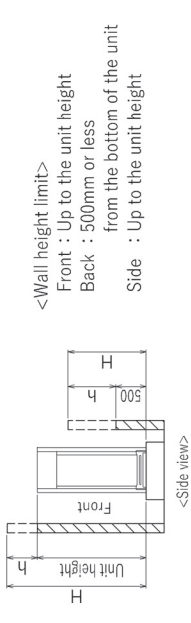

2. Foundation work

- ① Take into consideration the surface strength, water drainage route, piping route, and wiring route when preparing the installation site.
<Note that the drain water comes out of the unit during operation.>
- ② Build the foundation in such way that the corner of the installation leg is securely supported as shown in the right figure.(Fig.A,B)
When using a rubber isolating cushion, please ensure it is large enough to cover the entire width of each of the unit's legs.
- ③ The protrusion length of the anchor bolt must not exceed 30mm.(Fig.A,B)
- ④ Use four fixing plates as shown in the right figure.<field supply required>(Fig.A,B) when using M12 hole-in anchor bolts.<field supply required>.(Fig.C,D)
- ⑤ To prevent small animals and water and snow from entering the unit and damaging its parts, close the gap around the edges of through holes for pipes and wires with filler plates.<field supply required>.
- ⑥ When the pipes or cables are routed at the bottom of the unit, make sure that the through hole at the base of the unit does not get blocked with the installation base.
- ⑦ Refer to the Installation Manual when installing units on an installation base.

● In case of collective installation

- ① When multiple units are installed adjacent to each other, secure enough space to allow for air circulation and walkway between groups of units as shown in the figures below.
- ② At least two sides must be left open.
- ③ As with the single installation, add half of the height that exceeds the height limit $$H/2$$ to the figures that are marked with an asterisk(*).
When adjacent to a building wall, ensure that at least two directions are open, with a rear space of at least 300mm and a side space of at least 200mm from the wall.
When installing units side by side, ensure a space of at least 400mm between the units.
- ④ If there is a wall at both the front and the rear of the unit, install up to six units consecutively in the side direction and provide a space of 1000mm or more as inlet space / passage space for each six units.

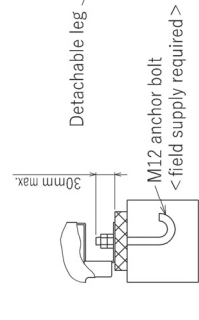
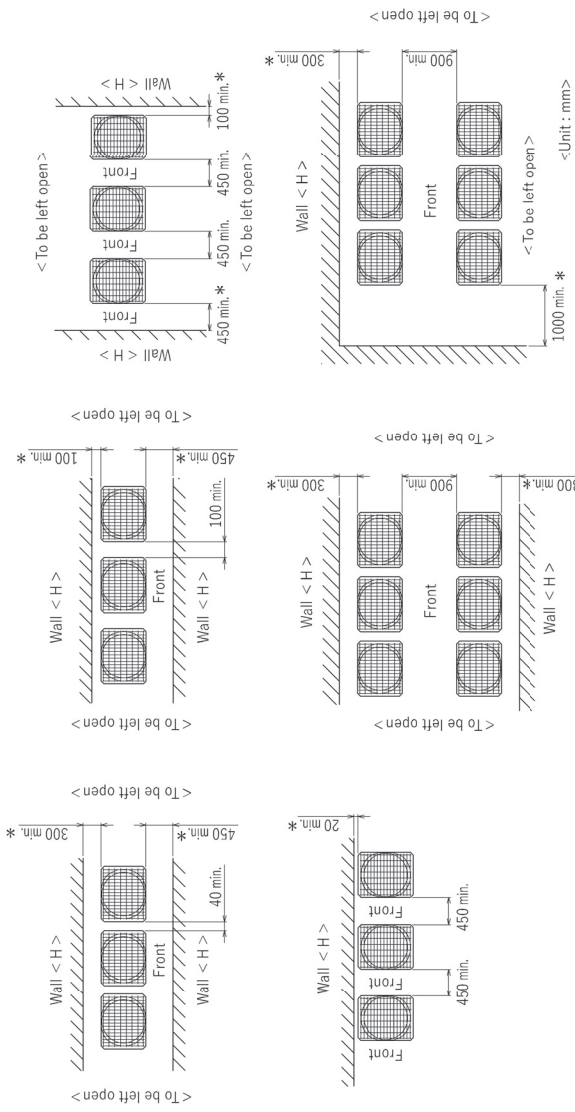

Fig. A(without detachable legs)

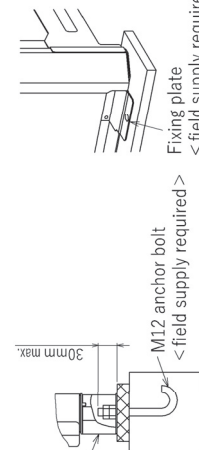

Fig. B(with detachable legs)

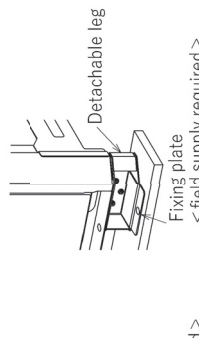

Fig. C(without detachable legs)

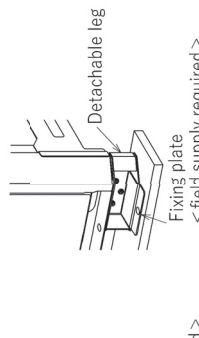

Fig. D(with detachable legs)

PURY-EM350, 400, 450, 500YXM-A/TR (-BS)

Unit: mm

1. Required space around the unit

● In case of single installation

- ① Secure enough space around the unit as shown in the figure below.
 - With a space of at least 300mm to the wall on the back of the unit

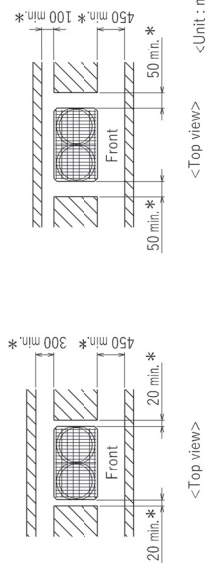

- ② When the height of the walls on the front, back or on the sides <H> exceeds the wall height limit as defined below add half of the height that exceeds the height limit $<h/2>$ to the figures that are marked with an asterisk (*).
When adjacent to a building wall, ensure that at least two directions are open, with a rear space of at least 300mm and a side space of at least 200mm from the wall.

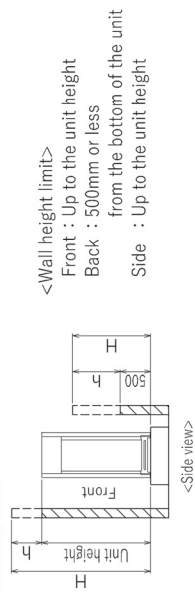

2. Foundation work

- ① Take into consideration the surface strength, water drainage route, piping route, and wiring route when preparing the installation site.
<Note that the drain water comes out of the unit during operation.>
- ② Build the foundation in such way that the corner of the installation leg is securely supported as shown in the right figure.(Fig.A,B)
When using a rubber isolating cushion, please ensure it is large enough to cover the entire width of each of the unit's legs.
- ③ The protrusion length of the anchor bolt must not exceed 30mm.(Fig.A,B)
- ④ Use four fixing plates as shown in the right figure <field supply required> when using M12 hole-in anchor bolts <field supply required>.(Fig.C,D)
- ⑤ To prevent small animals and water and snow from entering the unit and damaging its parts, close the gap around the edges of through holes for pipes and wires with filler plates <field supply required>.
- ⑥ When the pipes or cables are routed at the bottom of the unit, make sure that the through hole at the base of the unit does not get blocked with the installation base.
- ⑦ Refer to the Installation Manual when installing units on an installation base.

● In case of collective installation

- ① When multiple units are installed adjacent to each other, secure enough space to allow for air circulation and walkway between groups of units as shown in the figures below.
- ② At least two sides must be left open.
- ③ As with the single installation, add half of the height that exceeds the height limit $<h/2>$ to the figures that are marked with an asterisk(*).
When adjacent to a building wall, ensure that at least two directions are open, with a rear space of at least 300mm and a side space of at least 200mm from the wall.
When installing units side by side, ensure a space of at least 400mm between the units.
- ④ If there is a wall at both the front and the rear of the unit, install up to six units consecutively in the side direction and provide a space of 1000mm or more as inlet space / passage space for each six units.

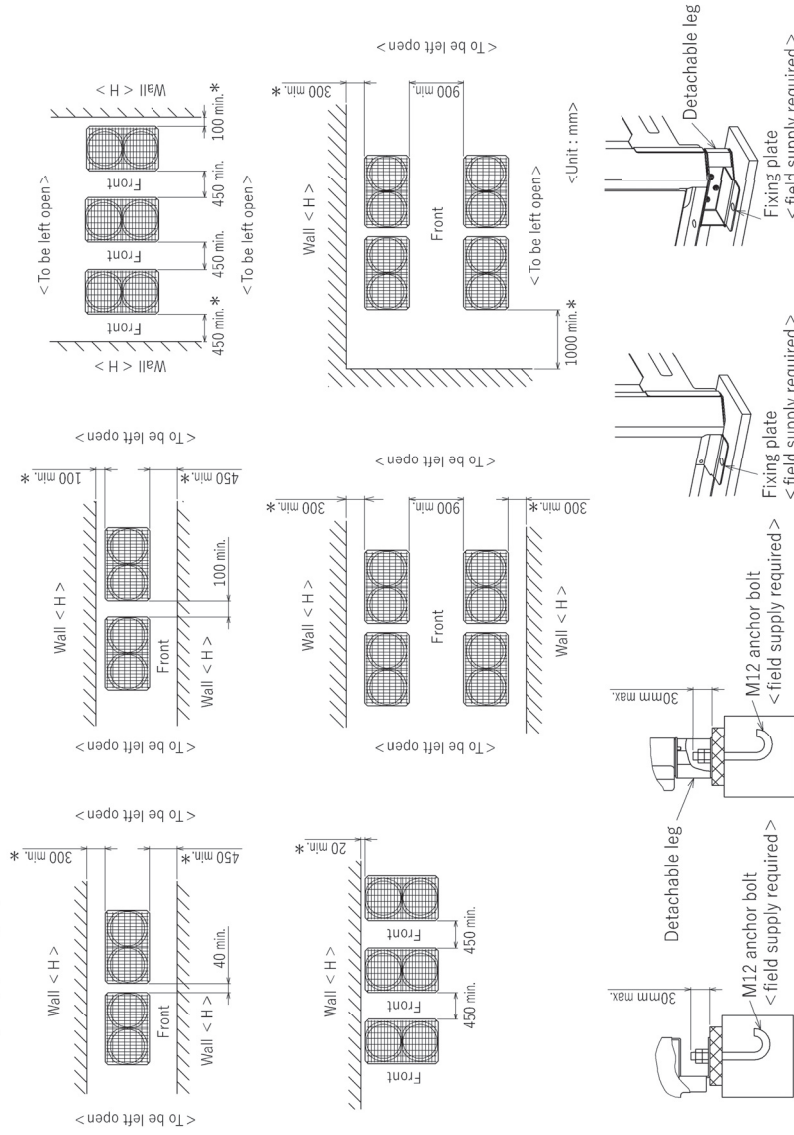

Fig. A(without detachable legs)

Fig. B(with detachable legs)

Fig. C(without detachable legs)

Fig. D(with detachable legs)

PURY-EM400, 450, 500, 550, 600YSXM-A/TR (-BS)

Unit: mm

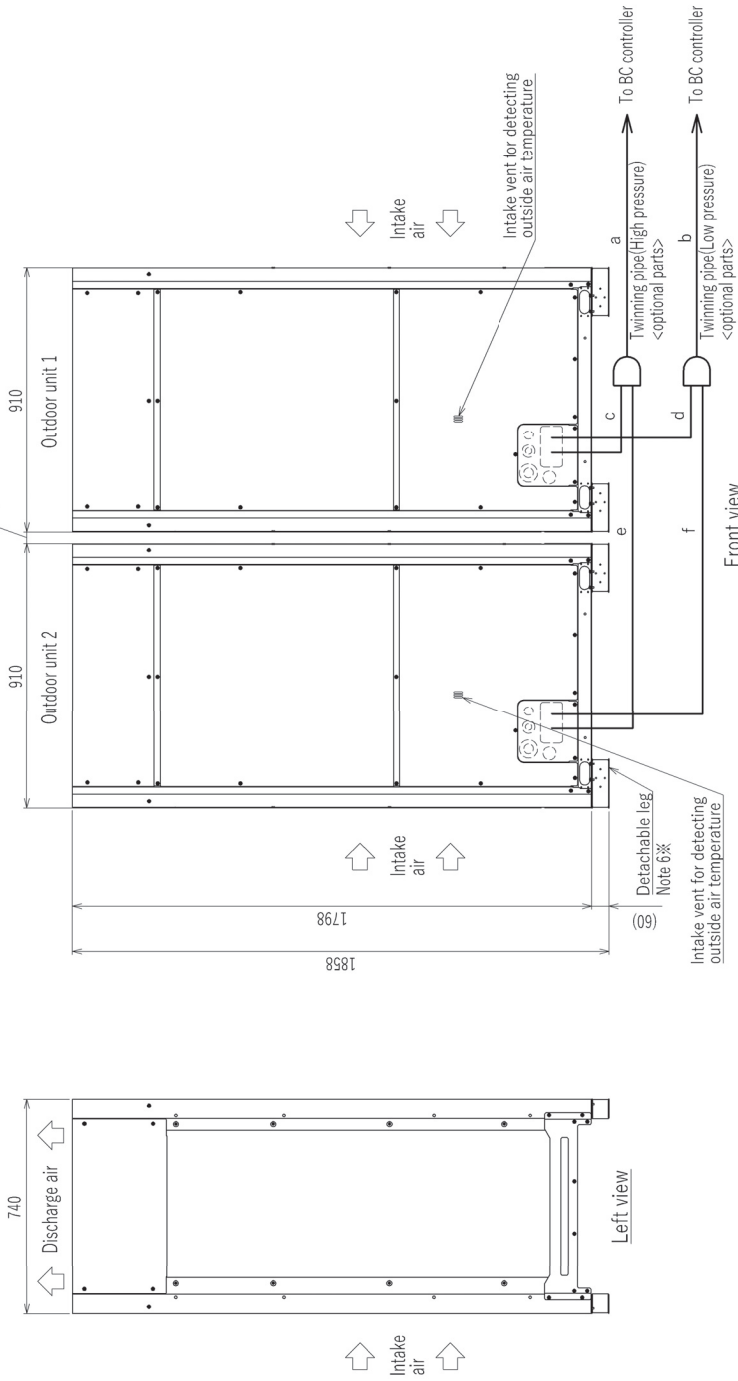

Twinning pipe connection size

Package unit name	PURY-EM400YSXM-A/TR(-BS)	PURY-EM450YSXM-A/TR(-BS)	PURY-EM500YSXM-A/TR(-BS)	PURY-EM550YSXM-A/TR(-BS)	PURY-EM600YSXM-A/TR(-BS)
Outdoor unit 1	PURY-EM200YSXM-A/TR(-BS)	PURY-EM250YSXM-A/TR(-BS)	PURY-EM300YSXM-A/TR(-BS)	PURY-EM350YSXM-A/TR(-BS)	PURY-EM300YSXM-A/TR(-BS)
Outdoor unit 2	PURY-EM200YSXM-A/TR(-BS)	PURY-EM250YSXM-A/TR(-BS)	PURY-EM250YSXM-A/TR(-BS)	PURY-EM250YSXM-A/TR(-BS)	PURY-EM300YSXM-A/TR(-BS)
Outdoor Twinning Kit (optional parts)	CMY-R100VBK4	CMY-R100VBK4	CMY-R100VBK4	CMY-R100VBK4	CMY-R100VBK4
BC controller					
~Twinning pipe a	φ 22.2	φ 22.2	φ 22.2 (φ 28.53)	* φ 22.2 (φ 28.58)	* φ 22.2 (φ 28.58)
~Twinning pipe b	φ 28.58	φ 28.58	φ 28.58	φ 28.58	φ 28.58
~Twinning pipe c	φ 15.88	φ 19.05	φ 19.05	φ 19.05	φ 19.05
~Outdoor unit 1	φ 22.2	φ 22.2	φ 22.2	φ 22.2	φ 22.2
~Twinning pipe d	φ 15.88	φ 15.88	φ 19.05	φ 19.05	φ 19.05
~Outdoor unit 2	φ 19.05	φ 19.05	φ 22.2	φ 22.2	φ 22.2
~Twinning pipe e					
~Twinning pipe f					

*When the piping length is 65m or longer, use the φ28.58 pipe for the part that exceeds 65m.

1. Connect the pipes as shown in the figure above. Refer to the table above for the pipe size.
2. Twinning pipes must be installed horizontally using a level vessel.
3. Be sure to see the Installation Manual for details of Twinning pipe installation.
3. The pipe section before the Twinning pipe (section "a" and "b" in the figure) must have at least 500mm of straight section (* including the straight pipe that is supplied with the Twinning pipe).
4. Only use the Twinning pipe by Mitsubishi (optional parts).
5. Do not block the intake vent for detecting outside air temperature.
6. The detachable leg can be removed at site.

PURY-EM650YSXM-A/TR (-BS)

Unit: mm

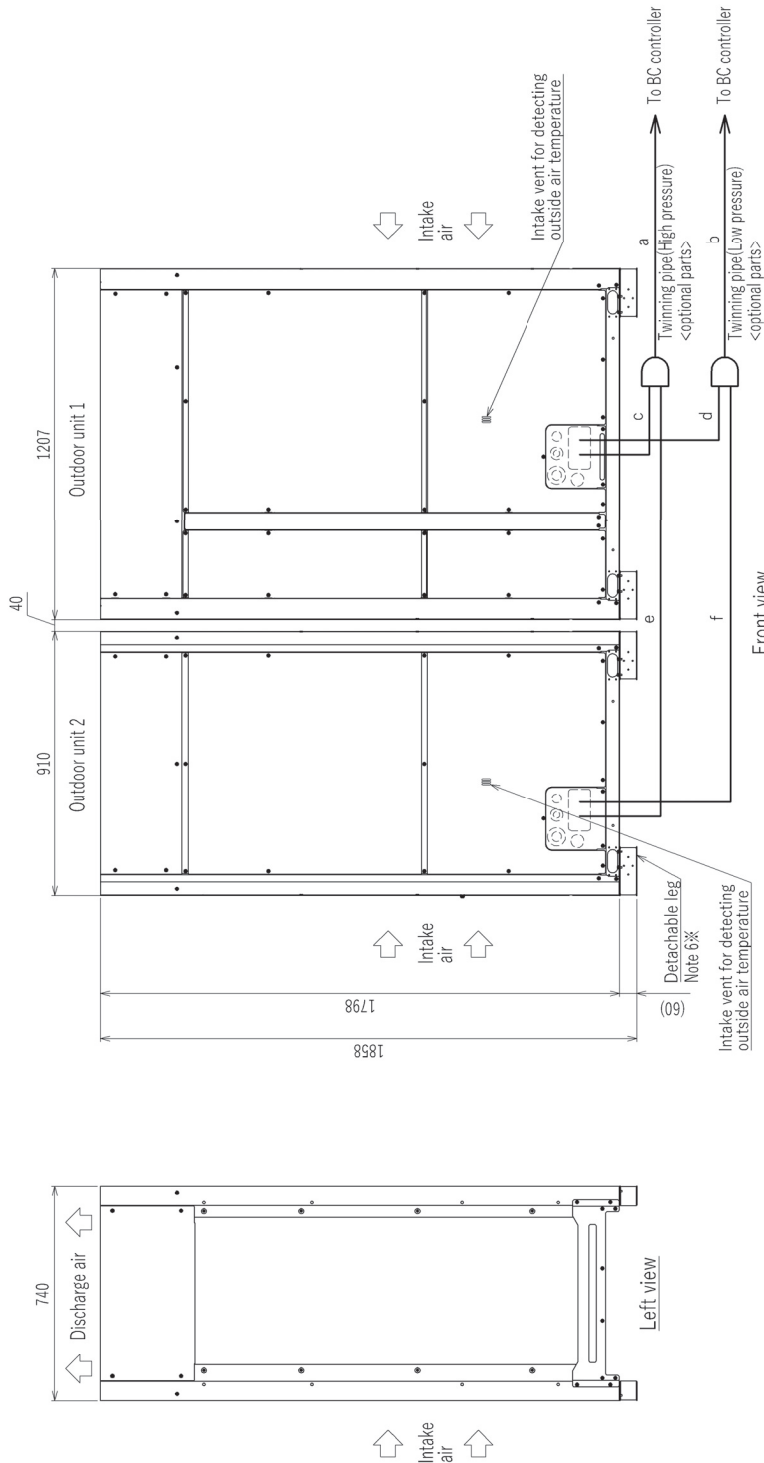

Twinning pipe connection size

Package unit name	PURY-EM650YSXM-A/TR(-BS)	
Component unit name	Outdoor unit 1	PURY-EM350YXM-A/TR(-BS)
	Outdoor unit 2	PURY-EM300YXM-A/TR(-BS)
Outdoor Twinning Kit (optional parts)	CMY-R100VBK4	
BC controller	High pressure	a φ28.58
	Low pressure	b φ28.58
Twinning pipe	High pressure	c φ19.05
	Low pressure	d φ28.58
Twinning pipe	High pressure	e φ19.05
	Low pressure	f φ22.2

- Note 1. Connect the pipes as shown in the figure above. Refer to the table above for the pipe size.
2. Twinning pipes must be installed horizontally using a level vessel.
3. Be sure to see the Installation Manual for details of Twinning pipe installation.
4. The pipe section before the Twinning pipe (section "a" and "b" in the figure) must have at least 500mm of straight section (* including the straight pipe that is supplied with the Twinning pipe).
5. Only use the Twinning pipe by Mitsubishi (optional parts).
6. Do not block the intake vent for detecting outside air temperature.
7. The detachable leg can be removed at site.

PURY-EM700, 750, 800, 850, 900, 950, 1000YSXM-A/TR (-BS)

Unit: mm

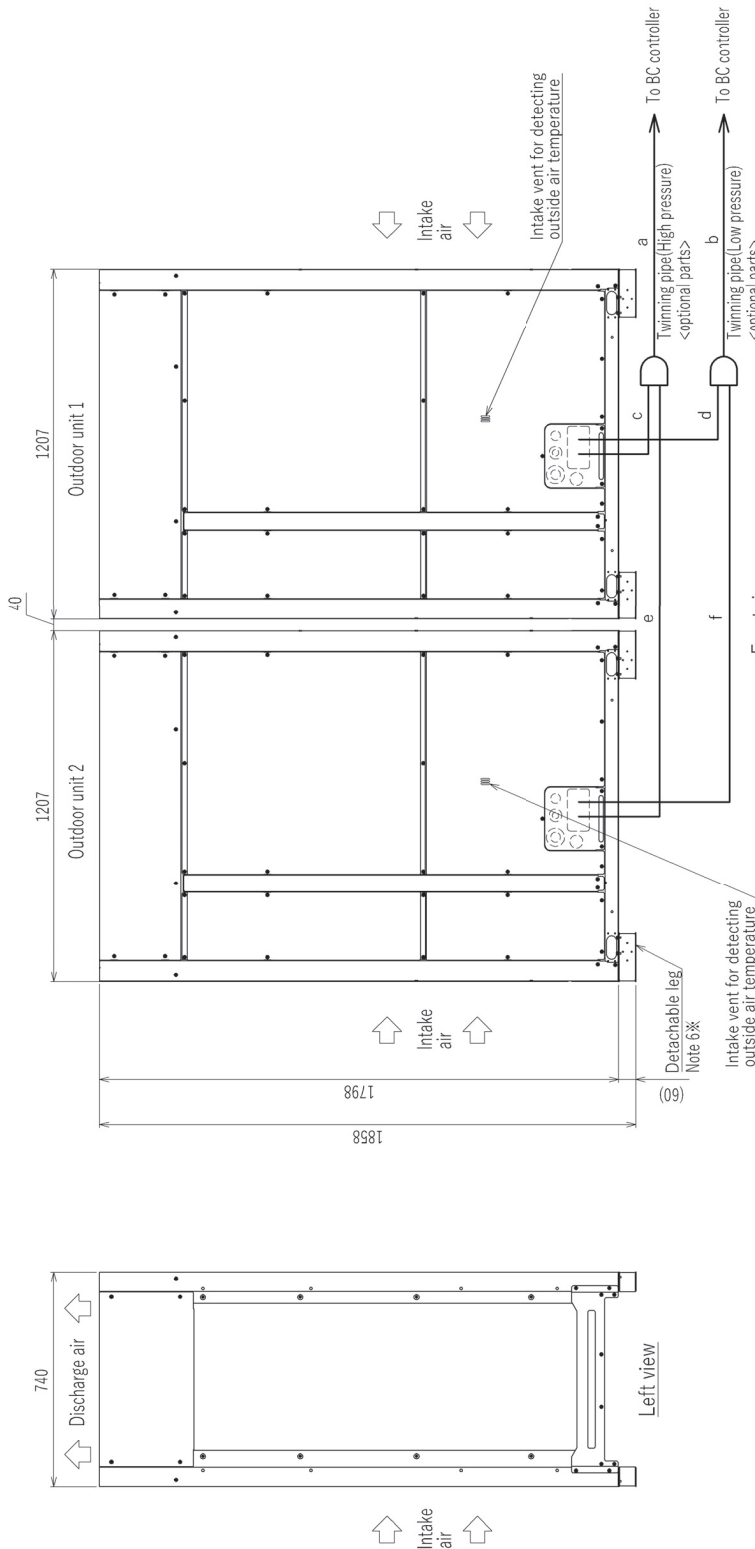

Twinning pipe connection size

Package unit name	PURY-EM700YSXM-A/TR(-BS)	PURY-EM750YSXM-A/TR(-BS)	PURY-EM800YSXM-A/TR(-BS)	PURY-EM850YSXM-A/TR(-BS)	PURY-EM900YSXM-A/TR(-BS)	PURY-EM950YSXM-A/TR(-BS)	PURY-EM1000YSXM-A/TR(-BS)
Outdoor unit 1	PURY-EM350YSXM-A/TR(-BS)	PURY-EM400YSXM-A/TR(-BS)	PURY-EM450YSXM-A/TR(-BS)	PURY-EM500YSXM-A/TR(-BS)	PURY-EM550YSXM-A/TR(-BS)	PURY-EM600YSXM-A/TR(-BS)	PURY-EM650YSXM-A/TR(-BS)
Outdoor unit 2	PURY-EM350YSXM-A/TR(-BS)	PURY-EM400YSXM-A/TR(-BS)	PURY-EM450YSXM-A/TR(-BS)	PURY-EM500YSXM-A/TR(-BS)	PURY-EM550YSXM-A/TR(-BS)	PURY-EM600YSXM-A/TR(-BS)	PURY-EM650YSXM-A/TR(-BS)
Outdoor Twinning Kit (optional parts)	CMY-R200VBK4	CMY-R200VBK4	CMY-R200VBK4	CMY-R200VBK4	CMY-R200VBK4	CMY-R200VBK4	CMY-R200VBK4
BC controller							
~Twinning pipe	High pressure a φ 28.58	High pressure a φ 34.93	High pressure a φ 34.93	High pressure a φ 41.28	High pressure a φ 41.28	High pressure a φ 41.28	High pressure a φ 41.28
~Twinning pipe	Low pressure b φ 19.05	Low pressure b φ 22.2	Low pressure b φ 22.2	Low pressure b φ 22.2	Low pressure b φ 22.2	Low pressure b φ 22.2	Low pressure b φ 22.2
~Outdoor unit 1	High pressure c φ 28.58	High pressure c φ 28.58	High pressure c φ 28.58	High pressure c φ 28.58	High pressure c φ 28.58	High pressure c φ 28.58	High pressure c φ 28.58
~Outdoor unit 2	High pressure d φ 19.05	High pressure d φ 22.2	High pressure d φ 22.2	High pressure d φ 22.2	High pressure d φ 22.2	High pressure d φ 22.2	High pressure d φ 22.2
~Outdoor unit 1	Low pressure e φ 28.58	Low pressure e φ 28.58	Low pressure e φ 28.58	Low pressure e φ 28.58	Low pressure e φ 28.58	Low pressure e φ 28.58	Low pressure e φ 28.58
~Outdoor unit 2	Low pressure f φ 28.58	Low pressure f φ 28.58	Low pressure f φ 28.58	Low pressure f φ 28.58	Low pressure f φ 28.58	Low pressure f φ 28.58	Low pressure f φ 28.58

Note 1. Connect the pipes as shown in the figure above. Refer to the table above for the pipe size.

Note 2. Twinning pipes must be installed horizontally using a level vessel.

Note 3. Be sure to see the Installation Manual for details of Twinning pipe installation.

Note 4. The pipe section before the Twinning pipe (section "a" and "b" in the figure) must have at least 500mm of straight section

Note 5. (* including the straight pipe that is supplied with the Twinning pipe).

Note 6. Only use the Twinning pipe by Mitsubishi (optional parts).

Note 7. Do not block the intake vent for detecting outside air temperature.

Note 8. The detachable leg can be removed at site.