

User manual  
(Original instructions)

EN

**Panasonic**<sup>®</sup>

N421162A - Rev.00 - 11/2024

**Jet Air Stream**

P-VTVF\*\* series

---

*First of all, we would like to thank you for having chosen one of our units.*

*As you will realise, you have made a winning choice by purchasing a product that represents the state of the art in domestic air-conditioning technology.*

*Thanks to the product you have purchased and by following the suggestions in this manual, you will benefit from optimal environmental conditions with the lowest possible energy investment.*

*Panasonic Corporation*

## Compliance

This unit complies with European directives:

- Low Voltage Directive 2014/35/EU by transposition of the following technical standards: EN 60335-1:2012 + EN 60335-2-40:2003
- EMC Directive 2014/30/EU, by transposition of technical standards: EN 55014-1:2017 + EN 55014-2:2015 + EN 61000-3-2:2014 + EN 61000 3-3:2013
- RoHS Directive 2011/65/EU by transposition of the following technical standards: EN 50581:2012
- European ErP Ecodesign Regulation No. 1254/2014

## Markings



---

# CONTENTS

Compliance . . . . . 2

**1. General information . . . . . 4**

1.1 About the manual . . . . . 4

1.2 Disposal . . . . . 5

**2. Control panel - Interface . . . . . 6**

2.1 Interface . . . . . 6

**4. Control panel - Operation. . . . . 7**

4.1 Basic menu . . . . . 7

4.2 Advanced menu . . . . . 9

# 1. GENERAL INFORMATION

## 1.1 About the manual

This manual was written to provide all the explanations for the correct management of the appliance.

- ⚠ This instruction manual is an integral part of the appliance and must therefore be kept in a safe place and must ALWAYS accompany the appliance even if it is passed on to another owner or user, or transferred to another plant. If it is damaged or lost, download a copy from the website.
- ⚠ Read this manual carefully before proceeding with any operation and follow the instructions in the individual chapters.
- ⚠ Specific warnings are given in each chapter of the document and should be read before starting operations.
- ⚠ The manufacturer accepts no liability for damage to persons or property resulting from failure to observe the regulations contained in this booklet.
- ⚠ This document is confidential under the terms of the law and may not be reproduced or passed on to third parties without the express authorisation of the company.

### Editorial pictograms

The pictograms in the following chapter provide quick and unambiguous information necessary for the correct and safe use of the machine.

#### Related to safety

##### ⚠ High risk warning (bold text)

- The operation described above presents a risk of serious physical injury, fatality, major damage to the appliance and/or to the environment if not carried out in compliance with safety regulations.

##### ⚠ Low risk warning (plain text)

- The operation described above presents a risk of minor physical injury or minor damage to the appliance and/or to the environment if not carried out in compliance with safety regulations.

##### ⊘ Prohibition (normal text)

- Marks actions that absolutely must not be done.

##### ⓘ Important information (bold text)

- This indicates important information that must be taken into account during the operations.

#### In the texts

##### Purpose of the actions

- ▶ Actions required

*Expected responses following an action*

- Lists

#### In the figures

- 1 The numbers indicate the individual components.

A Capital letters indicate a combination of components and dimensions.

- ① The white numbers in black marks indicate a series of actions to be carried out in sequence.
- Ⓐ The black letter in white identifies an image when there are several images in the same figure.

### Pictograms on the product

Symbols are used in some parts of the appliance:

#### Related to safety



##### Read the instruction manual

Read the instructions carefully before performing any operation on the appliance.



##### Instruction manual

Read the information available in the technical documentation of the appliance.



##### Attention electrical hazard

- Warns relevant personnel of the presence of electricity and the risk of electric shock.

### Recipients

#### User

Non-expert person capable of operating the product in safe conditions for people, for the product itself and the environment, interpreting an elementary diagnostic of faults and abnormal operating conditions, carrying out simple adjustment, checking and maintenance operations.

#### Installer

Expert person qualified to position and connect (hydraulically, electrically, etc.) the unit to the plant; this person is responsible for handling and correct installation according to the instructions provided in this manual and the national standards currently in force.

#### Service

Expert and qualified person authorised directly by the manufacturer to carry out all routine and supplementary maintenance operations, as well as every adjustment, check, repair and replacement of parts necessary during the life of the unit itself.

### Organisation of the manual

The manual is divided into sections each dedicated to one or more target groups.

#### General information

It addresses all recipients.

It contains general information and important warnings that should be known before installing and using the appliance.

**Product presentation**

It addresses all recipients.

It contains information to identify the product, its components, compatible accessories, and its intended use.

**Usage**

It is addressed solely and exclusively to the User.

It contains all the necessary information for the user to operate the device.

**Menu structure**

It is addressed solely and exclusively to the Installer and the Technical Assistance Center.

It contains the menu structure of the control panel, operational parameters, input and output states, alarms, and installer parameters.

**Functions**

It is addressed solely and exclusively to the Installer and the Technical Assistance Center.

It contains sections dedicated to different types of units that use the same control panel, with specific information for that pairing.

**Faults and remedies**

It is addressed solely and exclusively to the Technical Assistance Center.

It contains anomalies and remedies related to the product.

**1.2 Disposal**

The symbol on the product or packaging indicates that the product should not be treated as normal household waste. Instead, it should be taken to an appropriate collection point for recycling of electrical, electronic, and battery equipment.

Proper disposal of this product avoids harm to humans and the environment and promotes the reuse of valuable raw materials.

For more detailed information about the recycling of this product, contact your local city office, your household waste disposal service or the shop where you purchased the product.

Illegal disposal of the product by the user involves the application of the administrative sanctions provided for by the regulations in force.

This provision is only valid in the EU Member States.

⚠ Avoid disassembling the appliance yourself.

⚠ **Contact an authorised Technical Assistance Centre to disassemble the appliance.**



This symbol could be used in combination with a chemical symbol.

In such case, it complies with the requirements set by the directive for the chemical substance involved.

## 2. CONTROL PANEL - INTERFACE

### 2.1 Interface

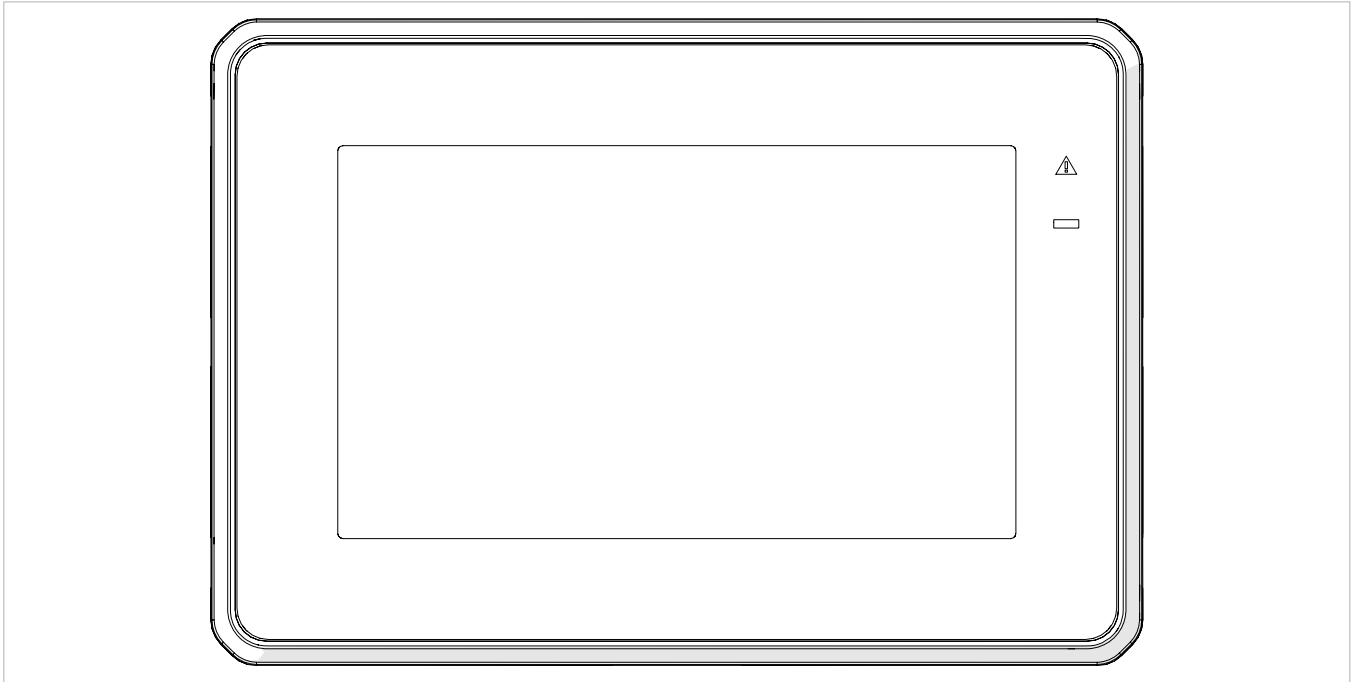

#### Description

The electronic control panel with a touch interface for wall installation allows:

- adjustment of the room temperature
- management of the main functions of the device
- temperature measurement
- adjustment of the fan speed

Features:

- display of the return air temperature
- internal memory with data storage even in the event of abnormal shutdown or power failure

the multi-unit configuration allows linking multiple units under a single command, offering two connection options:

- modbus, cable connection via Modbus for each individual unit
- Wi-Fi, module for radio communication between units (optional)

⚠ After 300 seconds from the last action, the brightness of the control panel reduces. Pressing any key restores the maximum brightness.

## 4. CONTROL PANEL - OPERATION

### 4.1 Basic menu

1.	Unit status
2.	Date and time
3.	Disabled

4.	Disabled
5.	Detected temperature
6.	Fan speed

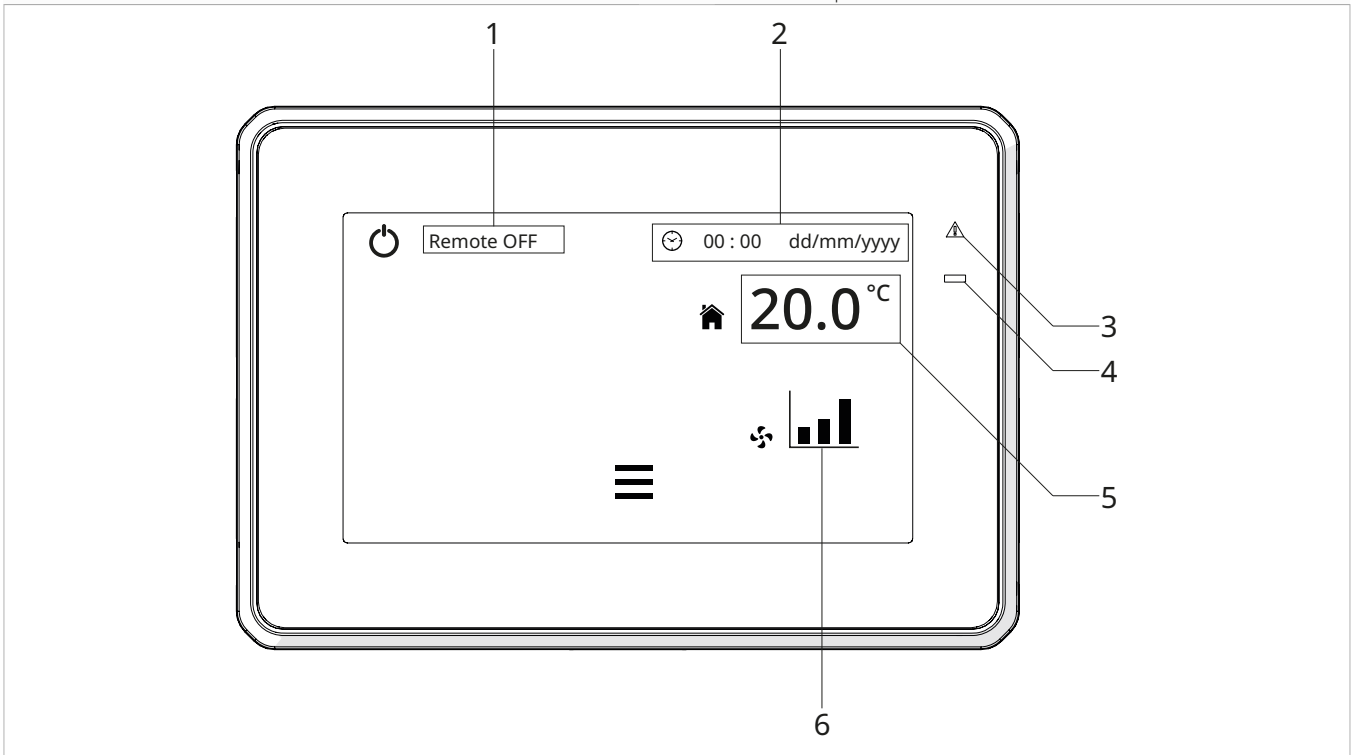

Status and alarms shown on the display.

	It allows turning the unit on/off from the keypad
	Selection of the desired room temperature
	Fan speed selection
	Access to the advanced menu

If there is a remote device for turning the unit on/off (switch or timer), the use of the control panel will only be possible when the contact is closed.

#### Switching the unit on and off

Before switching on:

- Make sure that the control panel is connected to the power supply.
- If there is a main switch on the power supply line, switch the system on by pressing the switch.

##### Activation

- ▶ press and hold the button for approx. 2 seconds  
when released, the unit powers on

##### Deactivation



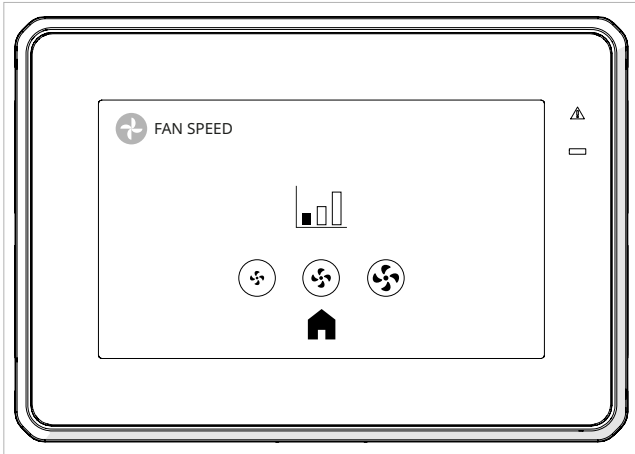

- ▶ press and hold the button for approx. 2 seconds  
when released, the unit powers off

### Fan speed selection



#### To select the desired fan speed

- ▶ hold down the button  the available speeds are:

-   Speed 1
-   Speed 2
-   Speed 3

### Setting desired temperature

1. Detected temperature
2. Set point set

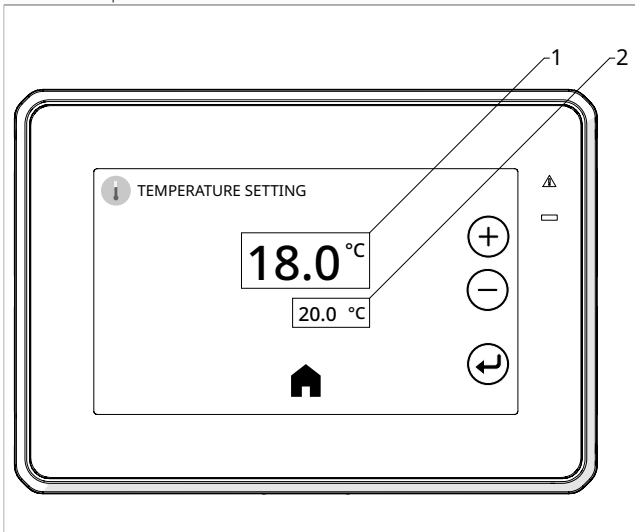

#### To select the desired temperature

- ▶ hold down the button 

#### To change the temperature set point

- ▶ hold down the button 
- ▶ operate the  and  buttons to decrease or increase the desired value  
*the value shown on the display changes*

#### To confirm

- ▶ hold down the button 

### Alarm display and reset



From the main display, if there is an alarm, you can access the ongoing alarms display by pressing the 'alarm' button; the alarm status can be:

- Active: if the cause of the alarm persists, in this case, the alarm cannot be reset, and the ongoing alarm type will be described
- Reset: the cause that triggered the alarm is no longer present, and the alarm can be reset

#### To reset the ongoing alarms

- ▶ Press reset



## 4.2 Advanced menu

- 1. User functions
- 2. Installer functions

- 3. Service functions

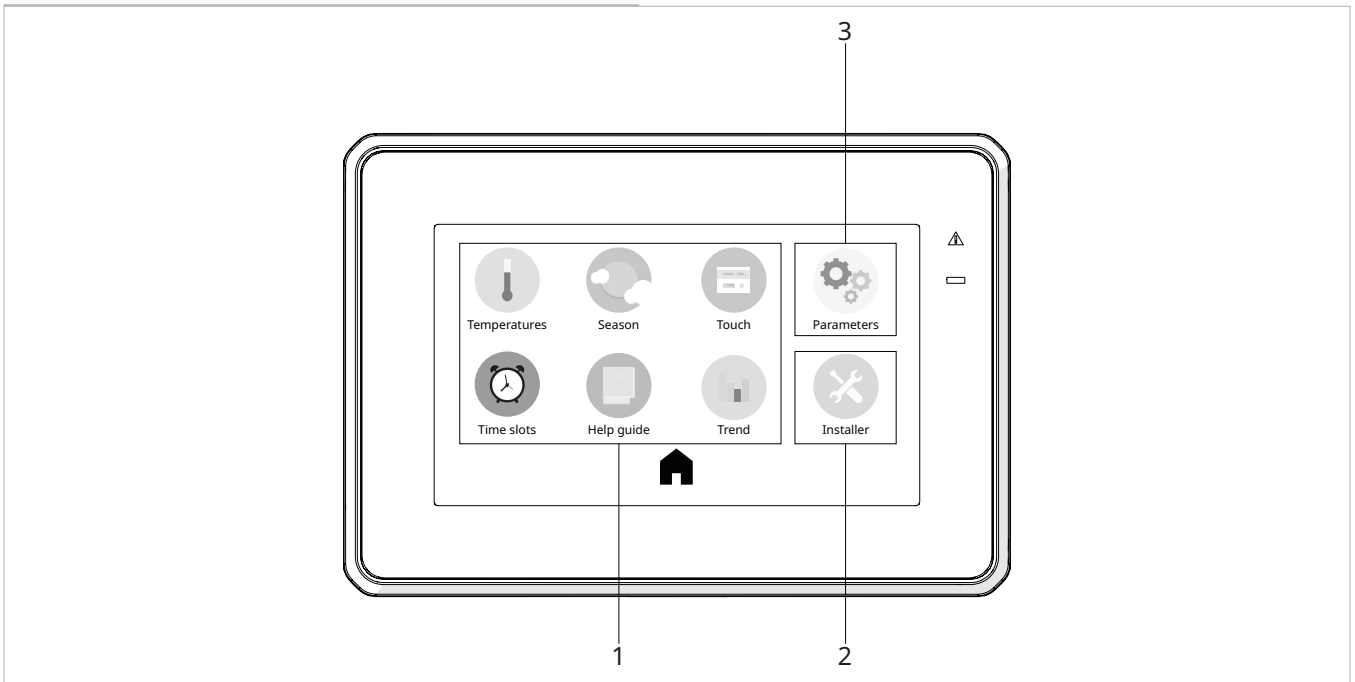

### To access the advanced menu

- ▶ hold down the button

### To return to the basic menu

- ▶ hold down the button

## User functions

### Temperatures

#### To access the temperature and status menu



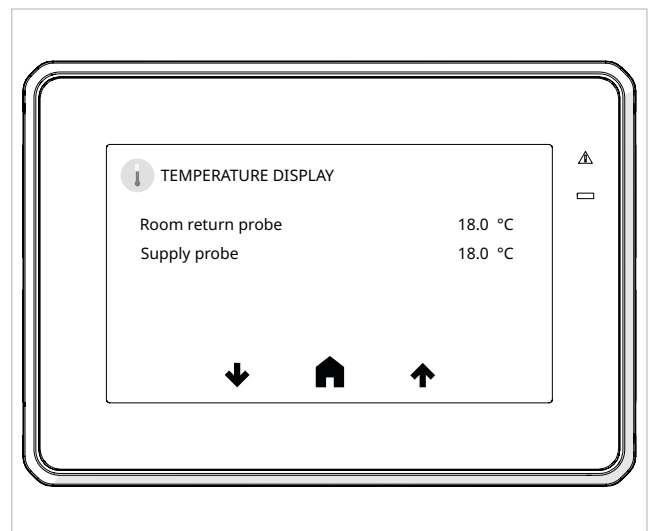
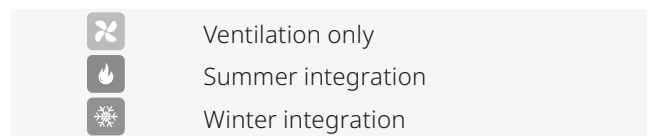
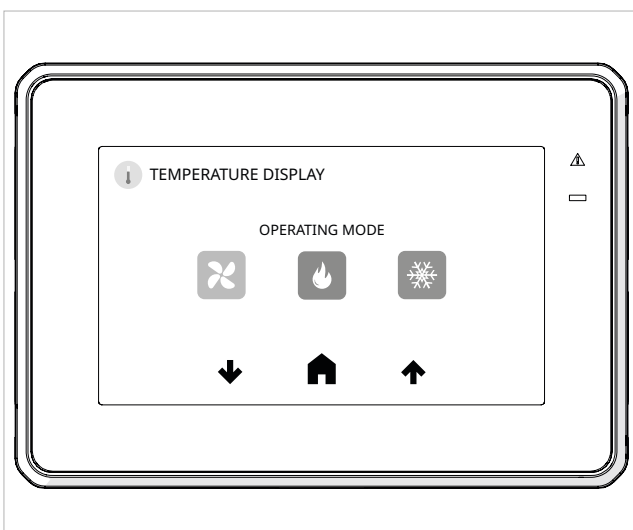

- ▶ hold down the button

#### To navigate from one screen to another

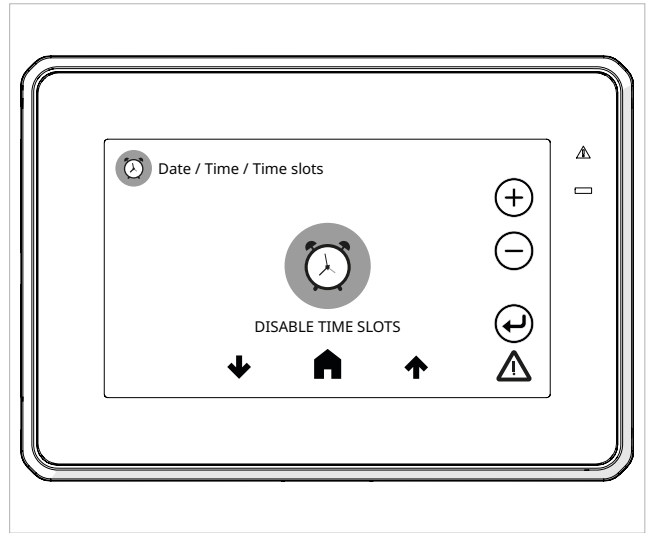
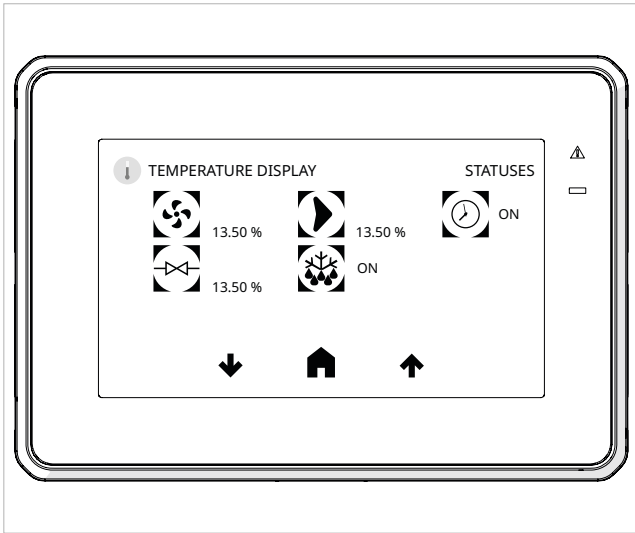
- ▶ press the buttons and







 Fan status in %  
 External unit status in %  
 Motorized nozzle status in %  
 Defrost status of the outdoor unit  
 Time band status

**To return to the main menu**  
 ► hold down the button 

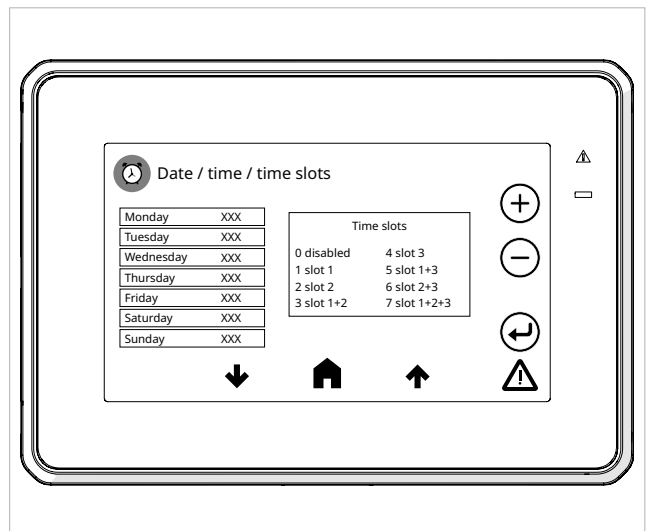
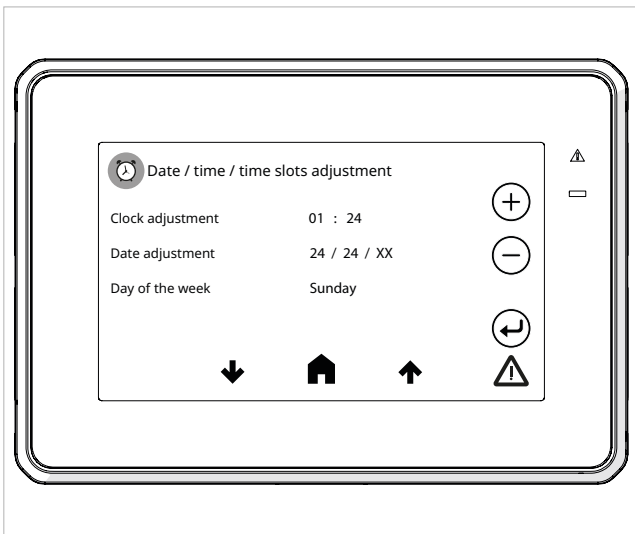
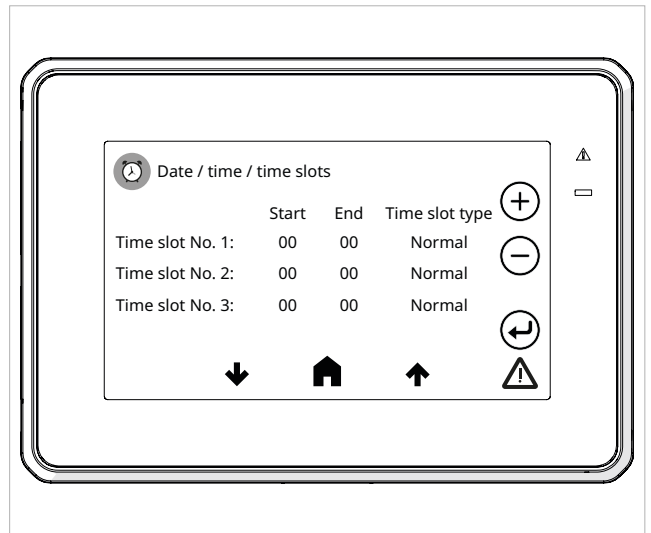
**Time bands**



**To access the clock menu**

- ▶ hold down the button 

**To set the desired value**

- ▶ select the value

**To enable editing**

- ▶ hold down the button 
- ▶ operate the  and  buttons to decrease or increase the desired value

**To confirm**

- ▶ hold down the button 

By enabling and setting time slots, it is possible to turn on/off the controller and enable eco/reduced operation.

**To set the time bands**

- ▶ set the starting value
- ▶ set the ending value
- ▶ set the type of band:

- total shutdown
- reduction mode
- ▶ assign the desired band type for each day of the week:

- 0 = time slot operation disabled
- 1 = operation enabled for time slot 1
- 2 = operation enabled for time slot 2
- 3 = operation enabled for time slots 1 + 2
- 4 = operation enabled for time slot 3
- 5 = operation enabled for time slots 1 + 3
- 6 = operation enabled for time slots 2 + 3
- 7 = operation enabled for time slots 1 + 2 + 3

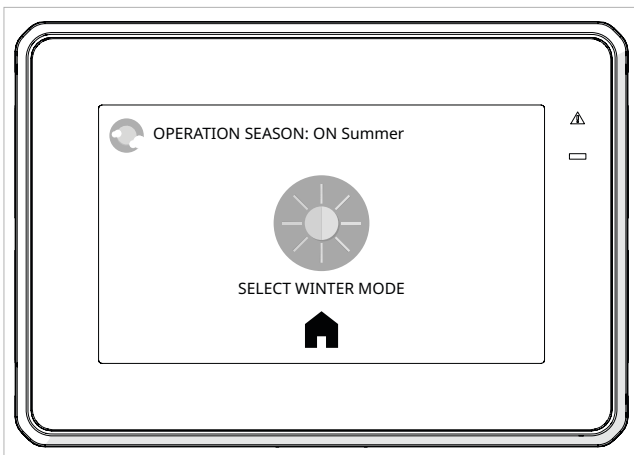
**Season****To access the temperature and status menu**

- ▶ hold down the button 

**Select the operating mode**  
*the available modes are:*



Summer operation



Winter operation

- ⚠ In the standard unit, automatic operation is provided.
- ⚠ If the seasonal change is expected from an external digital input, it won't be possible to change the season via the command.

**To return to the main menu**

- ▶ hold down the button 

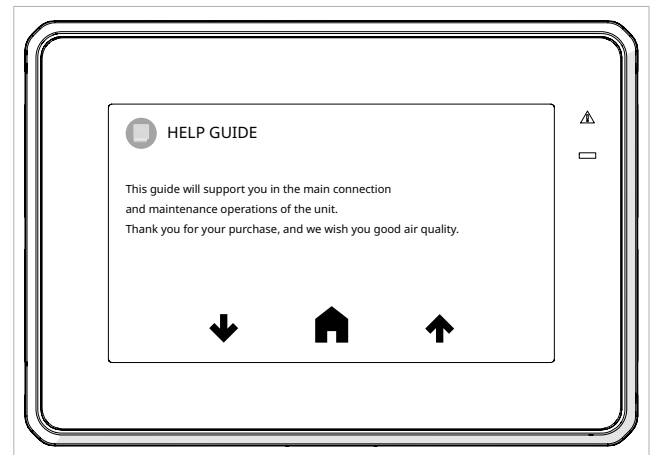
**Online guide****To access the online guide menu**

- ▶ hold down the button 

The menu displays and describes the main operation and maintenance activities of the unit, assisting in its management and proper functioning.

**To return to the main menu**

- ▶ hold down the button 

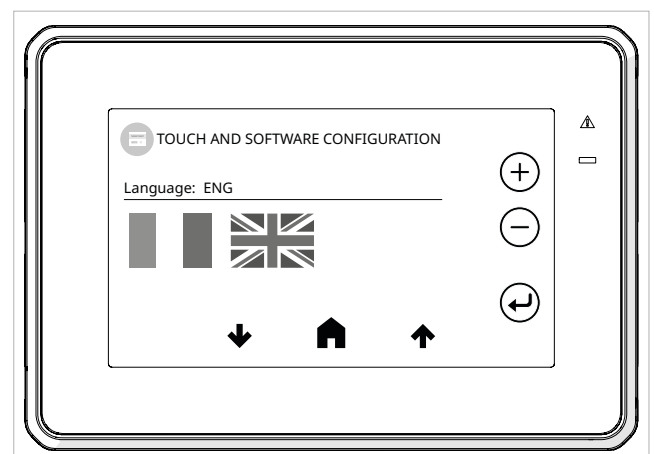
**Touch (local settings)**

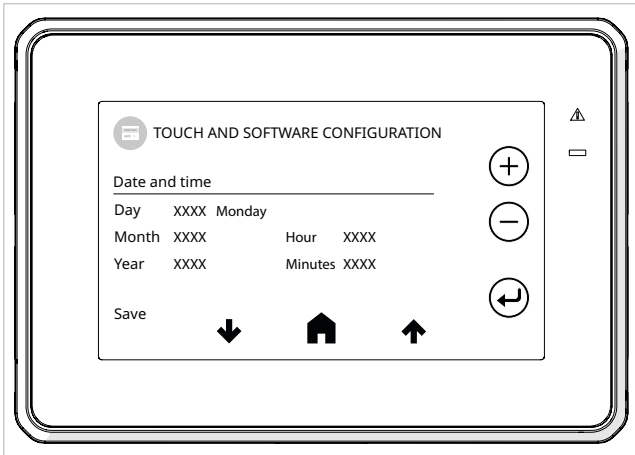

**To access the touch menu and software**

- ▶ hold down the button

The menu includes settings for time and date, display contrast, backlight of the touch display, and the ability to set the language for display operation.

**To set the desired value**

- ▶ Select the parameter using the
- ▶ operate the and buttons to decrease or increase the desired value

**To confirm**

- ▶ hold down the button

**To return to the main menu**

- ▶ hold down the button
- ① Backlight refers to the duration during which the display remains on without the pressing of any button.
- ② The software-loaded languages can be selected through the flags available in the menu.

**Trend (alarm history)**

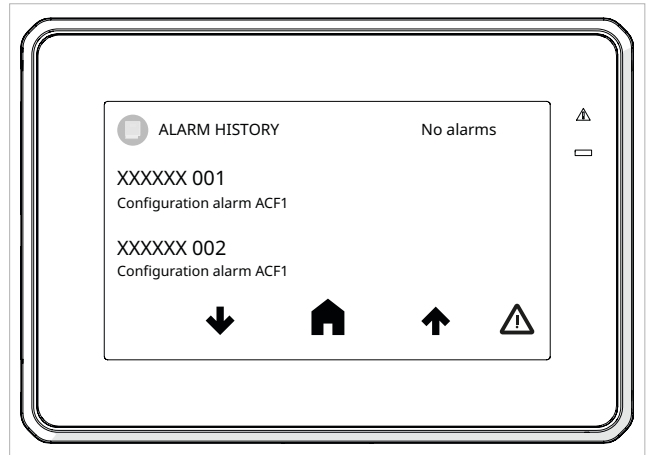
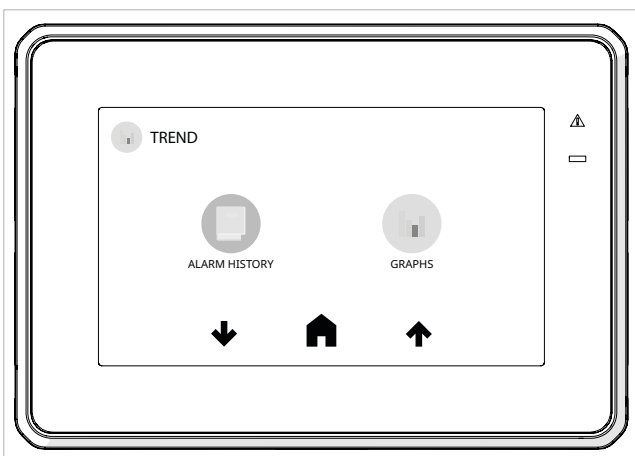

**To access the trend menu**

- ▶ hold down the button

**To display unit alarms sequentially**

- ▶ hold down the button

**To display temperature graphs**

- ▶ hold down the button

**To return to the main menu**

- ▶ hold down the button







# Panasonic<sup>®</sup>

Panasonic Corporation  
1006 Kadoma, Kadoma City, Osaka, Japan