

Air-Conditioners

INDOOR UNIT

PFFY-P-VCM-E

PFFY-P-VEM-E

OPERATION MANUAL

For safe and correct use, please read this operation manual thoroughly before operating the air-conditioner unit.

BEDIENUNGSHANDBUCH

Zum sicheren und einwandfreien Gebrauch der Klimaanlage dieses Bedienungshandbuch vor Inbetriebnahme gründlich durchlesen.

MANUEL D'UTILISATION

Pour une utilisation correcte sans risques, veuillez lire le manuel d'utilisation en entier avant de vous servir du climatiseur.

BEDIENINGSHANDLEIDING

Voor een veilig en juist gebruik moet u deze bedieningshandleiding grondig doorlezen voordat u de airconditioner gebruikt.

MANUAL DE INSTRUCCIONES

Lea este manual de instrucciones hasta el final antes de poner en marcha la unidad de aire acondicionado para garantizar un uso seguro y correcto.

ISTRUZIONI DI FUNZIONAMENTO

Leggere attentamente questi istruzioni di funzionamento prima di avviare l'unità, per un uso corretto e sicuro della stessa.

ΕΓΧΕΙΡΙΔΙΟ ΟΔΗΓΙΩΝ ΧΡΗΣΕΩΣ

Για ασφάλεια και σωστή χρήση, παρακαλείστε διαβάσετε προσεκτικά αυτό το εγχειρίδιο χρήσεως πριν θέσετε σε λειτουργία τη μονάδα κλιματισμού.

MANUAL DE OPERAÇÃO

Para segurança e utilização correctas, leia atentamente o manual de operação antes de pôr a funcionar a unidade de ar condicionado.

DRIFTSMANUAL

Læs venligst denne driftsmanual grundigt før airconditionanlægget betjenes af hensyn til sikker og korrekt brug.

OPERATÖRSMANUAL

Läs den här bruksanvisningen noga innan luftkonditioneringsenheten används, för säker och korrekt användning.

İŞLETME ELKİTABI

Emniyetli ve doğru biçimde nasıl kullanılacağını öğrenmek için lütfen klima cihazını işletmeden önce bu elkitabını dikkatle okuyunuz.

РЪКОВОДСТВО ЗА ЕКСПЛОАТАЦИЯ

За безопасна и правилна употреба, моля, прочетете внимателно това ръководство преди експлоатацията на климатизатора.

INSTRUKCJA OBSŁUGI

Przed rozpoczęciem użytkowania klimatyzatora dokładnie przeczytaj niniejszą instrukcję, w celu uzyskania informacji na temat bezpiecznego i prawidłowego korzystania z urządzenia.

INSTRUKSJONSHEFTE

For sikker og riktig bruk, skal du lese dette instruksjonsheftet nøye før du betjener klimaanlegget.

РУКОВОДСТВО ПО ЭКСПЛУАТАЦИИ

Для обеспечения правильного и безопасного использования следует ознакомиться с инструкциями, указанными в данном руководстве по эксплуатации, тщательным образом до того, как приступить к использованию кондиционера.

NÁVOD K OBSLUZE

Přečtěte si důkladně tento návod k obsluze před použitím klimatizační jednotky. Budete ji pak moci využívat bezpečně a správně.

NÁVOD NA POUŽITIE

Skôr, než začnete používať klimatizačnú jednotku, prečítajte si dôkladne návod na použitie, aby ste jednotku používali bezpečne a správne.

HASZNÁLATI KÉZIKÖNYV

A megfelelő és biztonságos használat érdekében, kérjük, hogy figyelmesen olvassa el a használati kézikönyvben leírtakat a légkondicionáló berendezés üzembe helyezésé előtt.

UPORABNIŠKI PRIROČNIK

Za varno in pravilno uporabo pred uporabo klimatske naprave pazljivo preberite ta uporabniški priročnik.

MANUAL CU INSTRUCȚIUNI DE FUNCȚIONARE

Pentru o utilizare corectă și sigură, vă rugăm să citiți cu atenție acest manual înainte de a pune în funcțiune unitatea de aer condiționat.

PRIRUČNIK ZA RUKOVANJE

Radi sigurne i ispravne uporabe, temeljito pročítajte ovaj priručnik prije rukovanja klimatizacijskim uređajem.

คู่มือการใช้งาน

เพื่อความปลอดภัยและการใช้งานที่ถูกต้อง โปรดอ่านคู่มือการใช้งานนี้อย่างละเอียดก่อนทำงานกับเครื่องปรับอากาศ

操作手冊

運轉本空調機之前，請仔細閱讀本操作手冊，以便安全正確地使用。

en

de

fr

nl

es

it

el

pt

da

sv

tr

bg

pl

no

ru

cs

sk

hu

sl

ro

hr

th

中

文

Controller interface

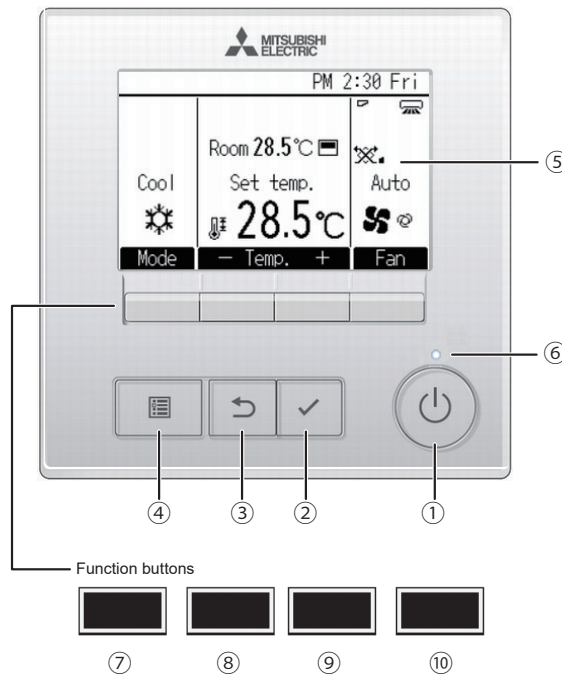

① [ON/OFF] button

Press to turn ON/OFF the indoor unit.

② [SELECT] button

Press to save the setting.

③ [RETURN] button

Press to return to the previous screen.

④ [MENU] button

Press to bring up the Main menu.

⑤ Backlit LCD

Operation settings will appear. When the backlight is off, pressing any button turns the backlight on and it will stay lit for a certain period of time depending on the screen.

When the backlight is off, pressing any button turns the backlight on and does not perform its function. (except for the [ON/OFF] button)

⑥ ON/OFF lamp

This lamp lights up in green while the unit is in operation. It blinks while the remote controller is starting up or when there is an error.

The functions of the function buttons change depending on the screen. Refer to the button function guide that appears at the bottom of the LCD for the functions they serve on a given screen. When the system is centrally controlled, the button function guide that corresponds to the locked button will not appear.

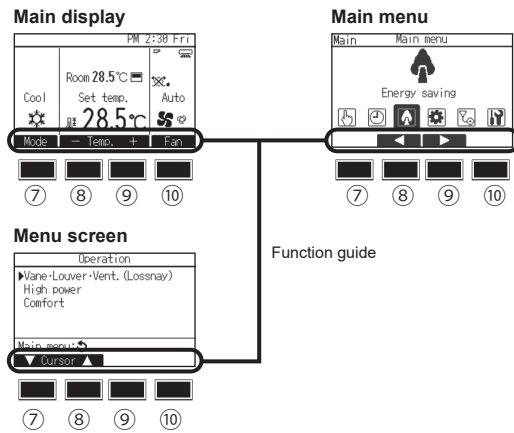

⑦ Function button [F1]

Main display: Press to change the operation mode.
Menu screen: The button function varies with the screen.

⑧ Function button [F2]

Main display: Press to decrease temperature.
Main menu: Press to move the cursor left.
Menu screen: The button function varies with the screen.

⑨ Function button [F3]

Main display: Press to increase temperature.
Main menu: Press to move the cursor right.
Menu screen: The button function varies with the screen.

⑩ Function button [F4]

Main display: Press to change the fan speed.
Menu screen: The button function varies with the screen.

Display

The main display can be displayed in two different modes: "Full" and "Basic."
The factory setting is "Full." To switch to the "Basic" mode, change the setting on the Main display setting.

Full mode

* All icons are displayed for explanation.

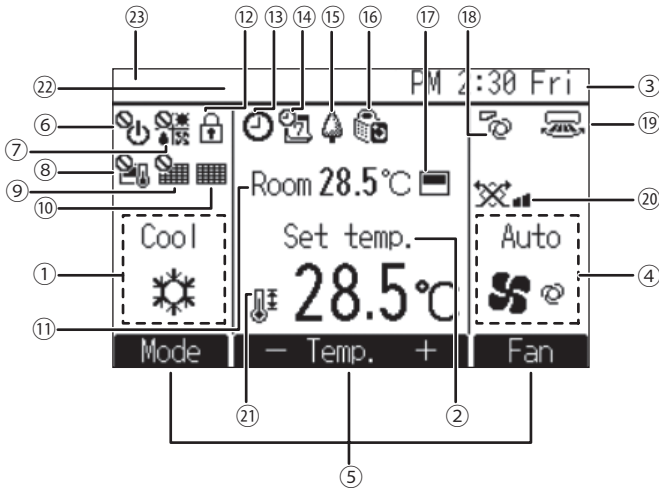

Basic mode

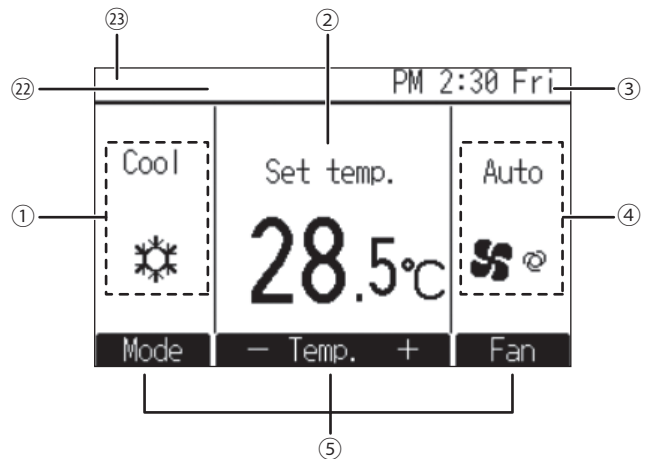

① Operation mode

② Preset temperature

③ Clock

See the Installation Manual.

④ Fan speed

⑤ Button function guide

Functions of the corresponding buttons appear here.



Appears when the ON/OFF operation is centrally controlled.



Appears when the operation mode is centrally controlled.



Appears when the preset temperature is centrally controlled.



Appears when the filter reset function is centrally controlled.



Indicates when filter needs maintenance.

⑪ Room temperature

See the Installation Manual.



Appears when the buttons are locked.



Appears when the On/Off timer, Night setback, or Auto-off timer function is enabled.

appears when the timer is disabled by the centralized control system.



Appears when the Weekly timer is enabled.



Appears while the units are operated in the energy-save mode. (Will not appear on some models of indoor units)



Appears while the outdoor units are operated in the silent mode.



Appears when the built-in thermistor on the remote controller is activated to monitor the room temperature (⑪).

appears when the thermistor on the indoor unit is activated to monitor the room temperature.



Indicates the vane setting.



Indicates the louver setting.



Indicates the ventilation setting.



Appears when the preset temperature range is restricted.

⑫ Centrally controlled

Appears for a certain period of time when a centrally-controlled item is operated.

⑬ Error display

An error code appears during the error.

* When an error code is displayed on the main display, an error is occurring but the indoor unit can keep its operation. Check the error code, and consult your dealer.

Most settings (except ON/OFF, mode, fan speed, temperature) can be made from the Main menu.

Contents

1. Safety precautions.....	4	3.4. Fan speed	8
1.1. Installation.....	4	4. The smart way to use.....	9
1.2. During operation	5	5. Caring for the machine	9
1.3. Disposing of the unit	5	5.1. Cleaning the indoor units and remote controllers	9
2. Names and functions of various parts.....	6	5.2. Cleaning the filter	9
3. How to operate.....	7	6. Troubleshooting.....	10
3.1. Turning ON/OFF.....	7	7. Installation, transferring works, and checking	11
3.2. Operation mode.....	7	8. Specifications	12
3.3. Set temperature	8		

Note



Fig. 1

This symbol mark is for related countries only.

This symbol mark is according to the directive 2012/19/EU Article 14 Information for users and Annex IX, and/or to the directive 2006/66/EC Article 20 Information for end-users and Annex II.

Your MITSUBISHI ELECTRIC product is designed and manufactured with high quality materials and components which can be recycled and/or reused. This symbol means that electrical and electronic equipment, batteries and accumulators, at their end-of-life, should be disposed of separately from your household waste. If a chemical symbol is printed beneath the symbol (Fig. 1), this chemical symbol means that the battery or accumulator contains a heavy metal at a certain concentration.

This will be indicated as follows: Hg: mercury (0.0005%), Cd: cadmium (0.002%), Pb: lead (0.004%)

In the European Union there are separate collection systems for used electrical and electronic products, batteries and accumulators.

Please, dispose of this equipment, batteries and accumulators correctly at your local community waste collection/recycling centre.

Please, help us to conserve the environment we live in!

1. Safety precautions

- ▶ Before operating the unit, make sure you read all the “Safety precautions”.
- ▶ “Safety precautions” lists important points about safety. Please be sure to follow them.

Symbols used in the text

⚠ Warning:

Describes precautions that should be observed to avoid the risk of injury or death to the user.

⚠ Caution:

Describes precautions that should be observed to prevent damage to the unit.

Symbols used in the illustrations

- ⊘ : Indicates an action that must be avoided.
- ⚠ : Indicates that important instructions must be followed.
- ⚡ : Indicates a part which must be grounded.
- ⚠ : Indicates that caution should be taken with rotating parts. (This symbol is displayed on the main unit label.) <Color: yellow>
- ⚠ : Beware of electric shock. (This symbol is displayed on the main unit label.) <Color: yellow>

⚠ Warning:

Carefully read the labels affixed to the main unit.

1.1. Installation

- ▶ After you have read this manual, keep it and the Installation Manual in a safe place for easy reference whenever a question arises. If the unit is going to be operated by another person, make sure that this manual is given to him or her.

⚠ Warning:

- The unit should not be installed by the user. Ask the dealer or an authorized company to install the unit. If the unit is installed improperly, water leakage, electric shock or fire may result.
- Use only accessories authorized by Mitsubishi Electric and ask your dealer or an authorized company to install them. If accessories are installed improperly, water leakage, electric shock or fire may result.
- The Installation Manual details the suggested installation method. Any structural alteration necessary for installation must comply with local building code requirements.
- Never repair the unit or transfer it to another site by yourself. If repair is performed improperly, water leakage, electric shock or fire may result. If you need to have the unit repaired or moved, consult your dealer.
- Keep the electric parts away from water (washing water) etc.
- It might result in electric shock, catching fire or smoke.

Note 1: When washing the Heat Exchanger and Drain Pan, ensure the Control Box, Motor and LEV remain dry, using a water proof covering.

Note 2: Never drain the washing water for the Drain Pan and the Heat Exchanger using the Drain Pump. Drain separately.

- This air conditioner is NOT intended for use by children or infirm persons without supervision.

- If the refrigeration gas blows out or leaks, stop the operation of the air conditioner, thoroughly ventilate the room, and contact your dealer.
- This appliance is not intended for use by persons (including children) with reduced physical, sensory or mental capabilities, or lack of experience and knowledge, unless they have been given supervision or instruction concerning use of the appliance by a person responsible for their safety.
- Children should be supervised to ensure that they do not play with the air conditioner.
- This appliance is intended to be used by expert or trained users in shops, in light industry and on farms, or for commercial use by lay persons.
- This appliance can be used by children aged from 8 years and above and persons with reduced physical, sensory or mental capabilities or lack of experience and knowledge if they have been given supervision or instruction concerning use of the appliance in a safe way and understand the hazards involved. Children shall not play with the appliance. Cleaning and user maintenance shall not be made by children without supervision.
- When installing or relocating, or servicing the air conditioner, use only the specified refrigerant (R410A) to charge the refrigerant lines. Do not mix it with any other refrigerant and do not allow air to remain in the lines. If air is mixed with the refrigerant, then it can be the cause of abnormal high pressure in the refrigerant line, and may result in an explosion and other hazards. The use of any refrigerant other than that specified for the system will cause mechanical failure or system malfunction or unit breakdown. In the worst case, this could lead to a serious impediment to securing product safety.
- Do not use a leak detection additive.
- Do not use refrigerant other than the type indicated in the manuals provided with the unit and on the nameplate.
 - Doing so may cause the unit or pipes to burst, or result in explosion or fire during use, during repair, or at the time of disposal of the unit.
 - It may also be in violation of applicable laws.
 - MITSUBISHI ELECTRIC CORPORATION cannot be held responsible for malfunctions or accidents resulting from the use of the wrong type of refrigerant.
- Do not use the unit in an unusual environment.
 - If the unit is used in areas exposed to large amounts of oil, steam, organic solvents, or corrosive gases (such as ammonia, sulfuric compounds, or acids), or areas where acidic/alkaline solutions or special chemical sprays are used frequently, it may significantly reduce the performance and corrode the internal parts, resulting in refrigerant leakage, water leakage, injury, electric shock, malfunction, smoke, or fire.

1) Outdoor unit

⚠ Warning:

- The outdoor unit must be installed on a stable, level surface, in a place where there is no accumulation of snow, leaves or rubbish.
- Do not stand on, or place any items on the unit. You may fall down or the item may fall, causing injury.

⚠ Caution:

- The outdoor unit should be installed in a location where air and noise emitted by the unit will not disturb the neighbours.

2) Indoor unit

⚠ Warning:

- The indoor unit should be securely installed. If the unit is loosely mounted, it may fall, causing injury.

⚠ Caution:

- Direct the air away from the walls and windows to prevent condensation.
- Do not use the air conditioner for special purposes (e.g. keeping food, animals, plants, precision devices, or art objects in a room).
 - Such items could be damaged or deteriorated.

[PFFY-P-VCM-E, PFFY-P-VEM-E series]

- Although the heat exchanger is coated with hydrophilic coating, sprays or detergents with volatile organic compounds (VOC) or water-repellant components may cause the heat exchanger fins to repel water. When the unit with such fins is operated in a high-temperature and high-humidity environment, condensation water on the fins may drip from the unit.

3) Remote controller

⚠ Warning:

- The remote controller should be installed in such a way that children cannot play with it.

4) Drain hose

⚠ Caution:

- Make sure that the drain hose is installed so that drainage can go ahead smoothly. Incorrect installation may result in water leakage, causing damage to furniture.

5) Power line, fuse or circuit breaker

⚠ Warning:

- Make sure that the unit is powered by a dedicated supply. Other appliances connected to the same supply could cause an overload.
- Make sure that there is a main power switch.
- Be sure to adhere to the unit's voltage and fuse or circuit breaker ratings. Never use a piece of wire or a fuse with a higher rating than the one specified.

6) Grounding

⚠ Caution:

- The unit must be properly grounded. Never connect the grounding wire to a gas pipe, water pipe, lightning conductor or telephone grounding wire. If the unit is not grounded properly, electric shock may result.
- Check frequently that the ground wire from the outdoor unit is properly connected to both the unit's ground terminal and the grounding electrode.

1.2. During operation

⚠ Warning:

- To reduce the risk of electric leakage, electric shock, wire shorting, malfunction, smoke, or fire, do not put any containers containing liquid on the unit.
- Do not splash water over the unit and do not touch the unit with wet hands. An electric shock may result.
- Do not spray combustible gas close to the unit. Fire may result.
- Do not place a gas heater or any other open-flame appliance where it will be exposed to the air discharged from the unit. Incomplete combustion may result.
- Do not remove the front panel or the fan guard from the outdoor unit when it is running. You could be injured if you touch rotating, hot or high-voltage parts.
- Never insert fingers, sticks etc. into the intakes or outlets, otherwise injury may result, since the fan inside the unit rotates at high speed. Exercise particular care when children are present.
- Do not touch the refrigerant pipes and refrigerant line components with bare hands during and immediately after operation.
 - The refrigerant in the pipes will be very hot or very cold, resulting in frostbite or burns.
- Do not touch the electrical parts with bare hands during and immediately after operation.
 - Doing so may result in burns or electric shock.
- If you detect odd smells, stop using the unit, turn off the power switch and consult your dealer. Otherwise, a breakdown, electric shock or fire may result.
- When you notice exceptionally abnormal noise or vibration, stop operation, turn off the power switch, and contact your dealer.
- Do not over-cool. The most suitable inside temperature is one that is within 5 °C of the outside temperature.
- Do not leave handicapped people or infants sitting or standing in the path of the airflow from the air-conditioner. This could cause health problems.

⚠ Caution:

- Do not use any sharp object to push the buttons, as this may damage the remote controller.

- Do not twist or tug on the remote controller cord as this may damage the remote controller and cause malfunction.
- Never remove the upper case of the remote controller. It is dangerous to remove the upper case of the remote controller and touch the printed circuit boards inside. Doing so can result in fire and failure.
- Never wipe the remote controller with benzene, thinner, chemical rags, etc. Doing so can result in discoloration and failure. To remove heavy stains, soak a cloth in neutral detergent mixed with water, wring it out thoroughly, wipe the stains off, and wipe again with a dry cloth.
- Never block or cover the indoor or outdoor unit's intakes or outlets. Tall items of furniture underneath the indoor unit, or bulky items such as large boxes placed close to the outdoor unit will reduce the unit's efficiency.
- Do not direct the airflow at plants or caged pets.
- Ventilate the room frequently. If the unit is operated continuously in a closed room for a long period of time, the air will become stale.
- To reduce the risk of injury, do not sit, stand, or place objects on the unit.
- Do not operate the unit with the panels and guards removed.
 - Rotating, hot, or high-voltage parts may cause injury, electric shock, or fire.
- Do not turn off the power immediately after stopping operation.
 - Wait for at least five minutes after the unit has stopped before turning off the power.
 - Failure to do so may cause failure of the unit or water leakage, allowing water to enter the room and damage the interior.
- Do not install the unit over things that are vulnerable to water damage from condensation dripping.
- Do not touch fans, heat exchanger fins, or the sharp edges of components with bare hands.
 - Doing so may result in injury.
- To reduce the risk of fire or electric shock due to dust entering the unit, do not use damaged filters or operate the unit without attaching filters.

In case of failure

⚠ Warning:

- Never remodel the air conditioner. Consult your dealer for any repair or service. Improper repair work can result in water leakage, electric shock, fire, etc.
- If the remote controller displays an error indication, the air conditioner does not run, or there is any abnormality, stop operation and contact your dealer. Leaving the unit as it is under such conditions can result in fire or failure.
- If the power breaker is frequently activated, get in touch with your dealer. Leaving it as it is can result in fire or failure.
- If the refrigeration gas blows out or leaks, stop the operation of the air conditioner, thoroughly ventilate the room, and contact your dealer. Leaving the unit as it is can result in accidents due to oxygen deficiency.

When the air conditioner is not to be used for a long time

- If the air conditioner is not to be used for a long time due to a seasonal change, etc., run it for 4 - 5 hours with the air blowing until the inside is completely dry. Failing to do so can result in the growth of unhygienic, unhealthy mold in scattered areas throughout the room.
- When it is not to be used for an extended time, keep the power supply turned OFF. If the power supply is kept on, several watts or several tens of watts will be wasted. Also, the accumulation of dust, etc., can result in fire.
- Keep the power switched ON for more than 12 hours before starting operation. Do not turn the power supply OFF during seasons of heavy use. Doing so can result in failure.

1.3. Disposing of the unit

⚠ Warning:

- When you need to dispose of the unit, consult your dealer. If pipes are removed incorrectly, refrigerant (fluorocarbon gas) may blow out and come into contact with your skin, causing injury. Releasing refrigerant into the atmosphere also damages the environment.

2. Names and functions of various parts

Attachment and detachment of filter

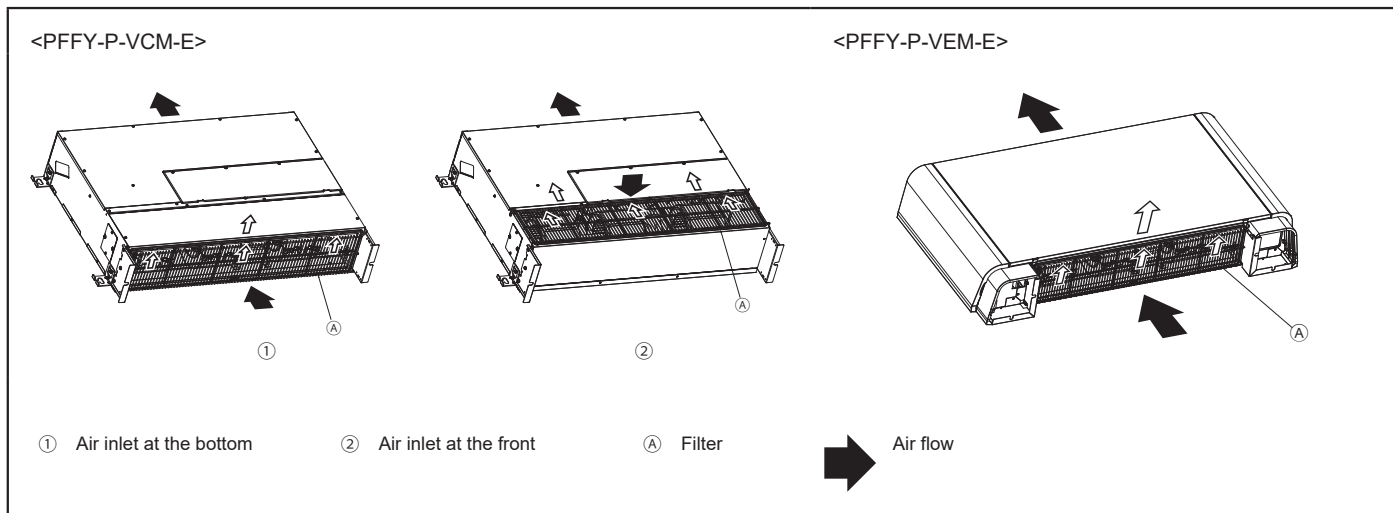

⚠ Caution:

- In removing the filter, precautions must be taken to protect your eyes from dust. Also, if you have to climb up on a stool to do the job, be careful not to fall.
- Turn off the power supply when the filter is changed.
- Make sure the filter is securely fixed in place. If it is loose, debris can enter, resulting in malfunction.

3. How to operate

3.1. Turning ON/OFF

ON

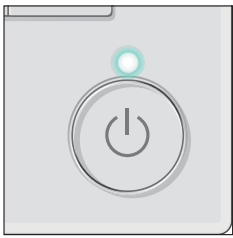

Press the [ON/OFF] button.
The ON/OFF lamp will light up in green, and the operation will start.

* The unit will operate with the previously-set operation mode, set temperature, and fan speed.

OFF



Press the [ON/OFF] button again.
The ON/OFF lamp will come off, and the operation will stop.

3.2. Operation mode

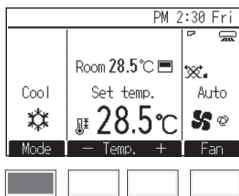

Press the [F1] button to go through the operation modes in the order of "Cool, Dry, Fan, Auto, and Heat."
Select the desired operation mode.

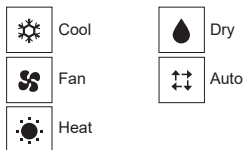

* Operation modes that are not available for the connected indoor unit will not appear on the display.

* Depending on the indoor unit model, either one or two set temperatures (single or dual set point(s)) can be set for Auto mode.

What the blinking mode icon means

The mode icon will blink when other indoor units in the same refrigerant system (connected to the same outdoor unit) are already operated in a different mode. In this case, the rest of the units in the same group can only be operated in the same mode.

Dry mode

- The indoor fan turns to the low-speed operation, disabling the change of fan speed.
- Dry operation cannot be carried out at room temperature of less than 18°C.
- The dry is a microcomputer-controlled dehumidifying operation which controls excessive air-cooling according to the room temperature of your choice. (Not usable for heating.)
 1. Until reaching room temperature of your choice
The compressor and indoor fan function is linked motion according to the change of the room temperature and automatically repeat ON/OFF.
 2. When reaching room temperature of your choice
Both the compressor and indoor fan stop.
When stop continues for 10 minutes, the compressor and indoor fan are operated for 3 minutes to keep the humidity low.

Heat mode

"DEFROST" display

Displayed only during the defrosting operation.

"STAND BY" display

Displayed from the start of heating operation until the moment warm air blows out.

⚠ Caution:

- Never expose your body directly to cool air for a long time. Excessive exposure to cool air is bad for your health, and should therefore be avoided.
- When the air-conditioner is used together with burners, thoroughly ventilate the area. Insufficient ventilation can result in accidents due to oxygen deficiency.
- Never place a burner at a place where it is exposed to the airflow from the air-conditioner. Doing so can result in imperfect combustion of the burner.
- The microcomputer functions in the following cases:
 - Air does not blow out when heating starts.
 - To prevent any cool air from escaping, the indoor fan is gradually switched in sequence from faint airflow/weak airflow/set airflow according to the temperature rise of the blown out air. Wait a moment until the airflow comes out naturally.
 - The fan is not moving at the set speed.
 - In some models, the system switches over to faint airflow when the temperature of the room reaches the set temperature. In other cases, it stops to prevent any cool air from escaping during the defrosting operation.
 - Air flows out even if operation is stopped.
 - Approximately 1 minute after the stop of operation, the indoor fan sometimes rotates to eliminate extra heat generated by the electric heater, etc. The fan speed comes to low or high.

Auto (dual set point) mode

When the operation mode is set to the Auto (dual set point) mode, two set temperatures (one each for cooling and heating) can be set. Depending on the room temperature, indoor unit will automatically operate in either the cooling or heating mode and keep the room temperature within the preset range. The set temperatures that are specified for the Cool/Dry mode and the Heat mode will be used to automatically control the room temperature to stay within the set temperatures. This mode is especially effective during the in-between seasons, when the temperature difference between the highest and the lowest is large and both heating and cooling modes are used within the same day.

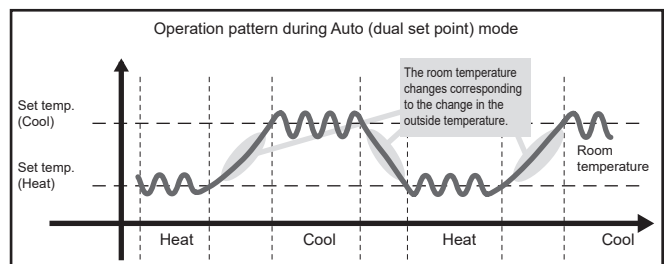

3.3. Set temperature

<Cool, Dry, Heat, and Auto (single set point)>

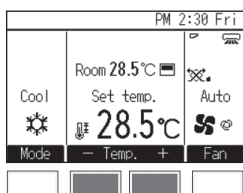

Press the [F2] button to decrease the set temperature, and press the [F3] button to increase.

* Refer to the table below for the settable temperature range for different operation modes.

* Set temperature cannot be set for the Fan mode.

* Depending on the Temperature unit setting, temperatures will decrease or increase by 0.5°C, 1°C, 1°F, or 2°F increments.

<Auto (dual set point) mode>

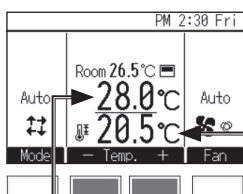

The current set temperatures will appear. Press the [F2] or [F3] button to display the Settings screen.

Set temperature for cooling

Set temperature for heating

Set temperature range

Operation mode	Set temperature range
Cool/Dry	19°C–30°C/67°F–87°F *1
Heat	17°C–28°C/63°F–83°F *1
Auto (single set point)	19°C–28°C/67°F–83°F *1*2
Auto (dual set points)	Cool: Same as the set temperature range for Cool mode Heat: Same as the set temperature range for Heat mode *2*3*4
Fan	Not settable

*1 The settable temperature ranges vary, depending on the indoor unit model.

*2 The set temperature for Auto mode (either single or dual set point(s)) will appear depending on the indoor unit model.

*3 The same values are used for the set temperature for Cool/Dry mode and the cooling set temperature for Auto mode (dual set points). Likewise, the same values are used for the set temperature for Heat mode and the heating set temperature for Auto mode (dual set points).

*4 The cooling and heating set temperatures can be set under the following conditions.
- The cooling set temperature is greater than the heating set temperature.
- The difference between the cooling and heating set temperatures is equal or greater than the minimum temperature difference that varies with the indoor unit model.

3.4. Fan speed

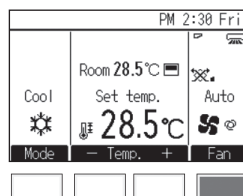

Press the [F4] button to go through the fan speeds in the following order.



• The number of available fan speeds depends on the indoor unit model. [PFFY-P-VCM-E, PFFY-P-VEM-E series]

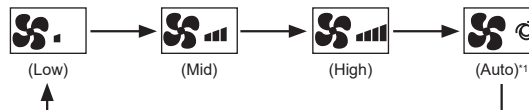

*1 This setting can be adjusted only with MA remote controller.

• The actual fan speed will differ from the fan speed displayed on the LCD when one of the following conditions is met.

1. While "STAND BY" or "DEFROST" is displayed
2. When the room temperature is higher than the set temperature during the heating mode
3. Immediately after the heating operation (during stand by for switching the operation mode)
4. During the Dry mode

4. The smart way to use

Even minimal steps to care for your air conditioner can help make its use far more effective in terms of air-conditioning effect, electricity charges, etc.

Set the right room temperature

- In cooling operation, a temperature difference of about 5°C between indoors and outdoors is optimum.
- If the room temperature is raised by 1°C during air-cooling operation, about 10% electric power can be saved.
- Excessive cooling is bad for health. It also results in the waste of electric power.

Clean the filter thoroughly

- If the screen of the air filter becomes clogged, the airflow and air-conditioning effect can be significantly reduced. Further, if the condition is left unattended, failure can result. It is particularly important to clean the filter at the beginning of the cooling and heating seasons. (When profuse dust and dirt have accumulated, clean the filter thoroughly.)

5. Caring for the machine

Always have filter maintenance performed by a service person. Before care-taking, turn the power supply OFF.

⚠ Caution:

- **Wear protective gear when working on the unit.**
 - Some components carry voltage for several minutes after the main power is turned off, posing electric shock hazards.
- **Wear protective gear before touching any electrical components.**
 - High-voltage parts pose a risk of electric shock, and high-temperature parts pose a risk of burns.
- **Wear protective gloves when working on the unit.**
 - Failure to do so may result in injury.
- **To reduce the risk of injury from falling panels, ensure safety at the work space before installing, inspecting, or repairing the unit.**
- **Before you start cleaning, stop operation and turn OFF the power supply. Remember that the fan is rotating inside at high speed, posing a serious risk of injury.**
- **Indoor units are equipped with filters to remove the dust of sucked-in air. Clean the filters following the procedures below. (The standard filter should normally be cleaned once a week, and the long-life filter at the beginning of each season.)**
- **The life of the filter depends on where the unit is installed and how it is operated.**
- **After disinfecting the unit with chemicals, ventilate the room to disperse the chemical gas before operating the unit.**
 - Exposure to splashes of chemicals may cause injury.
 - Chemicals entering the unit may corrode or deform the unit, causing malfunction.

Prevent intrusion of heat during air-cooling

- To prevent the intrusion of heat during cooling operation, provide a curtain or a blind on the window to block out direct sunlight. Also, do not open the entrance or exit except in cases of dire necessity.

Carry out ventilation sometimes

- Since the air periodically gets dirty in a room that is kept closed for a long time, ventilation is sometimes necessary. When gas appliances are used together with the air conditioner, special precautions must be taken. If the "LOSSNAY" ventilation unit developed by our company is used, you can perform ventilation with less waste. For details on this unit, consult with your dealer.

5.1. Cleaning the indoor units and remote controllers

- Wipe with a dry soft cloth.
- Do not pull on or twist the remote controller cable.
Do not remove the casing from the remote controller.
- To remove finger marks and oil, wipe with a cloth soaked in mild detergent, and wipe off the detergent.
- Do not use gasoline, benzene, thinner, polishing powder, or acid/alkaline solution to clean the indoor units and the controller, for they will damage the controller.

5.2. Cleaning the filter

- Clear dust away lightly or clean it up with a vacuum cleaner. In the case of severe staining, wash the filter in lukewarm water mixed with dissolved neutral detergent or water, and then rinse off the detergent completely. After washing, dry it and fix it back into place.

⚠ Caution:

- **Do not dry the filter by exposing it to direct sunlight or warming it using fire, etc. Doing so can result in the deformation of the filter.**
- **Washing it in hot water (more than 50°C) can also result in deformation.**
- **Never pour water or flammable sprays onto the air conditioner. Cleaning using these methods can result in the failure of the air conditioner, electric shock, or fire.**

6. Troubleshooting

When an error occurs, the following screen will appear and the operation LED will blink. Check the error status, stop the operation, and consult your dealer.

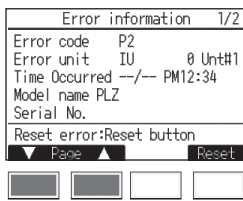

Error code, error unit, refrigerant address, unit model name, and serial number will appear. The model name and serial number will appear only if the information have been registered.

Press the [F1] or [F2] button to go to the next page.

Before you ask for repair service, check the following points:

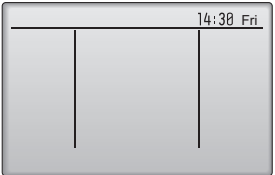
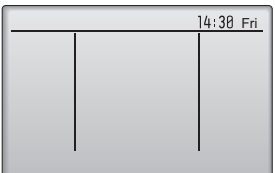
State of Machine	Remote Controller	Cause	Troubleshooting
It does not run.	Ruled line and clock are not displayed. No display appears even when the [ON/OFF] button is pressed.	Power failure	Press the [ON/OFF] button after power restoration.
		The power supply is turned OFF.	Turn the power supply ON.
		The fuse in the power supply is gone.	Replace fuse.
		The earth leakage breaker is gone.	Put in the earth leakage breaker.
Air flows out but it does not cool enough or heat enough.	The liquid crystal display shows that it is in the state of operation.	Improper temperature adjustment	After checking the set temperature and inlet temperature on the liquid crystal display, refer to section 3.3 "Set temperature", and operate the adjustment button.
		The filter is filled with dust and dirt.	Clean up the filter. (Refer to section 5 "Caring for the machine".)
		There are some obstacles at the air inlet and outlet of the indoor and outdoor units.	Remove.
		Windows and doors are open.	Close.
Cool air or warm air does not come out.	The liquid crystal display shows that it is in operation.	The restart-preventing circuit is in operation for 3 minutes.	Wait for a while. (To protect the compressor, a 3-minute restart-preventing circuit is built into the indoor unit. Therefore, there are occasions sometimes when the compressor does not start running immediately. There are cases when it does not run for as long as 3 minutes.)
		Indoor unit operation was restarted during the heating and defrosting operation.	Wait for a while. (Heating operation starts after ending defrosting operation.)
It runs briefly, but soon stops.	The "CHECK" and check code flash on the liquid crystal display.	There are some obstacles at the air inlet and outlet of the indoor and outdoor units.	Rerun after removal
		The filter is filled with dust and dirt.	Rerun after cleaning the filter. (Refer to section 5 "Caring for the machine".)
The sound of the exhaust and rotation of the motor can still be heard after stop of running.	All lights are out except the ruled line and clock. 	When other indoor units are engaged in cooling operation, the machine stops after running a drain-up mechanism for 3 minutes when air-cooling operation is stopped.	Wait for 3 minutes.
The sound of the exhaust and the rotation of the motor can be heard intermittently after stop of running.	All lights are out except the ruled line and clock. 	When other indoor units are engaged in cooling operation, drained water is brought in. If the drain water is collected, the drain-up mechanism initiates a draining operation.	It soon stops. (If the noise occurs more than 2-3 times in an hour, ask for repair service.)
Warm air comes out intermittently when the thermostat is OFF or during fan operation.	The liquid crystal display shows that it is in the state of operation.	When other indoor units are engaged in heating operation, the control valves are opened and closed from time to time to maintain the stability of the system.	It soon stops. (If the room temperature rises uncomfortably high in a small room, stop operation.)

- If operation stops due to a power failure, the [restart-preventing circuit at power failure] operates and disables unit operation even after power restoration. In this case, press the [ON/OFF] button again and start operation.

If malfunctions persist after you have checked the above, turn the power supply OFF and contact your dealer with information about the product name, the nature of the malfunction, etc. If the display of error information flashes, tell the dealer contents of the display (error code). Never attempt to repair by yourself.

The following symptoms are not air conditioner failures:

- The air blown out from the air conditioner can sometimes give off odors. This is due to cigarette smoke contained in the air of the room, the smell of cosmetics, the walls, furniture, etc., absorbed in the air conditioner.
- A hissing noise can be heard immediately after the air conditioner is started or stopped. This is the sound of the refrigeration flowing inside the air conditioner. This is normal.
- The air conditioner sometimes snaps or clicks at the beginning or end of cooling/heating operation. This is the sound of friction on the front panel and other sections due to expansion and contraction caused by temperature change. This is normal.
- The fan speed changes in spite of not changing the setting. Not to blow out cold air at the beginning of heating operation, the air conditioner automatically adjusts the fan speed gradually from lower to the set speed. It also adjust its fan speed to protect the fan motor when return air temperature or fan speed excessively rises.

7. Installation, transferring works, and checking

Regarding place for installation

Consult with your dealer for details on installation and transferring the installation.

⚠ Caution:

- **Never install the air conditioner where there is a risk of leakage of flammable gas. If gas leaks and accumulates around the unit, fire can result.**
- **Never install the air conditioner at the following place:**
 - where there is a lot of machine oil
 - near the ocean and beach areas where there is salt air.
 - where humidity is high
 - where there are hot springs nearby
 - where there is sulphurous gas
 - where there is a high-frequency processing machinery (a high-frequency welder, etc.)
 - where acid solution is frequently used
 - where special sprays are frequently used.
- **Install the indoor unit horizontally. Otherwise, water leakage can result.**
- **Take sufficient measures against noise when installing the air conditioners at hospitals or communication-related businesses.**

If the air conditioner is used in any of the above-mentioned environments, frequent operational failure can be expected. It is advisable to avoid these types of installation sites.

For further details, consult with your dealer.

Regarding electrical work

⚠ Caution:

- **The electrical work must be undertaken by a person who is qualified as an electrical engineer according to the [technical standard respecting electrical installation], [internal wiring rules], and the installation instruction manual with the absolute use of exclusive circuits. The use of other products with the power source can result in burnt-out breakers and fuses.**
- **Never connect the grounding wire to a gas pipe, water pipe, arrester, or telephone grounding wire. For details, consult with your dealer.**
- **In some types of installation sites, the installation of an earth leakage breaker is mandatory. For details, consult with your dealer.**

Regarding transfer of installation

- When removing and reinstalling the air conditioner when you enlarge your home, remodel, or move, consult with your dealer in advance to ascertain the cost of the professional engineering work required for transferring the installation.

⚠ Caution:

- **When moving or reinstalling the air conditioner, consult with your dealer. Defective installation can result in electric shock, fire, etc.**

Regarding noise

- In installing work, choose a place that can fully bear the weight of the air conditioner, and where noise and vibration can be reduced.
- Choose a place where cool or warm air and noise from the outdoor air outlet of the air conditioner does not inconvenience the neighbors.
- If any alien object is placed near the outdoor air outlet of the air conditioner, decreased performance and increased noise can result. Avoid placing any obstacles adjacent to the air outlet.
- If the air conditioner produces any abnormal sound, consult with your dealer.

Maintenance and inspection

- If the air conditioner is used throughout several seasons, the insides can get dirty, reducing the performance. Depending upon the conditions of usage, foul odors can be generated and drainage can deteriorate due to dust and dirt, etc.

8. Specifications

PPFY-P-VCM-E series

		P20VCM-E	P25VCM-E	P32VCM-E	P40VCM-E	
Power source		~220-240 V 50/60 Hz				
Cooling capacity ^{*1} /Heating capacity ^{*1}	kW	2.2/2.5	2.8/3.2	3.6/4.0	4.5/5.0	
Dimension (Height/Width/Depth)	mm	615/700/200	615/700/200	615/700/200	615/900/200	
Net weight	kg	18	18	18.5	22.5	
Fan	Airflow rate (Low-Middle-High)	m ³ /min	5.0-6.0-7.0	5.5-6.5-8.0	5.5-7.0-8.5	8.0-9.5-11.0
	External static pressure ^{*2}	Pa	0/10/40/60	0/10/40/60	0/10/40/60	0/10/40/60
Sound pressure level ^{*3} (Low-Middle-High)	dB(A)	21-23-26	22-25-29	23-26-30	25-28-30	
Filter	Standard filter					

		P50VCM-E	P63VCM-E	
Power source		~220-240 V 50/60 Hz		
Cooling capacity ^{*1} /Heating capacity ^{*1}	kW	5.6/6.3	7.1/8.0	
Dimension (Height/Width/Depth)	mm	615/900/200	615/1100/200	
Net weight	kg	22.5	25.5	
Fan	Airflow rate (Low-Middle-High)	m ³ /min	10.0-11.5-13.5	12.0-14.0-16.5
	External static pressure ^{*2}	Pa	0/10/40/60	0/10/40/60
Sound pressure level ^{*3} (Low-Middle-High)	dB(A)	28-31-34	28-32-35	
Filter	Standard filter			

* Operation temperature of indoor unit
Cooling mode: 15°C WB - 24°C WB
Heating mode: 15°C DB - 27°C DB

*1 Cooling/Heating capacity indicates the maximum value at operation under the following condition.
<Cooling> Indoor: 27°C DB/19°C WB, Outdoor: 35°C DB
<Heating> Indoor: 20°C DB, Outdoor: 7°C DB/6°C WB

*2 The external static pressure is set to 10 Pa at factory shipment.

*3 The operating noise is the data that was obtained in an anechoic room.

PPFY-P-VEM-E series

		P20VEM-E	P25VEM-E	P32VEM-E	P40VEM-E
Power source		~220-240 V 50/60 Hz			
Cooling capacity ^{*1} /Heating capacity ^{*1}	kW	2.2/2.5	2.8/3.2	3.6/4.0	4.5/5.0
Dimension (Height/Width/Depth) ^{*2}	mm	669(726)/1142/217	669(726)/1142/217	669(726)/1142/217	669(726)/1342/217
Net weight	kg	29.5	29.5	30	35
Fan airflow rate (Low-Middle-High)	m ³ /min	5.0-6.0-7.0	5.5-6.5-8.0	5.5-7.0-8.5	8.0-9.5-11.0
Sound pressure level ^{*3} (Low-Middle-High)	dB(A)	23-27-31	25-29-34	25-31-36	29-33-36
Filter	Standard filter				

		P50VEM-E	P63VEM-E
Power source		~220-240 V 50/60 Hz	
Cooling capacity ^{*1} /Heating capacity ^{*1}	kW	5.6/6.3	7.1/8.0
Dimension (Height/Width/Depth) ^{*2}	mm	669(726)/1342/217	669(726)/1542/217
Net weight	kg	35	39.5
Fan airflow rate (Low-Middle-High)	m ³ /min	10.0-11.5-13.5	12.0-14.0-16.5
Sound pressure level ^{*3} (Low-Middle-High)	dB(A)	34-37-41	32-36-40
Filter	Standard filter		

* Operation temperature of indoor unit.
Cooling mode: 15°C WB - 24°C WB
Heating mode: 15°C DB - 27°C DB

*1 Cooling/Heating capacity indicates the maximum value at operation under the following condition.
<Cooling> Indoor: 27°C DB/19°C WB Outdoor: 35°C DB
<Heating> Indoor: 20°C DB Outdoor: 7°C DB/6°C WB

*2 The values in () show the height of unit with leg.

*3 The operating noise is the data that was obtained in an anechoic room.

Product Information

A Model	B Cooling Capacity (kW)		E Heating Capacity (kW)	F Total electric power input (kW) P _{elec}	G Sound power level (per speed setting, if applicable) (dBA) L _{WA}			
	C Sensible P _{rated,c}	D Latent P _{rated,c}	P _{rated,h}					
PFFY-P20VCM-E	1.70	0.50	2.50	0.022	46	44	43	-
PFFY-P25VCM-E	1.90	0.90	3.20	0.026	49	46	44	-
PFFY-P32VCM-E	2.40	1.20	4.00	0.031	50	48	46	-
PFFY-P40VCM-E	3.30	1.20	5.00	0.038	50	48	47	-
PFFY-P50VCM-E	4.00	1.60	6.30	0.053	54	51	50	-
PFFY-P63VCM-E	5.00	2.10	8.00	0.058	55	53	52	-
PFFY-P20VEM-E	1.70	0.50	2.50	0.021	51	47	43	-
PFFY-P25VEM-E	1.90	0.90	3.20	0.026	54	49	45	-
PFFY-P32VEM-E	2.40	1.20	4.00	0.031	56	51	45	-
PFFY-P40VEM-E	3.30	1.20	5.00	0.037	56	53	49	-
PFFY-P50VEM-E	4.00	1.60	6.30	0.053	61	57	54	-
PFFY-P63VEM-E	5.00	2.10	8.00	0.061	60	56	52	-

Note: _____

Rating condition

Cooling - Indoor: 27°C DB, 19°C WB
 Outdoor: 35°C DB, 24°C WB
 Heating - Indoor: 20°C DB, 15°C WB
 Outdoor: 7°C DB, 6°C WB

Recycle

Your MITSUBISHI ELECTRIC product is designed and manufactured with high quality materials and components which can be recycled and reused. Electrical and electronic equipment, at their end-of-life, should be disposed of separately from your household waste. Please, dispose of this equipment at your local community waste collection/ recycling center. In the European Union there are separate collection systems for used electrical and electronic product. Please, help us to conserve the environment we live in!

	Deutsch	Български	Eesti
	Français	Polski	Latviski
	Nederlands	Malti	Lietuviškai
	Español	Suomi	Hrvatski
	Italiano	Čeština	Norsk
	Ελληνικά	Slovenčina	Türkçe
	Português	Magyar	русский
	Dansk	Slovenščina	
	Svenska	Română	
A	Modell	Модел	Mudel
	modèle	Model	Modelis
	model	Mudell	Modelis
	modelo	Malli	Model
	modello	Model	Modell
	Μοντέλο	Model	Model
	Modelo	Modell	Модель
	Model	Model	
	Modell	Model	
B	Kühlleistung	Охладителна мощност	Jahutusvõimsus
	Puissance frigorifique	Wydajność chłodnicza	Dzesēšanas jauda
	Koelvermogen	Kapacitá tat-ikessiñ	Vésinimo pajégumas
	Potencia de refrigeración	Jäähdytysteho	Kapacitet hlādenja
	Capacità di raffreddamento	Chladicí výkon	Kjōlekapasitet
	Ψυκτική ισχύς	Výkon chlādenia	Sočutma Kapasitesi
	Potência de arrefecimento	Hűtőteljesítmény	Охлаждающая мощность
	Køleydelse	Zmogljivost hlajenja	
Kylkapacitet	Capacitatea de răcire		
C	sensibel	за осезаема топлина	tajutav
	sensible	jawna	jūtāmā
	waarneembaar	sensitiva	juntamojo
	sensible	tuntuva	osjetni
	sensibile	citelný	Fornuftig
	αισθητή	citelný	Duyulur
	razoável	érezhető	Явная
	sensibel	občutljivo	
kännbar	sensibilă		
D	latent	за скрита топлина	latentne
	latente	utajona	latentā
	latent	latenti	slaptojo
	latente	latenti	latentni
	latente	latentní	Latent
	Λανθάνουσα	latentný	Gizli
	latente	latens	Скрытая
	latent	latentno	
latent	Capacitate de încălzire		
E	Wärmeleistung	Отопительна мощност	Küttevõimsus
	Puissance calorifique	Wydajność grzewcza	Sildšanas jauda
	Verwarmingsvermogen	Kapacitá tat-tishin	Šildymo pajégumas
	Potencia de calefacción	Lāmmitysteho	Kapacitet grijanja
	Capacità di riscaldamento	Topný výkon	Varmekapasitet
	Θερμαντική ισχύς	Vykurovací výkon	Isitma Kapasitesi
	Potência de aquecimento	Fűtőteljesítmény	Отопительная мощность
	Varmeydelse	Zmogljivost ogrevanja	
Uppvärmningskapacitet	Capacitate de încălzire		

F	Elektrische Gesamtleistungsaufnahme	Общо консумирана електрическа мощност	Koguelektritarbimine
	Puissance électrique absorbée totale	Saġkowity pobór mocy elektrycznej	Korpeġa elektriskā ieejas jauda
	Totaal elektrisch ingangsvermogen	Total tal-input tal-enerġija elettrika	Bendra elektrinė vartojamoji galia
	Potencia eléctrica total utilizada	Sähkõn kokonaisototeho	Ukupan utrošak električne energije
	Potenza elettrica assorbita totale	Celkový elektrický příkon	Total elektrisk strøminngang
	Συνολική ηλεκτρική ισχύς εισόδου	Celkový elektrický příkon	Toplam elektrik gücü girişi
	Potência elétrica de entrada total	Teljes villamosenergia-bevitel	Суммарная подводимая электрическая мощность
	Samlet elektrisk effektoptag	Skupna vhodna električna moč	
	Total tillförd elektrisk effekt	Putere electrică de intrare totală	
	G	Schalleistungspegel (ggf. je Geschwindigkeitseinstellung)	Ниво на звуковата мощност (за отделните настройки на оборотите, ако е приложимо)
Niveau de puissance acoustique (pour chaque réglage de la vitesse, si disponible)		Poziom mocy akustycznej (w stosownych przypadkach w zależności od ustawienia prędkości)	Akustiskās jaudas līmenis (attiecīgā gadījumā – katram ātruma iestatījumam)
Geluidsvermogensniveau (per snelheid, indien van toepassing)		Livell ta' qawwa tal-ħoss (għal kull veloċità, jekk ikun applikabbli)	Garso galios lygis (kiekvieno spartos nuostačio, jei taikoma)
Nivel de potencia acústica (por velocidad regulada, si procede)		Äänitehaso (tarvittaessa käyntinopeuksittain)	Razina zvučne snage (u svakoj postavki brzine, ako je primjenjivo)
Livello di potenza sonora (per ogni impostazione di velocità, se pertinente)		Hladina akustického výkonu (v příslušných případech pro jednotlivá nastavení rychlosti)	Lydeffektivā (per hastighetsinnstilling, hvis aktuelt)
Στάθμη ηχητικής ισχύος (ανά ρυθμιζόμενη ταχύτητα, κατά περίπτωση)		Hladina akustického výkonu (v prípade potreby z hladiska nastavenia rýchlosti)	Ses gücü seviyesi (geçerli durumlarda hız ayarına göre)
Nível de potência sonora (por regulação da velocidade, se for caso disso)		Hangteljesítményszint (fordulatszám-beállításonként, ha alkalmazandó)	Уровень звуковой мощности (по настройке скорости, если применимо)
Lydeffektniveau (pr. hastighedsindstilling, hvis relevant)		Nivo zvokovne moči (na nastavljenosti hitrost, če je ustrezno)	
Ljudeffektivā (per hastighet, om tillämpligt)		Nivelul de putere acustică (per treaptă de viteză, dacă este cazul)	

EC DECLARATION OF CONFORMITY
EG-KONFORMITÄTSEKTLÄRUNG
DECLARATION DE CONFORMITÉ CE
EG-CONFORMITEITSVERKLARING
DECLARACIÓN DE CONFORMIDAD CE
DICHIARAZIONE DI CONFORMITÀ CE

ΔΗΛΩΣΗ ΠΙΣΤΟΤΗΤΑΣ EK
DECLARAÇÃO DE CONFORMIDADE CE
EG-DEKLARATION OM ÖVERENSSTÄMMELSE
EC UYGUNLUK BEYANI
ДЕКЛАРАЦИЯ СООТВЕТСТВИЯ НОРМАМ ЕС
PROHLÁŠENÍ O SHODĚ EU

VYHLÁŠENIE O ZHODE S NORMAMI ES
IZJAVA ES O SKLADNOSTI
EK MEGFELELŐSÉGI NYILATKOZAT
DEKLARACJA ZGODNOŚCI WE
EC IZJAVA O SUKLADNOSTI
ЕС ДЕКЛАРАЦИЯ ЗА СЪОТВЕТСТВИЕ

DECLARAȚIE DE CONFORMITATE CE
EF-OVERENSSTEMMELSESERKLÆRING
EF-SAMSVARSERKLÆRING

MITSUBISHI ELECTRIC CONSUMER PRODUCTS (THAILAND) CO., LTD.
700/406 MOO 7, TAMBON DON HUA ROH, AMPHUR MUANG, CHONBURI 20000, THAILAND
MADE IN THAILAND

hereby declares under its sole responsibility that the air conditioners and heat pumps described below for use in residential, commercial and light-industrial environments:
erklärt hiermit auf seine alleinige Verantwortung, dass die Klimaanlage und Wärmepumpen für das häusliche, kommerzielle und leicht-industrielle Umfeld wie unten beschrieben:
déclare par la présente et sous sa propre responsabilité que les climatiseurs et les pompes à chaleur décrits ci-dessous, destinés à un usage dans des environnements résidentiels, commerciaux et d'industrie légère :
verklaart hierbij onder eigen verantwoordelijkheid dat de voor residentiële, commerciële en licht-industriële omgevingen bestemde airconditioners en warmtepompen zoals onderstaand beschreven:
por la presente declara bajo su única responsabilidad que los acondicionadores de aire y bombas de calor descritas a continuación para su uso en entornos residenciales, comerciales y de industria ligera.
conferma con la presente, sotto la sua esclusiva responsabilità, che i condizionatori d'aria e le pompe di calore descritti di seguito e destinati all'utilizzo in ambienti residenziali, commerciali e semi-industriali:
με το παρόν πιστοποιώ με αποκλειστική της ευθύνη ότι οι τα κλιματιστικά και οι αντλίες θέρμανσης που περιγράφονται παρακάτω για χρήση σε οικιακό, επαγγελματικό και ελαφράς βιομηχανίας περιβάλλοντα:
através da presente declara sob sua única responsabilidade que os aparelhos de ar condicionado e bombas de calor abaixo descritos para uso residencial, comercial e de indústria ligeira:
intyar härmed att luftkonditioneringarna och värmepumparna som beskrivs nedan för användning i bostäder, kommersiella miljöer och lätta industriella miljöer:
ev, üicaret ve hafif sanayi ortamlarında kullanım amaçlı üretilen ve aşağıda açıklanan klima ve ısıtma pompalarıyla ilgili aşağıdaki hususları yalnızca kendi sorumluluğunda beyan eder:
настоящим заявляет и берет на себя исключительную ответственность за то, что кондиционеры и тепловые насосы, описанные ниже и предназначенные для эксплуатации в жилых помещениях, торговых залах и на предприятиях легкой промышленности:
tímto prohlašuje na svou výhradní odpovědnost, že klimatizační jednotky a tepelná čerpadla popsaná níže jsou určena pro provoz v obytných prostorách, obchodních prostorách a prostorách lehkého průmyslu:
týmto na vlastnú zodpovednosť vyhlasuje, že klimatizácie a tepelné čerpadlá uvedené nižšie, ktoré sú určené na použitie v domácnostiach, oblasti obchodu a ľahkého priemyslu:
izjavlja, v skladu z izključno odgovornostjo, da so klimatske naprave in toplotne črpalke, opisane spodaj, za uporabo v stanovanjskih, gospodarskih in manjših industrijskih okoljih:
kizárólagos felelőssége tudatában kijelenti, hogy az alábbiakban leírt – lakossági, kereskedelmi és könnyűipari használatra szánt – légkondicionálók és hőszivattyúk:
niniejsum oświadczamy, że klimatyzatory i pompy ciepłe opisane niżej do użytkowania w środowisku mieszkaniowym, komercyjnym lub przemysłowym lekkim:
pod punom odgovornostju izjavljuje da klima-uređaji i toplinske pumpe opisani u nastavku, namijenjeni za korištenje u stambenim i poslovnim prostorima i pogonima lake industrije:
с настоящим декларира на своя собствена отговорност, че климатизаторите и термопомпите, са описани по-долу и предназначени за експлоатация в жилищни помещения, търговски халета и предприятия от леката промишленост:
prin prezenta declară pe proprie răspundere că aparatele de aer condiționat și pompele de căldură descrise mai jos pentru utilizare în medii rezidențiale, comerciale și industriale ușoare:
erklærer hermed med eneansvar, at klimaanlæggene og varmepumperne beskrevet nedenfor til brug i beboelsesmiljøer, kommercielle miljøer og lettindustriilmiljøer:
erklærer herved på eget ansvar at klimaanleggene og varmepumperne beskrevet nedenfor for bruk i bolig-, kommersielle og lettindustrielle miljøer:

MITSUBISHI ELECTRIC, PFFY-P20VCM-E*, PFFY-P25VCM-E*, PFFY-P32VCM-E*, PFFY-P40VCM-E*, PFFY-P50VCM-E*, PFFY-P63VCM-E*
PFFY-P20VEM-E*, PFFY-P25VEM-E*, PFFY-P32VEM-E*, PFFY-P40VEM-E*, PFFY-P50VEM-E*, PFFY-P63VEM-E*
* : , , 1, 2, 3, ··· , 9

Note: Its serial number is on the nameplate of the product.
Hinweis: Die Seriennummer befindet sich auf dem Kennschild des Produkts.
Remarque : Le numéro de série de l'appareil se trouve sur la plaque du produit.
Opmerking: het serienummer staat op het naamplaatje van het product.
Nota: El número de serie se encuentra en la placa que contiene el nombre del producto.
Nota: Il numero di serie si trova sulla targhetta del prodotto.
Σημείωση: Ο σειριακός του αριθμός βρίσκεται στην πινακίδα ονόματος του προϊόντος.
Nota: o número de série encontra-se na placa que contém o nome do produto.
Obs: Serienumret finns på produktens namnplåt.
Not: Seri numarasi ürünün isim plakasında yer alır.
Примечание: серийный номер указан на паспортное табличке изделия.

Poznámka: Sériové číslo je na typovém štítku výrobku.
Poznámka: Sériové číslo sa nachádza na továrenskcom štítku produktu.
Opomba: Serijska številka je na tablici z imenom izdelka.
Megjegyzés: A sorozatszám a termék adattábláján található.
Uwaga: Numer seryjny znajduje się na tabliczce znamionowej produktu.
Napomena: Serijski broj je naznačen na natpisnoj pločici proizvoda.
Забелешка: Серијният номер се намира на табелката с данни на продукта.
Notă: Numărul de serie este amplasat pe plăcuța produsului.
Bemærk: Serienumret befinder sig på produktets typeskilt.
Merk: Serienummeret finner du på produktets typeskilt.

Directives
Richtlijnen
Directives
Richtlijnen
Directivas
Direttive
Οδηγίες
Directivas
Direktiv
Direktiver
Директивы
Směrnice
Smernice
Direktive
Irányelvek
Dyrektywy
Direktive
Директиви
Directive
Direktiver
Direktiver

2014/35/EU: Low Voltage
2006/42/EC: Machinery
2014/30/EU: Electromagnetic Compatibility
2011/65/EU: Restriction of Hazardous Substances
2009/125/EC: Energy-related Products (with Regulation No. 206/2012)

<ENGLISH>

English is original. The other languages versions are translation of the original.

⚠ CAUTION

- Refrigerant leakage may cause suffocation. Provide ventilation in accordance with EN378-1.
- Be sure to wrap insulation around the piping. Direct contact with the bare piping may result in burns or frostbite.
- Never put batteries in your mouth for any reason to avoid accidental ingestion.
- Battery ingestion may cause choking and/or poisoning.
- Install the unit on a rigid structure to prevent excessive operation sound or vibration.
- Noise measurement is carried out in accordance with JIS C9612, JIS B8616, ISO 5151(T1), and ISO 13523(T1).

<DEUTSCH>

Das Original ist in Englisch. Die anderen Sprachversionen sind vom Original übersetzt.

⚠ VORSICHT

- Das Auslaufen von Kältemittel kann zu Erstickung führen. Sorgen Sie für Belüftung gemäß der Bestimmung EN378-1.
- Sicherstellen, dass die Rohrführung isoliert ist. Direkter Kontakt mit der blanken Rohrführung kann zu Verbrennungen oder Erfrierung führen.
- Nehmen Sie unter keinen Umständen Batterien in den Mund, um versehentliches Verschlucken zu vermeiden.
- Das Verschlucken von Batterien kann zu Erstickung und/oder Vergiftung führen.
- Installieren Sie das Gerät an einer stabilen Struktur, um übermäßige Betriebsgeräusche oder Vibration zu vermeiden.
- Geräuschmessungen werden gemäß der Bestimmungen JIS C9612, JIS B8616, ISO 5151(T1), und ISO 13523(T1) ausgeführt.

<FRANÇAIS>

L'anglais est l'original. Les versions fournies dans d'autres langues sont des traductions de l'original.

⚠ PRECAUTION

- Une fuite de réfrigérant peut entraîner une asphyxie. Fournissez une ventilation adéquate en accord avec la norme EN378-1.
- Assurez-vous que la tuyauterie est enveloppée d'isolant. Un contact direct avec la tuyauterie nue peut entraîner des brûlures ou des engelures.
- Ne mettez jamais des piles dans la bouche pour quelque raison que ce soit pour éviter de les avaler par accident.
- Le fait d'ingérer des piles peut entraîner un étouffement et/ou un empoisonnement.
- Installez l'unité sur une structure rigide pour prévenir un bruit de fonctionnement et une vibration excessifs.
- Les mesures de niveau sonore ont été effectuées en accord avec les normes JIS C9612, JIS B8616, ISO 5151(T1) et ISO 13523(T1).

<NEDERLANDS>

Het Engels is het origineel. De andere taalversies zijn vertalingen van het origineel.

⚠ VOORZICHTIG

- Het lekken van koelvloeistof kan verstikking veroorzaken. Zorg voor ventilatie in overeenstemming met EN378-1.
- isoleer de leidingen met isolatiemateriaal. Direct contact met de onbedekte leidingen kan leiden tot brandwonden of bevriezing.
- Stop nooit batterijen in uw mond om inslikking te voorkomen.
- Het inslikken van batterijen kan verstikking of vergiftiging veroorzaken.
- Installeer het apparaat op een stabiele structuur om overmatig lawaai of trillingen te voorkomen.
- Geluidsmetingen worden uitgevoerd in overeenstemming met JIS C9612, JIS B8616, ISO 5151(T1), en ISO 13523(T1).

<ESPAÑOL>

El idioma original del documento es el inglés. Las versiones en los demás idiomas son traducciones del original.

⚠ CUIDADO

- Las pérdidas de refrigerante pueden causar asfixia. Se debe proporcionar la ventilación determinada en EN378-1.
- Asegúrese de colocar el aislante alrededor de las tuberías. El contacto directo con la tubería puede ocasionar quemaduras o congelación.
- Para evitar una ingestión accidental, no coloque las pilas en su boca bajo ningún concepto.
- La ingestión de las pilas puede causar asfixia y/o envenenamiento.
- Coloque la unidad en una estructura rígida para evitar que se produzcan sonidos o vibraciones excesivos debidos a su funcionamiento.
- La medición de los ruidos se lleva a cabo de acuerdo con JIS C9612, JIS B8616, ISO 5151(T1) y ISO 13523(T1).

<ITALIANO>

Il testo originale è redatto in lingua Inglese. Le altre versioni linguistiche rappresentano traduzioni dell'originale.

⚠ ATTENZIONE

- Perdite di refrigerante possono causare asfissia. Prevedere un ventilazione adeguata in conformità alla norma EN378-1.
- Accertarsi di applicare materiale isolante intorno alle tubature. Il contatto diretto con le tubature non schermate può provocare ustioni o congelamento.
- Non introdurre in nessun caso le batterie nella bocca onde evitare ingestioni accidentali.
- L'ingestione delle batterie può provocare soffocamento e/o avvelenamento.
- Installare l'unità su di una struttura rigida in modo da evitare rumore o vibrazioni eccessivi durante il funzionamento.
- La misurazione del rumore viene effettuata in conformità agli standard JIS C9612, JIS B8616, ISO 5151(T1) e ISO 13523(T1).

<ΕΛΛΗΝΙΚΑ>

Η γλώσσα του πρωτοτύπου είναι η αγγλική. Οι εκδόσεις άλλων γλωσσών είναι μεταφράσεις του πρωτοτύπου.

⚠ ΠΡΟΣΟΧΗ

- Η διαρροή του ψυκτικού ενδέχεται να προκαλέσει ασφυξία. Φροντίστε για τον εξαερισμό σύμφωνα με το EN378-1.
- Βεβαιωθείτε ότι τυλίξατε με μονωτικό υλικό τη σωλήνωση. Η απευθείας επαφή με τη γυμνή σωλήνωση ενδέχεται να προκαλέσει εγκαύματα ή κρυοπαγήματα.
- Μην βάζετε ποτέ τις μπαταρίες στο στόμα σας για κανένα λόγο ώστε να αποφύγετε την κατά λάθος κατάποσή τους.
- Η κατάποση μπαταριών ενδέχεται να προκαλέσει πνιγμό και/ή δηλητηρίαση.
- Εγκαταστήστε τη μονάδα σε σταθερή κατασκευή ώστε να αποφεύγετε τον έντονο ήχο λειτουργίας ή τους κραδασμούς.
- Η μέτρηση θορύβου πραγματοποιήθηκε σύμφωνα με τα JIS C9612, JIS B8616, ISO 5151(T1) και ISO 13523(T1).

<PORTUGUÊS>

O idioma original é o inglês. As versões em outros idiomas são traduções do idioma original.

⚠ CUIDADO

- As fugas de refrigerante podem provocar asfixia. Proporcione ventilação de acordo com a EN378-1.
- Certifique-se de que coloca isolamento em redor da tubagem. O contacto directo com a tubagem pode resultar em queimaduras ou úlceras causadas pelo frio.
- Para evitar uma ingestão accidental, nunca coloque pilhas na boca.
- A ingestão das pilhas pode provocar asfixia e/ou envenenamento.
- Instale a unidade numa estrutura rígida para evitar vibrações ou ruídos excessivos durante o seu funcionamento.
- A medição dos ruídos é efectuada de acordo com a JIS C9612, JIS B8616, ISO 5151(T1), e ISO 13523(T1).

<SVENSKA>

Engelska är originalspråket. De övriga språkversionerna är översättningar av originalet.

⚠ FÖRSIKTIGHET

- Köldmedelsläckage kan leda till kvävning. Tillhandahåll ventilation i enlighet med EN378-1.
- Kom ihåg att linda isolering runt rören. Direktkontakt med bara rör kan leda till brännskador eller köldskador.
- Stoppa aldrig batterier i munnen, de kan sväljas av misstag.
- Om ett batteri sväljs kan det leda till kvävning och/eller förgiftning.
- Montera enheten på ett stadigt underlag för att förhindra höga driftljud och vibrationer.
- Ljudmätningar har utförts i enlighet med JIS C9612, JIS B8616, ISO 5151(T1) och ISO 13523(T1).

<TÜRKÇE>

Aslı İngilizce'dir. Diğer dillerdeki sürümler aslının çevirisidir.

⚠ DİKKAT

- Soğutucu sızıntısı boğulma tehlikesine yol açabilir. EN378-1'e göre havalandırma sağlayın.
- Boruların etrafına izolasyon malzemesi kaplamayı unutmayın. Çıplak boruya doğrudan temas etmek yanmaya ve soğuk ısırmasına neden olabilir.
- Yanlışlıkla yutmamak için pilleri hiçbir nedenle asla ağzınıza sokmayın.
- Pili yutmak boğulmaya ve/veya zehirlenmeye neden olabilir.
- Aşırı çalışma sesinin veya titreşimin oluşmaması için üniteyi sert bir yapı üzerine kurun.
- Ses ölçümü JIS C9612, JIS B8616, ISO 5151(T1), ve ISO 13523(T1) standartlarına göre yapılır.

<РУССКИЙ>

Языком оригинала является английский. Версии на других языках являются переводом оригинала.

⚠ ОСТОРОЖНО

- Утечка хладагента может стать причиной удушья. Обеспечьте вентиляцию в соответствии с EN378-1.
- Обязательно оберните трубы изоляционной обмоткой. Непосредственный контакт с неизолированным трубопроводом может привести к ожогам или обморожению.
- Запрещается класть элементы питания в рот по каким бы то ни было причинам во избежание случайного проглатывания.
- Попадание элемента питания в пищеварительную систему может стать причиной удушья и/или отравления.
- Устанавливайте устройство на жесткую структуру во избежание чрезмерного шума или чрезмерной вибрации во время работы.
- Измерение шума выполняется в соответствии с JIS C9612, JIS B8616, ISO 5151(T1) и ISO 13523(T1).

<ČESKY>

Originálem je angličtina. Ostatní jazykové verze jsou překladem originálu.

⚠ UPOZORNĚNÍ

- Únik chladiva může způsobit udušení. Zajistěte větrání v souladu s normou EN378-1.
- Nezapomeňte okolo potrubí umístit izolaci. Přímý styk s holým potrubím může způsobit popáleninám nebo omrzlinám.
- Nikdy nevkládejte baterie z žádného důvodu do úst, abyste je náhodně neposlkali.
- Spolknutí baterie může způsobit udušení nebo otrávení.
- Jednotku namontujte na tuhou konstrukci, abyste zabránili nadměrné provozní hlučnosti nebo vibracím.
- Měření hlučnosti se provádí v souladu s normami JIS C9612, JIS B8616, ISO 5151(T1) a ISO 13523(T1).

<SLOVENČINA>

Pôvodným jazykom je angličtina. Ostatné jazykové verzie vznikli prekladom z pôvodného jazyka.

⚠ UPOZORNENIE

- Presakovanie chladivacej zmesi môže spôsobiť udusenie. Zabezpečte vetranie v súlade s normou EN378-1.
- Okolo potrubia omotajte izoláciu. Priamy kontakt s neizolovalým potrubím môže viesť k popáleninám alebo omrzlinám.
- Zo žiadneho dôvodu si nevkładajte batérie do úst. Mohli by ste ich náhodne prehltnúť.
- Prehltnutie batérií môže vyvolať dusenie alebo otravu.
- Jednotku umiestnite na pevnú konštrukciu, aby ste predišli nadmernému prevádzkovému huku alebo vibráciám.
- Meranie huku sa vykonáva v súlade s normami JIS C9612, JIS B8616, ISO 5151(T1) a ISO 13523(T1).

<SLOVENŠČINA>

Izvirnik je v angleščini. Drugi jezikovne različice so prevodi izvirnika.

⚠ POZOR

- Uhajanje sredstva za hlajenje lahko povzroči zadušitev. Poskrbite za prezračevanje v skladu z EN378-1.
- Cevi ovijte v izolacijo. Neposredni stik z golimi cevmi lahko povzroči opekline ali ozebline.
- Nikoli ne vstavljajte baterij v usta, da s tem preprečite nenamerno zaužitje.
- Zaužitje baterije lahko povzroči dušenje in/ali zastrupitev.
- Enoto namestite na trdno strukturo, da s tem preprečite prekomerni hrup in vibracije med delovanjem.
- Meritve hrupa so izvršene v skladu z JIS C9612, JIS B8616, ISO 5151(T1) in ISO 13523(T1).

<MAGYAR>

Az eredeti szöveg angol nyelven íródott. A más nyelven írt változatok az eredeti szöveg fordításai.

▲ FIGYELMEZTETÉS

- A hűtőközeg szivárgása fulladást okozhat. Gondoskodjon a szellőzésről az EN378-1 szerint.
- Feltétlenül gondoskodjon a csövek szigeteléséről. A fedetlen csövek közvetlen megérintése égési vagy fagyási sérülést okozhat.
- Soha, semmilyen okból ne vegye a szájába az elemeket, nehogy véletlenül lenyelje.
- Az elem lenyelése fulladást és/vagy mérgezést okozhat.
- Az üzem közben fellépő, túlzott mértékű zaj és rezgés elkerülése érdekében az egységet merev szerkezetre kell szerelni.
- A zaj mérése a JIS C9612, JIS B8616, ISO 5151(T1) és ISO 13523(T1) szerint történik.

<POLSKI>

Oryginał jest w języku angielskim. Pozostałe wersje językowe stanowią tłumaczenia oryginału.

▲ PRZESTROGA

- Wyciek czynnika chłodniczego może spowodować uduszenie. Należy zapewnić wentylację zgodnie z normą EN378-1.
- Należy pamiętać o owinięciu instalacji rurą materiałem izolacyjnym. Bezpośredni kontakt z nieosłoniętą instalacją może spowodować oparzenia lub odmrożenia.
- Nigdy pod żadnym pozorem nie wkładaj baterii do ust, mogłoby to spowodować przypadkowe połknięcie.
- Połknięcie baterii może spowodować udławienie i/lub zatrucie.
- Zamontować jednostkę na sztywnej konstrukcji, aby zapobiec nadmiernemu hałasowi lub wibracjom podczas pracy.
- Pomiar hałasu został wykonany zgodnie z normami JIS C9612, JIS B8616, ISO 5151(T1) i ISO 13523(T1).

<HRVATSKI>

Izvornik je na engleskom jeziku. Druge jezične verzije su prijevod izvornika.

▲ OPREZ

- Istjecanje rashladnog sredstva može izazvati gušenje. Osigurajte prozračivanje sukladno normi EN378-1.
- Obvezno omotajte izolaciju oko cijevi. Izravan dodir s golim cijevima može dovesti do opekline ili smrztotina.
- Nikad i ni pod kojim uvjetima ne stavljajte baterije u usta kako ih ne biste slučajno progutali.
- Gutanje baterija može izazvati gušenje i/ili trovanje.
- Uredaj ugradite na čvrstu konstrukciju kako bi se spriječio prejak zvuk ili vibracija pri radu.
- Mjerenje buke obavlja se sukladno normama JIS C9612, JIS B8616, ISO 5151(T1) i ISO 13523(T1).

<БЪЛГАРСКИ>

Оригиналът е на английски език. Версиите на други езици са превод от оригинала.

▲ ВНИМАНИЕ

- Течът на хладилен агент може да причини задушаване. Осигурете вентилация в съответствие с EN378-1.
- Не забравяйте да обвийте тръбите с изолация. Прекият контакт с неизолирани тръби може да доведе до изгаряния или измръзвания.
- Никога не слагайте батерии в устата си по каквато и да било причина, за да избегнете случайно поглъщане.
- Поглъщането на батерии може да причини задавяне и/или отравяне.
- Инсталирайте модула на стабилна подложка, за да предотвратите излишен шум или вибрации вследствие експлоатацията.
- Измерванията на шума се изпълняват в съответствие с JIS C9612, JIS B8616, ISO 5151(T1) и ISO 13523(T1).

<ROMÂNĂ>

Versiunea în limba engleză este originală. Versiunile din celelalte limbi sunt traduceri ale originalului.

▲ ATENȚIE

- Scurgerea agentului frigorific poate provoca sufocarea. Asigurați ventilația în conformitate cu standardul EN378-1.
- Asigurați-vă că izolați țevile. Contactul direct cu țevile neizolate poate duce la arsuri sau degerături.
- Nu introduceți niciodată bateriile în gură pentru a evita ingerarea accidentală.
- Ingerarea bateriilor poate provoca sufocarea și/sau otrăvirea.
- Instalați unitatea pe o structură rigidă pentru a preveni sunetul sau vibrația excesive în timpul funcționării.
- Măsurarea zgomotului este efectuată în conformitate cu standardele JIS C9612, JIS B8616, ISO 5151(T1) și ISO 13523(T1).

<Dansk>

Engelsk er originalsproget. Versionerne på andre sprog er oversættelser af originalversionen.

▲ FORSIGTIG

- Kølemiddellækage kan forårsage kvælning. Sørg for udluftning i overensstemmelse med EN378-1.
- Husk at vikle isolering om rørføringen. Direkte kontakt med uisoleret rørføring kan medføre forbrændinger eller forfrysninger.
- Tag aldrig batterier i munden af nogen årsag for at undgå tilfældig slugning.
- Slugning af batterier kan medføre kvælning og/eller forgiftning.
- Monter enheden på en stiv konstruktion for at undgå meget høje driftslyde eller vibration.
- Støjmåling udføres i overensstemmelse med JIS C9612, JIS B8616, ISO 5151(T1) og ISO 13523(T1).

<Norsk>

Engelsk er originalspråket. De andre språkversjonene er oversettelse av originalen.

▲ Forsiktig

- Kjølemiddellekkasje kan forårsake kvælning. Sørg for ventilasjon i henhold til EN378-1.
- Sikre at du vikler isolasjonen rundt rørene. Direkte kontakt med røret kan føre til forbrenning eller frostbit.
- Batteriene skal aldri plasseres i munnen av noen grunn for å unngå utilsiktet inntak.
- Inntak av batterisyre kan forårsake kvælning og/eller forgiftning.
- Installer enheten på en stødig struktur for å hindre overdreven driftslyd eller vibrasjon.
- Støymåling utføres i henhold til JIS C9612, JIS B8616, ISO 5151(T1) og ISO 13523(T1).

UK DECLARATION OF CONFORMITY

**mitsubishi electric consumer products (thailand) co., ltd.
700/406 moo 7, tambon don hua roh, amphur muang, chonburi 20000, thailand
made in thailand**

hereby declares under its sole responsibility that the air conditioners and heat pumps described below for use in residential, commercial and light-industrial environments:

**mitsubishi electric, pffY-P20VCM-E*, pffY-P25VCM-E*, pffY-P32VCM-E*, pffY-P40VCM-E*, pffY-P50VCM-E*, pffY-P63VCM-E*
pffY-P20VEM-E*, pffY-P25VEM-E*, pffY-P32VEM-E*, pffY-P40VEM-E*, pffY-P50VEM-E*, pffY-P63VEM-E*
* : , , 1, 2, 3, . . . , 9**

Note: Its serial number is on the nameplate of the product.

Legislation

**Electrical Equipment (Safety) Regulations 2016
Supply of Machinery (Safety) Regulations 2008
Electromagnetic Compatibility Regulations 2016
The Restriction of the Use of Certain Hazardous Substances in Electrical and Electronic Equipment Regulations 2012
The Ecodesign for Energy-Related Products and Energy Information (Amendment) (EU Exit) Regulations 2020**

This product is designed and intended for use in the residential,
commercial and light-industrial environment.

Please be sure to put the contact address/telephone number
on this manual before handing it to the customer.

MITSUBISHI ELECTRIC CORPORATION
HEAD OFFICE: TOKYO BLDG., 2-7-3, MARUNOUCHI, CHIYODA-KU, TOKYO 100-8310, JAPAN