

HITACHI

WIRED REMOTE CONTROLLER INSTRUCTION MANUAL

MODEL
SPX-WKT3

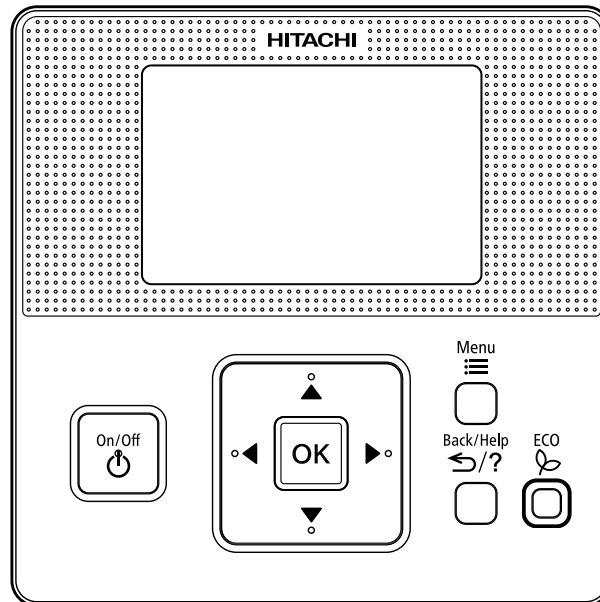

CONTENTS

1. SAFETY PRECAUTIONS	3
2. NAMES AND FUNCTIONS OF REMOTE CONTROLLER	4
3. PREPARATION BEFORE OPERATION	5
3.1 ADJUSTING DATE/TIME	5
3.2 LANGUAGE SETTING	5
4. OPERATION METHOD	5
4.1 OPERATION START/STOP	6
4.2 BASIC OPERATION	6
4.3 OPERATION MODE SELECT	6
4.4 ROOM TEMPERATURE SETTING	6
4.5 FAN SPEED SELECT	7
4.6 AUTO SWING OPERATION	7
4.7 SWING LOUVER DIRECTION(CEILING CASSETTE ONLY)	8
5. MENU OPERATION	9
5.1 MENU	9
5.2 SIMPLE TIMER OPERATION ("Functions" menu)	10
5.3 SLEEP TIMER OPERATION ("Functions" menu)	11
5.4 WEEKLY TIMER OPERATION ("Functions" menu)	12
5.5 LEAVE HOME OPERATION ("Functions" menu)	16
5.6 POWERFUL OPERATION ("Functions" menu)	18
5.7 INFO FUNCTION ("Functions" menu)	19
5.8 FILTER SIGN RESET ("Functions" menu)	19
5.9 CLEAN OPERATION ("Functions" menu)	20
5.10 OPERATION LOCK ("Functions" menu)	21
5.11 DAYLIGHT SAVING TIME("Remocon Settings" menu)	22
6. ECO OPERATION	23
6.1 Eco operation	23
6.2 Eco operation with sensor	23
7. HELP MENU	24
7.1 Help menu	24
7.2 Indication on LCD	24
7.3 About operation	25
7.4 Contact information	25
8. OTHER INDICATIONS	26
8.1 In normal condition	26
8.2 In abnormal condition	26

1. SAFETY PRECAUTIONS

Also see instruction manual attached to the indoor unit.

- Please read the "Safety Precaution" carefully before operating the unit to ensure correct usage of the unit.
- Pay special attention to signs of " ⚠ Warning" and " ⚠ Caution". The "Warning" section contains matters which, if not observed strictly, may cause death or serious injury. The "Caution" section contains matters which may result in serious consequences if not observed properly. Please observe all instructions strictly to ensure safety.
- Be sure that the unit operates in proper condition after installation. Explain to customer the proper operation and maintenance of the unit as described in the user's guide. Ask a customer to keep this installation manual together with the instruction manual.

⚠ WARNING

- Do not pour water into the remote controller. This product is equipped with electrical parts. If poured, it will cause a serious electrical shock.
- Please contact your agent for maintenance. Improper self-maintenance may cause electric shock and fire.
- Please contact your agent if you need to remove and reinstall the remote controller. Electric shock or fire may occur if you remove and reinstall the remote controller yourself improperly.
- Should abnormal situation arise (like burning smell), please stop operating the unit and turn off the circuit breaker. Contact your agent. Fault, short circuit or fire may occur if you continue to operate the unit under abnormal situation.
- The sales agent and qualified technician shall comply with local regulations or standards for the safety.
- Avoid an extended period of direct airflow for your health.
- During thunder storm, turn off the circuit breaker.

⚠ CAUTION

- The product shall be operated under the manufacturer specification and not for any other intended use.
- Do not attempt to operate the unit with wet hands, this could cause fatal accident.
- When operating the unit with burning equipment, regularly ventilate the room to avoid oxygen insufficiency.
- Do not wash the remote controller with water or place a water container such as a vase on the remote controller. Electrical leakage could be present and cause electric shock.
- Be sure to stop the operation by using the remote controller and turn off the circuit breaker during cleaning, electrical leakage could be present and cause electric shock.
- Turn off the circuit breaker if the unit is not to be operated for a long period.
- This appliance is not to be used by children or persons with reduced physical, sensory or mental capabilities, or lack of experience and knowledge, unless they have been given supervision or instruction. Children must be supervised not to play with the appliance.

2. NAMES AND FUNCTIONS OF REMOTE CONTROLLER

The figure below shows all the indications for reference. The actual display during operation is different.

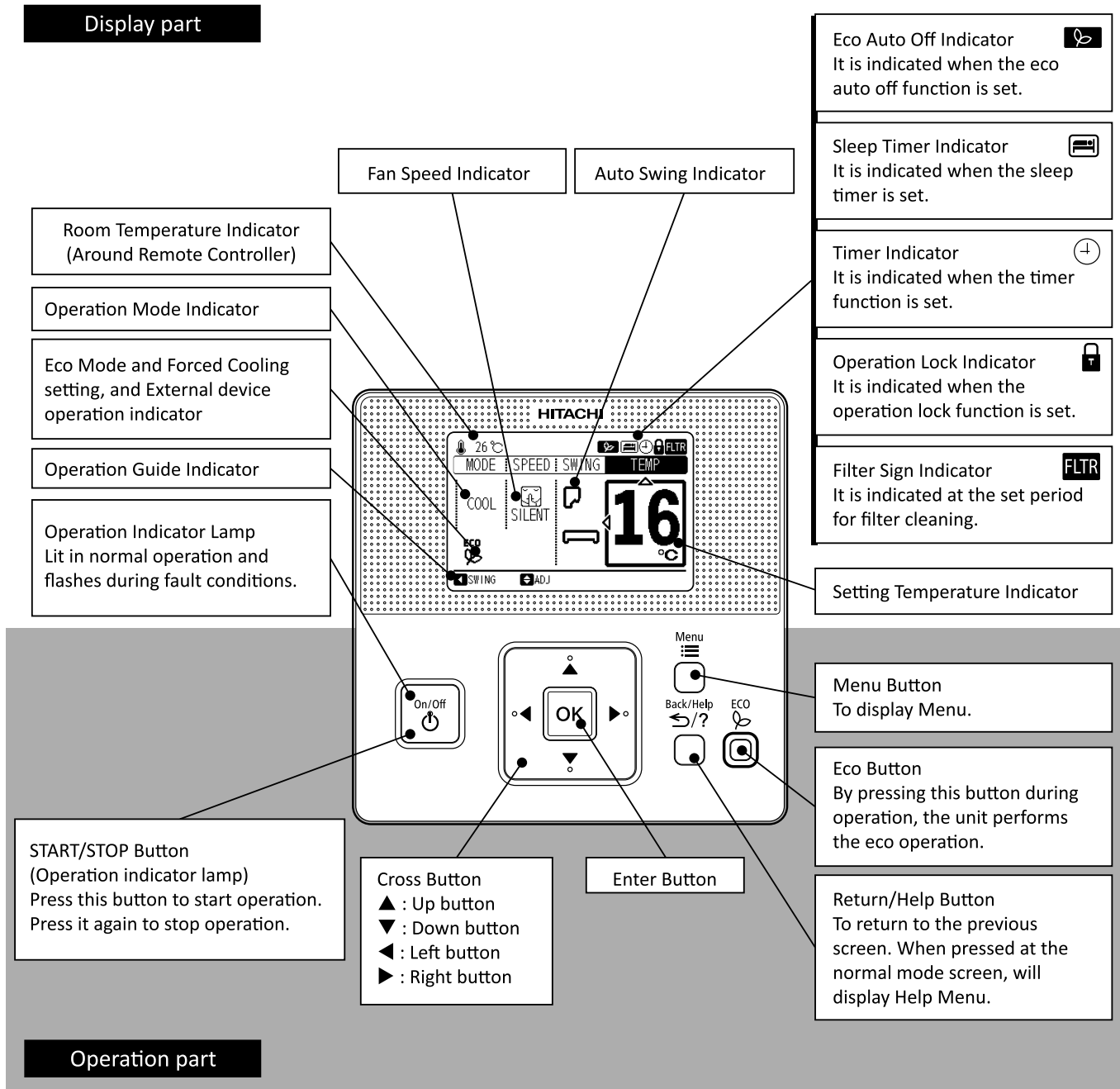

CAUTION

- If this remote controller is connected to the indoor unit, you can not set the timer operation at the wireless remote controller.

NOTE

- Do NOT press the buttons hard or press with sharply pointed material such as a ball point pen. The operation part of the remote controller may be damaged.
- Make sure that the buttons are pressed softly with fingers.

3. PREPARATION BEFORE OPERATION

3.1 ADJUSTING DATE/TIME

This function is used to adjust the date and time.
 Periodic time setting is recommended. (Clock accuracy: difference within +/-5 seconds by month).
 As for this remote controller, the clock can work up to 72 hours when power failure occurs.
 Reset the date and time if the remote controller remains without power supply for longer than 72 hours or main power is OFF for long time.

- 1 Press "Menu" (☰) (menu).
 Select "Remocon Settings" from the menu and press "OK".
- 2 Select "Adjusting Date/Time" from the menu and press "OK".

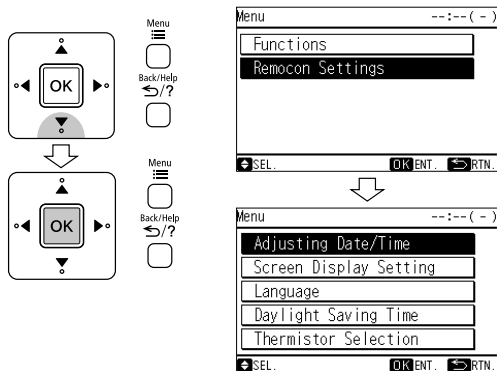

- 3 Press "<" or ">" and select "yy/mm/dd/hh/mm".
- 4 Press "▲" or "▼" to change the setting. Press or keep "▲" or "▼" to adjust numbers.

5 After the setting is completed, press "OK" and the confirmation screen will be displayed.

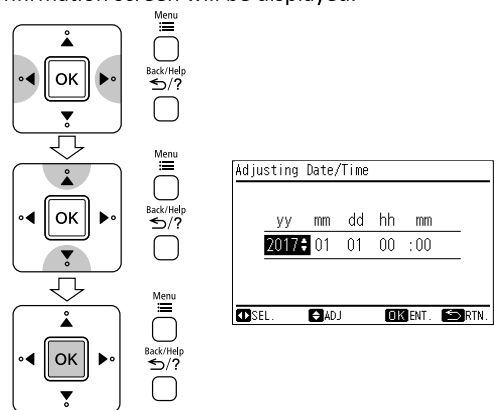

6 Select "Yes" by pressing "<" or ">" and press "OK". The setting will be confirmed and the screen will return to the normal mode.

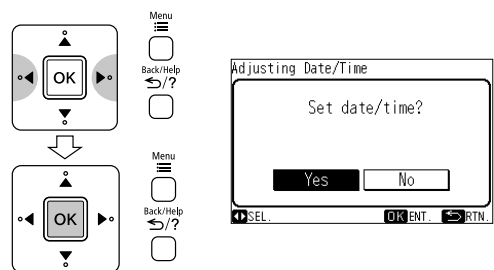

3.2 LANGUAGE SETTING

This function is used to change the displayed language.

- 1 Select "Language" from the menu and press "OK".

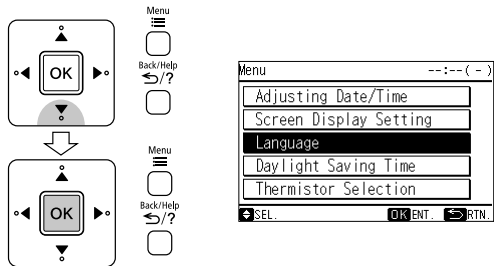

- 2 Press "▲" or "▼" to select the language and press "OK". The confirmation screen will be displayed.

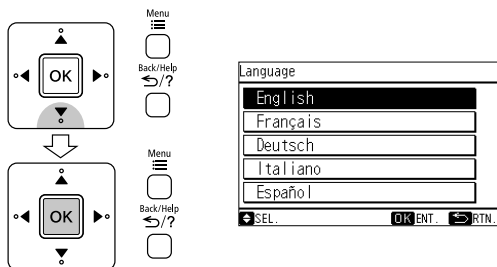

- 3 Select "Yes" by pressing "<" or ">" and press "OK". The setting will be confirmed and the screen will return to the normal mode.

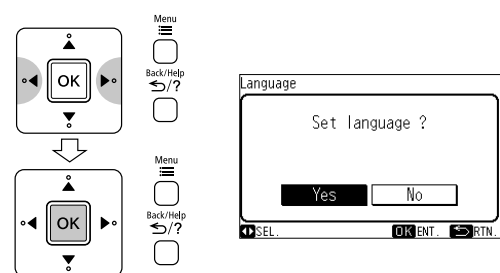

NOTE

- If displayed language is changed, "Contact information" will be deleted.
- Refer to "Contact information" section of Installation manual.

4. OPERATION METHOD

4.1 OPERATION START/STOP

1 Operation start

Press "On/Off" (START/STOP). The operation indicator lamp will be turned on and the operation will be started.

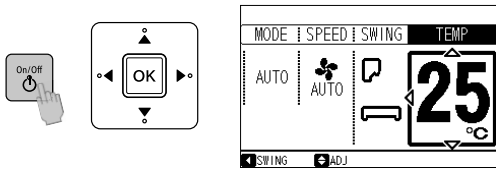

2 Operation stop

Press "On/Off" (START/STOP) again. The operation indicator lamp will be turned off and the operation will be stopped.

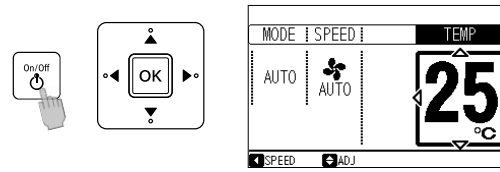

4.2 BASIC OPERATION

1 Item Selection

By pressing "<" or ">", the icon "OK" will move to the next item in order of the indications "MODE", "SPEED", "SWING" and "TEMP".

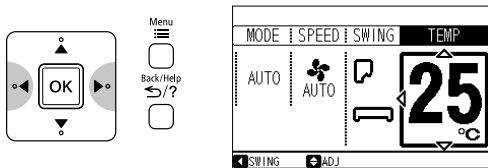

2 Changing Setting

When the item ("MODE", "SPEED", "SWING" OR "TEMP") is selected, press "Δ" or "∇". The setting will be changed.

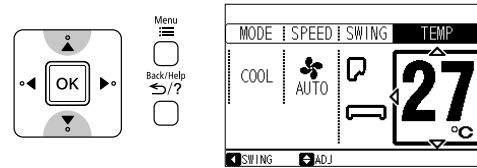

4.3 OPERATION MODE SELECT

1 Press "<" or ">" and select "MODE".

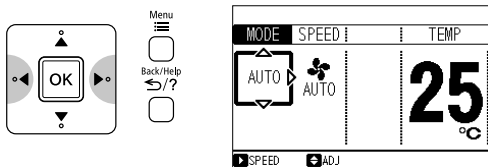

2 By pressing "Δ" or "∇", the operation mode will be changed as follows.

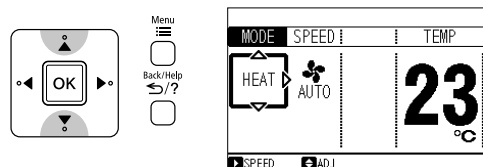

3 MODE Function

- Automatic Operation (AUTO)
To cooling and heating at automatic changeover depending on the current room temperature.
However, the mode of operation will not change, when the indoor unit is connected to multi type outdoor unit.
Temperature range can be set between 16°C and 32°C.
- Heating Operation (HEAT)
To increase the room temperature.
Temperature range can be set between 16°C and 32°C.
- Dehumidifying Operation (DRY)
To decrease the humidity in the room.
Temperature range can be set between 16°C and 32°C.
- Cooling Operation (COOL)
To decrease the room temperature.
Temperature range can be set between 16°C and 32°C.
- Fan Operation (FAN)
To circulate the air in the room.

4.4 ROOM TEMPERATURE SETTING

1 Press "<" or ">" and select "TEMP".

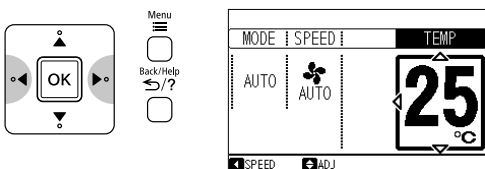

2 By pressing "Δ", the temperature is increased by 1°C. (Max. 32°C)

By pressing "∇", the temperature is decreased by 1°C. (Min. 16°C)

Keep pressing and the value will change more quickly.

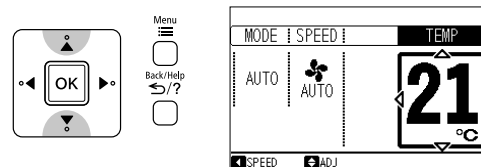

4.5 FAN SPEED SELECT

1 Press "◀" or "▶" and select "SPEED".

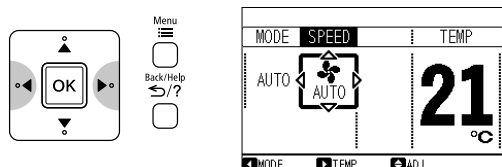

2 By pressing "△" or "▽", the operation mode will be changed as follows.

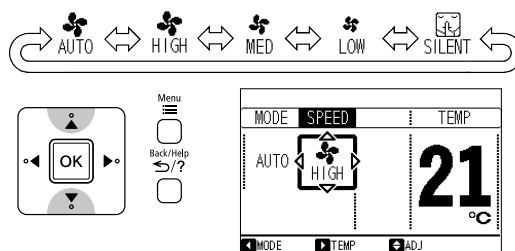

NOTE

- The fan speed of dehumidifying operation can select "LOW" and "SILENT" only.
- The fan speed of fan operation cannot select "AUTO".

4.6 AUTO SWING OPERATION

1 Press "On/Off" (START/STOP). Make sure that the operation started.

Press "◀" or "▶" and select "SWING".

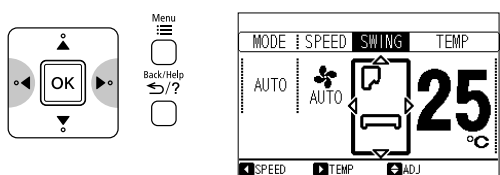

The display for models of vertical and horizontal swing

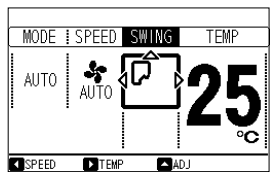



The display for models of vertical swing only

NOTE

- For the indoor unit without the auto swing operation, the indication of "SWING" will not be displayed on LCD.

2 To start/cancel auto swing operation

- VERTICAL SWING 

Press "△". The deflector(s) will start to swing up and down. Press "△" again. The deflector(s) will stop in the current position.
- HORIZONTAL SWING 

Press "▽". The deflectors will start to swing right and left. Press "▽" again. The deflectors will stop in the current position.

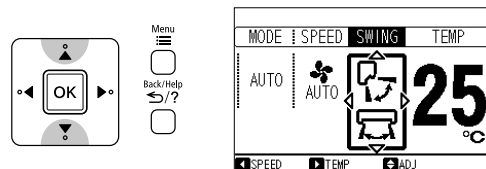

The display for models of vertical and horizontal swing

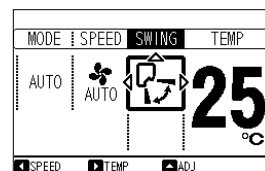



The display for models of vertical swing only



NOTE

- During cooling and dehumidifying operation, do not keep the deflectors swinging or in the lower position (in the case of vertical auto swing) for a long time.
- It may cause dew condensation on the deflectors.

4.7 SWING LOUVER DIRECTION(CEILING CASSETTE ONLY)

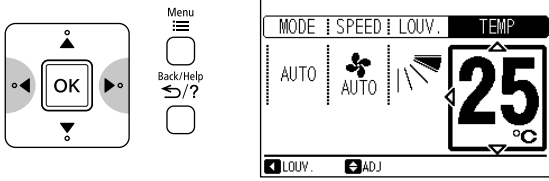
- 1 Press "  " (START/STOP). Make sure that the operation started.
Press "  " or "  " and select "LOUV.".





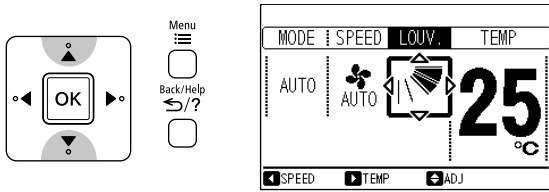









- 2 By pressing "  " or "  ", the louver direction will be changed as follows.



NOTE

- Louver position on LCD and the actual louver position may not match during the auto swing operation.
To fix the louver positions, set the angle after checking the position on LCD.
- The louver may NOT stop immediately right after the button is pressed.

LCD Indication	COOL, DRY FAN, AUTO	HEAT
	Auto-swing	
	↑	↑
	↓	↓
	↑	↑
	↓	↓
	↑	↑
	↓	↓
	↑	↑
	↓	↓
	↑	↑
	↓	↓

 : Auto swing operation will be started.
At this time, the louver will swing repeatedly on LCD.

5. MENU OPERATION

5.1 MENU

All setting functions can be displayed in the menu. Refer to the following sections for each function.

NOTE

☒ : Unable to set

If the function with "☒" is selected from the menu, "Setting Disabled" will be displayed on the lower screen.

1 Press "Menu" (☰).

Select "Functions" or "Remocon Settings" by pressing "△" or "▽" from the menu and press "OK".

NOTE

- The "Functions" menu items vary depending on which is displayed in the stop and in operation.

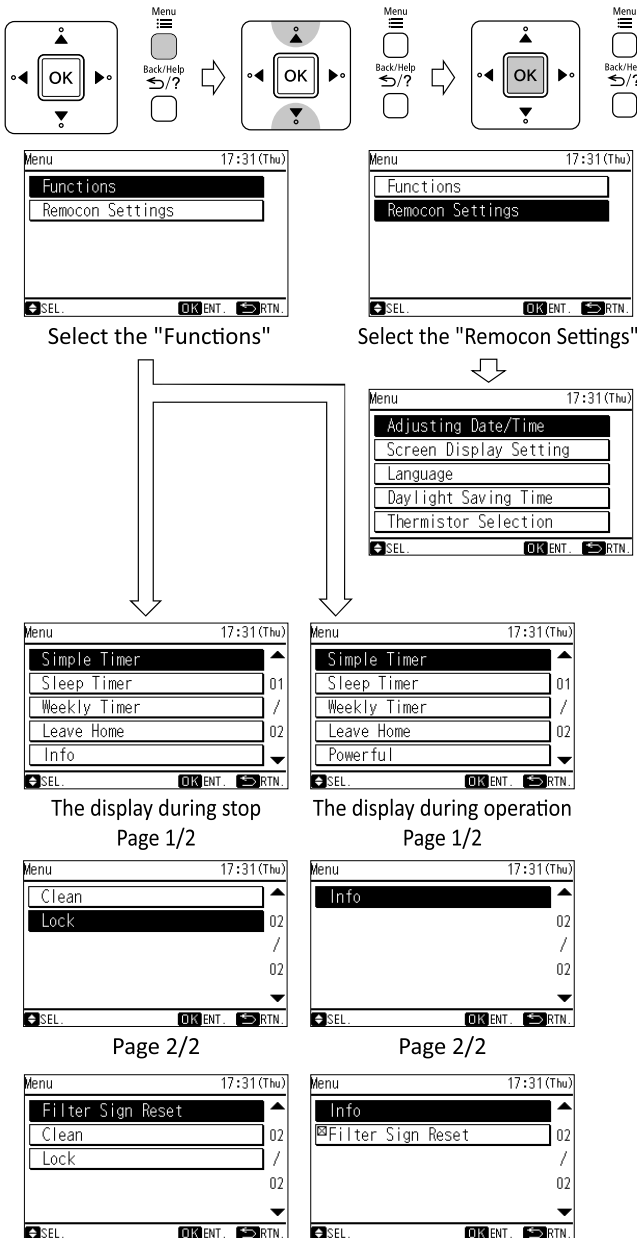

Page 2/2
When "filter sign" is turned on

2 Select the function by pressing "△" or "▽" and press "OK". ("☒" will be displayed if the function is not available.)

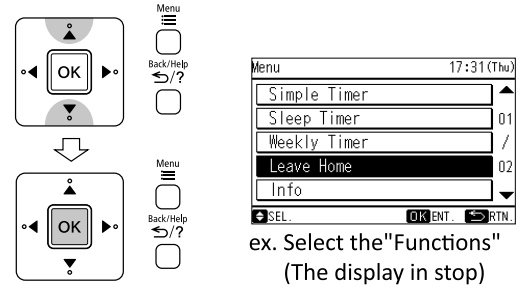

3 Press "Back/Help" (return/help) to return to the first level menu.

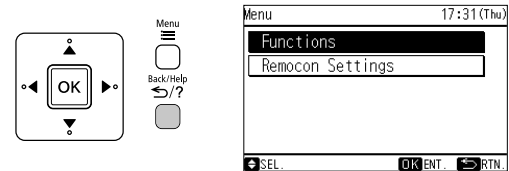

Press "Back/Help" (return/help) again to return to the normal mode. (Operation Mode Indication)

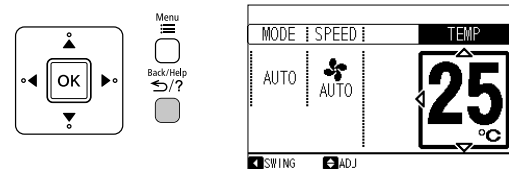

NOTE

- If the menu screen remains unchanged for approximately 10 minutes, the screen will automatically return to the normal mode.

5.2 SIMPLE TIMER OPERATION ("Functions" menu)

This function is used to start or stop the unit operation at the setting time. The timer operation contents can be set from "Once" to "Everyday".

- 1 Select "Simple Timer" from the menu and press "OK".
The simple timer setting will be displayed.

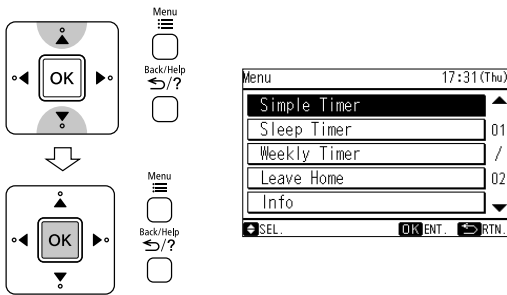

NOTE

- If the present time has not been set yet, automatically "Adjusting Date/Time" will be displayed.
- In this case, "☒" is indicated on LCD of the normal mode.
- Refer to "Adjusting Date/Time" section of this manual.
- When "Sleep Timer" operation is set, this function cannot be set. ("☒" will be displayed if the function is not available.)

- 2 Press "△" or "▽" to select the setting items. The setting items are displayed "Timer Op.", "ON Time" and "OFF Time".

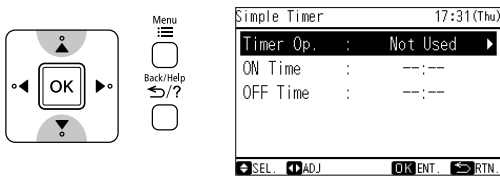

- 3 Press "◀" or "▶" to set each setting content for the selected item. When "Timer Op." is selected, the setting contents are switched in order of "Not Used" <---> "Once" <---> "Everyday" by pressing "◀" or "▶". When "ON Time" or "OFF Time" is selected, the setting time can be set every 10 minutes by pressing "◀" or "▶". Press and hold "◀" or "▶", the setting time will change more quickly.

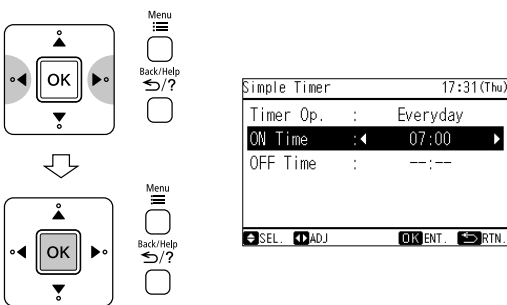

NOTE

- If "Once" of the timer operation setting is selected, the setting content will be automatically changed to "Not Used" after "Once" timer operation.

- 4 Press "OK" to finish the simple timer setting.
The confirmation screen will be displayed.

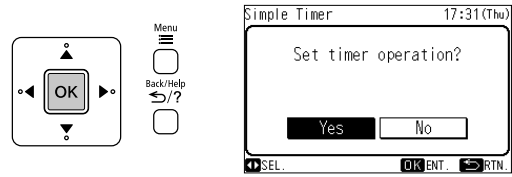

- 5 Select "Yes" by pressing "◀" or "▶" and press "OK".
The setting will be confirmed and the screen will return to the normal mode.

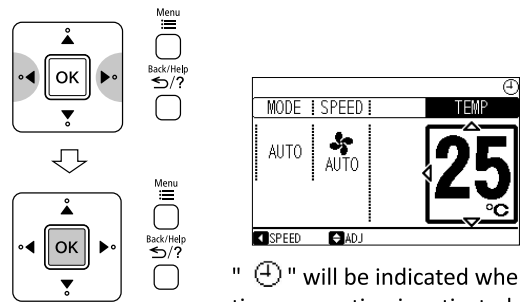

"⌚" will be indicated when the timer operation is activated.

NOTE

- The timer is controlled by this remote controller.
- The timer lamp of indoor unit does not turn on.
- During "Simple timer" operation, if "Leave Home" operation is started, the setting will be automatically changed to "Not Used".

5.3 SLEEP TIMER OPERATION ("Functions" menu)

This function is Off Timer operation to stop the operation if preset time has passed when you sleep.

- 1 Select "Sleep Timer" from the menu and press "OK".
The sleep timer setting will be displayed.

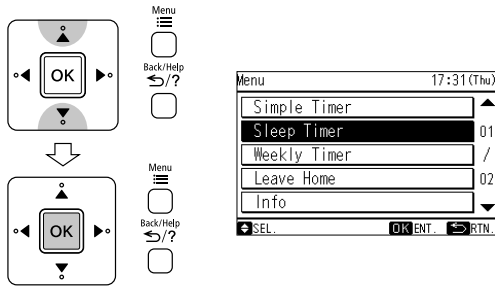

NOTE

- If the present time has not been set yet, automatically "Adjusting Date/Time" will be displayed.
- In this case, "⊗" is indicated on LCD of the normal mode.
- Refer to "Adjusting Date/Time" section of this manual.

- 2 Press "△" or "▽" to select the setting items. The setting items are displayed "Timer Op." and "Set time".



- 3 Press "◀" or "▶" to set each setting content for the selected item. When "Timer Op." is selected, the setting contents are switched in order of "Not Used" <--> "Used" by pressing "◀" or "▶". When "Set time" is selected, the setting time can be set "1 hour", "2 hours", "3 hours" and "7 hours" by pressing "◀" or "▶" cyclically.

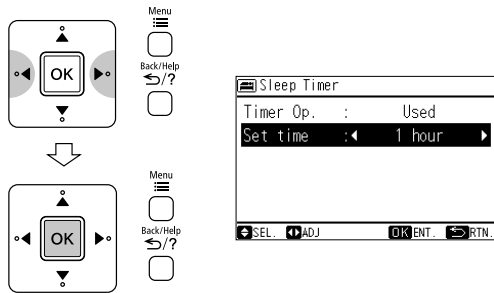

NOTE

- You can set the time of the sleep timer operation within the time range before "ON" timer (Simple timer) preset time.

- 4 Press "OK" to finish the sleep timer setting.
The confirmation screen will be displayed.

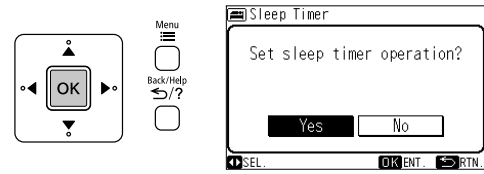

- 5 Select "Yes" by pressing "◀" or "▶" and press "OK".
The setting will be confirmed and the sleep timer operation will be started, then the screen will return to the normal mode.

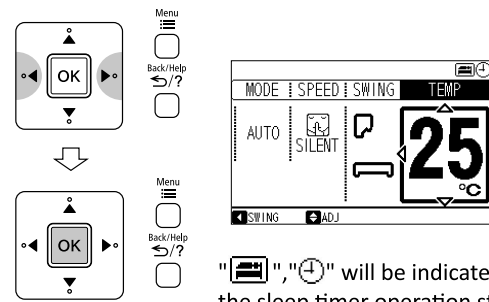

"⏰", "⏰" will be indicated when the sleep timer operation starts.

NOTE

- When the timer is set, this remote controller will send the sleep timer information to indoor unit and the timer lamp of indoor unit turns on.

5.4 WEEKLY TIMER OPERATION ("Functions" menu)

5.4.1 Weekly schedule setting

This function is used to start or stop the unit operation at the setting time.

Temperature can be also set when the unit is operated.

Five different schedule timers (max.) can be set for each day of the week.

1 Select "Weekly Timer" from the menu and press "OK".

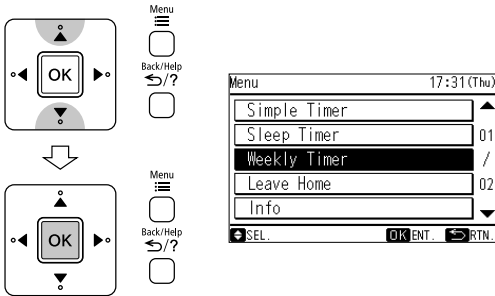

2 Select "Day/Time Setting" by pressing " Δ " or " ∇ " and press "OK".

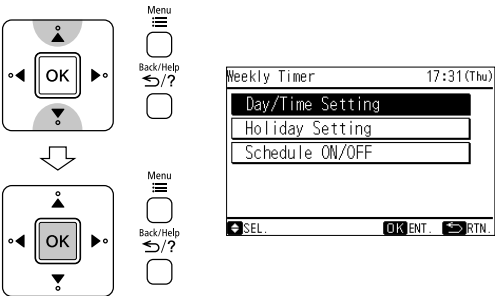

NOTE

- If the present time has not been set yet, automatically "Adjusting Date/Time" will be displayed.
- In this case, "☒" is indicated on LCD of the normal mode.
- Refer to "Adjusting Date/Time" section of this manual.
- When "Sleep Timer" operation is set, this function cannot be set. ("☒" will be displayed if the function is not available.)

3 Select the day of the week (from Monday to Sunday) by pressing " Δ " or " ∇ ". Press "OK".

- "■" (operation) and "□" (stop) will be displayed on LCD.

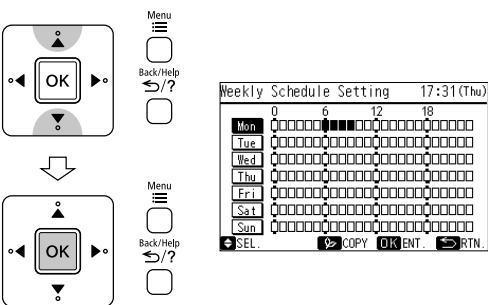

4 Select the schedule No.(from 1 to 5) by pressing " Δ " or " ∇ ". Select "ON Time", "OFF Time" or "Setting Temperature" by pressing " \triangleleft " or " \triangleright ". Set the ON/OFF timer and temperature by pressing " Δ " or " ∇ ".

- Press or keep pressing " Δ " or " ∇ " to adjust numbers.

- When "ON Time" or "OFF Time" is selected, the setting time can be set every 1 minute by pressing " Δ " or " ∇ ". Press and hold " Δ " or " ∇ ", the setting time will change more quickly. (10 minutes acceleration)
- Five different schedule timers (max.) can be set for each day of the week.

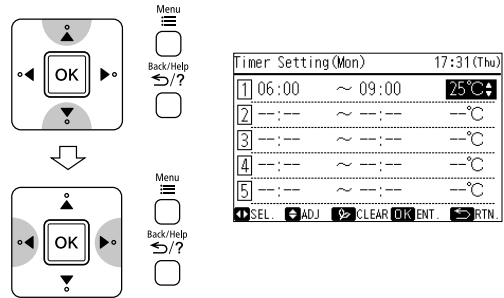

The figure shows that following timers are set for Monday;
ON Timer : 6:00
OFF Timer : 9:00
Setting Temperature: 25°C

5 Press "OK". The confirmation screen will be displayed.

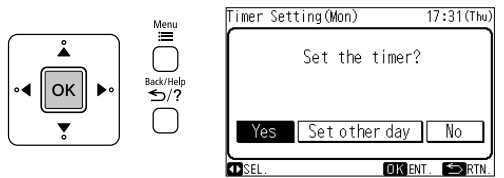

6 Select "Yes" by pressing " \triangleleft " or " \triangleright " and press "OK".

The setting will be confirmed and the screen will return to the normal mode.
To set other days of the week, select "Set other day" and press "OK".

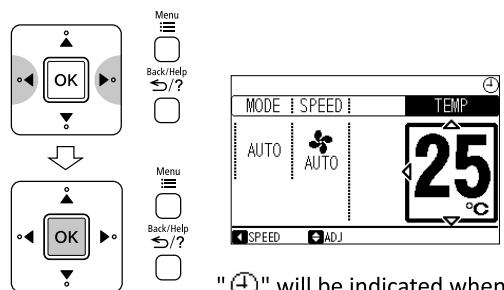

"🕒" will be indicated when the weekly timer operation is activated.

NOTE

- The timer is controlled by this remote controller.
- The timer lamp of indoor unit does not turn on.

5.4.2 Copy and cancel the reservation schedule

◆ How to copy and paste

- 1 Select "Weekly Timer" from the menu and press "OK".
 Select "Day/Time Setting" by pressing "△" or "▽" and press "OK".
 "Weekly Schedule Setting" screen will be displayed.

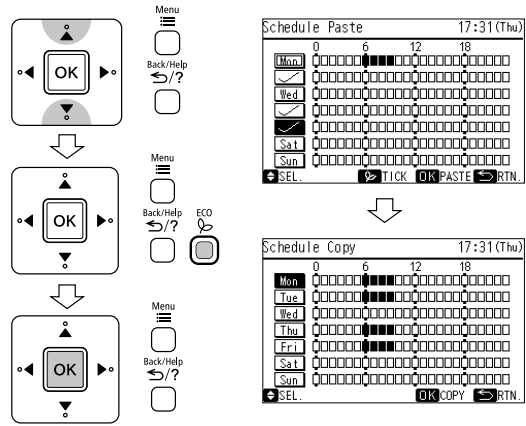
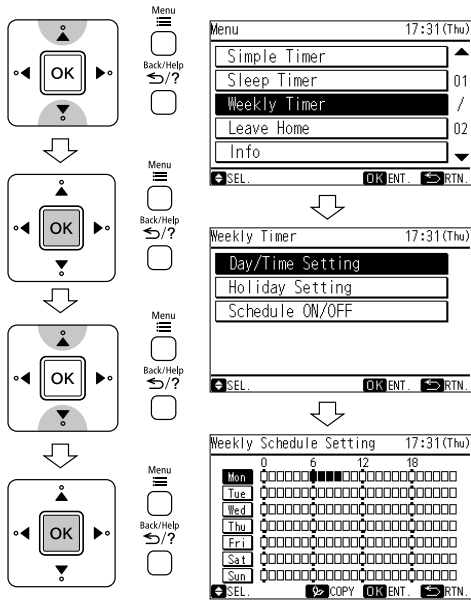

NOTE

- The schedule is not yet memorized at this section.

- 4 Press "Back/Help" (return/help) to return to "Weekly Schedule Setting" screen.

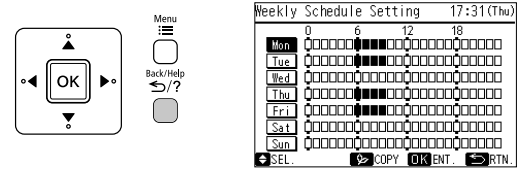

- 2 Select the day of the week to copy by pressing "△" or "▽".
 Press "ECO". Select the day of copy based schedule by pressing "OK".

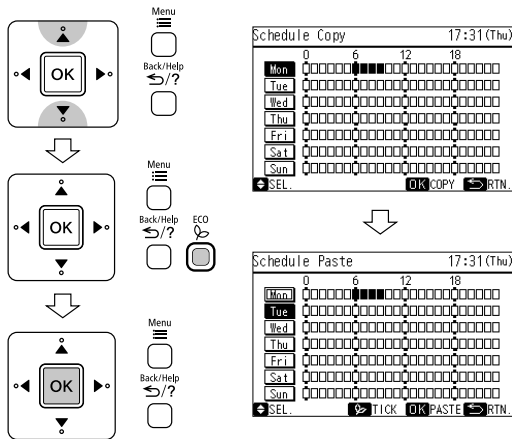

The copy base day of the week is displayed in a double frame.

- 3 Select the day of the week to paste by pressing "△" or "▽".
 Press "ECO", the selected day of the week are displayed in "☑" or "☐".
 Press "OK", the copy based schedule is pasted in the selected day of the week.

- 5 Press "OK" to check the timer setting.
 If the contents to timer setting is OK, press "OK" again.
 The confirmation screen will be displayed.

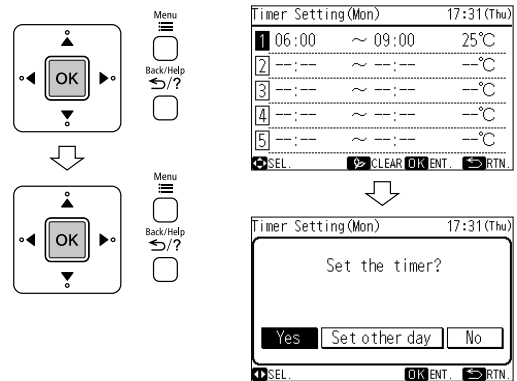

- 6 Select "Yes" by pressing "◀" or "▶" and press "OK".
 The setting will be confirmed and the screen will return to the normal mode. The schedule is memorized.
 To set other days of the week, select "Set other day" and press "OK".

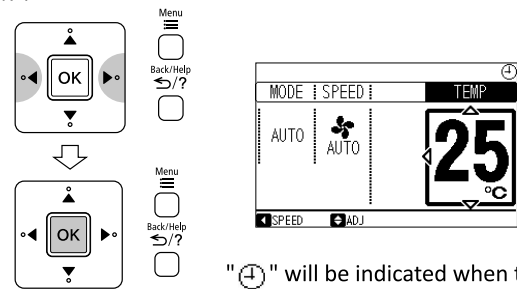

"⌚" will be indicated when the weekly timer operation is activated.

◆ How to delete "Weekly schedule setting"

1 Select "Weekly Timer" from the menu and press "OK".
 Select "Day/Time Setting" by pressing "△" or "▽" and press "OK".

"Weekly Schedule Setting" screen will be displayed.

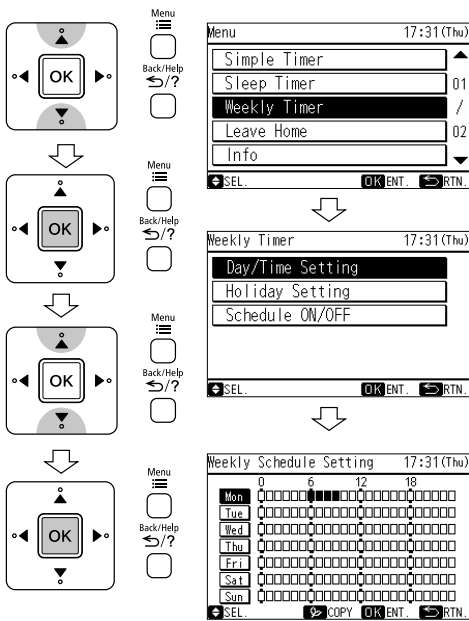

2 Select the day of the schedule you want to delete by pressing "△" or "▽". Press "OK".

"Timer Setting" screen will be displayed.

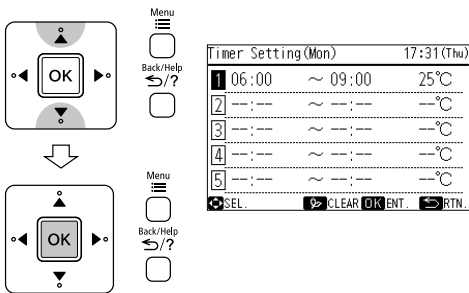

3 Select the schedule No.(1 to 5) you want to delete by pressing "△" or "▽". Press "ECO".

The timer clear screen will be displayed.
 Press "OK", the schedule will be deleted.

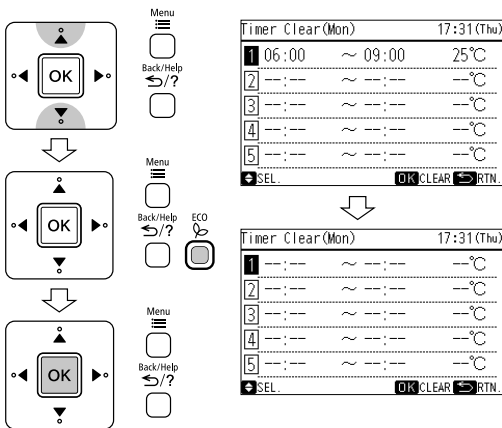

NOTE

- The deleted schedule is not yet memorized at this section.

4 Press "Back/Help" (return/help) to return to "Timer Setting" screen.
 Press "OK". The confirmation screen will be displayed.

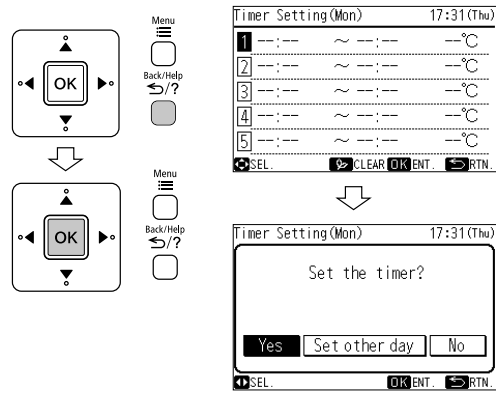

5 Select "Yes" by pressing "◀" or "▶" and press "OK".

The setting will be confirmed and the screen will return to the normal mode. The schedule is memorized.

To set other days of the week, select "Set other day" and press "OK".

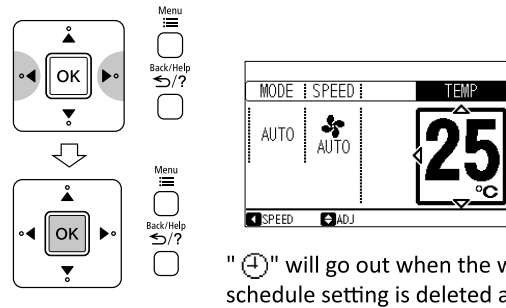

"ECO" will go out when the weekly schedule setting is deleted all.

5.4.3 Holiday setting

This function is used to deactivate the schedule operation temporarily.

This function is used to deactivate the schedule operation just for one day. After that, the schedule operation will recover automatically.

This function is used to set irregular schedules such as national holidays.

- 1 Select "Weekly Timer" from the menu and press "OK".
Select "Holiday Setting" by pressing " Δ " or " ∇ " and press "OK".

"Holiday Setting" screen will be displayed.

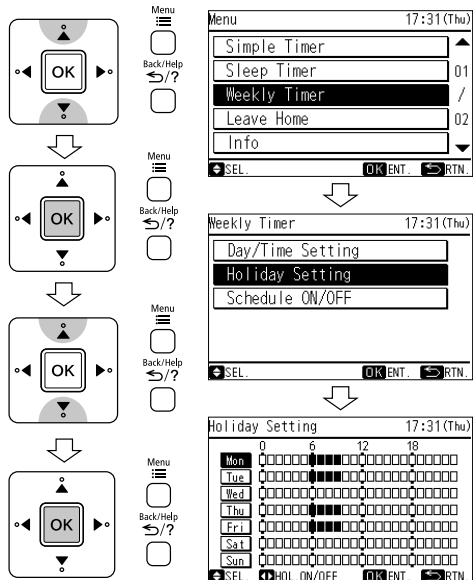

- 2 Select the day of the week to stop the operation by pressing " Δ " or " ∇ ".

Select "HOL. ON/OFF" by pressing " \leftarrow " or " \rightarrow ".
"■" and "□" will be changed to "■" and "□" on LCD.

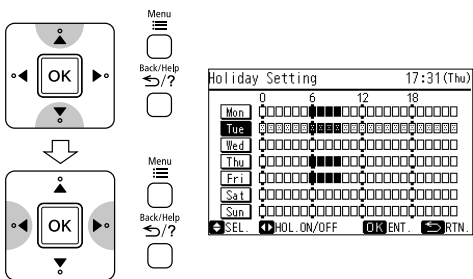

- 3 Press "OK" after the setting is completed. The confirmation screen will be displayed.

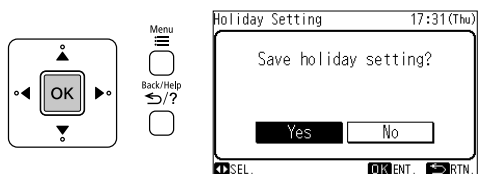

- 4 Select "Yes" by pressing " \leftarrow " or " \rightarrow " and press "OK".
The holiday setting will be confirmed and the screen will return to the normal mode.

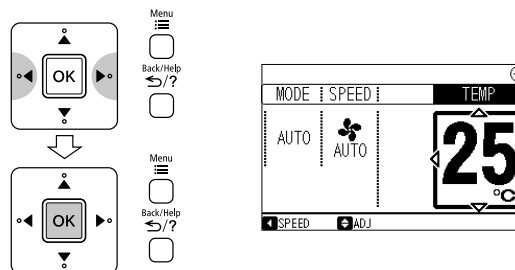

NOTE

- "⊕" will be turned off when the holiday setting is activated.

5.4.4 Schedule ON/OFF setting

This function is used to deactivate the schedule operation temporarily.

The schedule operation will not be carried out when "OFF" is set in this function.

This function is used to apply for long period of holidays.

- 1 Select "Weekly Timer" from the menu and press "OK".

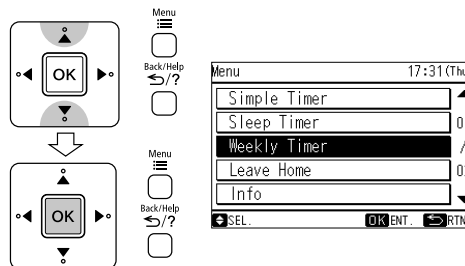

- 2 Select "Schedule ON/OFF" by pressing " Δ " or " ∇ " and press "OK". The confirmation screen will be displayed.

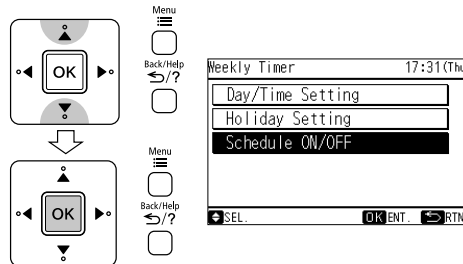

- 3 Select "Yes" by pressing " \leftarrow " or " \rightarrow " and press "OK".
The holiday setting will be confirmed and the screen will return to the normal mode.

"⊕" will be turned on when the setting of schedule operation is valid.

"⊕" will be turned off when the setting of schedule operation is invalid.

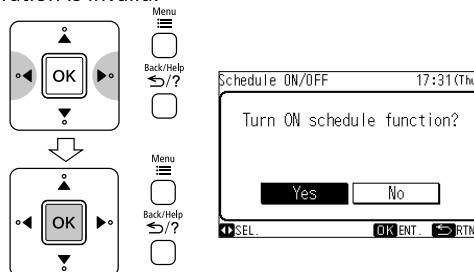

NOTE

- The default setting of this setting is "ON".
- When the setting of schedule operation is invalid, the schedule operation will not be activated.
- If "Leave Home" operation is started, "Schedule ON/OFF" setting will be automatically changed to "OFF".

5.5 LEAVE HOME OPERATION ("Functions" menu)

Prevent the room temperature from falling too much when no one is at home. The initial setting temperature is 10°C and the temperature range can be set between 10°C and 16°C. This operation is able to operate by "Continuous operation" or "Day timer operation". Please use "Day timer operation" to set the number of days up to 99 days.

5.5.1 Continuous operation

1 During stop or operation, select "Leave Home" from the menu and press "OK".

The screen of "Set Period ?" selection will be displayed.

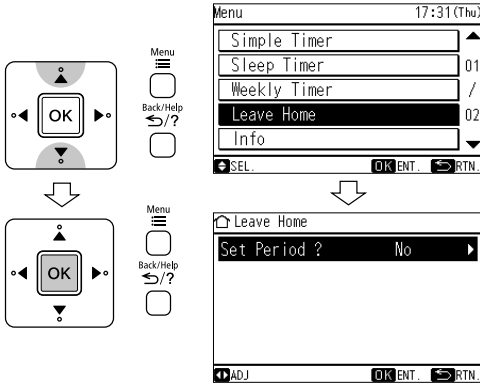

2 Select "No" in the continuous operation and press "OK". The confirmation screen will be displayed.

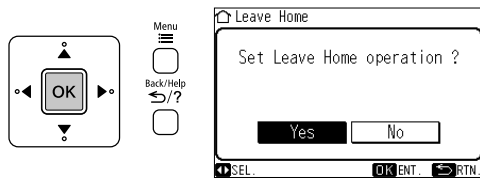

3 Select "Yes" by pressing "<" or ">" and press "OK".

The leave home operation will be started and the screen will return to the normal mode. (Leave home operation display)

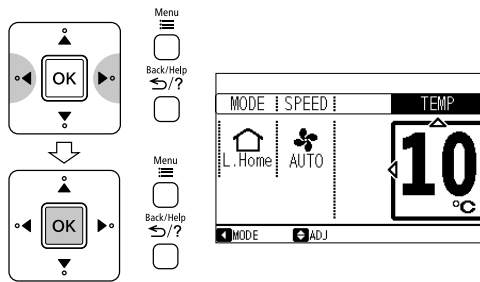

4 Set the temperature by pressing "△" or "▽".

Temperature range can be set between 10°C and 16°C. Keep pressing and the value will change more quickly.

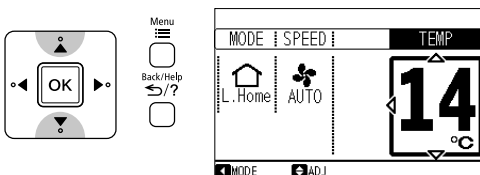

5.5.2 Day timer operation

1 During stop or operation, select "Leave Home" from the menu and press "OK".

The screen of "Set Period ?" selection will be displayed.

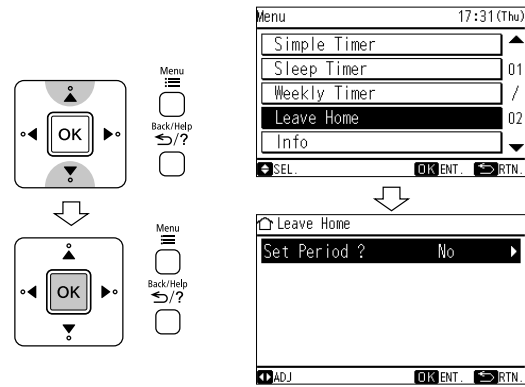

2 Select "Yes" in the day timer operation by pressing ">" and select "Nb of days ?" by pressing "▽". Set number of days (1 to 99 days) by pressing "<" or ">" and press "OK". The confirmation screen will be displayed.

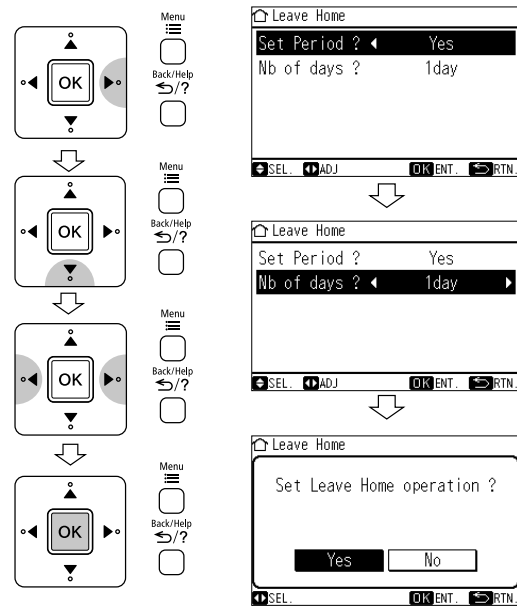

NOTE

- If the present time has not been set yet, automatically "Adjusting Date/Time" will be displayed.
- In this case, "X" is indicated on LCD of the normal mode.
- Refer to "Adjusting Date/Time" section of this manual.

3 Select "Yes" by pressing "<" or ">" and press "OK".

The leave home operation will be started and the screen will return to the normal mode. (Leave home operation display)

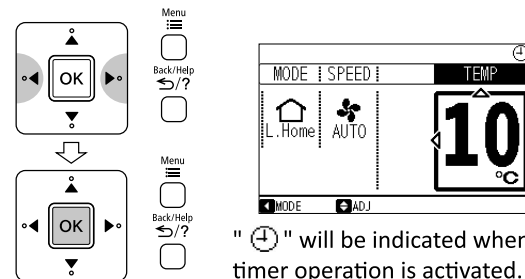

"🕒" will be indicated when the day timer operation is activated.

NOTE

- The timer is controlled by this remote controller.
- The timer lamp of indoor unit does not turn on.
- Number of day is counted when clock indicates 0:00.

- 4 Set the temperature by pressing "△" or "▽".
 Temperature range can be set between 10°C and 16°C.
 Keep pressing and the value will change more quickly.

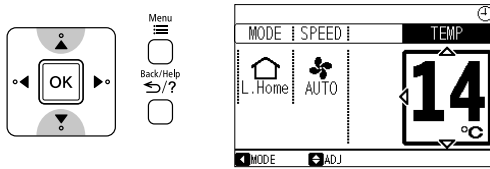

- After reaching the set number of operation days for leave home or leave home operation is canceled, the unit will operate in previous mode.
- Powerful and Eco operations are not applicable during leave home operation.
- For multi connection:
 - Fan/Cooling/Dehumidifying and leave home cannot operate at the same time. The first-run unit has a priority and other units in different mode will be in standby mode.
 - Heating operation can be used with leave home.
 - When two or more rooms are set to operate leave home, the temperature set by leave home may not be reached. It also depends on outdoor temperature.

5.5.3 To cancel leave home operation

- Press "On/Off" (START/STOP). Or

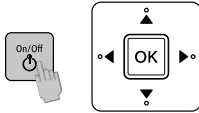

- Select "Leave Home" from the menu and press "OK".
 The confirmation screen will be displayed.
 Select "Yes" by pressing "<" or ">" and press "OK". Or

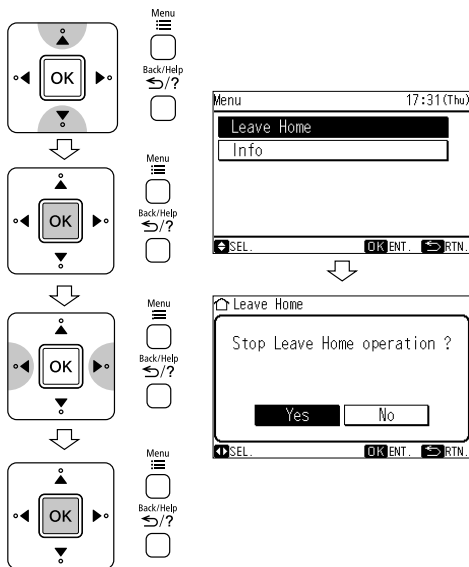

NOTE for Timer Operation

- The timer lamp indication of indoor unit when the timer operation set in this remote controller.

The kind of Timer operation	Timer lamp indication of indoor unit
Simple timer	OFF
Sleep timer	ON
Weekly timer	OFF
Day timer of leave home	OFF

- If this remote controller is connected to the indoor unit, you cannot set the timer operation at the wireless remote controller.

- Change to other operation mode.
 Press "<" and select "MODE". By pressing "△" or "▽", the leave home operation will be canceled and the operation mode is changed.

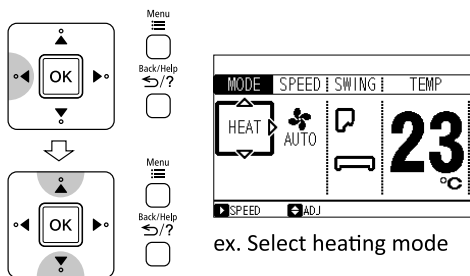

NOTE

- During leave home operation, fan speed and air deflector's position cannot be changed.
- When leave home operation is started, implementation of "Simple timer" or "Weekly timer" is canceled.

5.6 POWERFUL OPERATION ("Functions" menu)

"Powerful" operation is set during operation (Auto, Heating, Dehumidifying and Cooling of Fan), the air conditioner performs at the maximum power.

5.6.1 To START "Powerful" operation

- 1 Select "Powerful" from the menu and press "OK".
The confirmation screen will be displayed.

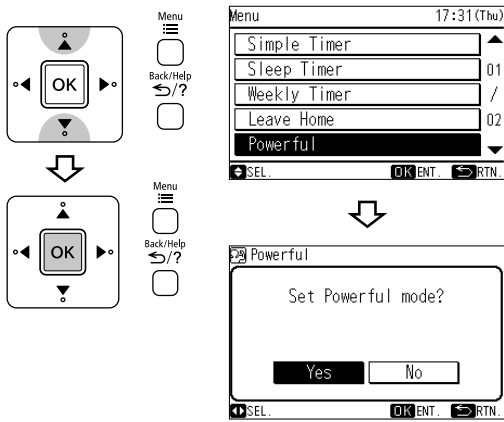

- 2 Select "Yes" by pressing "<" or ">" and press "OK".
The setting will be confirmed and the powerful operation will be started, then the screen will return to the normal mode.

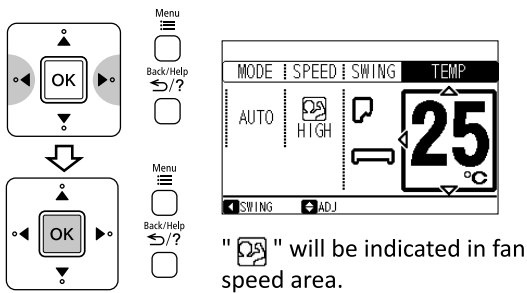

"Powerful" operation ends in 20 minutes. Then the system automatically operates with the previous settings used before powerful operation.

5.6.2 To cancel "Powerful" operation

- Press "On/Off" (START/STOP). Or

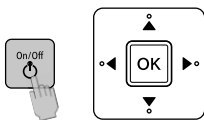

- Select "Powerful" from the menu and press "OK".
The confirmation screen will be displayed.
Select "Yes" by pressing "<" or ">" and press "OK". Or

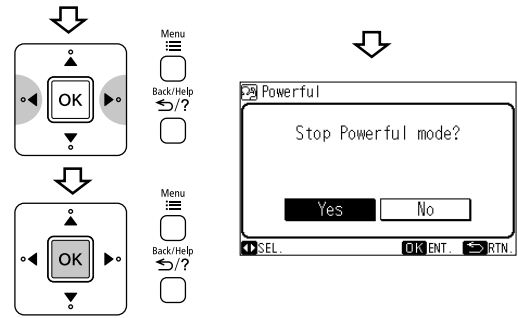
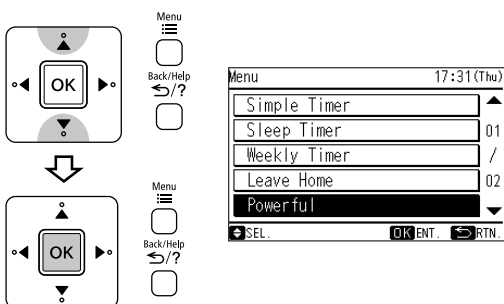

- Change to fan speed. Press "<" or ">" and select "SPEED".
By pressing "△" or "▽", the powerful operation will be canceled and the fan speed is changed.

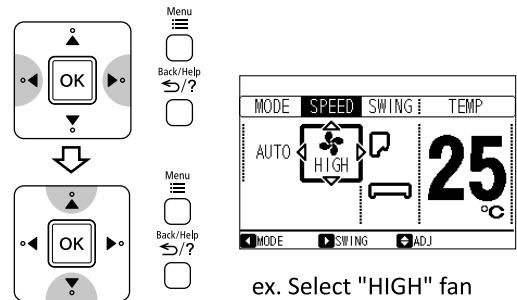

NOTE

- When "Sleep timer", "Eco" or "Leave home" operation is selected, "Powerful" operation is canceled.
- During "Powerful" operation, capacity of the air conditioner will not increase.
 - if the air conditioner is already running at maximum capacity.
 - just before defrost operation (when the air conditioner is running in Heating operation).
- For multi model connections, "Powerful" operation may not function depending on operation conditions.

5.7 INFO FUNCTION ("Functions" menu)

This is the function to display the monthly power consumption on the remote controller screen.

- 1 Select "Info" from the menu and press "OK".
The receiving screen will be displayed.

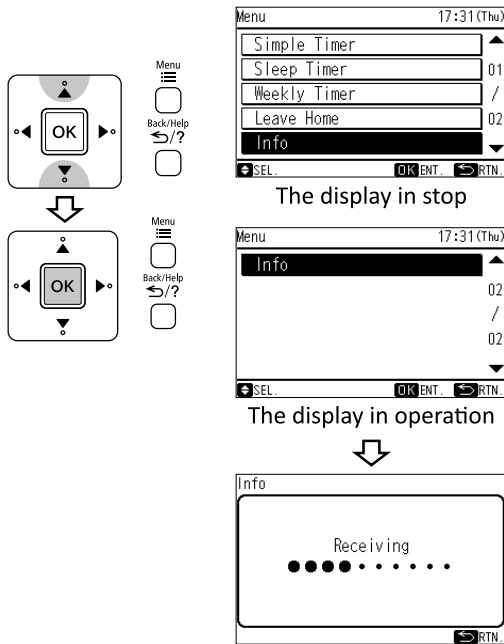

- 2 The heating power consumption will be displayed.
Press "△" or "▽", the cooling power consumption will be displayed.
Press "△" or "▽" repeatedly, the heating power consumption and the cooling power consumption will be displayed alternately.

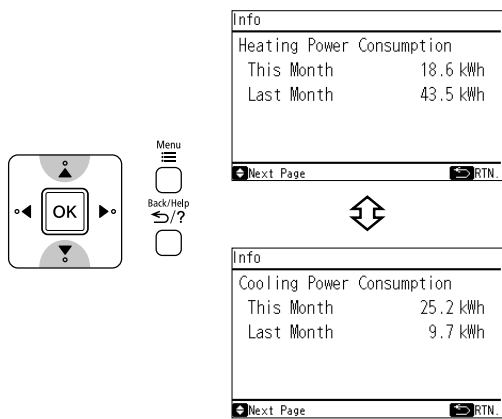

NOTE

- Indicated value shall be regarded as a guide only.

5.8 FILTER SIGN RESET ("Functions" menu)

When the unit is operated for a total of about 200 hours, "FLTR" will be indicated on the screen of normal mode, it is time to clean the filter.

This function is used to turn off the filter sign indication.
(Except auto filter cleaning models)

- 1 When unit is OFF, select "Filter Sign Reset" from the menu and press "OK".
The confirmation screen will be displayed.

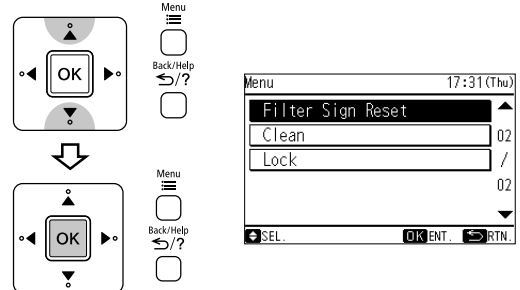

- 2 Select "Yes" by pressing "<" or ">" and press "OK".

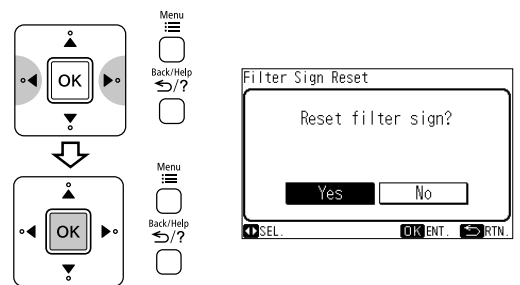

"FLTR" will disappear from the screen of normal mode.

NOTE

- If during operation this  is indicated then function cannot be selected.

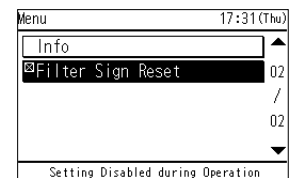

5.9 CLEAN OPERATION ("Functions" menu)

Drying indoor heat exchanger after cooling operation to prevent mildew.

5.9.1 To start "Clean" operation

1 When unit is OFF, select "Clean" from the menu and press "OK". The confirmation screen will be displayed.

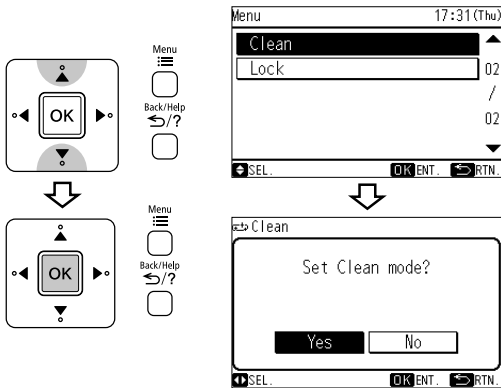

2 Select "Yes" by pressing "<" or ">" and press "OK".

The setting will be confirmed and the clean operation will be started, then the screen will be displayed the clean operation mode.

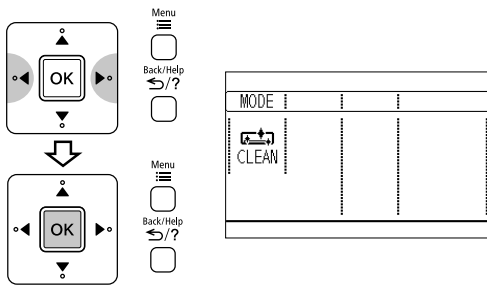

- Total time taken for "Clean" operation is 60 minutes.
- During this operation, Heating or Fan operation shall operate.
- During this operation, the operation lamp of indoor unit is blinking.

5.9.2 To cancel "Clean" operation

- Press "On/Off" (START/STOP). Or

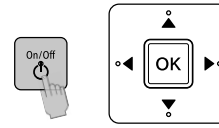

- Select "Clean" from the menu and press "OK". The confirmation screen will be displayed. Select "Yes" by pressing "<" or ">" and press "OK".

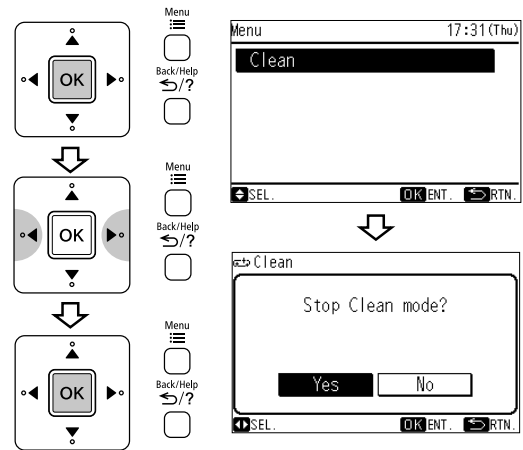

The clean operation will be stopped and the screen will be displayed the normal mode.

NOTE

- When clean operation is finished, unit will stop automatically.
- If Weekly Timer or Simple Timer is set, there is a need to cancel those timers before operating "Clean" function.
- For multi connection :
 - When starts "Clean" operation, operation is limited to "Fan" operation.
 - When one room operates "Clean" operation first, other rooms can operate "Cooling", "Dehumidifying" or "Fan" operation. However, when other rooms need to operate "Heating" operation, air conditioner will be in STANDBY mode. After "Clean" operation finish, "Heating" operation will start.

5.10 OPERATION LOCK ("Functions" menu)

This function is used to lock the operation mode from the remote controller.

The remote controller can be set to fix the "Heating" mode (including "Fan"), "Cooling" mode and "Dehumidifying" mode (including "Fan") operations.

1 When unit is OFF, select "Lock" from the menu and press "OK". The screen of "Mode Lock" selection will be displayed.

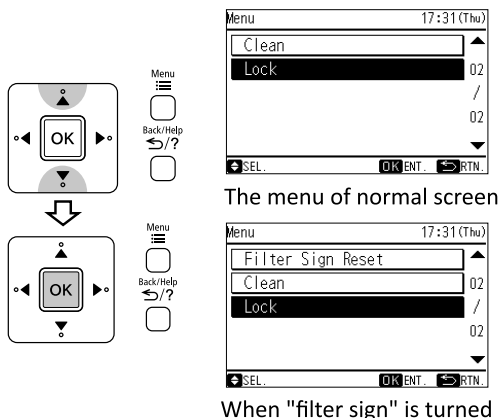

The menu of normal screen

When "filter sign" is turned on

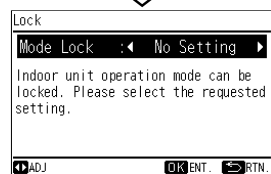

2 By repeatedly pressing "<" or ">", the indication is changed in order of "No Setting" <---> "COOL" <---> "HEAT" Select the function target and press "OK". The confirmation screen will be displayed.

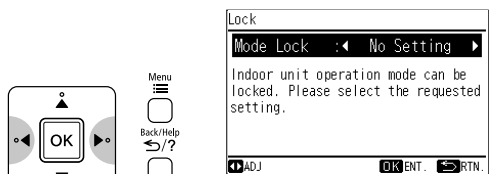

When this function is not used

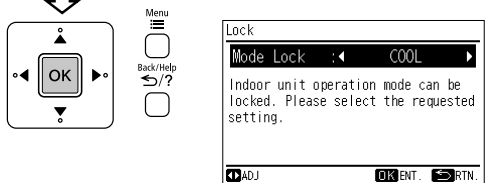

When "Cooling" mode lock is selected

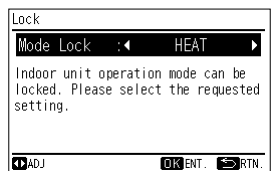

When "Heating" mode lock is selected

3 Select "Yes" by pressing "<" or ">" and press "OK".

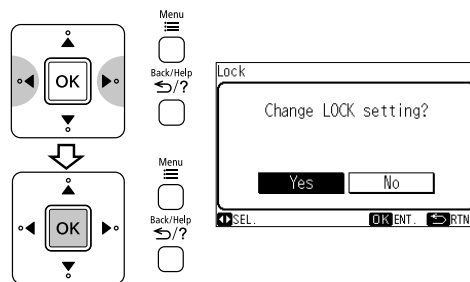

The operation lock will be set and "🔒" will be indicated on the screen of normal mode.

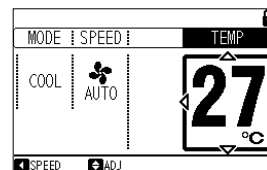

ex. Select "Cooling" mode lock

NOTE

- This function will not activate if "Timer" reservations activate. "Timer" reservations shall be deactivated first. Then, this function can be activated.
- If power failure happens, the lock setting will disappear. You may need to set again.
- For multi connection, unit and mode which is set to lock "Heating" and switched on first shall have higher priority. Other units which are chosen to operate at different modes shall be in "Standby" until either the first unit operation is switched off or the model is selected to be same as the first unit.

5.11 DAYLIGHT SAVING TIME ("Remocon Settings" menu)

This function adjusts time forward or backward an hour when daylight saving time starts or ends.

5.11.1 To start Daylight Saving Time

1 Select "Daylight Saving Time" from the menu and press "OK".

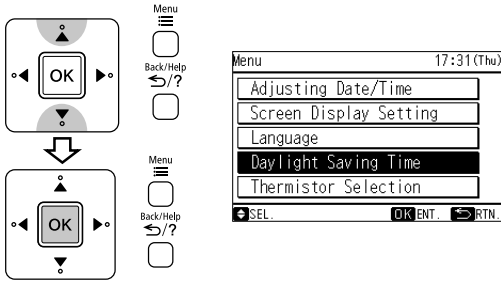

2 The "Daylight Saving Time" screen displays. Select "Set 1h forward" by pressing " Δ " or " ∇ " and press "OK".

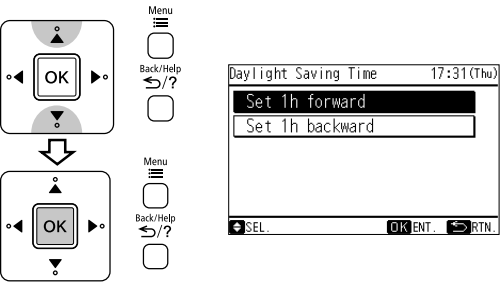

3 The confirmation screen will be displayed.

Select "Yes" by pressing " \triangleleft " or " \triangleright " and press "OK" to confirm the setting.
The screen will return to the normal mode.

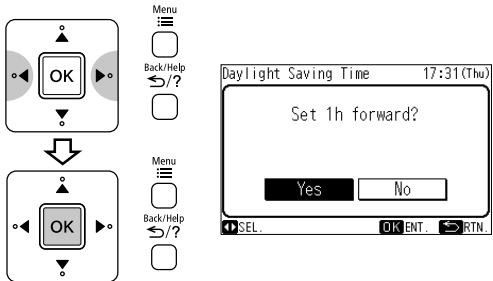

5.11.2 To stop Daylight Saving Time

1 Select "Daylight Saving Time" from the menu and press "OK".

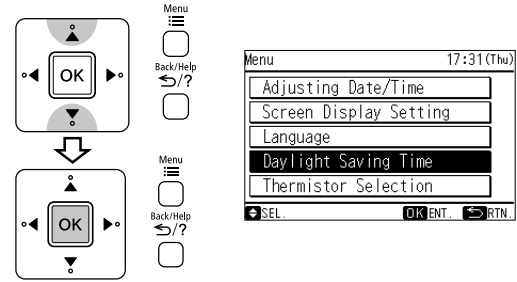

2 The "Daylight Saving Time" screen displays. Select "Set 1h backward" by pressing " Δ " or " ∇ " and press "OK".

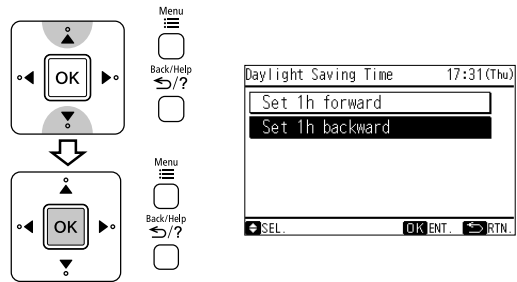

3 The confirmation screen will be displayed.

Select "Yes" by pressing " \triangleleft " or " \triangleright " and press "OK" to confirm the setting.
The screen will return to the normal mode.

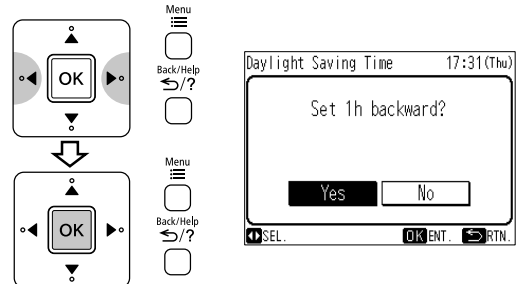

6. ECO OPERATION

There are two kinds of "Eco operation" with sensor or without sensor, depending on models.

Please refer to [Names and Functions of each part] in the unit instruction manual to verify if your unit is equipped with a sensor and read the following instruction on "Eco operation" accordingly.

6.1 Eco operation

"Eco" operation is an energy saving function by changing set temperature automatically and by limiting the maximum power consumption value.

1 To start "Eco" operation

- Press "ECO" (eco) during operation.

"ECO" will be indicated on the screen of normal mode. Energy saving operation will start by changing the set temperature higher or lower automatically and reducing operation power consumption. This function may vary based on the connected outdoor unit.

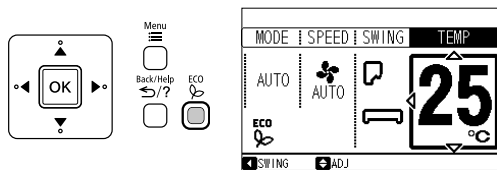

2 To cancel "Eco" operation

- Press "On/Off" (START/STOP). Or

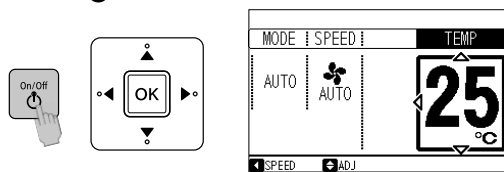

- Press "ECO" (eco) again.

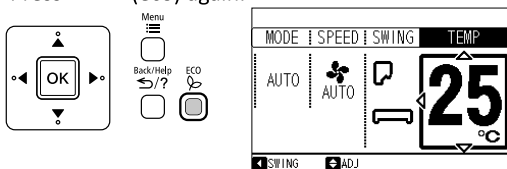

NOTE

- Eco operation will not be effective when power consumption is low.
- When "Powerful" operation is set, "Eco" operation is canceled.
- After auto restart, "Eco" operation is canceled and previous operation mode shall start.
- For multi model connections, energy saving operation shall start only by changing set temperature higher or lower automatically. However, effectiveness of "Eco" depends on operation conditions.

6.2 Eco operation with sensor

The sensor detects the presence of people in the room. When nobody is detected, the unit automatically starts energy saving operation by shifting the set temperature in two steps.

1 To start "Eco" operation

- Press "ECO" (eco) during operation.

"ECO" will be indicated on the screen of normal mode.

The "Eco" lamp on the indoor unit lights up.

The sensor starts to detect the presence of people in the room.

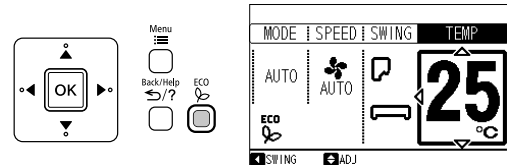

2 To cancel "Eco" operation

- Press "On/Off" (START/STOP). Or

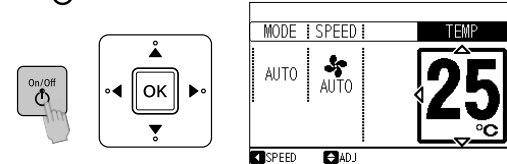

- Press "ECO" (eco) again.

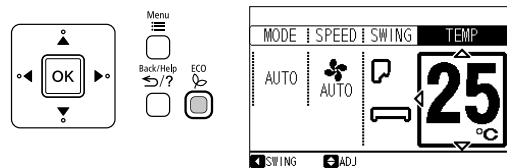

The "Eco" lamp on the indoor unit turns off.

When the presence of people is not detected for 20 minutes, the set temperature is automatically shifted for energy saving. If nobody is in the room for 60 minutes, the set temperature is shifted further.

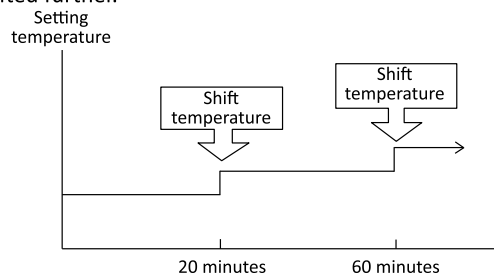

Cooling operation

[diagram representation for illustrative purpose only]

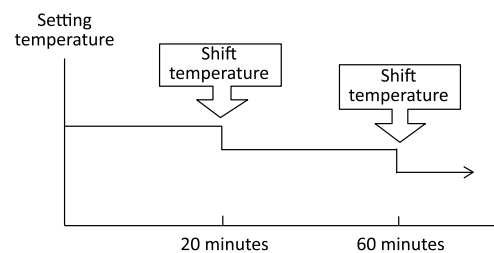

Heating operation

[diagram representation for illustrative purpose only]

The unit returns to normal operation when the sensor detects human movement.

NOTE

- Eco operation will not be effective when power consumption is low.
- After auto restart, "Eco" operation is canceled and previous operation mode shall start.

7. HELP MENU

7.1 Help menu

The explanation of indicators on LCD and operations can be found in the help menu.

The purpose of this function is to support manual operation.

1 Press "Back/Help" (return/help).

The help menu will be displayed.

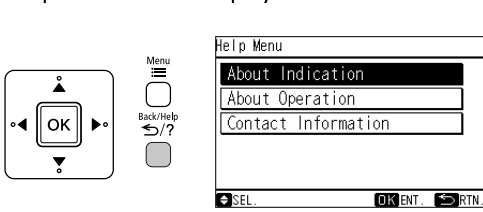

2 Select the item from the help menu by pressing "△" or "▽" and press "OK".

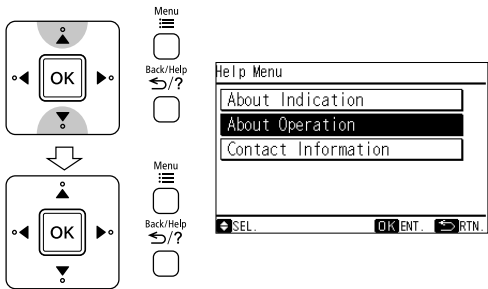

3 To return to the normal mode, press "Back/Help" (return/help).

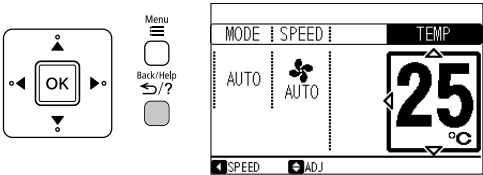

NOTE

- If the menu screen remains unchanged for approximately 10 minutes, the screen will automatically return to the normal mode.

7.2 Indication on LCD

This function is used when the explanation of each icon on LCD is required.

1 Select "About Indication" from the help menu and press "OK".
The explanation of indicators on LCD will be displayed.

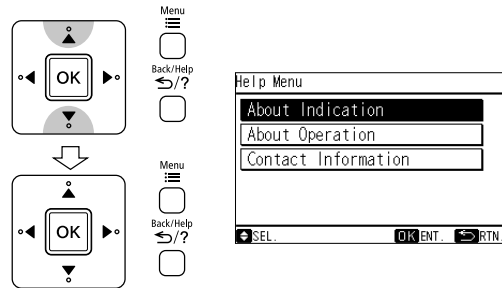

2 Press "△" or "▽" to scroll the text up and down.

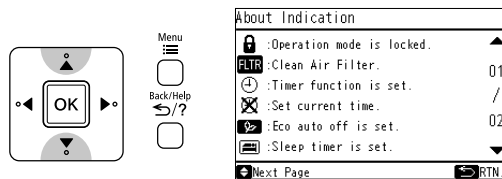

3 Press "Back/Help" (return/help). The screen will return to the help menu. To return to the normal mode, press "Back/Help" (return/help) again.

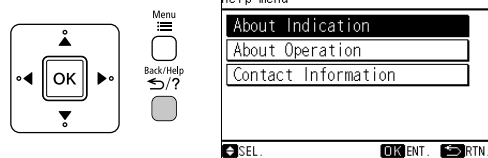

7.3 About operation

This function is used when the explanation of operations and operation methods is required.

- 1 Select "About Operation" from the help menu and press "OK". The explanation of operation list will be displayed.

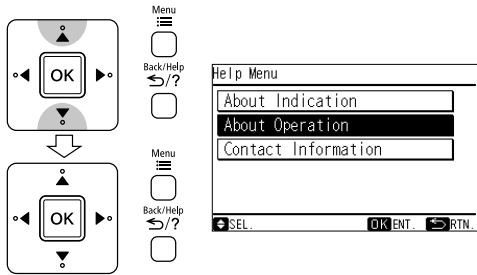

- 2 Select the operation from the list by pressing "△" or "▽" and press "OK". The explanation of the selected operation will be displayed.

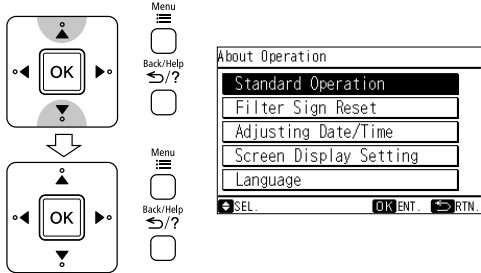

- 3 Press "△" or "▽" to scroll the text up and down.

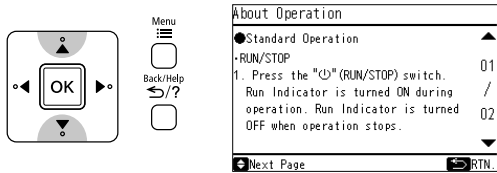

- 4 Press "Back/Help" (return/help). The screen will return to the operation item.

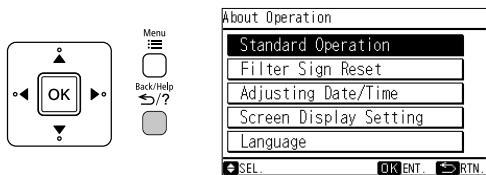

- 5 Press "Back/Help" (return/help). The screen will return to the help menu. To return to the normal mode, press "Back/Help" (return/help) again.

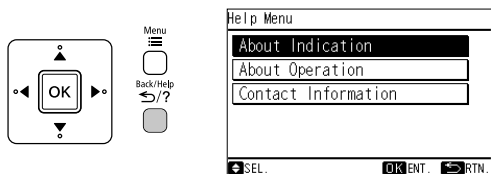

7.4 Contact information

The screen will display contact information and the latest alarm code.

- 1 Select "Contact Information" from the help menu and press "OK". The contact information and the latest alarm code will be displayed.

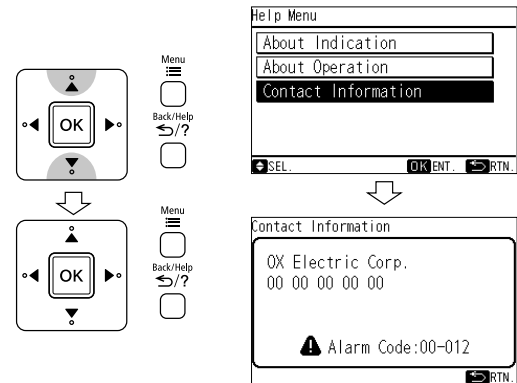

- 2 Press "Back/Help" (return/help). The screen will return to the help menu. To return to the normal mode, press "Back/Help" (return/help) again.

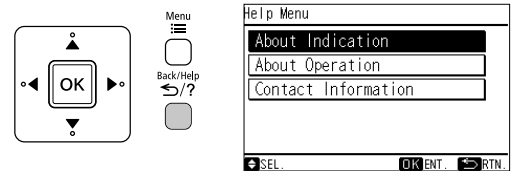

8. OTHER INDICATIONS

8.1 In normal condition

8.1.1 External device

"External device" is turned on.

In this case, the operation has been operated from external device except the remote controller.

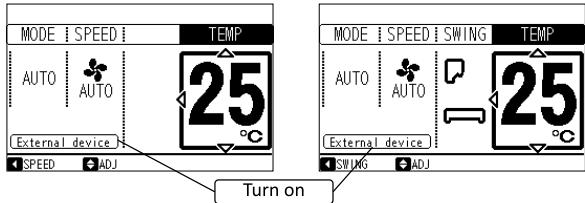

The display during stop The display during operation

"External device" will disappear when operated from the remote controller.

8.1.2 Forced Cooling

It is the operation performed by service personnel or sales agent.

"Forced Cooling" and "External device" are turned on.

It will be displayed during the forced cooling operation.

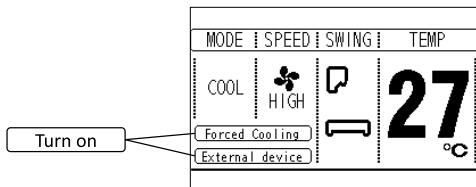

8.1.3 Eco Auto Off

It is the setting performed by service personnel or sales agent.

If "Eco Auto Off" setting is used, when "Eco" operation is started, "ECO" and "Eco Auto Off Mode" will be indicated on the screen of normal mode.

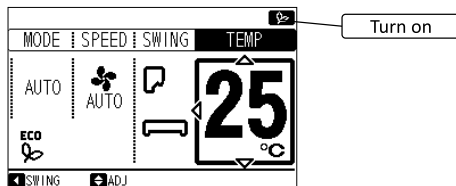

"ECO Auto Off Mode" will be indicated on the screen of normal mode when the operation is stopped by "Eco Auto Off" function

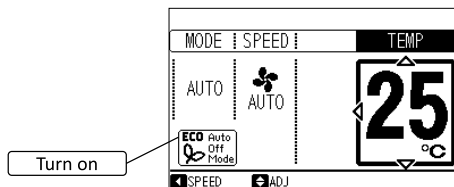

8.1.4 Key lock

It is the setting performed by service personnel or sales agent.

"Key lock" will be indicated on the screen of normal mode, and the key lock will be set.

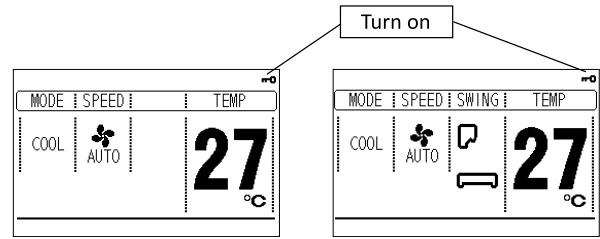

The display during stop

The display during operation

8.2 In abnormal condition

8.2.1 Communication failure

It occurs when can not communicate with this remote controller and the indoor unit.

The operation indicator (Red) is flashing and it continues to display the "Connecting" on the LCD.

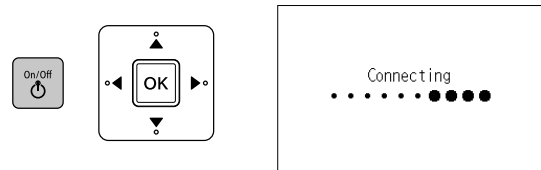

In this case, please turn off the breaker and turn on again after waiting a little.

If the failure recurs after restart, then turn off and contact your sales agent.

8.2.2 Alarm Code

The operation indicator (Red) is flashing and the alarm code is displayed on the LCD.

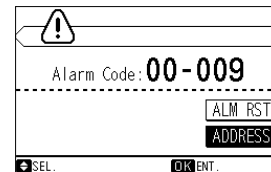

In this case, please turn off the breaker and turn on again after waiting a little.

If the failure recurs after restart, then turn off and contact your sales agent.

8.2.3 Thermistor Selection

If the followings are displayed in "Thermistor Selection" function, please contact the sales agent.

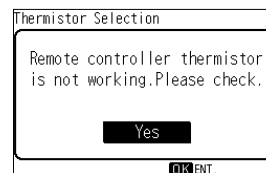

Thermistor of remote controller is not working.

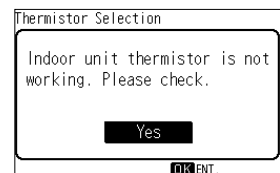

Thermistor of indoor unit is not working.

At least one thermistor is needed to ensure normal operation. If both thermistors of remote controller and indoor unit are out of order, please turn off the breaker and contact the sales agent at once.