

# PUZ-WM50VHA(-BS)

Ecodan R32

**Monobloc** Air Source Heat Pump

**R32**

## Key Features:

- A+++ high efficiency system
- Ultra quiet noise levels
- Maintains full heating capacity at low temperatures
- Zero carbon solution
- MELCloud enabled

## Key Benefits:

- Ultra low running cost
- Flexible product placement
- Confident and quick product selection
- Help to tackle the climate crisis
- Remote control, monitoring, maintenance and technical support



**ecodan**<sup>®</sup>  
Renewable Heating Technology

OUTDOOR UNIT		PUZ-WM50VHA(-BS)
HEAT PUMP SPACE HEATER - 55°C	ErP Rating	A++
	$\eta_s$	129%
	SCOP (MCS)	3.22
HEAT PUMP SPACE HEATER - 35°C	ErP Rating	A+++
	$\eta_s$	183%
	SCOP (MCS)	4.57
HEAT PUMP COMBINATION HEATER - Large Profile <sup>1</sup>	ErP Rating	A+
	$\eta_{wh}$	135%
HEATING <sup>2</sup> (A-7/W35)	Capacity (kW)	5.0
	Power Input (kW)	1.67
	COP	3.00
OPERATING AMBIENT TEMPERATURE (°C DB)		-20 ~ +35
SOUND DATA <sup>3</sup>	Pressure Level at 1m (dBA)	47
	Power Level (dBA) <sup>4</sup>	61
WATER DATA	Pipework Size (mm)	22
	Flow Rate (l/min)	14
	Water Pressure Drop (kPa)	12.0
DIMENSIONS (mm)	Width	950
	Depth	330+30 <sup>7</sup>
	Height	943
WEIGHT (kg)		71
ELECTRICAL DATA	Electrical Supply	220-240v, 50Hz
	Phase	Single
	Nominal Running Current [MAX] (A) <sup>5</sup>	4.64 [13]
	Fuse Rating - MCB Sizes (A) <sup>6</sup>	16
REFRIGERANT CHARGE (kg) / CO <sub>2</sub> EQUIVALENT (t)	R32 (GWP 675)	2.0 / 1.35

### Notes:

- \*1 Combination with E\*PT20X Cylinder
- \*2 Under normal heating conditions at outdoor temp: -7°CDB / -8°CWB, outlet water temp 35°C, inlet water temp 30°C.
- \*3 Under normal heating conditions at outdoor temp: 7°CDB / 6°CWB, outlet water temp 55°C, inlet water temp 47°C as tested to BS EN14511.
- \*4 Sound power level tested to BS EN12102.
- \*5 Under nominal heating conditions at outdoor temp: 7°C, outlet water temp: 35°C.
- \*6 MCB Sizes BS EN60898-2 & BS EN60947-2.
- \*7 Grille.

$\eta_s$  is the seasonal space heating energy efficiency (SSHEE)  $\eta_{wh}$  is the water heating energy efficiency

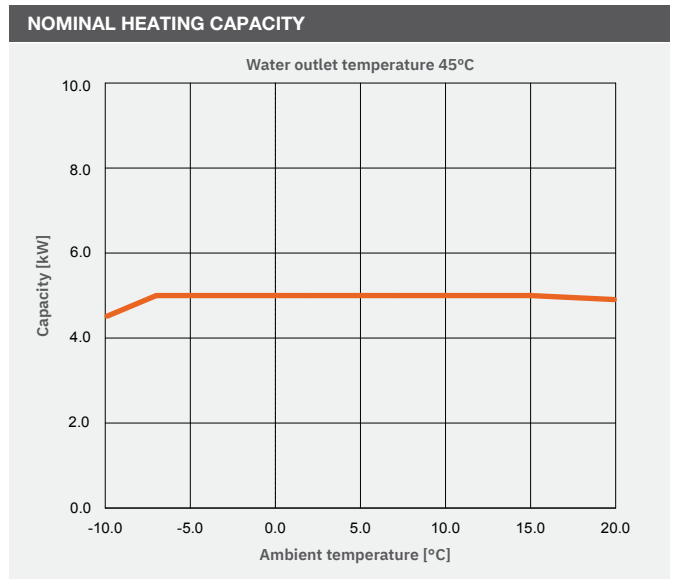

### PUZ-WM50VHA(-BS) DIMENSIONS

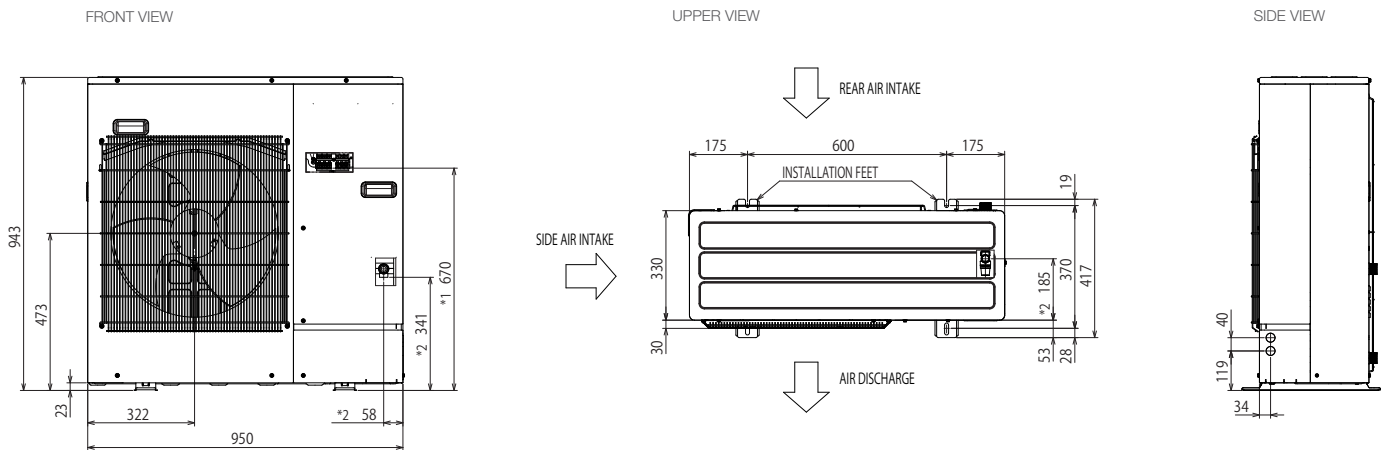

All dimensions (mm)

\*1--INDICATION OF TERMINAL CONNECTION LOCATION.  
\*2--INDICATION OF PRESSURE RELIEF VALVE DRAIN PORT.



Telephone: 01707 282880  
email: [heating@meuk.mee.com](mailto:heating@meuk.mee.com)  
[heating.mitsubishielectric.co.uk](http://heating.mitsubishielectric.co.uk)

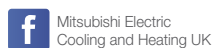

UNITED KINGDOM Mitsubishi Electric Europe Living Environment Systems Division, Travellers Lane, Hatfield, Hertfordshire, AL10 8XB, England. Telephone: 01707 282880 Fax: 01707 278881  
IRELAND Mitsubishi Electric Europe, Westgate Business Park, Ballymount, Dublin 24, Ireland. Telephone: (01) 419 8800 Fax: (01) 419 8890 International code: (003531)

Country of origin: United Kingdom - Japan - Thailand - Malaysia. ©Mitsubishi Electric Europe 2020. Mitsubishi and Mitsubishi Electric are trademarks of Mitsubishi Electric Europe B.V. The company reserves the right to make any variation in technical specification to the equipment described, or to withdraw or replace products without prior notification or public announcement. Mitsubishi Electric is constantly developing and improving its products. All descriptions, illustrations, drawings and specifications in this publication present only general particulars and shall not form part of any contract. All goods are supplied subject to the Company's General Conditions of Sale, a copy of which is available on request. Third-party product and brand names may be trademarks or registered trademarks of their respective owners.

**Note:** The fuse rating is for guidance only. Please refer to the relevant databook for detailed specification. It is the responsibility of a qualified electrician/electrical engineer to select the correct cable size and fuse rating based on current regulation and site specific conditions. Mitsubishi Electric's air conditioning equipment and heat pump systems contain a fluorinated greenhouse gas, R410A (GWP:2088), R32 (GWP:675), R407C (GWP:1774), R134a (GWP:1430), R513A (GWP:631), R454B (GWP:466), R1234ze (GWP:7) or R1234yf (GWP:4). \*These GWP values are based on Regulation (EU) No 517/2014 from IPCC 4th edition. In case of Regulation (EU) No.626/2011 from IPCC 3rd edition, these are as follows. R410A (GWP:1975), R32 (GWP:550), R407C (GWP:1650) or R134a (GWP:1300).

Effective as of August 2020



# PUZ-WM60VAA(-BS)

Ecodan R32

**Monobloc** Air Source Heat Pump



## Key Features:

- A+++ high efficiency system
- Ultra quiet noise levels
- Maintains full heating capacity at low temperatures
- Zero carbon solution
- MELCloud enabled

## Key Benefits:

- Ultra low running cost
- Flexible product placement
- Confident and quick product selection
- Help to tackle the climate crisis
- Remote control, monitoring, maintenance and technical support



Manufactured in the UK

037-0033-20-01

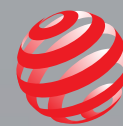

**ecodan**<sup>®</sup>  
Renewable Heating Technology

OUTDOOR UNIT		PUZ-WM60VAA(-BS)
HEAT PUMP SPACE HEATER - 55°C	ErP Rating	A++
	$\eta_s$	142%
	SCOP (MCS)	3.56
HEAT PUMP SPACE HEATER - 35°C	ErP Rating	A+++
	$\eta_s$	190%
	SCOP (MCS)	4.76
HEAT PUMP COMBINATION HEATER - Large Profile <sup>1</sup>	ErP Rating	A+
	$\eta_{wh}$	145%
HEATING <sup>2</sup> (A-7/W35)	Capacity (kW)	6.0
	Power Input (kW)	1.88
	COP	3.20
OPERATING AMBIENT TEMPERATURE (°C DB)		-20 ~ +35
SOUND DATA <sup>3</sup>	Pressure Level at 1m (dBA)	45
	Power Level (dBA) <sup>4</sup>	58
	Pipework Size (mm)	22
WATER DATA	Flow Rate (l/min)	17
	Water Pressure Drop (kPa)	8.0
	DIMENSIONS (mm)	Width
	Depth	480
	Height	1020
WEIGHT (kg)		98
ELECTRICAL DATA	Electrical Supply	220-240v, 50Hz
	Phase	Single
	Nominal Running Current [MAX] (A) <sup>5</sup>	5.68 [13]
	Fuse Rating - MCB Sizes (A) <sup>6</sup>	16
REFRIGERANT CHARGE (kg) / CO <sub>2</sub> EQUIVALENT (t)	R32 (GWP 675)	2.2 / 1.49

### Notes:

- <sup>1</sup> Combination with E\*PT20X Cylinder
- <sup>2</sup> Under normal heating conditions at outdoor temp: -7°CDB / -8°CWB, outlet water temp 35°C, inlet water temp 30°C.
- <sup>3</sup> Under normal heating conditions at outdoor temp: 7°CDB / 6°CWB, outlet water temp 55°C, inlet water temp 47°C as tested to BS EN14511.
- <sup>4</sup> Sound power level tested to BS EN12102.
- <sup>5</sup> Under nominal heating conditions at outdoor temp: 7°C, outlet water temp: 35°C.
- <sup>6</sup> MCB Sizes BS EN60898-2 & BS EN60947-2.

$\eta_s$  is the seasonal space heating energy efficiency (SSHEE)  $\eta_{wh}$  is the water heating energy efficiency

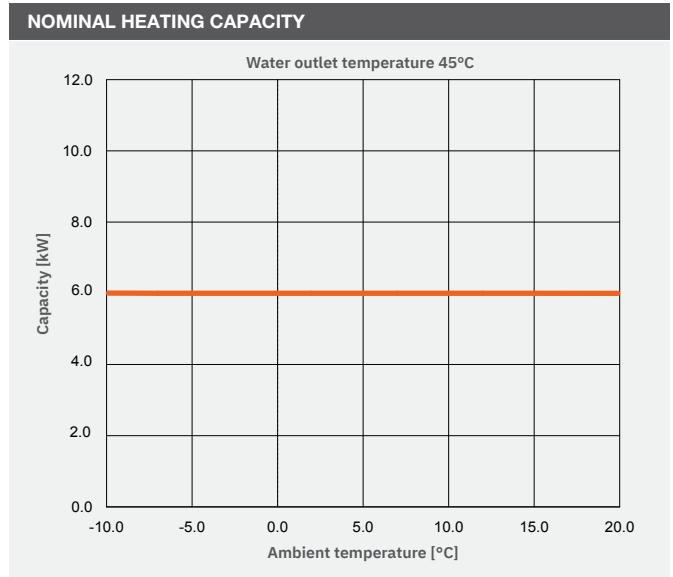

### PUZ-WM60VAA(-BS) DIMENSIONS

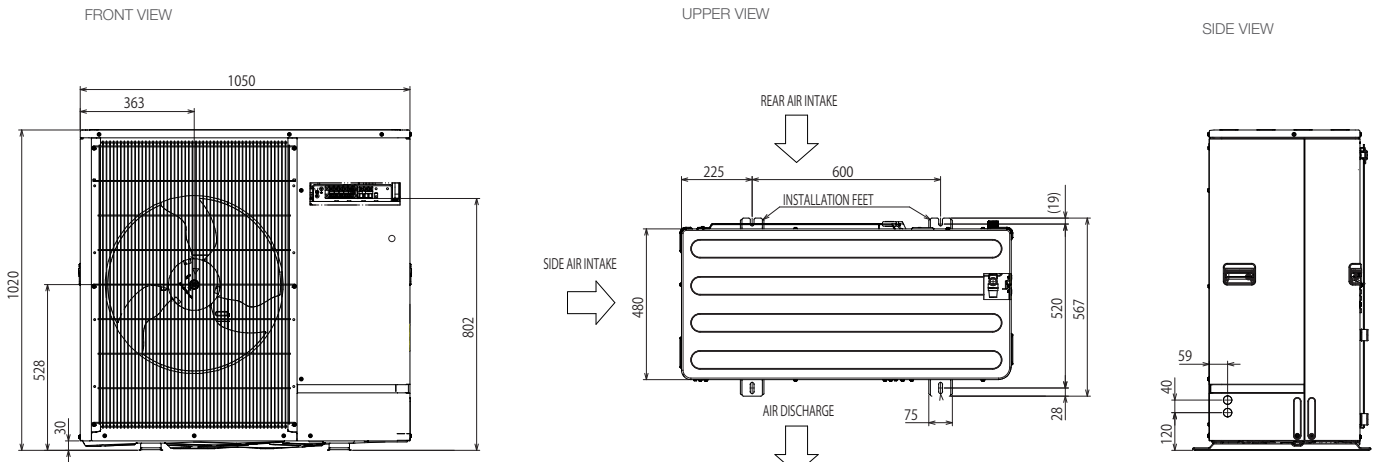

All dimensions (mm)



Telephone: 01707 282880  
email: [heating@meuk.mee.com](mailto:heating@meuk.mee.com)  
[heating.mitsubishielectric.co.uk](http://heating.mitsubishielectric.co.uk)

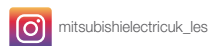
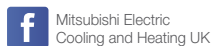

UNITED KINGDOM Mitsubishi Electric Europe Living Environment Systems Division, Travellers Lane, Hatfield, Hertfordshire, AL10 8XB, England. Telephone: 01707 282880 Fax: 01707 278881  
IRELAND Mitsubishi Electric Europe, Westgate Business Park, Ballymount, Dublin 24, Ireland. Telephone: (01) 419 8800 Fax: (01) 419 8890 International code: (003531)

Country of origin: United Kingdom - Japan - Thailand - Malaysia. ©Mitsubishi Electric Europe 2020. Mitsubishi and Mitsubishi Electric are trademarks of Mitsubishi Electric Europe B.V. The company reserves the right to make any variation in technical specification to the equipment described, or to withdraw or replace products without prior notification or public announcement. Mitsubishi Electric is constantly developing and improving its products. All descriptions, illustrations, drawings and specifications in this publication present only general particulars and shall not form part of any contract. All goods are supplied subject to the Company's General Conditions of Sale, a copy of which is available on request. Third-party product and brand names may be trademarks or registered trademarks of their respective owners.

**Note:** The fuse rating is for guidance only. Please refer to the relevant databook for detailed specification. It is the responsibility of a qualified electrician/electrical engineer to select the correct cable size and fuse rating based on current regulation and site specific conditions. Mitsubishi Electric's air conditioning equipment and heat pump systems contain a fluorinated greenhouse gas, R410A (GWP:2088), R32 (GWP:675), R407C (GWP:1774), R134a (GWP:1430), R513A (GWP:631), R454B (GWP:466), R1234ze (GWP:7) or R1234yf (GWP:4). \*These GWP values are based on Regulation (EU) No 517/2014 from IPCC 4th edition. In case of Regulation (EU) No.626/2011 from IPCC 3rd edition, these are as follows. R410A (GWP:1975), R32 (GWP:550), R407C (GWP:1650) or R134a (GWP:1300).

Effective as of August 2020



# PUZ-WM85VAA(-BS)

Ecodan R32

**Monobloc** Air Source Heat Pump

**R32**

## Key Features:

- A+++ high efficiency system
- Ultra quiet noise levels
- Maintains full heating capacity at low temperatures
- Zero carbon solution
- MELCloud enabled

## Key Benefits:

- Ultra low running cost
- Flexible product placement
- Confident and quick product selection
- Help to tackle the climate crisis
- Remote control, monitoring, maintenance and technical support



Manufactured in the UK



037-0033-20-03

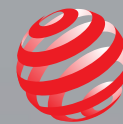

**ecodan**<sup>®</sup>  
Renewable Heating Technology

OUTDOOR UNIT		PUZ-WM85VAA(-BS)
HEAT PUMP SPACE HEATER - 55°C	ErP Rating	A++
	$\eta_s$	139%
	SCOP (MCS)	3.47
HEAT PUMP SPACE HEATER - 35°C	ErP Rating	A+++
	$\eta_s$	193%
	SCOP (MCS)	4.79
HEAT PUMP COMBINATION HEATER - Large Profile <sup>1</sup>	ErP Rating	A+
	$\eta_{wh}$	145%
HEATING <sup>2</sup> (A-7/W35)	Capacity (kW)	8.5
	Power Input (kW)	3.27
	COP	2.60
OPERATING AMBIENT TEMPERATURE (°C DB)		-20 ~ +35
SOUND DATA <sup>3</sup>	Pressure Level at 1m (dBA)	45
	Power Level (dBA) <sup>4</sup>	58
WATER DATA	Pipework Size (mm)	28
	Flow Rate (l/min)	24
	Water Pressure Drop (kPa)	15.0
DIMENSIONS (mm)	Width	1050
	Depth	480
	Height	1020
WEIGHT (kg)		98
ELECTRICAL DATA	Electrical Supply	220-240v, 50Hz
	Phase	Single
	Nominal Running Current [MAX] (A) <sup>5</sup>	9.1 [22]
	Fuse Rating - MCB Sizes (A) <sup>6</sup>	25
REFRIGERANT CHARGE (kg) / CO <sub>2</sub> EQUIVALENT (t)	R32 (GWP 675)	2.2 / 1.49

**Notes:**

- <sup>1</sup> Combination with E\*PT20X Cylinder
  - <sup>2</sup> Under normal heating conditions at outdoor temp: -7°CDB / -8°CWB, outlet water temp 35°C, inlet water temp 30°C.
  - <sup>3</sup> Under normal heating conditions at outdoor temp: 7°CDB / 6°CWB, outlet water temp 55°C, inlet water temp 47°C as tested to BS EN14511.
  - <sup>4</sup> Sound power level tested to BS EN12102.
  - <sup>5</sup> Under nominal heating conditions at outdoor temp: 7°C, outlet water temp: 35°C.
  - <sup>6</sup> MCB Sizes BS EN60898-2 & BS EN60947-2.
- $\eta_s$  is the seasonal space heating energy efficiency (SSHEE)  $\eta_{wh}$  is the water heating energy efficiency

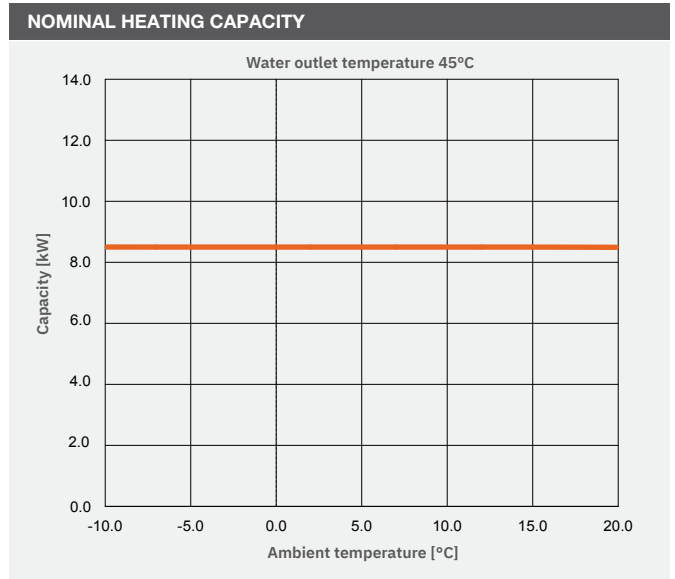

### PUZ-WM85VAA(-BS) DIMENSIONS

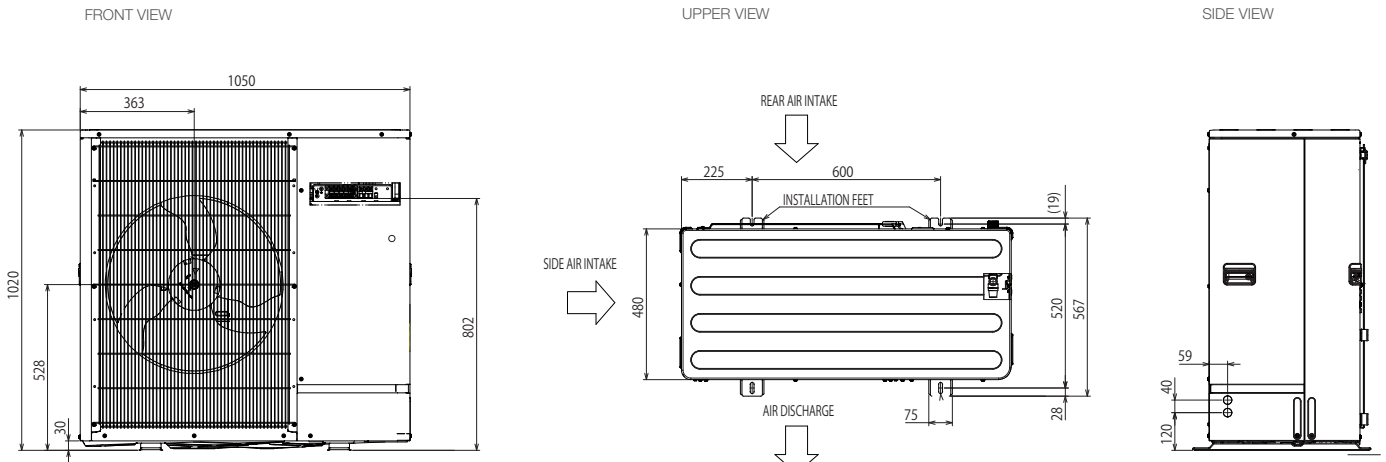

All dimensions (mm)

**MITSUBISHI ELECTRIC**  
Changes for the Better

Telephone: 01707 282880  
email: [heating@meuk.mee.com](mailto:heating@meuk.mee.com)  
[heating.mitsubishielectric.co.uk](http://heating.mitsubishielectric.co.uk)

[@meuk\\_les](https://twitter.com/meuk_les) | 
 [in](https://www.linkedin.com/company/mitsubishi-electric-living-environmental-systems-uk) Mitsubishi Electric Living Environmental Systems UK | 
 [f](https://www.facebook.com/mitsubishielectricuk) Mitsubishi Electric Cooling and Heating UK | 
 [ig](https://www.instagram.com/mitsubishielectricuk_les) mitsubishielectricuk\_les | 
 [yt](https://www.youtube.com/channel/UC...) Mitsubishi Electric Living Environmental Systems UK | 
 [BLOG](https://www.blog.mitsubishielectric.co.uk) thehub.mitsubishielectric.co.uk

UNITED KINGDOM Mitsubishi Electric Europe Living Environment Systems Division, Travellers Lane, Hatfield, Hertfordshire, AL10 8XB, England. Telephone: 01707 282880 Fax: 01707 278881  
IRELAND Mitsubishi Electric Europe, Westgate Business Park, Ballymount, Dublin 24, Ireland. Telephone: (01) 419 8800 Fax: (01) 419 8890 International code: (003531)

Country of origin: United Kingdom - Japan - Thailand - Malaysia. ©Mitsubishi Electric Europe 2020. Mitsubishi and Mitsubishi Electric are trademarks of Mitsubishi Electric Europe B.V. The company reserves the right to make any variation in technical specification to the equipment described, or to withdraw or replace products without prior notification or public announcement. Mitsubishi Electric is constantly developing and improving its products. All descriptions, illustrations, drawings and specifications in this publication present only general particulars and shall not form part of any contract. All goods are supplied subject to the Company's General Conditions of Sale, a copy of which is available on request. Third-party product and brand names may be trademarks or registered trademarks of their respective owners.

**Note:** The fuse rating is for guidance only. Please refer to the relevant databook for detailed specification. It is the responsibility of a qualified electrician/electrical engineer to select the correct cable size and fuse rating based on current regulation and site specific conditions. Mitsubishi Electric's air conditioning equipment and heat pump systems contain a fluorinated greenhouse gas, R410A (GWP:2088), R32 (GWP:675), R407C (GWP:1774), R134a (GWP:1430), R513A (GWP:631), R454B (GWP:466), R1234ze (GWP:7) or R1234yf (GWP:4). \*These GWP values are based on Regulation (EU) No 517/2014 from IPCC 4th edition. In case of Regulation (EU) No.626/2011 from IPCC 3rd edition, these are as follows. R410A (GWP:1975), R32 (GWP:550), R407C (GWP:1650) or R134a (GWP:1300).

Effective as of August 2020



**Green Gateway** [greengateway.mitsubishielectric.co.uk](http://greengateway.mitsubishielectric.co.uk)

# PUZ-WM112VAA(-BS)

Ecodan R32

**Monobloc** Air Source Heat Pump

**R32**

## Key Features:

- A+++ high efficiency system
- Ultra quiet noise levels
- Maintains full heating capacity at low temperatures
- Zero carbon solution
- MELCloud enabled

## Key Benefits:

- Ultra low running cost
- Flexible product placement
- Confident and quick product selection
- Help to tackle the climate crisis
- Remote control, monitoring, maintenance and technical support



Manufactured in the UK



037-0034-20-01

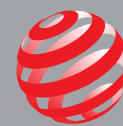

**ecodan**<sup>®</sup>  
Renewable Heating Technology

OUTDOOR UNIT		PUZ-WM112VAA(-BS)
HEAT PUMP SPACE HEATER - 55°C	ErP Rating	A++
	$\eta_s$	134%
	SCOP (MCS)	3.34
HEAT PUMP SPACE HEATER - 35°C	ErP Rating	A+++
	$\eta_s$	191%
	SCOP (MCS)	4.78
HEAT PUMP COMBINATION HEATER - Large Profile <sup>1</sup>	ErP Rating	A+
	$\eta_{wh}$	148%
HEATING <sup>2</sup> (A-7/W35)	Capacity (kW)	11.2
	Power Input (kW)	3.73
	COP	3.00
OPERATING AMBIENT TEMPERATURE (°C DB)		-25 ~ +35
SOUND DATA <sup>3</sup>	Pressure Level at 1m (dBA)	45
	Power Level (dBA) <sup>4</sup>	60
WATER DATA	Pipework Size (mm)	28
	Flow Rate (l/min)	32
	Water Pressure Drop (kPa)	24.0
DIMENSIONS (mm)	Width	1050
	Depth	480
	Height	1020
WEIGHT (kg)		119
ELECTRICAL DATA	Electrical Supply	220-240v, 50Hz
	Phase	Single
	Nominal Running Current [MAX] (A) <sup>5</sup>	10.9 [28]
	Fuse Rating - MCB Sizes (A) <sup>6</sup>	32
REFRIGERANT CHARGE (kg) / CO <sub>2</sub> EQUIVALENT (t)	R32 (GWP 675)	3.0 / 2.03

### Notes:

- \*1 Combination with E\*PT20X Cylinder
  - \*2 Under normal heating conditions at outdoor temp: -7°CDB / -8°CWB, outlet water temp 35°C, inlet water temp 30°C.
  - \*3 Under normal heating conditions at outdoor temp: 7°CDB / 6°CWB, outlet water temp 55°C, inlet water temp 47°C as tested to BS EN14511.
  - \*4 Sound power level tested to BS EN12102.
  - \*5 Under nominal heating conditions at outdoor temp: 7°C, outlet water temp: 35°C.
  - \*6 MCB Sizes BS EN60898-2 & BS EN60947-2.
- $\eta_s$  is the seasonal space heating energy efficiency (SSHEE)  $\eta_{wh}$  is the water heating energy efficiency

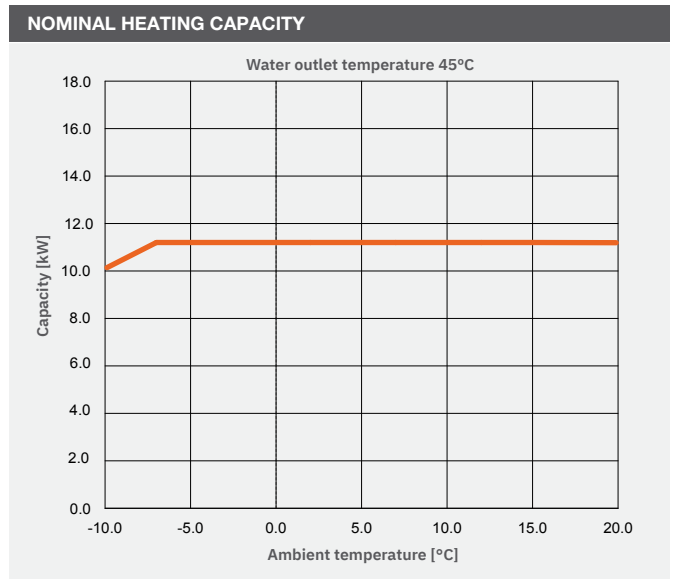

### PUZ-WM112VAA(-BS) DIMENSIONS

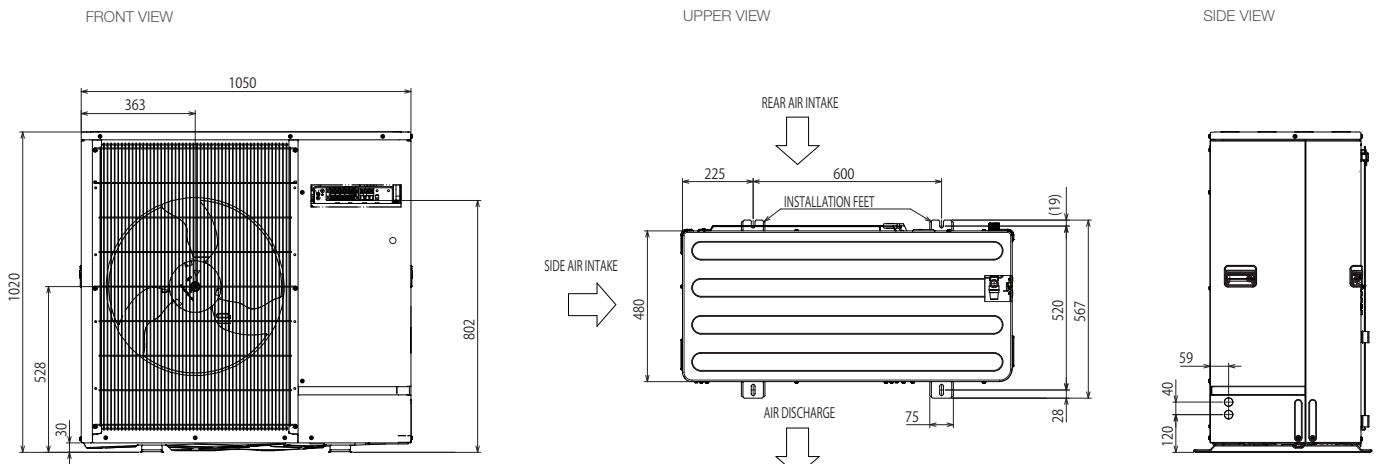

All dimensions (mm)

**MITSUBISHI ELECTRIC**  
Changes for the Better

Telephone: 01707 282880  
email: [heating@meuk.mee.com](mailto:heating@meuk.mee.com)  
[heating.mitsubishielectric.co.uk](http://heating.mitsubishielectric.co.uk)

[@meuk\\_les](https://twitter.com/meuk_les) | 
 [in](https://www.linkedin.com/company/mitsubishi-electric-living-environmental-systems-uk) Mitsubishi Electric Living Environmental Systems UK | 
 [f](https://www.facebook.com/mitsubishielectricuk_les) Mitsubishi Electric Cooling and Heating UK | 
 [ig](https://www.instagram.com/mitsubishielectricuk_les) mitsubishielectricuk\_les | 
 [yt](https://www.youtube.com/channel/UC...) Mitsubishi Electric Living Environmental Systems UK | 
 [BLOG](https://www.blog.mitsubishielectric.co.uk) thehub.mitsubishielectric.co.uk

UNITED KINGDOM Mitsubishi Electric Europe Living Environment Systems Division, Travellers Lane, Hatfield, Hertfordshire, AL10 8XB, England. Telephone: 01707 282880 Fax: 01707 278881  
IRELAND Mitsubishi Electric Europe, Westgate Business Park, Ballymount, Dublin 24, Ireland. Telephone: (01) 419 8800 Fax: (01) 419 8890 International code: (003531)

Country of origin: United Kingdom - Japan - Thailand - Malaysia. ©Mitsubishi Electric Europe 2020. Mitsubishi and Mitsubishi Electric are trademarks of Mitsubishi Electric Europe B.V. The company reserves the right to make any variation in technical specification to the equipment described, or to withdraw or replace products without prior notification or public announcement. Mitsubishi Electric is constantly developing and improving its products. All descriptions, illustrations, drawings and specifications in this publication present only general particulars and shall not form part of any contract. All goods are supplied subject to the Company's General Conditions of Sale, a copy of which is available on request. Third-party product and brand names may be trademarks or registered trademarks of their respective owners.

**Note:** The fuse rating is for guidance only. Please refer to the relevant databook for detailed specification. It is the responsibility of a qualified electrician/electrical engineer to select the correct cable size and fuse rating based on current regulation and site specific conditions. Mitsubishi Electric's air conditioning equipment and heat pump systems contain a fluorinated greenhouse gas, R410A (GWP:2088), R32 (GWP:675), R407C (GWP:1774), R134a (GWP:1430), R513A (GWP:631), R454B (GWP:466), R1234ze (GWP:7) or R1234yf (GWP:4). \*These GWP values are based on Regulation (EU) No 517/2014 from IPCC 4th edition. In case of Regulation (EU) No.626/2011 from IPCC 3rd edition, these are as follows. R410A (GWP:1975), R32 (GWP:550), R407C (GWP:1650) or R134a (GWP:1300).

Effective as of August 2020

