

Outdoor Type Refrigeration Unit (Non-fluorocarbon Refrigeration Unit with CO₂ Refrigerant)

Operating Instructions and Installation Instructions

Model No. OCU-CR1000VF8A / OCU-CR1000VF8ASL

Thank you very much for purchasing Panasonic products this time.
Please read this instruction booklet and correctly comply with the explanations.
In particular, please read "Cautions for Safety" (Pages EN2 to EN8) for ensuring safe operations.
Please retain this instruction booklet in a safe place.



Caution labels are attached to the product.

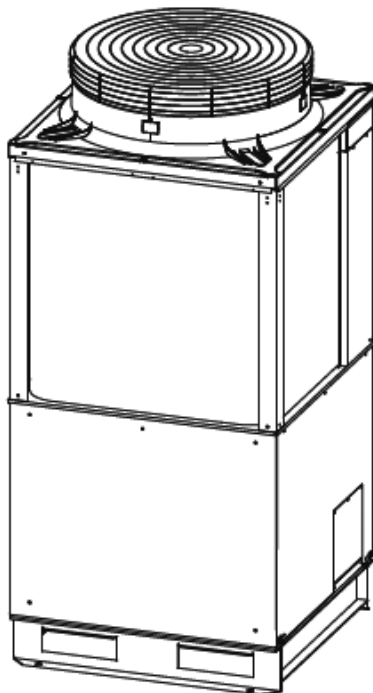

This illustration represents OCU-CR1000VF8A
Electrical Approval Certificate in Australia
CS10836N

CONTENTS

Cautions for Safety.....	2-8
Name of Each Part.....	9
Scope of Application, Specifications.....	10-11
For Effectively Using the Refrigeration Unit.....	12-13
Selection of Installation Location.....	13-14
Carry-in/Installation.....	14-15
Installation Example.....	16
Refrigerant Piping Work.....	17-18
Piping Example.....	19
Refrigerant Circuit Diagram.....	20
Refrigerant Charging.....	21-22
Cautions for Electrical Wiring Work.....	23
Electrical Wiring Work.....	24-25
Electrical Circuit Diagram.....	26-27
What Needs to be Checked before Operation.....	28
Setting and Indication.....	29-33
Control Functions.....	34-36
Adjustment during Operation.....	36-37
Oil Level Control Method.....	38-41
About Alarms.....	41-43
Maintenance and Inspection.....	44
Actions at the time of Failure.....	45-46
Failure Diagnosis.....	47-53
Makings for Directive 2014/68/EU (PED).....	54



NOTICE • The English text is the original instructions.
Other languages are translation of the original instructions.

Cautions for Safety



(Be sure to comply with the following)

For the purpose of avoiding harm to people and damage to properties, items to be complied with are explained here.

- Explanations are classified by degree of harm or damage caused by incorrect use.





 WARNING	Indicates possibility of death or serious injury.
 CAUTION	Indicates possibility of minor injury or damage to properties.

- Items to be observed are explained by the following pictograms.

	Indicates what you should not do.
	Indicates what you must do.

WARNING





Installation Work

<p>Installation to be made by manufacturer's service personnel or similarly skilled person.</p> <p> Incorrect installation work may lead to malfunction such as abnormal vibration, and generates refrigerant gas leak, electrical shock, or fire.</p>	<p>Do not use other than the designated refrigerant (for charging, adding or recharging)</p> <p> Non-designated refrigerant may cause equipment failure or burst, or injury.</p>
<p>Appliances employing R744 refrigeration system.</p> <p> System contains refrigerant under high pressure. Do not tamper with the system. It must be serviced by qualified persons only.</p> <p>⇨R744⇩</p>	<p>Securely complete refrigerant piping before carrying out airtight testing.</p> <p> Refrigerant gas leak may cause suffocation.</p>





Cautions for Safety

(Be sure to comply with the following)

Installation Work

<p>Installation should be made securely on a place that can fully support the mass of the refrigeration unit.</p> <p> Insufficient foundation may cause falling or dropping, and lead to refrigerant gas leak, injury, electrical shock, or fire.</p> <ul style="list-style-type: none"> • Refrigeration unit should be secured on a concrete base with a mass approximately 3 times that of the unit and fastened with anchor bolts. 	<p>Perform airtight test before charging refrigerant.</p> <p> Refrigerant gas leak may cause insufficient oxygen and lead to a death accident.</p> <ul style="list-style-type: none"> • Carry out airtight test and confirm no leak of refrigerant.
<p>Install the safety cover.</p> <p> Touching the refrigeration unit by hand of the people other than the designated operators may cause injury.</p> <ul style="list-style-type: none"> • Install a safety cover or protective fence. 	<p>Piping, equipment components and tools should be exclusively for R744 (CO₂ refrigerant).</p> <p> Use of components for HFC refrigerant may cause serious accidents such as equipment failure and rupture of the refrigerant cycle.</p>









Electrical Work

<p>Always use a dedicated circuit and install a ground fault protector.</p> <p> Incorrect electrical work may lead to current leak and fire or electrical shock.</p> <ul style="list-style-type: none"> • Wiring work should conform to the installation instructions. 	<p>Grounding Work</p> <p> Lack of grounding work may lead to electrical shock caused by current leak.</p> <ul style="list-style-type: none"> • Securely carry out grounding work by qualified technicians.
<p>Electrical wiring should use the specified cable and to be properly secured.</p> <p> When the specified cable is not used, or connection or securing is incomplete, electrical resistance becomes larger and may cause abnormal heating or fire.</p> <ul style="list-style-type: none"> • Use the specified cable and properly secure it on an appropriate location. 	<p>Securely place the cover on the electrical box and enclosure panel.</p> <p> Incomplete attachment may lead to penetration of water and living creatures, thereby causing current leak and fire/electrical shock.</p> <ul style="list-style-type: none"> • Confirm that covers are securely installed.

Cautions for Safety

(Be sure to comply with the following)

Cautions for Use

<p>Do not change the set values of the safety device.</p>  <p>Using the refrigeration unit with changed values may cause failure of the safety stop function and lead to a burst or fire.</p> <ul style="list-style-type: none"> Do not change the set values of the safety device. If they are changed unintentionally, shut off the power switch and ground fault protector and consult with the distributor. 	<p>Do not insert a finger, stick or foreign object into the ventilation opening and fan guard of the enclosure panel.</p>  <p>Such object may hit the fast rotating fan and result in injury.</p>
<p>When the ground fault protector activates, report to the specialty company.</p>  <p>Forced recovery of power may cause current leak, leading to fire or electrical shock.</p>	<p>When water or other material gets into the electrical box, turn off the power switch and shut off the ground fault protector.</p>  <p>Continued use may cause short-circuit, leading to fire or electrical shock.</p> <ul style="list-style-type: none"> Do not splash water on electrical components or wash them with water.
<p>For the purpose of controlling concentration of refrigerant gas, install a leak detector and mechanical ventilation equipment in the refrigerant-handling facility (inside the room).</p>  <p>Refrigerant gas leak may cause suffocation.</p>	<p>Restriction on use of equipment</p>  <p>The appliance is not to be used by persons (including children) with reduced physical, sensory or mental capabilities, or lack of experience and knowledge, unless they have been given supervision or instruction.</p>
<p>Consideration for children</p>  <p>Children shall not play with the appliance. «In the European Market» Children should be supervised to ensure that they do not play with the appliance. «In the Australian and New Zealand market»</p>	<p>Restriction on use of equipment</p>  <p>This appliance can be used by children aged from 8 years and above and persons with reduced physical, sensory or mental capabilities or lack of experience and knowledge if they have been given supervision or instruction concerning use of the appliance in a safe way and understand the hazards involved. «In the European Market»</p>
<p>Cleaning and maintenance by trained person.</p>  <p>Cleaning and user maintenance shall not be made by children without supervision. «In the European Market»</p>	

Cautions for Safety

(Be sure to comply with the following)

Cautions for Use

Restriction on use of equipment



This appliance is not intended for use by persons (including children) with reduced physical, sensory or mental capabilities, or lack of experience and knowledge, unless they have been given supervision or instruction concerning use of the appliance by a person responsible for their safety.

«In the Australian and New Zealand market»

Repairs

Disassembly or repairs should be performed by a specialty operator.



Incorrect disassembly or repair may lead to abnormal operation and causes injury, fire or electrical shock.

- Request a specialty operator to perform disassembly or repair work.
Do not absolutely perform modification.

When abnormal operation was detected, or before starting disassembly or repair, turn off the power switch and shut off the ground fault protector.



Continued operation with abnormal condition, or disassembly/repair without shutting off the power would lead to current leak or short-circuit and may cause fire or electrical shock.

Specified components must be used for repair.



Use of non-specified components may cause failure of the safety stop function and lead to burst or fire.

- Consult with the distributor.

Stop the compressor before disconnecting the refrigerant piping.



Disconnecting the piping while the compressor is in operation would cause abnormally high pressure with air intake, and may lead to a burst or injury.

Replacing the power cord.



If the supply cord is damaged, it must be replaced by manufacturer, its service agent or similarly qualified persons in order to avoid a hazard.

Contact technician.



If any leak of refrigerant is detected, contact the authorized, licensed and qualified technician to repair the system.

Moving or Change of Installation Location

Request a certified installer for moving or changing the location.



Incorrect installation or moving work may lead to malfunction such as abnormal vibration, and generates refrigerant gas leak, electrical shock, or fire.

Cautions for Safety

(Be sure to comply with the following)

CAUTION

Installation Work

Do not install in a place with possible leak of flammable gas.



Leaked flammable gas around the refrigeration unit may catch fire from a spark of a switch and lead to fire.

Produce a refrigeration cycle within the limits of an operation standard (Scope of Application).



Non-standard refrigeration cycle may generate abnormal high pressure and abnormal heat generation, thereby causing burst, smoke generation, fire and current leak.

Apply a drain work according to the need.



Without consideration of drain water processing, moisture from rainwater and defrosted water generates mold and moss, and may cause slipping on the floor.

Apply heat insulation on the suction line and liquid line.



Lack of heat insulation generates water from condensation and mold and moss, thus causing slipping on the floor.

Install in a place without air stagnation.



Leak of refrigerant gas may cause insufficient oxygen and harm human health.

- Install in a place with good ventilation.

Request a specialty operator for moving the refrigeration unit.



Incorrect moving may cause falling or dropping of the refrigeration unit, and cause injury.

- Refrigeration unit is a heavy item. Always consult with a specialty operator.

Electrical Work

Always install a ground fault protector with the specified capacity.



Incorrect capacity does not operate safety stop function and may lead to fire or electrical shock.

Ground fault protector needs to follow IEC60364-4-44 443, overvoltage category III. (Impulse withstand voltage value 4kV.)

Do not include electrical wiring in the heat insulation material.



Condensation of piping may cause current leak and fire caused by overheating.

Cautions for Safety

(Be sure to comply with the following)

This product is intended for professional use.



Permission from the power supplier is required when you connect this unit to a 16A distribution network.

Cautions for Use

When the refrigerant bursts out, shut off the power and fully close the service valve.



Blowout of refrigerant from the refrigeration cycle by opening the service port would cause insufficient oxygen and harm human health.

Do not use flammable spray near the refrigeration unit. Do not place flammable materials nearby.



Flammable material may catch fire from switch spark.

Do not touch electrical components by a wet hand.



Switching operation by a wet hand may cause electrical shock and injury.

Before any inspection service, turn off the power switch and shut down the ground fault protector.



Inspection work with power on may lead to electrical shock, interference with the moving mechanism, and heat generation, thereby leading to injury and skin burn.

Periodically check operation of the ground fault protector.



Failed interrupter does not operate safety stop function and may lead to fire or electrical shock.

Do not touch the fin of the gas cooler.



Touching the fin and sliding along the fin may cause skin cut by the fin edge.

Do not ride on the refrigeration unit.



Riding on the refrigeration unit or placing an article on it may lead to falling or dropping by vibration and cause injury.

Do not operate with the oil service valve closed.



Operation with the oil service valve closed would cause an error.

Periodically check the installed base.



Damaged base after a long-time use may cause the refrigeration unit to fall or drop and lead to injury.

Emergency (Leakage, Fire or Explosion).



Do not attempt to operate or repair the unit during emergencies if it is not safe to do so.

Cautions for Safety

(Be sure to comply with the following)

Disposal

Request a specialty operator for disposing the refrigeration unit.



The refrigeration system is under high pressure. Disposal with the refrigerant and oil inside the refrigeration unit may cause fire or explosion.

Before disposal



The refrigeration system is under high pressure. Do not tamper with it. Contact qualified service personal before disposal.

Disposal of Old Equipment

Only for European Union and countries with recycling systems



This symbol on the products, packaging, and/or accompanying documents means that used electrical and electronic products must not be mixed with general household waste.



For proper treatment, recovery and recycling of old products, please take them to applicable collection points in accordance with your national legislation.

By disposing of them correctly, you will help to save valuable resources and prevent any potential negative effects on human health and the environment.

For more information about collection and recycling, please contact your local authority.

Penalties may be applicable for incorrect disposal of this waste, in accordance with national legislation.

Name of Each Part

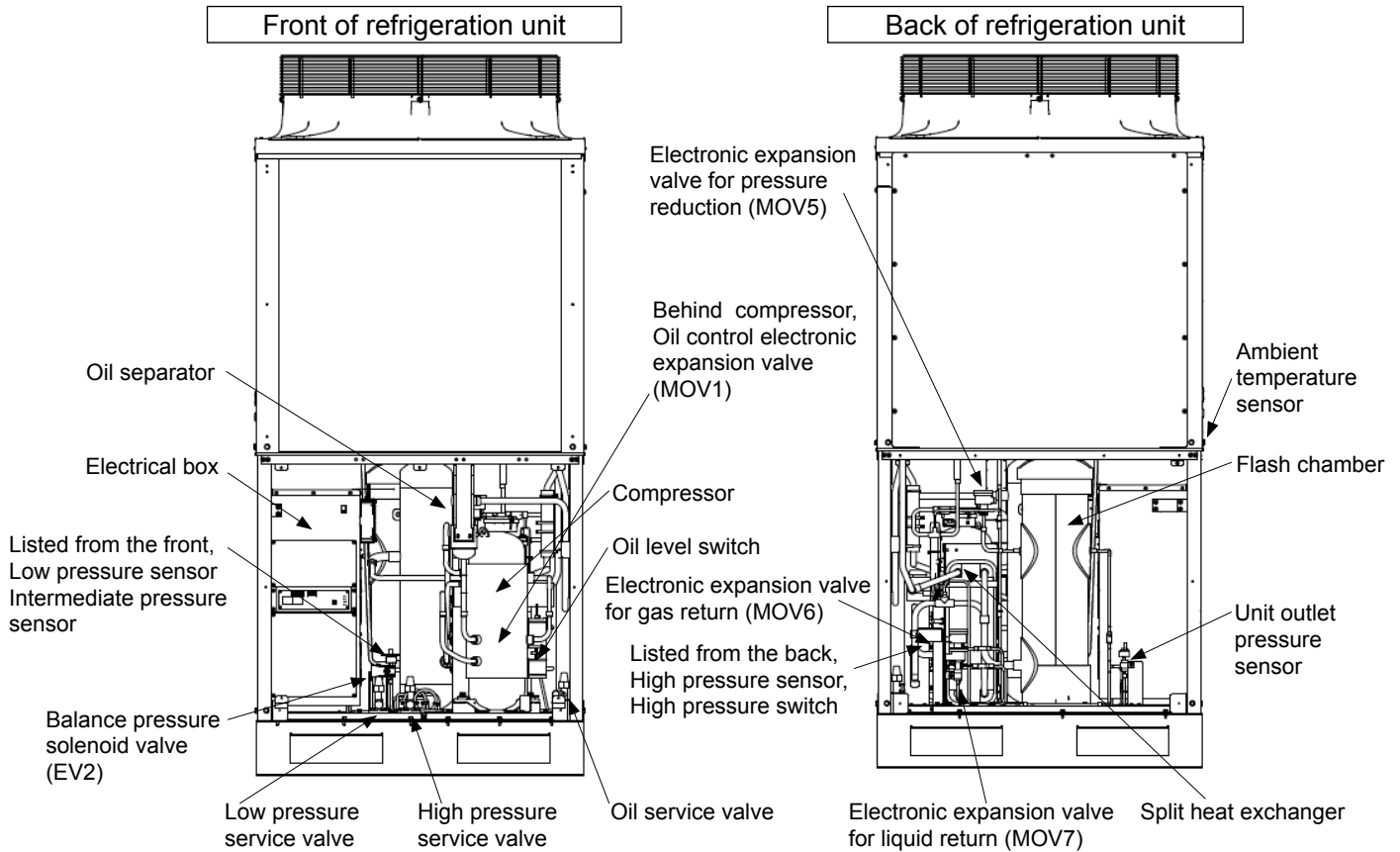

ENGLISH

Electrical box internal layout

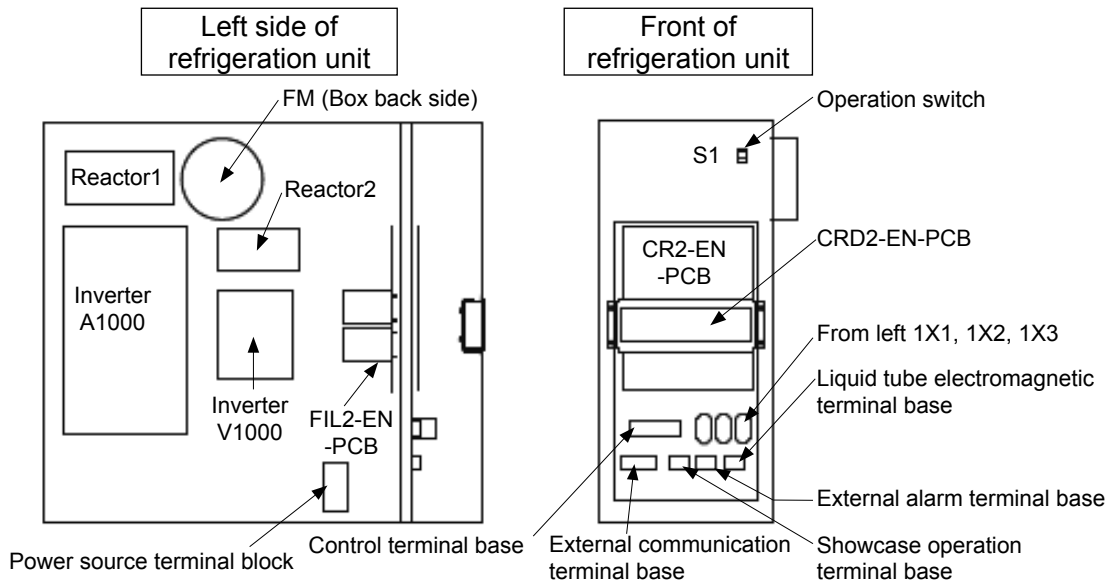

Optional Accessories

Name	Model No.	Applicable refrigeration unit	Remarks
Suction filter	S-008T	OCU-CR1000VF8A OCU-CR1000VF8ASL	Prevention of dust penetration
Filter Dryer	D-155T (Type: CO-085-S)		Ø 15.88 (Outer diameter welding)
Service piping	SPK-TU125		-

Note: Service piping is not included the unit.

The suction filter and filter dryer (one is shipped with each refrigeration unit) are a standard component. When replacing the suction filter and filter dryer, use the same suction filter (Model No. S-008T) and filter dryer (Model No. D-155T) shown above as the standard component.

Scope of Application, Specifications

This refrigeration unit operates with a rotary compressor.

Use the refrigeration unit within the range shown below.

Item	Standard Value	Remarks
Refrigerant	R744	The charge supply amount shall be adequate
Evaporating temperature	-45 °C to -5 °C	Temperature conversion of inlet pressure
Suction pressure	0.73MPa to 2.95MPa	Unit inlet pressure
Compressor rotational speed	30 s ⁻¹ to 60 s ⁻¹	* (RPS)
Suction gas temperature	18 °C or below	Unit inlet (suction gas) pipe temperature
Superheat at suction	10 K or above	Difference between evaporating temperature and compressor inlet temperature
Discharge pressure	9.1MPa or below (except transient)	Compressor outlet pressure
Discharge gas temperature	97 °C or below	Compressor outlet temperature
Oil temperature	100 °C or below (Ambient temperature +10 K or above)	
Ambient temperature	-15 °C to +43 °C	Gas cooler intake air temperature
Power source	3N ~ 50 Hz 380 V / 400 V / 415 V	Within ± 10 % of Rate Voltage
Installation inclination angle	1° or below	
ON/OFF cycle period	10 minutes or longer for ON/OFF cycle	Oil return shall be ensured
Installation	Outdoor	The foundation shall be rigid enough
Climatic class	0/1/2/3/4/6/8	Please see below "CLIMATIC CLASS"
Net Weight	320 kg	

* Operation may not be possible depending on the installed condition.

CLIMATIC CLASS

Test room climate class	Dry bulb temperature °C	Relative humidity %	Dew point °C	Water vapour mass in dry air g/kg
0	20	50	9.3	7.3
1	16	80	12.6	9.1
2	22	65	15.2	10.8
3	25	60	16.7	12.0
4	30	55	20.0	14.8
6	27	70	21.1	15.8
8	23.9	55	14.3	10.2

Excerpt from: EN ISO 23953

Countermeasures in a cold weather operation

In order to prevent excessive reduction of high pressure in a cold weather location, surrounding around the refrigeration unit should be made.

Scope of Application, Specifications

Rated Specifications

Item	Rating	Unit
Power source	3N ~ 50 Hz 380 V / 400 V / 415 V	V
Power input	8.200/8.200/8.200	kW
Current	13.3/12.6/12.2	A

Conditions

1. Evaporating temperature: -10 °C
2. Ambient temperature: 32 °C
3. Compressor rotational speed : 60 s⁻¹
4. Suction superheat : 10K

Performances (380 V / 400 V / 415 V)

Ambient temperature	Item	Symbol	Evaporating temperature -10°C	Evaporating temperature -35°C	Unit
	Annual electricity consumption	Q	32409	39985	kWh/a
	Seasonal energy performance ratio	SEPR	2.86	1.49	
32°C	Rated Cooling capacity	P _A	15.100/15.100/15.100	8.000/8.000/8.000	kW
	Rated Power input	D _A	8.200/8.200/8.200	7.570/7.570/7.570	kW
	Rated COP	COP _A	1.84/1.84/1.84	1.06/1.06/1.06	
25°C	Cooling capacity	P _B	15.200/15.200/15.200	8.400/8.400/8.400	kW
	Power input	D _B	7.200/7.200/7.200	6.500/6.500/6.500	kW
	COP	COP _B	2.11/2.11/2.11	1.29/1.29/1.29	
15°C	Cooling capacity	P _C	15.600/15.600/15.600	8.600/8.600/8.600	kW
	Power input	D _C	5.600/5.600/5.600	5.600/5.600/5.600	kW
	COP	COP _C	2.79/2.79/2.79	1.54/1.54/1.54	
5°C	Cooling capacity	P _D	15.800/15.800/15.800	8.600/8.600/8.600	kW
	Power input	D _D	4.550/4.550/4.550	5.550/5.550/5.550	kW
	COP	COP _D	3.47/3.47/3.47	1.55/1.55/1.55	
43°C	Cooling capacity	P ₃	12.400/12.400/12.400	6.900/6.900/6.900	kW
	Power input	D ₃	9.280/9.280/9.280	8.900/8.900/8.900	kW
	COP	COP ₃	1.34/1.34/1.34	0.78/0.78/0.78	

Compressor rotational speed : 60 s⁻¹, Suction superheat : 10K

Sound pressure level

The A-weighted sound pressure level does not exceed 70 dB(A).
(at a distance of 1 m from surface of product)

CO₂ Refrigerant Grade

Charge CO₂ refrigerant (R744) that is compatible with following specifications.

Item	Specifications
Purity	> 99.9 % (volume)
Moisture	< 0.005 % (volume)
Total sulfur	< 0.03 ppm (weight)
Inert gas (H ₂ , N ₂ , O ₂ , Ar)	< 0.01 % (volume)

For Effectively Using the Refrigeration Unit

Cautions for Installation Work

This refrigeration unit has been designed exclusively for R744 (CO₂ refrigerant).

Refrigeration oil and each component including the compressor have been exclusively designed for the refrigeration unit.

Please use sufficient caution for maintaining the reliability of the product.

- (1) Since CO₂ refrigeration cycle becomes high pressure during operation, use the piping material and other components particularly designed for CO₂ refrigerant with sufficient strength.
- (2) As the refrigeration oil has high moisture absorption property, make the opening time as short as possible. Connection of the piping to the refrigeration unit should be made at the last stage of piping installation work. Avoid outdoor work on a rainy day.
- (3) For piping work, use "phosphorous-deoxidized copper pipe" of refrigeration grade, clean, dehydrated and "phosphor-copper brazing solder".
If "silver brazing solder" is to be used, do not use any flux containing chlorine. During pipe brazing it is a must to use nitrogen over pressure.
- (4) Do not use pipe joints made for HFC refrigerant, because they do not have the required strength. In addition, absolutely do not use flared joints.
- (5) For the purpose of protecting the refrigeration unit and refrigeration cycle, be sure to install the included filter dryer at the liquid line of the refrigeration unit.
- (6) Gas leak detector used for airtight test should be foaming liquid or soap water. Do not use kitchen detergent. Kitchen detergent may corrode metals.

For Economically Using the Refrigeration Unit

For the purpose of using the refrigeration unit economically, consider the following.

Cooling capacity largely vary by the method of use.

Reduction of evaporating temperature (unit inlet pressure converted to temperature) reduces cooling capacity by 3 to 4%, and increase of discharge pressure decreases cooling capacity and increases power consumption.

In order to fully extract the unit performance, compressor suction pressure should be increased as high as possible, and discharge pressure should be made as low as possible. For this reason, caution should be used in the following points.

- (1) Make the piping resistance as small as possible.
Ref: Capacity change rate per 1 °C pressure loss of suction line

Evaporating temperature	Capacity change rate per 1 °C
-45 °C to -5 °C	2 % to 4 %

- (2) Select an evaporator of sufficient capacity for raising evaporating temperature as high as possible.
- (3) Do not block the cold air outlet in a refrigerator or showcase with food items.
- (4) Operate door opening of a refrigerator as quick as possible. (To avoid leak of cold air, reduce the time of door opening)
- (5) Periodically perform cleaning of the gas cooler to avoid clogging.

For Effectively Using the Refrigeration Unit

Caution for an Inverter-based Refrigeration Unit

- (1) Even after turning the power OFF, voltage still remains in the charged part. Until the LED (red) of the Inverter A1000 and Inverter V1000 turns off (until the capacitor discharges the potential), approximately 5 minutes are required. Do not touch the charged part.
- (2) Phase-advancing capacitor is prohibited
Do not attach a phase-advancing capacitor to an inverter compressor. It may cause inverter failure or capacitor breakage.
- (3) Inverter noise prevention
Take as much distance as possible from the wiring of a radio receiver or wired broadcasting.
Inverter noise may cause undesired noise sound.
- (4) The two-stage compression mechanism prevents temperature rise of the second stage discharge gas of the compressor.
During the operation with a small quantity of refrigerant in the refrigeration circuit, a protection device (the CR2-EN-PCB) makes the compressor to stop. Avoid refrigerant shortage operation.
- (5) Rotary compressor consists of high precision components. Use caution during piping work to avoid contamination of dust, metal powder, or oxide scale, etc.

Initial Oil Quantity

Model No.	Compressor	Oil separator
OCU-CR1000VF8A(SL)	1,800 mL	3,000 mL

Oil type	PZ-68S
----------	--------

Caution When adding oil or changing oil, be sure to use our specified oil.

Selection of Installation Location

General Cautions

Each unit of the equipment should be placed by selecting the most convenient location such as easy to install, operate or maintain.

- (1) Each unit should be placed to make the piping and wiring length as short as possible and easy to install.
- (2) Controller should be located within the reach of the user's hand for convenient daily operations (RUN, STOP, reset warning, etc.). Do not locate the controller in a place easily accessed by the people other than the user.
- (3) Install the refrigeration unit at a location easy to be serviced for daily maintenance and inspection.
Daily maintenance and inspection involves checking the operation pressure, compressor operation condition for abnormal sound or vibration.

Selection of Installation Location

Location not disturbing neighbors

Avoid air-blow from the gas cooler to the neighbor's window or noise to disturb other people.

Location with a sturdy and level surface

Install the refrigeration unit on a firm foundation to avoid an increase of noise and vibration. Particularly at the boundary from the neighbor's lot, comply with the regional laws and regulations.

Location away from a heat source

Installation should not be affected by reflection from the floor.

Location with good ventilation

To ensure good ventilation, installed location should ensure the intake air by the gas cooler is 43 °C or below with good airflow.

Location not affected by a wet floor

Refrigeration unit is often affected by rainwater and drain water from defrosting. Apply drain water work as required.

Location not affected by snow accumulation

Installation in a cold weather location should avoid snow accumulation and attachment of frost or freezing by furnishing a roof.

Direction for avoiding strong wind

Install the refrigeration unit with its blow-out side facing perpendicular to the wind direction.

Carry-in/Installation

Carry-in Operation

- (1) Carry the refrigeration unit gently by keeping the vertical position as much as possible.
- (2) Absolutely avoid a lay-down position of the refrigeration unit.
- (3) When conveying the refrigeration unit with a forklift, maintain the unit vertically by using the square holes at the corners of the unit base.

Hang Operation

When hanging the refrigeration unit, use caution for the following points.

When hanging the refrigeration unit, follow the "Precautions for Hanging the Product" attached to the refrigeration unit.

When hanging the refrigeration unit and conveying it, keep it level without causing any impacts.

Hang rope, etc. must be strong enough to withstand the weight of the refrigeration unit.

Carry-in/Installation

Foundation/Platform Work

- As a reference, the foundation should be made from concrete having a mass about 3 times that of the refrigeration unit. (Absorbing vibration by mass)
- Vibration should be reduced by a platform or anti-vibration pad for avoiding transmission of vibration to the floor and wall.
- To avoid falling, secure the refrigeration unit by using anchor bolts. (Use all securing positions)
- The refrigeration unit must be installed with an inclination angle 1° or below.
- The refrigeration unit must be installed below the altitude of 2,000 m.

If a foundation meeting the requirement above cannot be secured, be sure to check that no abnormal vibration is generated by resonance of the refrigeration unit and piping system.

- (1) Basic foundation work when the pipe is extended horizontally.
On a concrete foundation 150 mm or higher from the floor surface, place anti-vibration pads (Approx. 8 to 15 mm thick) and secure the unit on the entire unit base by anchor bolts.
- (2) Basic foundation work when the pipe is extended downward.
Form an elevated foundation with vertical columns.
Place an anti-vibration pad (thickness of 8 to 15 mm) on the entire surface of the foundation and secure it with anchor bolts.
- (3) Anchor bolts
Use M8 size anchor bolts and buried at least 100 mm on the concrete foundation.
Fix unit with double nut and plain washer (28 mm O.D. minimum).

External Dimensions

(Units: mm)

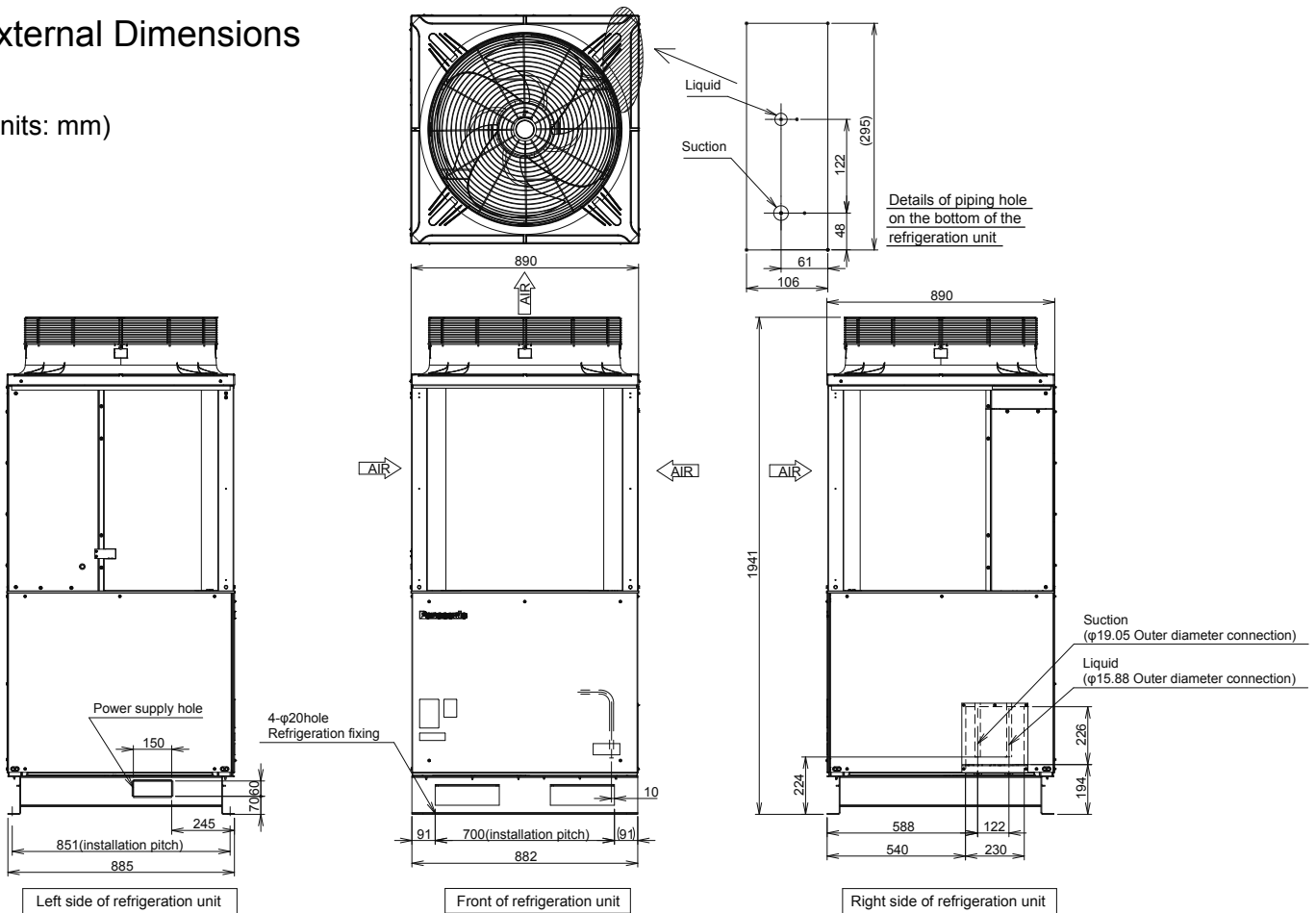

Optional Accessories

The following service piping (optional) is required for the installation and service work of the refrigeration unit.

Service piping for Evacuation, Airtight test, and Refrigerant charging (Model No. SPK-TU125)

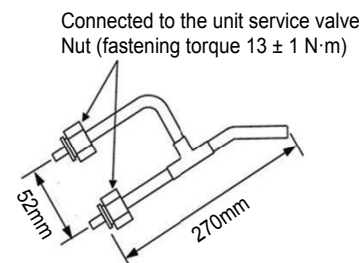

Installation Example

Standard installation

The gas cooler is designed to take air from 3 directions, including the front, left and right side, and blow out from the top.

- (1) Secure a service space of 500 mm or more on the front and left sides.
- (2) Secure a service space of 300 mm or more on the back and right sides.

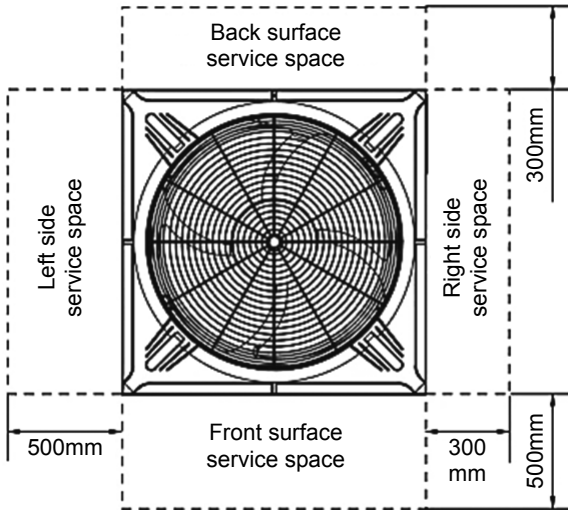

When there's an obstacle in the upward direction

When there's an obstacle in the upward direction, the installation should not cause a short cycle of the gas cooler air exhaust.

When installing a roof, it should be located at a distance of 1.5 m or more with an upward slope, as illustrated on the right.

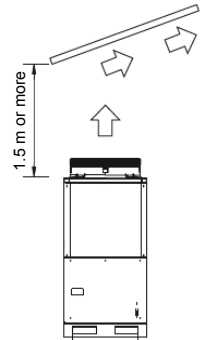

Protection in the snowfall areas

- (1) Install a snow protection shed at the air outlet of the gas cooler. (On-site installation)
- (2) The entire refrigeration unit should not be surrounded by accumulated snow.

Installation example

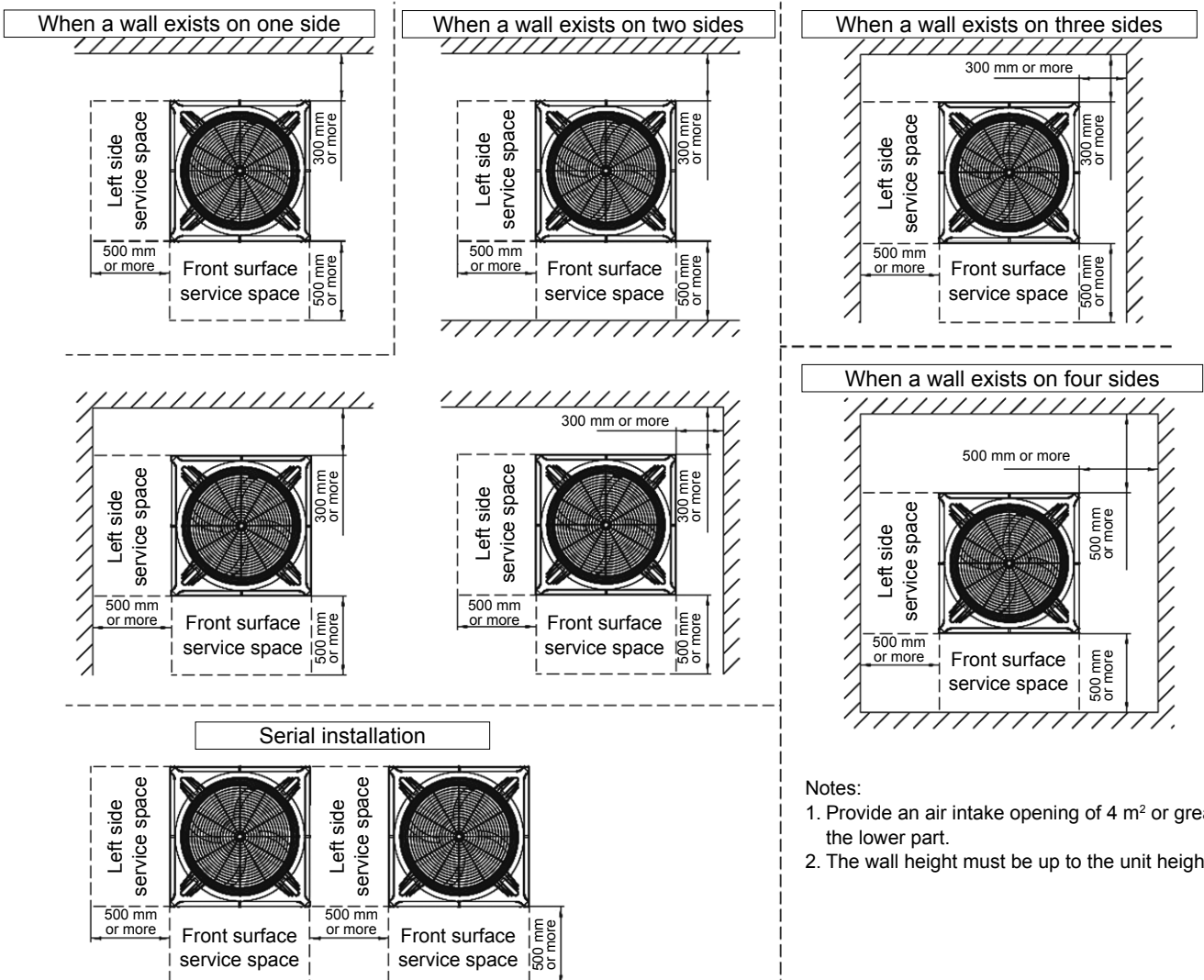

Notes:

1. Provide an air intake opening of 4 m² or greater at the lower part.
2. The wall height must be up to the unit height.

Refrigerant Piping Work

Design and installation of the refrigerant piping work largely affect the performance of the refrigeration unit as well as the product life and problem occurrence.

Installation work should comply with the following items. Installation of all equipment have to be in accordance to Pressure directive 2014/68/EU and European norm EN 378 «In the European Market».

Or, Australian norm AS/NZS 5149 «In the Australian and New Zealand market».

Selection of Refrigerant Piping Size

The connection piping size for refrigeration unit is, in principle, as shown below, but each should be determined by calculating pressure loss of the piping and refrigerant flow speed and making sure no problem occurs in the cooling capacity and oil return.

As refrigeration unit using CO₂ refrigerant incurs pressure higher than when using HFC refrigerant, it is necessary to choose adequate materials.

Model No.	Suction line (Unit inlet)	Liquid line (Unit outlet)
OCU-CR1000VF8A(SL)	Ø19.05 mm, 3/4"	Ø15.88 mm, 5/8"

Note: Welding is outer diameter welding.

- Piping material should be seamless phosphorous-deoxidized copper pipes (refrigeration grade), K65.
- When cutting pipe, use a pipe cutter and always remove burrs.
- When bending pipe, secure a bending radius 4 times or greater of the outer diameter. During bending, pay attention to distortion and scars.

Caution

Use sufficient caution for handling piping by sealing the pipe end with tape or any other cover for avoiding entry of contaminants and moisture into the pipe.

Refrigerant Piping Work

Cautions for Heat Insulation Work

- Apply heat insulation on the suction line and liquid line for avoiding thermal effect from outside.
- Do not wrap together the suction line and liquid line with heat insulation material. (Refer to the right illustration)
- Apply heat insulation only after executing airtight and pressure test.

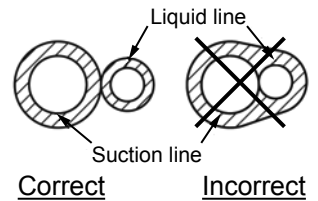

Prevent contamination of foreign objects such as dust, metal powder, oxide scale, etc.

Since the compressor consists of high precision components, contaminants generate scratches on the sliding surfaces, thereby increasing gas leak, deteriorating performance, and causing excessive wear and seizure.

- Flow nitrogen gas during welding.
- Piping inside and outside must be clean.
- Avoid mixing of debris during cutting and deburring copper pipe.

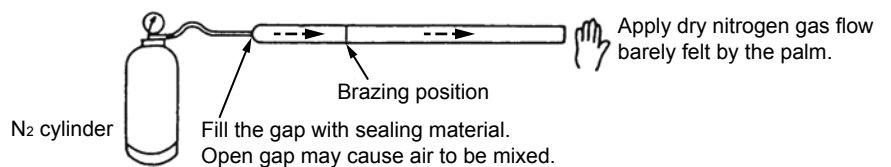

Airtight Test

Pressure testing should only be carried out by personal / companies who have necessary certification.

Consider carefully local regulations and EN378.

Outer side	Inner side
8MPa	8MPa

Piping Direction

The pipe can be connected from 2 directions (right side or bottom of the refrigeration unit).

When connecting the refrigerant pipe, remove the right side panel.

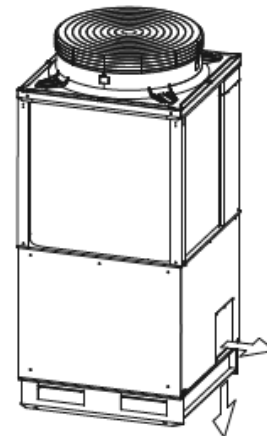

Caution for Gas Leak

Gas leak may lead to excessive heat operation of compressor and air-mixed operation, thus causing compressor failure.

Securely execute airtight test.

Suction Filter

Be sure to install the suction filter available as optional accessory.

Model No. S-008T

Filter Dryer

Be sure to attach the included filter dryer.

Model No. D-155T (Type: CO-085-S)

Piping Example

Total piping length should be limited to 100 m one way.
When the piping length exceeds 50 m, add oil refer to "Oil Level Control Method".

When the evaporator is located higher

- Height difference 5 m or below
- The suction line should ideally slope gently towards the unit. Recommendation slope is 1/200~1/250.
- Refrigerant pipe should be covered with heat insulation material on both suction line and liquid line. Since liquid line becomes approx. 0 °C during operation, apply heat insulation of 20 mm or more in thickness.

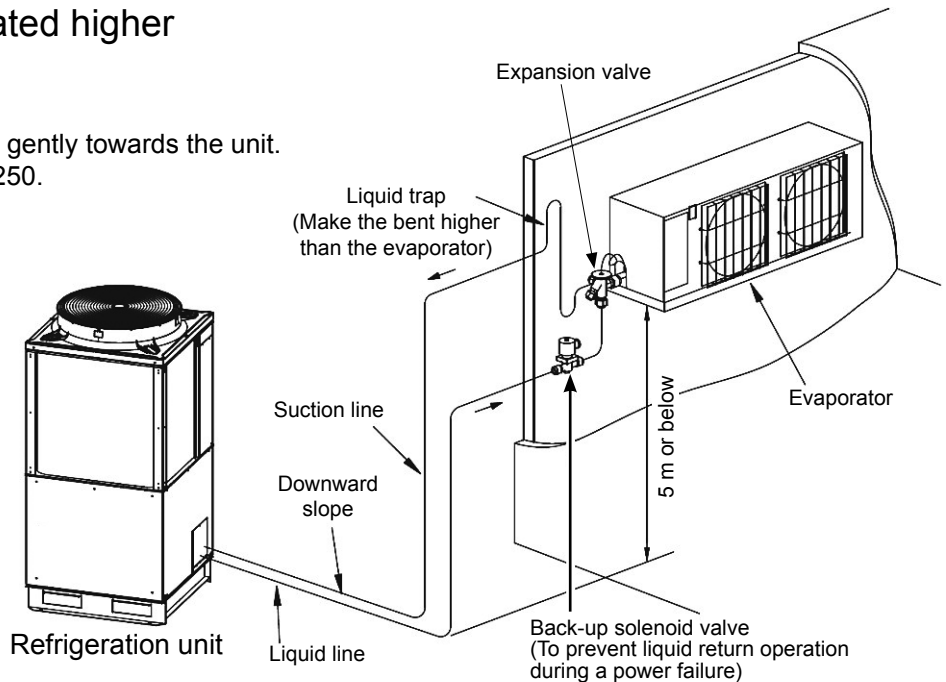

When the evaporator is located lower

- Height difference 20 m or below
- To promote good oil return in the suction line, piping size and trap need to be considered.
- The suction line should ideally slope gently towards the unit. Recommendation slope is 1/200~1/250.
- Refrigerant pipe should be covered with heat insulation material on both suction line and liquid line. Since liquid line becomes approx. 0 °C during operation, apply heat insulation of 20 mm or more in thickness

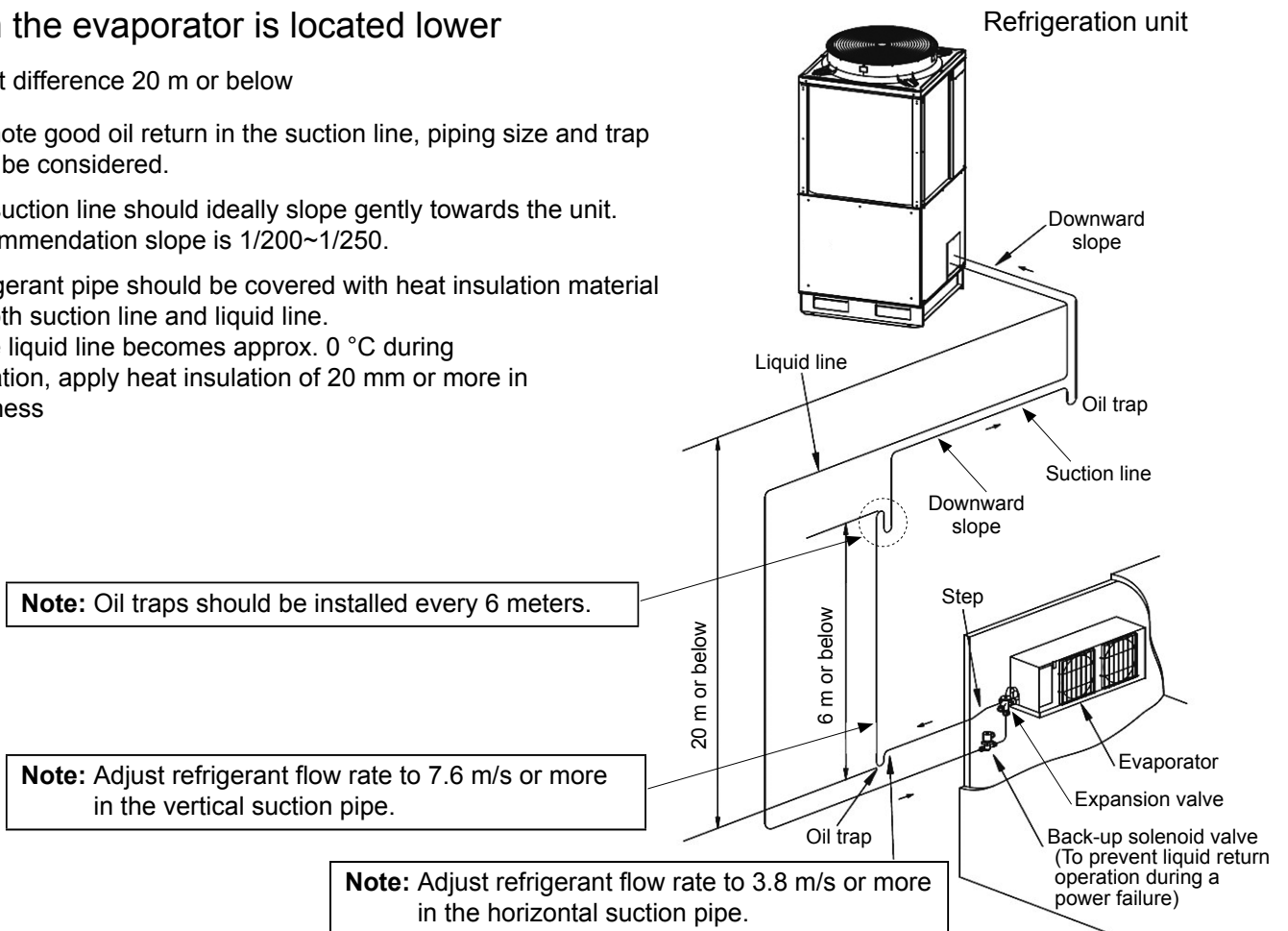

Refrigerant Circuit Diagram

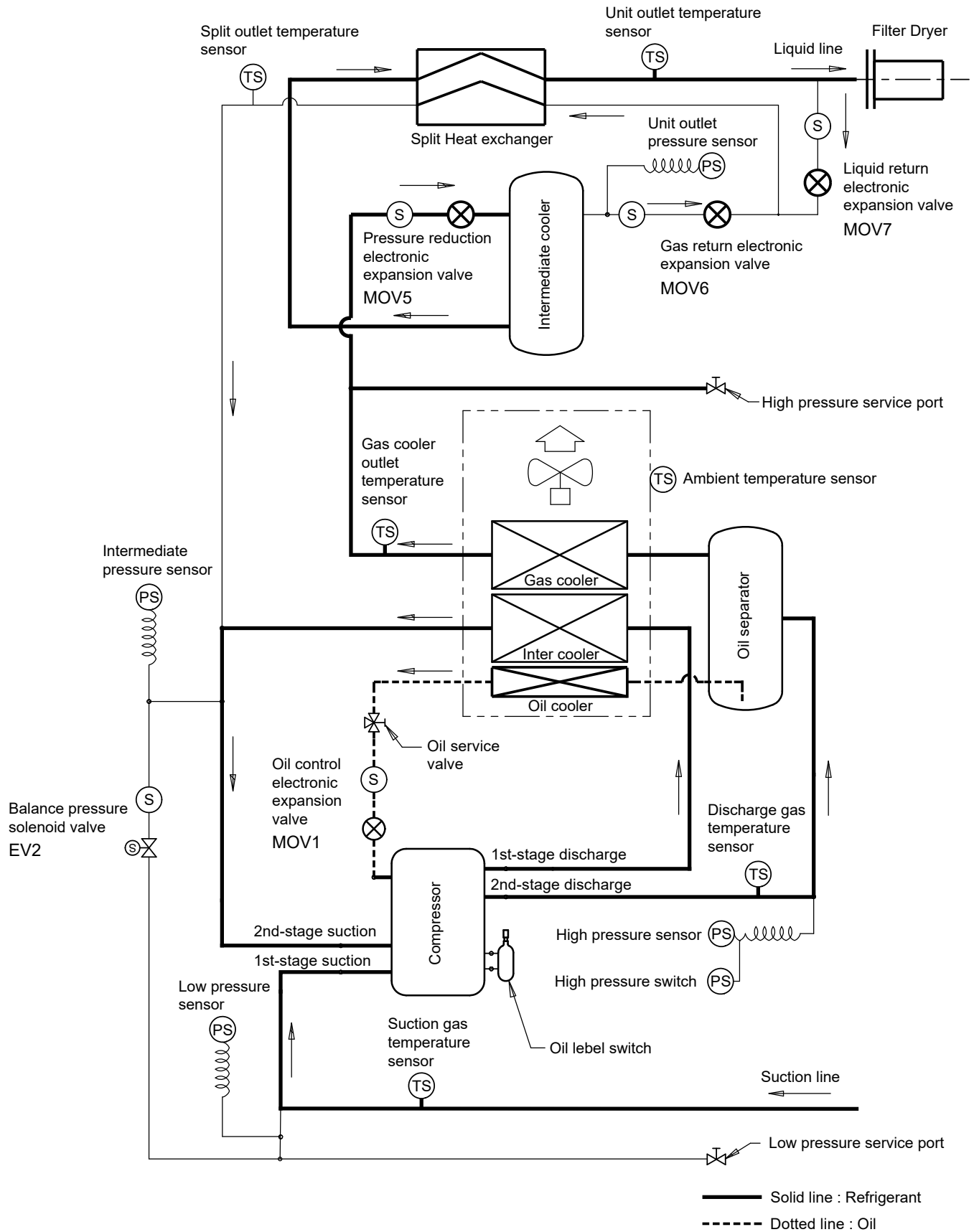

Refrigerant Charging

Evacuation (Perform after completing electrical wiring.)

To avoid inclusion of air or moisture in the refrigerant circuit, be sure to execute vacuum drying of the entire circuit by using a vacuum pump, before charging refrigerant. By following procedure, execute evacuation after securely carrying out airtight test.

- (1) Connect electrical wiring
- (2) Enter the Vacuum Mode by following sequence
 - Check the Electrical Circuit Breaker to be OFF (No electric power charged to the unit)
 - Turn the No.1 and 2 of 8P Dip Switch (SW13) ON. No. 3~8 shall be OFF.
 - Set the Slide Switch (SW15) to [CHECK].

then,

- Turn the Electrical Circuit Breaker ON.
- Turn the Operation Switch (S1) to ON.
- Set the Rotary Switch (SW11) to [OPERATION]
- Check that [uAcU] is indicated in the 7-segment LED.
7-segment LED shall indicate
"Low Pressure → High Pressure → Unit outlet Pressure → [uAcU] → Low Pressure →".

Check Operation Switch (S1) is ON.

If yes, the unit is confirmed to enter Vacuum Mode (even though 7-segment LED is showing [uAcU], the unit is not in the Vacuum Mode if (S1) is OFF).

In the Vacuum Mode, all electronic expansion and solenoid valves open.

- (3) Evacuation
 - Connect the vacuum pressure gauge and vacuum pump to the low pressure and high pressure service ports, and open both.
 - Apply evacuation from the two ports.
 - Evacuate down to 133 Pa (1 Torr), target level for evacuation, and continue for 1 to 3 hours.
 - Execute the refrigerant charging immediately after evacuation, according to the charging procedure described in the next page.

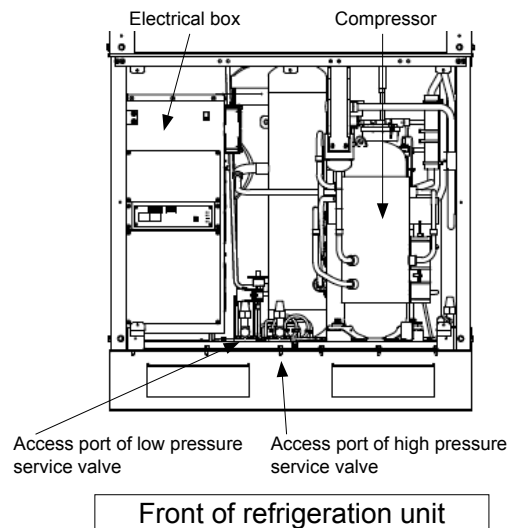

Refrigerant Charging

Method of Charging

Execute the refrigerant charging immediately after evacuation.

R744 (CO₂) shall be used and do not mix other refrigerant.

Refrigerant shall be charged by following procedure.

(1) Preparation (Unit shall be under Vacuum mode)

- Close the vacuum valve of the manifold gauge set exclusively for CO₂ refrigerant, and separate the vacuum pump.
- Place the refrigerant cylinder on the platform scale, and remove air in the tube.
The platform scale shall be on a flat surface and zero-point adjustment shall be performed.

(2) Initial charge (Unit shall be under Vacuum Mode)

- Check that low pressure and high pressure service ports are open to charge refrigerant.
- Slightly open the charge valve of manifold to charge the refrigerant up to about 0.5MPa.

(3) Additional charge (Unit shall be under Normal Mode)

- Close the high pressure service port. Low pressure service port remains open.
- Set the Slide Switch (SW15) to [CONTROL]
- Turn No.1 of 8P Dip Switch (SW13) OFF. No.2 remains ON.
- Turn the Operation Switch (S1) ON and let the compressor start.
- Slightly open the valve of cylinder to let the unit suck in the refrigerant from low pressure service port.
- Continue charging until target refrigerant amount is charged (charge amount can be checked by scale).
- Close the low pressure service port to complete the charge.

(4) Charge amount

- Adequate charge amount can be calculated by the tool provided by Panasonic.

The below can be referenced in addition to above.

In the case of a refrigeration showcase = $825 \text{ (g / m)} \times \text{showcase length (m)} + 90 \text{ (g / m)} \times \text{piping length (one-way: m)}$

Note: 1. Do not absolutely charge liquid refrigerant from the low pressure side (low pressure service port).

2. To avoid overcharging, charging rate should be around 20 g per 5 sec.

3. If it is difficult to adjust refrigerant charging rate by operating the joint valve and manifold gauge set charging valve, attach a capillary tube between the refrigerant cylinder and manifold gauge set.

4. Do not attach a capillary tube between the manifold gauge set and service piping.

5. For the method of charging refrigerant, refer to the service manual "Refrigerant Charging Operation Procedure".

Refrigerant quantity adjustment should conform to the "Refrigerant Quantity Adjustment of Refrigeration Unit" in the section "Adjustment during Operation".

(5) After completing refrigerant quantity adjustment, close the refrigerant cylinder valve and check that the low pressure and high pressure service ports have been closed.

(6) Slowly open the vacuum valve or purge port of the manifold gauge set to emit the remaining refrigerant in the service piping and manifold gauge set.

Note: Since refrigerant becomes cold when released, use caution when opening the valve for frost bite.

(7) After completing the operation, check gland nut loosening of the low pressure and high pressure service valves and fasten them if any looseness exists. Fastening torque is $10 \pm 2 \text{ N}\cdot\text{m}$.

Cautions for Electrical Wiring Work

Electrical work must be carried out by a certified electrician according to the local requirements, regulations and laws.

Electrical Shock and Fire Prevention

- (1) Apply grounding wiring.
- (2) The circuit must not be shared with other circuits. (The wire should not be shared with other equipment)
- (3) Electric wire should not touch high temperature components (compressor, gas cooler, discharge piping, etc.) and any metal edge.

Selection of a Ground Fault Protector and Wiring

Model No.	Ground fault protector		Power line thickness for wiring length (mm ²)				Grounding wire cross sectional area (mm ²)	Control circuit cross sectional area (mm ²)
	Rated current	Detected current	10 m	20 m	30 m	50 m		
OCU-CR1000VF8A(SL)	30 A	30 mA	5.5	5.5	8	14	2.5	1.0

Notes:

1. Wiring and cabling quality need to follow local standards, regulations and laws.

IEC: 60245 IEC57
 CENELEC: H05RN-F
 AS/NZS : 3000

2. Use shielded cable for communication line, liquid tube electromagnetic valve line and showcase operation signal line.

Electrical Wiring Work

Wiring Block Diagram Example

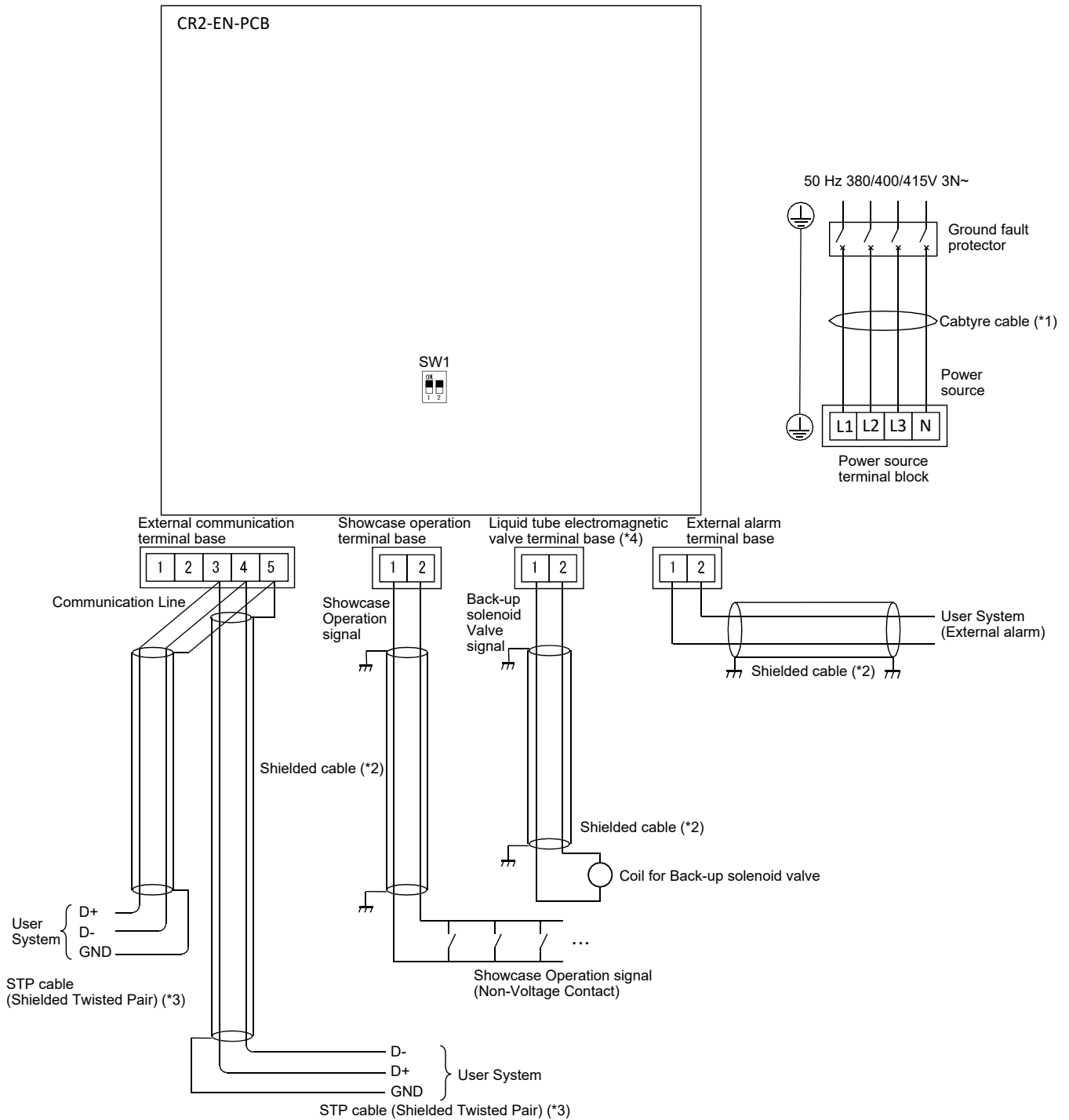

Caution

- *1 : Use the cabtyre cable Power Line.
- *2 : Use shielded cable for liquid tube electromagnetic valve line, showcase operation signal line and external Alarm Line.
The shield Line connect the screw with FIL2-EN-PCB earth line when the shield Line do not ground at the connected equipment.
- *3 : Use shielded twisted pair cable for communication line.
- *4 : 50 Hz 220/230/240 V ~ output

Electrical Wiring Work

Wiring Guide Opening

Wiring guide opening is located on the left side of the refrigeration unit.
(A square hole is provided in the unit base for electrical wiring.)

By using a cable bundling tie attached to the bottom section of the electrical box, bundle the power cable, grounding wire, communication wires, etc. and eliminate slack in wires by using the bundling wire located at the wire guide opening of the electrical box.

Power line and communication line connect to Refrigeration Unit through conduit.

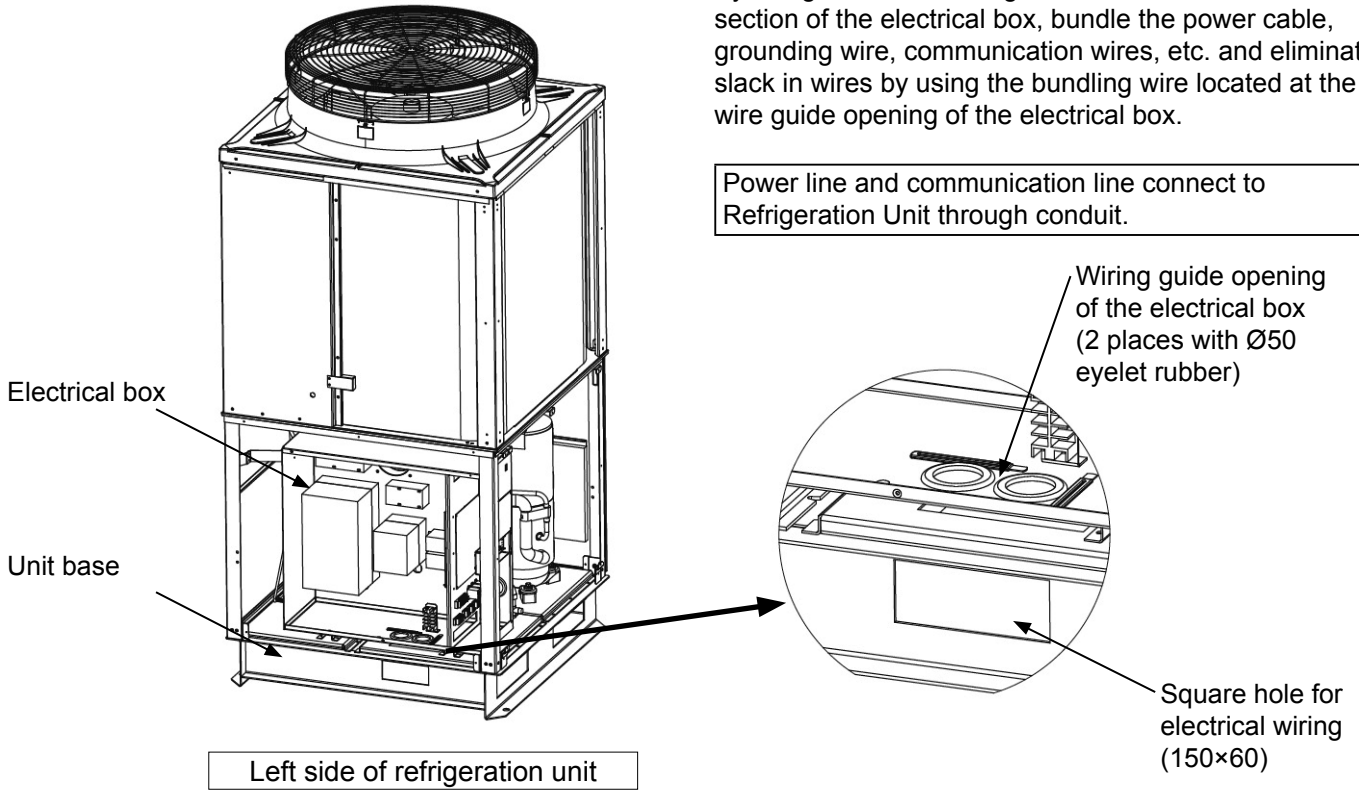

Caution

When the panel attachment after work is incomplete, penetration of rainwater is possible. Securely fasten the panels after work.

Electrical Circuit Diagram

Electrical circuit diagram (Standard electrical wiring diagram)

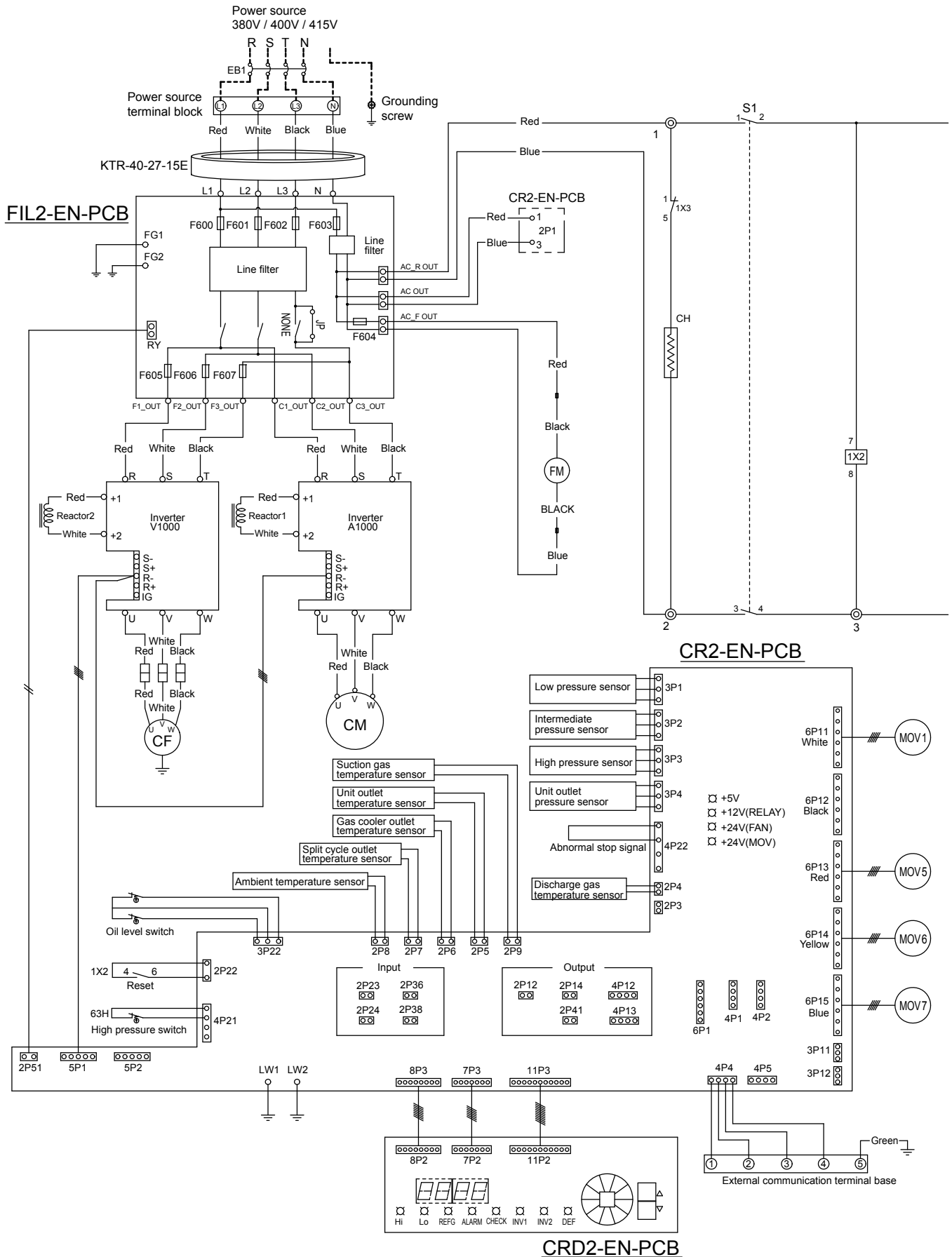

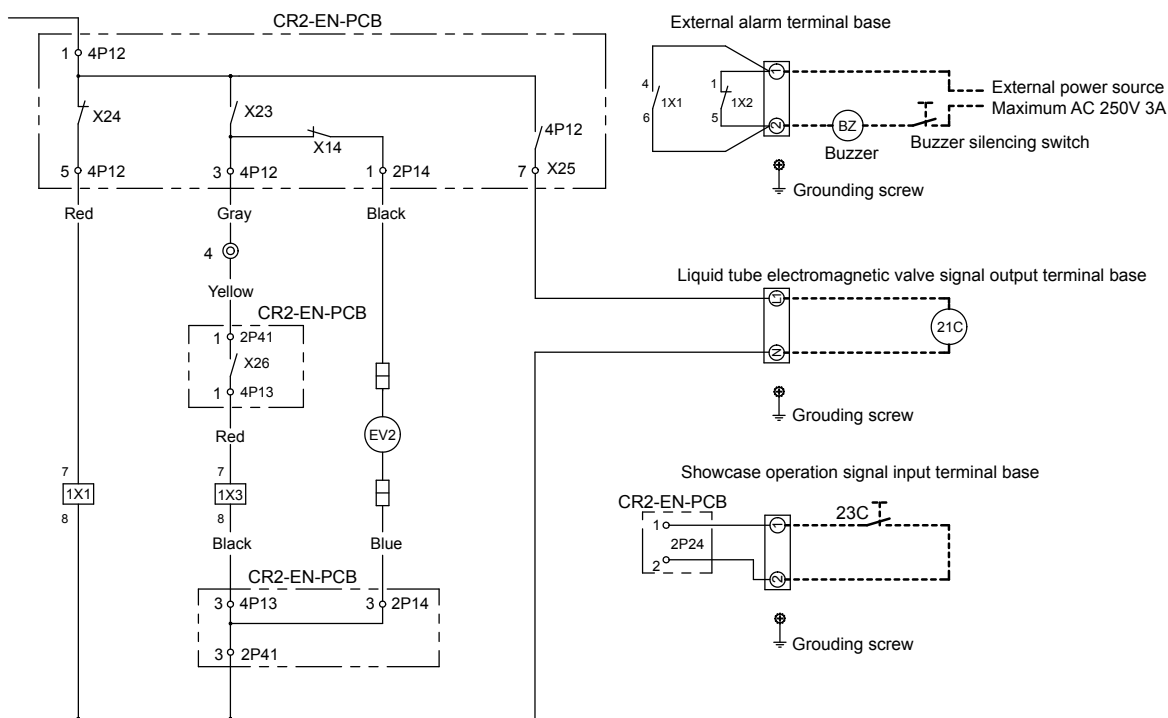

Electrical box internal layout

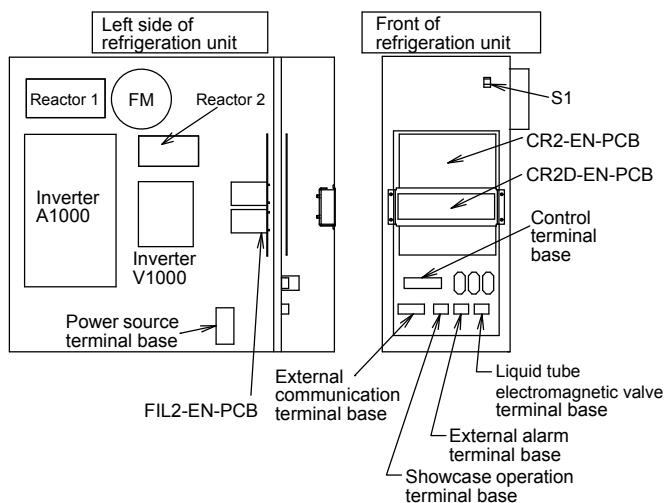

Symbol	Name	
S1	Operation switch	
1X1-3	Auxiliary relay	
CM	Compressor motor	
CH	Crankcase heater	
CF	Gas cooler fan motor	
FM	Electrical box cooling fan motor	
MOV1	Oil control electronic expansion valve	
MOV5	Electronic expansion valve for pressure reduction	
MOV6	Electronic expansion valve for gas return	
MOV7	Electronic expansion valve for liquid return	
CR2-EN-PCB	Compressor capacity control, oil level and other protection control	
X23: Operation/protection, X24: External alarm		
X25: Backup solenoid valve		
EV2	Balance pressure Solenoid valve	
EB1	Earth leakage circuit breaker	*
21C	Liquid tube electromagnetic valve	*
23C	Compartment temperature adjustment thermostat	*2
63H	High pressure switch	
BZ	External abnormally alarm buzzer	
⊙	Control terminal base	
—	Factory wiring	
- - -	Local wiring	

(Cautions)

1. Connect the grounding wire at the indication label without fail.
2. The components marked * need to be acquired locally. However, *2 is included in the showcase.
3. Connect external alarm (no-voltage contact) at the external alarm terminal base.
4. Stopping the refrigerating equipment: Turn S1 to stop. To stop for a long time, turn OFF also EB1.
5. When alarm is generated, check the abnormality content, eliminate the cause of the problem, and then turn ON the power.
6. Local wiring should be shielded cable.

What Needs to be Checked before Operation

Confirmation before Operation

- (1) Please recheck if any incorrect wiring or loose wiring exists.
- (2) Check that the power supply voltage is within $\pm 10\%$ of the rated voltage.
- (3) Check that insulation resistance is 1 M Ω or greater.

Power Supply to the Crankcase Heater

When restarting after power shutoff of the ground fault protector, crankcase heater must be turned ON for 6 hours or longer before operating the compressor for avoiding oil-forming at starting.

(With the operation switch on the refrigeration unit side OFF, and the ground fault protector ON, wait for 6 hours or longer before turning ON the operation switch.)

Caution

Turning the ground fault protector ON causes power to be applied to the crankcase heater. Do not touch by hand.

Protection of High Pressure

The set value of high pressure abnormality is shown in the table below.

Refrigerant	R744
Set value	11.7MPa

Setting and Indication

This refrigeration unit is equipped with the function of setting a variety of compressor operation modes by the switch on the CRD2-EN-PCB.
 Operating condition of the compressor can be checked by the 7-segment LED.
 In particular, when any abnormality occurs in the refrigeration unit, an alarm LED (Red) lights up or blinks, and the cause of abnormality is displayed digitally by an error code.

Switch and Indication

CRD2-EN-PCB

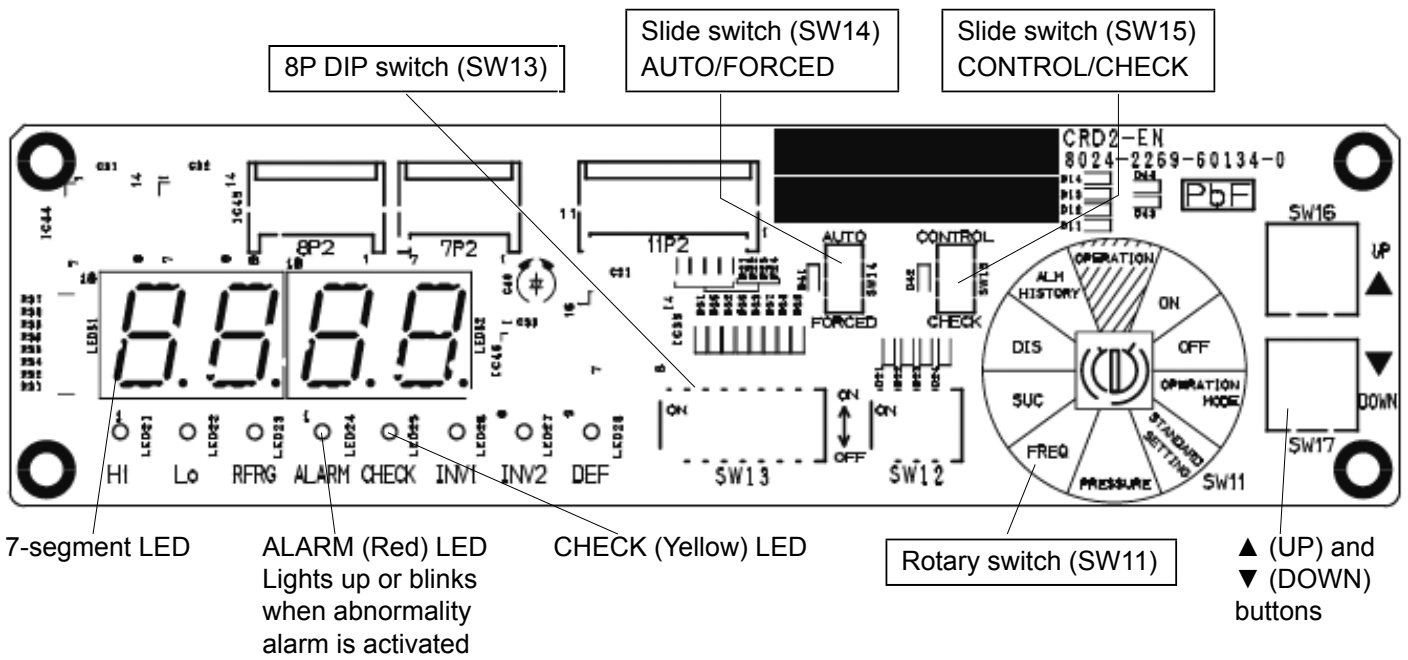

Setting and Indication

Switch Setting

(1) AUTO/FORCED switch (Slide switch, SW14)

SW14	Function	Remarks
 AUTO FORCED	Auto	
	Forced	Not yet used

(2) CONTROL/CHECK switch (Slide switch, SW15)

SW15	Function	Remarks
 CONTROL CHECK	CONTROL	Normal Mode
	CHECK	Special Mode Evacuation Mode (DIP switch SW13 setting is also required)

(3) 8P DIP switch (SW13)

The following functions can be selected. Change setting as required.

Switch setting at factory shipment is No.2: ON, other (No.1, No.3~No.8) : OFF.

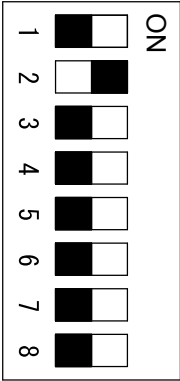
SW13	No.	Function with ON	Remarks
			
	1	Evacuation	No.3, 4, 5, 6, 7, 8: OFF, SW15: CHECK
	2	Always ON	
	3	Always OFF	
	4		
	5		
	6		
	7	Back mode 2	No.1, 3, 4, 5, 6, 8: OFF
	8	Back mode 1	No.1, 3, 4, 5, 6, 7: OFF

Setting and Indication

Low Pressure Setting

- (1) Turn OFF the operation switch S1.
- (2) Power ON
- (3) Low Pressure Setting (ON value, OFF value ,Diff.value)
 The Low pressure setting at the shipment is as shown in No.3 of the “Standard Pressure Setup Table” below.
 Since the Target Low Pressure Setting can be changed, use the following procedure as required.
 - Turn OFF the 8P DIP switch (SW13) No.1 and No.3 ~ No.8 (All OFF except No.2)
 - Set the rotary switch(SW11) to [STANDARD SETTING].
 The 7-segment LED displays [F].
 - Press ▲ or ▼ button to select the desired number Each set value for the number is shown in the table below.
 - Set the rotary switch (SW11) to [OPERATION]

<Standard Pressure Setup Table>

No.	Use	Compartment temperature (°C)	Evaporating temperature (°C)	ON value (MPa)	OFF value (MPa)	Low-press. Diff. value (MPa)	Lim value (MPa)
1	Refrigerator	+3 to +10	-5	3.32	3.08	0.24	2.84
2	Veg, fruits, etc.	+2 to +10	-7	2.98	2.86	0.24	2.62
3	Meat, fish	-5 to 0	-12	2.60	2.48	0.24	2.24
4	Freezer, ice	-30 to -22	-35	1.36	1.24	0.12	1.12

Lim value: Lowest low pressure to cause the compressor to stop. Lim value = OFF value - Diff. value

- (4) Target Low Pressure confirm and adjustment
 - Turn ON the 8P DIP switch (SW13) No.8.
 - Turn OFF the 8P DIP switch (SW13) No.1 and No.3 ~ No.7.

 - Set the rotary switch (SW11) to [ON]
 The 7-segment LED displays “ON value”.
 To change the ON value, press ▲ or ▼ button.
 “ON value” range is from 0.76 MPa to 5.00 MPa, and it must be larger than “OFF value” by 0.08 MPa or more.

 - Set the rotary switch (SW11) to [OFF].
 The 7-segment LED displays “OFF value”.
 To change the OFF value, press ▲ or ▼ button.
 “OFF value” range is from 0.68 MPa to 4.92 MPa, and it must be smaller than “ON value” by 0.08 MPa or more.

 - Set the rotary switch (SW11) to [OPERATION MODE].
 The 7-segment LED displays “Diff. value”.
 To change the Diff.value, press ▲ or ▼ button.
 “Diff. value” range is from 0.08 MPa to 1.84 MPa, and “Lim value” must be 0.58 MPa or more.

 - Set the rotary switch (SW11) to [OPERATION].
 Then the ON value and OFF value are stored in memory.

Setting and Indication

Indication

(1) Individual LED of CRD2-EN-PCB

Name	Color	Condition when the LED lights up
Hi	Yellow	The low pressure is equal to the Control "ON value" or higher.
Lo	Yellow	The low pressure is equal to the Control "OFF value" or lower.
ALARM	Red	Lights up/blinks in the event of an anomaly or when an alarm condition is generated. For details, refer to the "Description of Abnormality Alarm" in "About Alarms."
CHECK	Yellow	ON: In the PCB check mode, or evacuation mode Blink: Slide switch SW15 [CONTROL/CHECK] is set to [CHECK].
INV1	Green	Lights up during compressor operation.
INV2	Green	Not apply
DEF	Green	ON: Defrosting in operation Blink: In the evacuation mode, Electronic expansion valve in manual control

(2) 7-segmentLED

When the rotary switch (SW11) is at [OPERATION], the display indicates 1. through 4. below.

1. Normal operation

During normal operation, the display alternates between low pressure (MPa) → High pressure (MPa) → Unit outlet pressure (MPa). Indicates "Lo" when low pressure is below 0.00. For identification purposes, "H" is added to the end of high pressure, and "o" to the end of unit outlet pressure.

(E.g)



2. When an alarm condition is generated.

The display alternates between low pressure (MPa) → High pressure (MPa) → Unit outlet pressure (MPa) → Error content.

(E.g.)

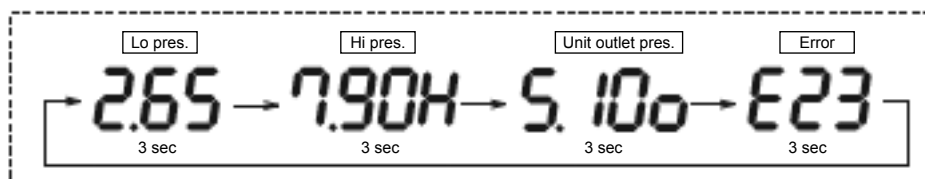

3. Method of fixing indication of low pressure

Pressing ▼ button during normal operation fixes the low pressure display for 10 minutes.

Pressing ▼ button again cancels the fixed display.

However, during alarm is generated, low pressure indication cannot be fixed.

4. The point at the lowest digit of the digital display (right bottom)



Blinks: Short cycle prevention function is in operation (compressor stopped).

Setting and Indication

Setting/Display Listing

Digital display and operation list

Mode	DIP switch SW13-8	DIP switch SW13-7	Rotary switch (Knob) position	Display/Setup		Remarks
Standard mode	OFF	OFF	OPERATION	Low pressure and high pressure is displayed alternately.	Low pressure: Lo.0.00 to 9.98 (MPa) High pressure: Lo-H, 0.00H to *** H (MPa)	▲ pressing: Red LED blinking cancelled During pressing ▼: evaporating temperature Pressing ▼ and release: low pressure (Only when no error is indicated)
			ON	"ON value"	0.76 to 5.00 (MPa)	Setting cannot be changed.
			OFF	"OFF value"	0.68 to 4.92 (MPa)	▲ pressing: "Lim value" ▼ pressing: "Diff value"
			OPERATION MODE	Operation mode	[FrE] display	Setting cannot be changed.
			STANDARD SETTING	Standard pressure selection	[F] display	▲ pressing: Up the set value ▼ pressing: Down the set value
			PRESSURE	Hi / Med / Unit outlet / Lo pressure	High pres: *** H (MPa) Med pres: *** c (MPa) Unit outlet pres: *** o (MPa) Low pres: *** (MPa)	▲ pressing: displayed data change ▼ pressing: displayed data change
			FREQ (FREQUENCY)	Compressor Rotational Speed	** . ** (s ⁻¹)	[Ex] In the case of 10 (s ⁻¹) → xx.0 In the case of less than 10 (s ⁻¹) → x.00
			SUC (SUCTION)	Suction gas temperature	**** (°C)	▲ pressing: Suction heating rate(K) ▼ pressing: Unit outlet temperature (°C)
			DIS (DISCHARGE)	Discharge gas temperature	**** (°C)	
			ALM HISTORY	Alarm history error code display	E *** (Error code) Latest 50 items (Older data erased)	▲ pressing: Older data ▼ pressing: Newer data
Back mode 1	ON	OFF	ON	"ON value" setting	0.76 to 5.00 (MPa)	▲ pressing: Up the set value ▼ pressing: Down the set value
			OFF	"OFF value" setting	0.68 to 4.92 (MPa)	
			OPERATION MODE	"Diff. value" setting	0.08 to 1.84 (MPa)	
			STANDARD SETTING	Forced stopping time setting	30 sec to 180 sec (1 sec increment)	
			PRESSURE	Protocol type selection	1.PAn 2.oth 3.Mod	
			FREQ (FREQUENCY)	Address setting	0: No communication (Setting at shipment) 1 to 49: Pan/oth 1 to 50: Mod	▲ pressing: Up the set value ▼ pressing: Down the set value
			SUC (SUCTION)	Operation mode	Fixed to "High resolution mode (FrE)"	Setting cannot be changed.
			DIS (DISCHARGE)	Fan operation mode	—	—
			ALM HISTORY	Operation sequence	Fixed to "No.1 compressor prioritized (nor)"	Setting cannot be changed.

Setting and Indication

Mode	DIP switch SW13-8	DIP switch SW13-7	Rotary switch (Knob) position	Display/Setup		Remarks
Back mode 2	OFF	ON	ON	High pressure/ Intermediate pressure/ Unit outlet pressure/ Low pressure display	High pressure: *** H (MPa) Intermediate pressure: *** c (MPa) Unit outlet pressure: *** o (MPa) Low pressure: *** (MPa)	▲ pressing: Increase the displayed value ▼ pressing: Reduce the displayed value
			OFF	Other temperature display (Suction, Unit outlet, Split cycle outlet, Gas cooler outlet)	**** (°C)	
			OPERATION MODE	Oil level display	Displays by "Lower limit"/ "Intermediate"/"Upper limit"	For details, refer to " Oil Level Control Method. "
			STANDARD SETTING	Electronic expansion valve opening display (Oil control)	MOV1: 1. *** (step) - - - : 2. 0 (fixed)	For detail, refer to " Oil Level Control Method. " ▲ pressing: Increase the displayed value ▼ pressing: Reduce the displayed value
			PRESSURE	Electronic expansion valve opening display (Pressure reduction, Gas return, Liquid return)	MOV5: 5. *** (step) MOV6: 6. *** (step) MOV7: 7. *** (step)	—
			FREQ (FREQUENCY)	Compressor current	**** (A)	—
			SUC (SUCTION)	Gas cooler fan speed	**** (rpm)	—
			DIS (DISCHARGE)	—	—	▲ pressing: Software Version ▼ pressing: Erase Alarm history
ALM HISTORY	Ambient temperature	**** (°C)	—			

Control Functions

Low Pressure Control Method

Compressor capacity is controlled by changing the inverter frequency based on the difference between the low pressure and set value by adjusting the low pressure to the set value (ON value to OFF value).

However, compressor operation continues even if the low pressure becomes below "OFF value" and finally stops when the low pressure reaches below the "Lim value".

$$* \text{ Lim value} = \text{OFF value} - \text{Diff value}$$

For the setting of Diff value, refer to "Low Pressure Setting" of "Setting and Indication".

Short Cycle Prevention Control

After the compressor has been stopped, and even the pressure becomes higher than the "ON value", stopping continues for the forced stopping time (30 to 180 sec).

Control Functions

Protective Functions

- (1) Power reverse/missing phase, high pressure abnormality, intermediate pressure abnormality, unit outlet pressure abnormality
Stops the compressor.
- (2) Discharge gas temperature abnormality
 1. Normal operation
Compressor operation stops when the discharge gas temperature exceeds 118 °C, and resumes when the discharge gas temperature becomes 75 °C.
 2. When abnormal discharge gas temperature occurs 3 times in 2 hours.
Compressor is made to stop even the discharge gas temperature becomes 75 °C.
For the method of resuming (resetting) compressor operation, refer to the "Description of Abnormality Alarm" in "About Alarms"
- (3) Refrigerant flood back abnormality
When the difference (suction gas superheat) between the suction gas temperature sensor value and evaporating temperature converted from the low pressure becomes 1 K or below for continuously 2 minutes, an error signal is indicated. During such condition, compressor operation continues.
Error indication is canceled when the suction gas superheat exceeds 5 K.
- (4) Sensor abnormality
 1. Open condition of low pressure, intermediate pressure sensor, unit outlet pressure sensor, high pressure sensor
Compressor stops with an error indication.
For the method of resuming (resetting) compressor operation, refer to the "Description of Abnormality Alarm" in "About Alarms"
 2. Open condition of discharge gas temperature sensor, gas cooler outlet temperature sensor, unit outlet temperature sensor, and ambient temperature sensor.
Compressor stops with an error indication.
For the method of resuming (resetting) compressor operation, refer to the "Description of Abnormality Alarm" in "About Alarms"
 3. Open condition of suction gas temperature sensor
Compressor stops with an error indication.
For the method of resuming (resetting) compressor operation, refer to the "Description of Abnormality Alarm" in "About Alarms".
- (5) Communication abnormality
While communication continues with the controller (external communication refrigerator No. is other than 0), if the controller data is not received for 10 minutes, then error is indicated. During such condition, compressor operation continues.
Error is canceled when data reception from the controller is resumed.

Caution

When the external communication refrigerator No. is set to other than 0 without connecting the controller, an error is displayed. Use caution.

Control Functions

- (6) Inverter abnormality
Compressor is stopped when abnormal operations which are indicated as section “About alarms” occurred. Refer to Inverter anomaly of section “About alarm” for detail.
- (7) Inverter communication abnormality
When the inverter V1000 or A1000 cannot receive data from the CR2-EN-PCB, compressor operation stops with error display.
For the method of resuming (resetting) compressor operation, refer to the “Description of Abnormality Alarm” in “About Alarms”

Defrosting Control

Operates defrosting control according to instructions from the controller. During the defrosting operation, the defrost (green) LED lights up and the compressor operation is stopped.

Adjustment during Operation

Avoiding Short Cycle Operations

Short cycle operation (frequent start/stop operation) causes excessive oil carry-over during starting and causes insufficient lubrication.

Adjust operation cycle to avoid short cycle operation. (Adjust ON-OFF cycle to be 10 minutes or longer.)

The main cause of short cycle operation is inappropriate pressure setting on CRD2-EN-PCB, suction filter clogging, and unbalance of cooling capacity and load.

When a cooling coil is used, incorrect attachment position of the compartment temperature sensor (cold air-blow directly hit the sensor) would become a problem in addition to the above. Review the sensor position.

Checking the Operation Condition of the Refrigeration Unit

- (1) Check abnormal vibration of the refrigeration unit and piping.
- (2) Check insufficient or excessive charging of refrigerant. (Check gas cooler outlet temperature and high pressure)
- (3) Check if the compressor oil quantity is appropriate. (Check with the digital display on the control PCB)
It normally takes several hours to several days for the oil level to stabilize, therefore requiring monitoring.
Adjust the oil quantity if it is insufficient or excessive.

[Method of checking oil level]

Set the rotary switch (knob) on the control PCB to [OPERATION MODE], and turn ON DIP switch SW13-7 to enter the oil level confirmation mode.

<Digital display example>



For details about checking the oil level, refer to the “Oil Level Control and Oil Addition Assessment Criteria” of “Oil Level Control Method.”

- (4) Check if the set value of the expansion valve (electronic expansion valve) and thermostat is appropriate.
- (5) Check whether or not liquid return operation is permitted. (Check superheat of suction gas temperature)

Adjustment during Operation

Adjusting Refrigerant Quantity of the Refrigeration Unit

During determination of refrigerant quantity, temperature setting of all Unit coolers/Display cases needs to be set to the lowest temperature without activation of the thermostat for making the refrigeration unit operating continuously.

(1) Method of determining refrigerant quantity

Check the operation condition of the refrigeration unit by the following method, and adjust the refrigerant quantity to the appropriate value according to Table 3 (Determination criteria of refrigerant quantity).

- 1) Check that the suction gas temperature is 18°C or below.
- 2) Check that the superheat of the suction gas temperature is 10 K or greater.
- 3) Check if the high pressure has been set to the standard high pressure (Table 2).
- 4) Check if the gas cooler outlet temperature is +2 K to +5 K for the ambient temperature.

The method of checking each temperature and pressure should comply with Table 1 and the value should be confirmed with the digital display.

Table 1 Method of checking each temperature and pressure

Reference item	DIP switch SW13	Rotary switch (knob) SW 11
Suction gas temperature	SW13-2 ON (all other OFF)	SUC
High pressure	SW13-2 ON (all other OFF)	PRESSURE
Gas cooler outlet temperature	SW13-2 and 7 ON (other OFF)	OFF (Press ▲ 3 times)

Table 2 Standard high pressure

Ambient temperature	Evaporating temperature $\leq -20^\circ\text{C}$	Evaporating temperature $> -20^\circ\text{C}$
	High pressure	High pressure
0 °C or below	3.4MPa	3.4MPa
5 °C	3.9MPa	3.9MPa
10 °C	4.4MPa	4.4MPa
15 °C	5.0MPa	5.0MPa
20 °C	5.6MPa	5.8MPa
25 °C	7.5MPa	8.0MPa
30 °C	8.5MPa	9.0MPa
35 °C	9.1MPa	9.6MPa

Table 3 Determination criteria of refrigerant quantity

Gas cooler outlet temperature	Less than "Ambient temperature +2 K"	"Ambient temperature +2 K" to "Ambient temperature +5 K"	Greater than "Ambient temperature +5 K"
High pressure			
High	▲	▲	○
Standard	○	◎	▽
Low	▽	▽	▽

▲: Refrigerant overcharge, ◎: Appropriate, ▽: Refrigerant shortage, ○: Perform continuous operation and monitor the condition.

(2) Refrigerant quantity adjustment

1) Shortage of refrigerant (when charging additional refrigerant)

- Perform cooling operation and charge additional refrigerant via the access port of the low pressure service valve.
- Adjust valve opening during slow charging operation to avoid frosting beyond the refrigerant service valve.
- Guideline of charging rate of refrigerant is 20 g per 5 seconds.

Note: Rapid refrigerant charging may lead to a compressor failure.

2) Overcharging of refrigerant (when releasing the refrigerant)

- Release the refrigerant via the access port of the low pressure service valve.
- Open the valve very slowly. Use caution for oil leak out.
- As CO₂ refrigerant is heavier to air, use caution for gas stagnation.

3) After completing refrigerant adjustment, close the access port of the low pressure service valve.

Caution

Shortage of refrigerant tends to cause lower level of high pressure and higher level of intermediate pressure.

Oil Level Control Method

Oil Level Control and Oil Addition Assessment Criteria

When the connection piping is long, oil in the refrigeration unit tends to attach to the inner surface of the piping, resulting in insufficient oil in the compressor. When the piping length exceeds 50 m, add oil according to the table below.

Connected pipe length	Additional oil quantity (per refrigeration unit)
50 m or below	0.0 L
More than 50 m but 100 m or below	1.0 L

After adding the oil quantity shown above, check the oil level and adjust oil addition while operating the refrigeration unit.

(1) Checking the change of oil level

Set the rotary switch (knob) on the control PCB to [OPERATION MODE], and turn ON the DIP switch SW13-7 to enter the oil level confirmation mode.

< Digital display example (Oil level) > (E.g.) Oil level upper limit indication

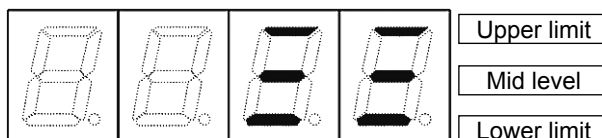

[Checking method]

During continuous operation of the refrigeration unit, confirm whether the oil quantity is appropriate by checking the oil level indicated by the digital display. (Exclude the initial start-up time)

• Correct operation

The oil level generally stays between “Lower limit - Mid level - Upper limit”, and no Oil level anomaly (E391) is occurred.

(E.g.) 1) Changing as Lower → Mid level → Upper → Mid level → Lower → Mid level.

2) Changing as Lower → Mid level → Upper → Mid level → Upper → Mid level.

Note: The time of change varies according to the operation condition.

• Abnormal motion (Insufficient oil supply)

1) The oil level does not recover from the lower limit position.

2) Lower limit condition continued for 10 minutes, and “Oil level anomaly (E391)” occurred. (Stop the compressor)

(2) Check the degree of opening of the oil control electronic expansion valve (MOV1)

Set the rotary switch (knob) on the control PCB to [STANDARD SETTING] position and turn ON the DIP switch SW13-7. Press ▲ and ▼ to indicate “1” in the digital display and display the opening of the oil control electronic expansion valve.

< Digital display example >

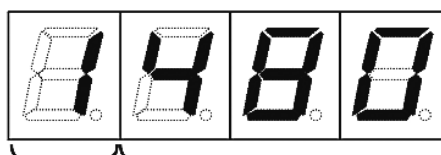

(E.g.) Electronic expansion valve opening 480 steps

By operating ▲▼ (up and down switch), set to “1”.

Electronic expansion valve opening Display range (30 to 480 steps)

Oil Level Control Method

Oil Level Control and Oil Addition Assessment Criteria

[Checking method]

During continuous operation of the refrigeration unit, check for any variations of the oil control electronic expansion valve opening by using the digital display.

• Correct operation

The electronic expansion valve opening generally stays between “small opening” and “medium opening” without occurring “Oil level anomaly (E391)”.

(E.g.) 1) 120 → 240 → 360 → 240 → 120 Moves up and down in a relatively short time including “large opening”, but promptly goes down.

2) 90 → 120 → 150 → 120 → 90 Maintains a relatively “small opening”.

• Abnormal motion (Insufficient oil supply)

- 1) The electronic expansion valve opening stays around the large opening (480 steps).
- 2) The electronic expansion valve opening frequently reaches the large opening (480 steps).
- 3) “Oil level anomaly (E391)” occurs. (Stop the compressor)

(3) Adding oil

Add oil when the following condition is confirmed.

- 1) When the oil level checked by the item “(1) Checking the change of oil level” stays near the lower limit.
- 2) When the electronic expansion valve opening checked by the item “(2) Check the degree of opening of the oil control electronic expansion valve” was confirmed to stay at the large opening (480 steps) or near the upper limit of the “large opening”.
- 3) “Oil level anomaly (E391)” occurs.

Caution

The oil addition assessment shown above is based on the condition that no clogging exists in the oil control electronic expansion valve (MOV1) or strainer in the Caution refrigerant circuit.

Oil Level Control Method

Oil Replenishing Method

For the detailed method of adding oil, refer to the Engineering Service Manual “Compressor Oil Adding Procedure.”

- (1) Turn the ground fault interrupter and operation switch S1 to “OFF” to stop the operation of the refrigeration unit.
- (2) Confirm that the access ports of the high pressure / low pressure service valves and oil service valve are closed (back seated position), and connect service piping (SPK-TU127 and SPK-TU126) with an attached (closed) joint valve to each access port.
<High pressure / Low pressure service valve: Connect SPK-TU127, Oil service valve: Connect SPK-TU126>
- (3) Before adding oil, the refrigerant in the refrigerant circuit needs to be released. By using the following procedure, enter “Evacuation mode” (electronic expansion valve and solenoid valve are open).

- [1] While keeping the ground fault interrupter “OFF,” turn operation switch S1 to “ON.”
- [2] Turn ON the DIP switch SW13-1 on the control PCB, and set the slide switch SW15 to [CHECK] and then turn ON the ground fault interrupter.
- [3] The digital display sequentially indicates “Low pressure→High pressure→Unit outlet pressure→uAcU” and the electronic expansion valve and solenoid valve will open.



- (4) Set the high pressure / low-pressure service valves slowly open the joint valve attached to the service piping to release the refrigerant in the refrigerant circuit. After releasing the refrigerant, connect an extension pipe (copper pipe or charging hose) to the joint valve of the oil service valve.

Caution

When setting each service valve to the front seat, recheck in advance that there are no loose connections in the nut of each service valve, or in the joint of the service piping.
A loose nut or pipe joint may cause the refrigerant to leak out.

- (5) Set the rotary switch (knob) to [OPERATION MODE] and turn ON the DIP switch SW13-7 for activating “Oil level confirmation mode.” Next, connect the manifold gauge set exclusively for CO₂ refrigerant and vacuum pump to the service piping attached to the high pressure / low pressure service valves, and set the oil service valve to open seat position while applying evacuation, open the joint valve to suck up oil and add oil until the oil level reaches the upper limit.

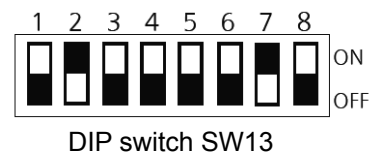

<Digital display example> (E.g.) Oil level indication before and after adding oil

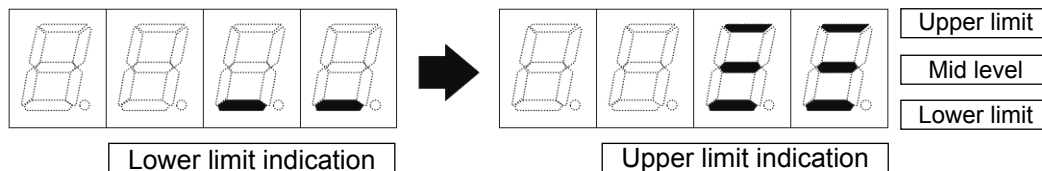

Oil Level Control Method

Oil Replenishing Method

- (6) After adding oil, close the joint valve of the oil service valve and remove the extension pipe, and continue evacuation from the high pressure / low pressure service valves. (Continue until reaching vacuum level of 133 Pa (1 Torr) and further continue for one to three hours)
- (7) After applying evacuation, turn OFF the operation switch S1 and then return the slide switch SW15 to [CONTROL] and the DIP switch SW13-1 to "OFF".
Next, return the DIP switch SW13-7 to "OFF" and the rotary switch (knob) to [OPERATION].
- (8) After removing the vacuum pump, connect a refrigerant cylinder to the manifold gauge set, and charge the refrigerant from the high pressure service valve in liquid state. When liquid refrigerant can no longer be added, close the access port of the high pressure service valve, activate the refrigeration unit's cooling operation to adjust the refrigeration quantity from the access port of the low pressure service valve.

Caution

- [1] You must not charge liquid refrigerant from the access port of the low pressure service valve under any circumstances.
- [2] For adjustment of the refrigerant quantity, follow instructions in "Adjusting Refrigerant Quantity of the Refrigeration Unit" in "Adjustment during Operation."

- (9) After completing the refrigerant quantity adjustment, close the valve of the refrigerant cylinder and access port of the low pressure service valve, and then slowly open the purge valve of the manifold gauge set to release the remaining refrigerant in the service piping and manifold gauge set.
- (10) After completely releasing the refrigerant in the pipes, remove the service piping and attach a nut at the access port (fastening torque: 13 ± 1 N·m). At the end of operations, check for a loose gland nut (fastening torque: 10 ± 1 N·m) at each service valve and fasten again, and then attach the cap (fastening torque: 30 ± 5 N·m).

About Alarms

Installation of an Alarm System

This refrigeration unit has a variety of protection devices for securing safety. When the ground fault protector or other protection device is activated, and the alarm system or temperature control system is insufficient, cooling operation is stopped for many hours thereby damaging the food items.

To enable prompt actions at such time, an alarm system or temperature control system should be considered at the time of plan development.

External Alarms

This refrigeration unit is capable of delivering alarm output during abnormality (no voltage contact: contact capacity Maximum 250V 3A).

During unit abnormality, the alarm output between the External alarm terminal base 1 and base 2 is turned ON (continuity between the contacts). Connection of an external alarm circuit (local wiring) is recommended. External alarm power should be furnished separately from the refrigeration unit power.

Detail of abnormality alarm content is shown in the table below.

External alarm terminal base

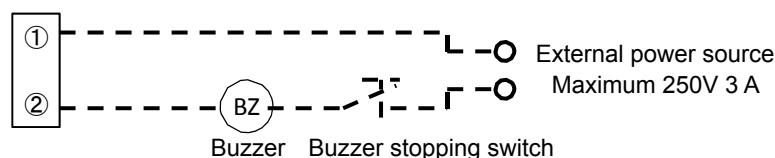

About Alarms

Description of Abnormality Alarm

When the ground fault protector is activated, check insulation of the equipment and circuit, eliminate the cause, and then supply power again.

	Anomaly item									Note
	Number of times to automatically restart	When restarting				When stopped				
		Alarm indication		External alarm signal	Communication signal	Alarm indication		External alarm signal	Communication signal	
		ALARM (Red) LED	Error code			ALARM (Red) LED	Error code			
High pressure anomaly	6	blinking	E311	none	none	lighting	E011	output	output	1)
Discharge gas temperature anomaly	2	blinking	E101	none	none	lighting	E031	output	output	2)
Discharge gas temperature sensor anomaly	None	-	-	-	-	lighting	E041	output	output	
Low pressure sensor anomaly	None	-	-	-	-	lighting	E05	output	output	
High pressure sensor anomaly	None	-	-	-	-	lighting	E06	output	output	
Suction gas temperature sensor anomaly	None	-	-	-	-	OFF	E07	none	none	
Oil level anomaly	1	blinking	E391	none	none	lighting	E091	output	output	3)
Inverter communication anomaly	None	-	-	-	-	lighting	E181 E183	output	output	
Controller communication anomaly	None	-	-	-	-	OFF	E19	none	none	
Radiator temperature anomaly	None	-	-	-	-	lighting	E201	output	output	
Radiator temperature anomaly	None	-	-	-	-	lighting	E221	output	output	
Ambient temperature sensor anomaly	None	-	-	-	-	lighting	E23	output	output	
Gas cooler fan motor anomaly	None	-	-	-	-	OFF	E271	none	none	4)
Refrigerant flood back alarm	None	-	-	-	-	OFF	E32	none	none	5)
Intermediate pressure anomaly	6	blinking	E36	none	none	lighting	E46	output	output	
Unit outlet pressure anomaly	6	blinking	E37	none	none	lighting	E47	output	output	
Intermediate pressure sensor anomaly	None	-	-	-	-	lighting	E81	output	output	
Unit outlet temperature sensor anomaly	None	-	-	-	-	lighting	E57	output	output	
Gas cooler outlet temperature sensor anomaly	None	-	-	-	-	lighting	E59	output	output	
Split cycle outlet temperature sensor anomaly	None	-	-	-	-	lighting	E80	output	output	
Oil level switch anomaly	None	-	-	-	-	lighting	E851	output	output	
Unit outlet pressure sensor anomaly	None	-	-	-	-	lighting	E88	output	output	
Refrigerant over charge	-	blinking	E84	none	none	-	-	-	-	

※ Reset method when stopped.

Operate either ground fault interrupter, operation switch, or controller.

1) After stopping for 5 min, then "auto recovery".

2) Restart when the discharge gas temperature becomes 75°C or below.

3) After stopping for 1 min, then "auto recovery".

4) After stopping for 60 min, then "auto recovery".

5) Auto recovery when the difference between the evaporating temperature and suction gas temperature is 5K or greater.

About Alarms

		Inverter anomaly item							
		When 1st and 2nd incident are automatically restore				When 3rd incident is stop			
	Inverter	Error code	ALARM (Red) LED	External alarm signal	Communication signal	Error code	ALARM (Red) LED	External alarm signal	Communication signal
DC Bus Undervoltage(Uv1)	A1000	E671	blinking	none	none	E771	lighting	output	output
	V1000	E673	blinking	none	none	E773	lighting	output	output
Control Power Supply Voltage Fault(Uv2)	A1000	E651	blinking	none	none	E751	lighting	output	output
	V1000	E653	blinking	none	none	E753	lighting	output	output
Undervoltage(Uv3)	A1000	E681	blinking	none	none	E781	lighting	output	output
	V1000	E683	blinking	none	none	E783	lighting	output	output
Output Short-Circuit or IGBT Fault(SC)	A1000	E611	blinking	none	none	E711	lighting	output	output
	V1000	E613	blinking	none	none	E713	lighting	output	output
Ground Fault(GF)	A1000	E611	blinking	none	none	E711	lighting	output	output
	V1000	E613	blinking	none	none	E713	lighting	output	output
Overcurrent (oC)	A1000	E621	blinking	none	none	E721	lighting	output	output
	V1000	E623	blinking	none	none	E723	lighting	output	output
Drive Overheat Warning (ov)	A1000	E651	blinking	none	none	E751	lighting	output	output
	V1000	E653	blinking	none	none	E753	lighting	output	output
Heatsink Overheat (oH)	A1000	E631	blinking	none	none	E731	lighting	output	output
	V1000	E633	blinking	none	none	E733	lighting	output	output
Overheat 1 (oH1)	A1000	E631	blinking	none	none	E731	lighting	output	output
	V1000	E633	blinking	none	none	E733	lighting	output	output
Motor Overload (oL1)	A1000	E601	blinking	none	none	E701	lighting	output	output
	V1000	E603	blinking	none	none	E703	lighting	output	output
Drive Overload (oL2)	A1000	E641	blinking	none	none	E741	lighting	output	output
	V1000	E643	blinking	none	none	E743	lighting	output	output
Overtorque Detection 1 (oL3)	A1000	E601	blinking	none	none	E701	lighting	output	output
	V1000	E603	blinking	none	none	E703	lighting	output	output
Overtorque Detection 2 (oL4)	A1000	E601	blinking	none	none	E701	lighting	output	output
	V1000	E603	blinking	none	none	E703	lighting	output	output
Dynamic Braking Transistor (rr)	A1000	E601	blinking	none	none	E701	lighting	output	output
	V1000	E603	blinking	none	none	E703	lighting	output	output
Output Current Imbalance (LF2)	A1000	E601	blinking	none	none	E701	lighting	output	output
	V1000	E603	blinking	none	none	E703	lighting	output	output
Pullout Detection (Sto)	A1000	E661	blinking	none	none	E761	lighting	output	output
	V1000	E663	blinking	none	none	E763	lighting	output	output
LSo Fault (LSo)	A1000	E661	blinking	none	none	E761	lighting	output	output
	V1000	E663	blinking	none	none	E763	lighting	output	output
Output Voltage Detection Fault (voF)	A1000	E691	blinking	none	none	E791	lighting	output	output
	V1000	E693	blinking	none	none	E793	lighting	output	output
Input Phase Loss (PF)	A1000	E651	blinking	none	none	E751	lighting	output	output
	V1000	E653	blinking	none	none	E753	lighting	output	output
Others	A1000	E601	blinking	none	none	E701	lighting	output	output
	V1000	E603	blinking	none	none	E703	lighting	output	output

※ Reset method when stopped
Operate either ground fault interrupter, operation switch, or controller.

Maintenance and Inspection

Maintenance and inspection should be contacted with a specialty company.
All work must be conducted by authorized and licensed technicians.

Request for Maintenance and Inspection (To a specialty company for installation work)

The structural components of refrigeration unit do not last permanently but include those wearing out in a certain period of time.

In order to prevent accidents before they occur, those components need to be inspected periodically before reaching their service life and replaced.

Installation company needs to contract with the equipment user for performing scheduled inspection of the equipment including the cooling system.

Service Parts and Replacement Guidelines

Major components requiring inspection and replacement in a refrigeration unit along with their frequency of inspection and replacement are shown below. When any abnormality is detected by inspection, replace it early. As to the engineering detail for inspection and replacement, refer to "Engineering Service Manual" issued by our company. Inspection and replacement timing vary by operation rate and condition, ambient environment, and individual component condition and cannot uniformly be determined. We request full inspection particularly at (1) Commissioning, (2) Scheduled inspection, (3) System maintenance, etc.

Inspection items/Replacement parts		Inspection content/Replacement guideline
System overall (Each part temperature)		(1) Pressure condition should match the cooling temperature (2) Temperature of each part must be normal (3) No abnormality exists in the installed condition.
Compressor	Abnormal sound, abnormal vibration	No abnormal sound or abnormal vibration should be generated.
Gas cooler	Fin clogging	Is the fin clogged with dust ? ... Scheduled cleaning
	Fan rotation	Is there any abnormality in the fan rotation ?
Piping component	Filter dryer	Replace the filter dryer for clogging, deformation, or large temperature and/or large pressure differences between the dryer inlet and outlet.
	Suction filter	Replace the Suction filter for clogging, deformation, or large temperature and/or large pressure differences (abnormally low pressure) between the filter inlet and outlet.
	Other piping positions	Refrigerant leak, oil leak, deformation, abnormal vibration, deterioration of heat insulation material
Electrical components	Fan motor	Replace when generating abnormal sound, heavy in rotation, oil smearing, etc.
	Activation of protection device and control component	Replace when control failure by motion defect, chattering etc.
	Terminal, wiring, etc.	Any change of color, deterioration of insulation
	Electrical box air filter	Clean the filter periodically (every 3 to 6 months) according to the contamination.

Actions at the time of Failure

When a component failure or malfunction is found, request the specialty company to repair.

Actions at the time of Failure

When the refrigeration unit or any refrigerant circuit component fails to operate by some reason, turn off the power for a repair.

To avoid failure recurrence, use caution for the following.

- (1) To avoid recurrence of the same failure, execute reliable failure diagnosis and identify the true cause before starting a repair.
When the ground fault protector is activated, check insulation of the equipment and circuit, eliminate the cause, and then supply power gain.
- (2) When the piping is to be corrected, be sure to release refrigerant from the welded point, and perform welding while flowing nitrogen gas.
- (3) When replacing the major component such as compressor, gas cooler, or refrigerant and oil, always replace the filter dryer.
When the refrigerant circuit is contaminated by burnt compressor motor, etc. apply nitrogen blow to eliminate refrigeration oil remaining in the refrigerant circuit.
(At such time, also remove the expansion valve (electronic expansion valve))
- (4) When replacing the compressor, do not apply power to the crankcase heater while it is removed from the compressor. Be sure to shut off the power. (It may lead to fire)
- (5) To avoid current leak accident, install the components (cover, electric parts, etc.) removed during inspection and service and attach them as they were originally.
- (6) Replace the filter circuit board (FIL2-EN-PCB) as a whole when the fuse is broken.
- (7) When the digital display (LED) on the control PCB does not operate with the power supplied, check the following.

Caution Always check after shutting off the power.

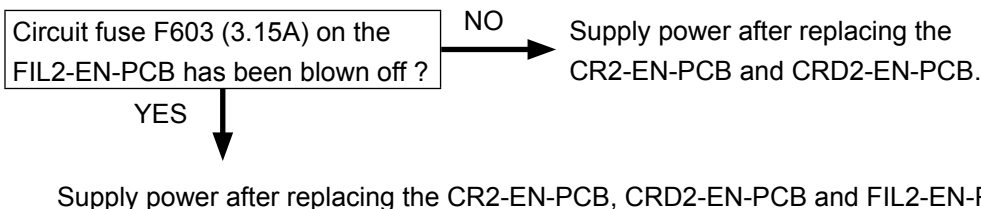

When the failure cause is unknown, contact our service office with the failure symptom, model number, manufacturing code, etc.

Actions at the time of Failure

Replacing the Compressor

Before replacing the compressor, refer to the Engineering Service Manual "Compressor Replacement Procedure"

Caution

- (1) Be sure to shut off the ground fault protector. (Operation switch OFF does not shut off the crankcase heater.)
- (2) Connect compressor terminals U, V, and W with each lead wire as connected before. (For avoiding phase inversion)
U —Red, V —White, W —Black
- (3) Install the crankcase heater at the specified position tightly contacting the compressor.
- (4) Apply evacuation from both the high pressure and low pressure service valves.

Method of Clearing Alarm History

Operate the rotary switch (knob) and DIP switch.

- (1) Align the rotary switch (knob) with [DIS]. (Discharge gas temperature is displayed)
- (2) Turn ON the DIP switch SW13-7.
- (3) Press ▼ button. (Entire content of [ALM HISTORY] is cleared.)
- (4) Turn OFF the DIP switch SW13-7.
- (5) Align the rotary switch (knob) with [ALM HISTORY] and confirm that [E - -] is displayed, indicating that the content has been cleared.
- (6) Set the rotary switch (knob) back to [OPERATION] position.

Failure Diagnosis

Error Code

(1) When the rotary switch (knob) is at [OPERATION] position, the digital display on the control PCB alternately displays low pressure, high pressure and error code (E ***).

< Error Code Table >

Error code	Meaning	Cause	Correction method
E011	High pressure anomaly (7th incident)	Increased high pressure caused a high pressure anomaly.	(1) Investigate the cause of high pressure anomaly. (2) Check for the presence of any anomalies of the high pressure sensor.
E031	Discharge gas temperature anomaly (3rd incident)	Abnormal stop caused by increased discharge temperature to 118°C or higher occurred three times in two hours.	Follow the procedure shown in "Failure Diagnosis at the time of Abnormal Discharge Gas Temperature." (1) Search for the cause of increasing discharge gas temperature. (2) Check the connection of control PCB "2P4 discharge 1 connector." (3) Check the resistance value of the discharge gas temperature sensor (Refer to "Method of Checking Sensor Characteristics").
E041	Discharge gas temperature sensor anomaly	Discharge gas temperature sensor became abnormal (open circuit condition).	(1) Check the connection of control PCB "2P4 discharge 1 connector." (2) Check the resistance value of the discharge gas temperature sensor (Refer to "Method of Checking Sensor Characteristics").
E05	Low pressure sensor anomaly	Low pressure sensor became abnormal (open circuit condition).	(1) Check the connection of control PCB "3P1 low pressure connector." (2) Check the output voltage of the low pressure sensor (Refer to "Method of Checking Sensor Characteristics").
E06	High pressure sensor anomaly	High pressure sensor became abnormal (open circuit condition).	(1) Check the connection of control PCB "3P3 high pressure connector." (2) Check the output voltage of the high pressure sensor (Refer to "Method of Checking Sensor Characteristics").
E07	Suction gas temperature sensor anomaly	Suction gas temperature sensor became abnormal (open circuit condition).	(1) Check the connection of control PCB "2P9 U inlet connector." (2) Check the resistance value of the suction gas temperature sensor (Refer to "Method of Checking Sensor Characteristics").
E091	Oil level anomaly	Low oil level condition continued for 10 min.	(1) Investigate the cause of oil level anomaly. (2) Check the connection of control PCB "6P11 electronic expansion valve 1 connector." (3) Check the coil attachment condition and resistance value of the oil control electronic expansion valve (MOV1). When checking, refer to "Method of Checking the Resistance of Electronic Expansion Valve Coil and Oil Level Switch." (4) Check the oil level and add oil according to the "Oil Level Control Method."
E101	Discharge gas temperature anomaly (1st to 2nd incident)	Discharge gas temperature increased to 118°C or higher and generated an abnormal stop. Or discharge gas temperature sensor shorted.	Comply with the "Failure Diagnosis at the time of Abnormal Discharge Gas Temperature." (1) Search for the cause of increasing discharge gas temperature. (2) Check the connection of control PCB "2P4 discharge 1 connector." (3) Check the resistance value of the discharge gas temperature sensor (Refer to "Method of Checking Sensor Characteristics").
E181, E183	Inverter communication anomaly	No serial communication signal between "control PCB" and "Inverter"	Check the communication line between control PCB "5P1 connector" and Inverter A1000/V1000 connector."
E19	Controller communication anomaly	No controller signal exists in communication.	(1) Check the communication line (control PCB "5P4, 5P5 connector"). (2) Set the communicating refrigeration unit No. to a value other than "0."
E201	Radiator temperature anomaly	Inverter radiator temperature increased to 100°C or higher and stopped abnormally.	(1) Investigate the cause of the increasing radiator temperature. (2) Check the connection of control PCB "2P31 Cooler 1 connector." (3) Check the resistance value of the radiator temperature sensor (Refer to "Method of Checking Sensor Characteristics").
E221	Radiator temperature sensor anomaly	Radiator temperature sensor became abnormal (open circuit condition).	(1) Check the connection of control PCB "2P31 Cooler 1 connector." (2) Check the resistance value of the radiator temperature sensor (Refer to "Method of Checking Sensor Characteristics").
E23	Ambient temperature sensor anomaly	Ambient temperature sensor became abnormal (open circuit condition).	(1) Check the connection of control PCB "2P8 ambient air connector." (2) Check the resistance value of the ambient temperature sensor (Refer to "Method of Checking Sensor Characteristics").
E271	Gas cooler fan motor anomaly	Gas cooler fan motor became abnormal. (The fan rotation speed significantly deviated from the set rotation speed.)	(1) Check for the presence of a fan lock, fan dislocation, etc.
E311	High pressure anomaly (1st to 6th incident)	Increased high pressure caused a high pressure anomaly.	(1) Investigate the cause of high pressure anomaly. (2) Check for the presence of any anomalies of the high pressure sensor.
E32	Refrigerant flood back alarm	Suction gas superheat (difference between "suction gas temperature" and "evaporating temperature calculated from low pressure") became 1 K or below continuously for 2 min.	Check the cause of refrigerant flood back operation.
E36	Intermediate pressure anomaly (1st to 6th incident)	Increased intermediate pressure caused an abnormal intermediate pressure.	(1) Investigate the cause of intermediate pressure anomaly. (2) Check for the presence of any anomalies of the intermediate pressure sensor.

Failure Diagnosis

Error Code

Error code	Meaning	Cause	Correction method
E37	Unit outlet pressure anomaly (1st to 6th incident)	Increased unit outlet pressure caused a unit outlet pressure anomaly.	(1) Investigate the cause of unit outlet pressure anomaly. (2) Check for the presence of any anomalies of the unit outlet pressure sensor.
E46	Intermediate pressure anomaly (7th incident)	Increased intermediate pressure caused an intermediate pressure anomaly.	(1) Investigate the cause of intermediate pressure anomaly. (2) Check for the presence of any anomalies of the intermediate pressure sensor.
E47	Unit outlet pressure anomaly (7th incident)	Increased unit outlet pressure caused a unit outlet pressure anomaly.	(1) Investigate the cause of unit outlet pressure anomaly. (2) Check for the presence of any anomalies of the unit outlet pressure sensor.
E57	Unit outlet sensor anomaly	Unit outlet temperature sensor became abnormal (open circuit condition).	(1) Check the connection of control PCB "2P5 U outlet connector." (2) Check the resistance value of the unit outlet temperature sensor (Refer to "Method of Checking Sensor Characteristics").
E59	Gas cooler outlet temperature sensor anomaly	Gas cooler outlet temperature sensor became abnormal (open circuit condition).	(1) Check the connection of control PCB "2P6 GC outlet connector." (2) Check the resistance value of the gas cooler outlet temperature sensor (Refer to "Method of Checking Sensor Characteristics").
E6X1 ~E7X1, E6X3 ~E7X3	Inverter anomaly	The inverter operation became abnormal.	Comply with the "Failure Diagnosis of Inverter Unit." (1) Check if Power source is connected to power source terminal base. (2) Confirm whether an overload operation is taking place. (3) Check for gas cooler fan motor anomalies (E271) . (4) Check for the presence of a power source voltage drop or power missing phase. (5) Check if the compressor is locked. (6) Check if inverter A1000 output is connected to compressor. (7) Check if inverter V1000 output is connected to fan motor.
E80	Split cycle outlet temperature sensor anomaly	Split cycle outlet temperature sensor became abnormal (open circuit condition).	(1) Check the connection of control PCB "2P7 S outlet connector." (2) Check the resistance value of the split cycle outlet temperature sensor (Refer to "Method of Checking Sensor Characteristics").
E81	Intermediate pressure sensor anomaly	Intermediate pressure sensor became abnormal (open circuit condition).	(1) Check the connection of control PCB "3P2 intermediate pressure connector." (2) Check the output voltage of the intermediate pressure sensor (Refer to "Method of Checking the Resistance of Electronic Expansion Valve Coil and Oil Level Switch").
E851	Oil level switch anomaly	Oil level switch became abnormal. (Both top contact and bottom contact became short-circuited at the same time.)	(1) Check the connection of control PCB "3P22 oil level 1 connector." (2) Check the resistance value of the oil level switch. When checking, refer to "Method of Checking the Resistance of Electronic Expansion Valve Coil and Oil Level Switch."
E88	Unit outlet pressure sensor anomaly	Unit outlet pressure sensor became abnormal (open circuit condition).	(1) Check the connection of control PCB "3P4 U outlet connector." (2) Check the output voltage of the unit outlet pressure sensor (Refer to "Method of Checking Sensor Characteristics").

Indication	Meaning	Correction method	Remarks
Alarm (red) LED blinks	Anomaly that occurred in the past. Up to 50 past error codes are saved in the "Alarm History."	Check the error code in the table above and eliminate the cause. Then, align the rotary switch (knob) to "Operation," and press ▲ or turn the operation switch "OFF." Then, LED stops blinking.	
Digital display "-CH-"	Control PCB is in the check mode.	Set control PCB slide switch SW15 to "Control."	Set control PCB slide switch SW15 to "Check," and DIP switch SW13-1 and SW13-6 to "ON" and supply power to enter the check mode.

Failure Diagnosis

Failure Diagnosis at the time of Abnormal Discharge Gas Temperature

When the discharge gas temperature goes up abnormally, compressor is stopped for protecting the compression components of the compressor and discharge gas temperature abnormality alarm is generated at the same time. In such a case, check the problem position and apply appropriate actions in the sequence shown below.

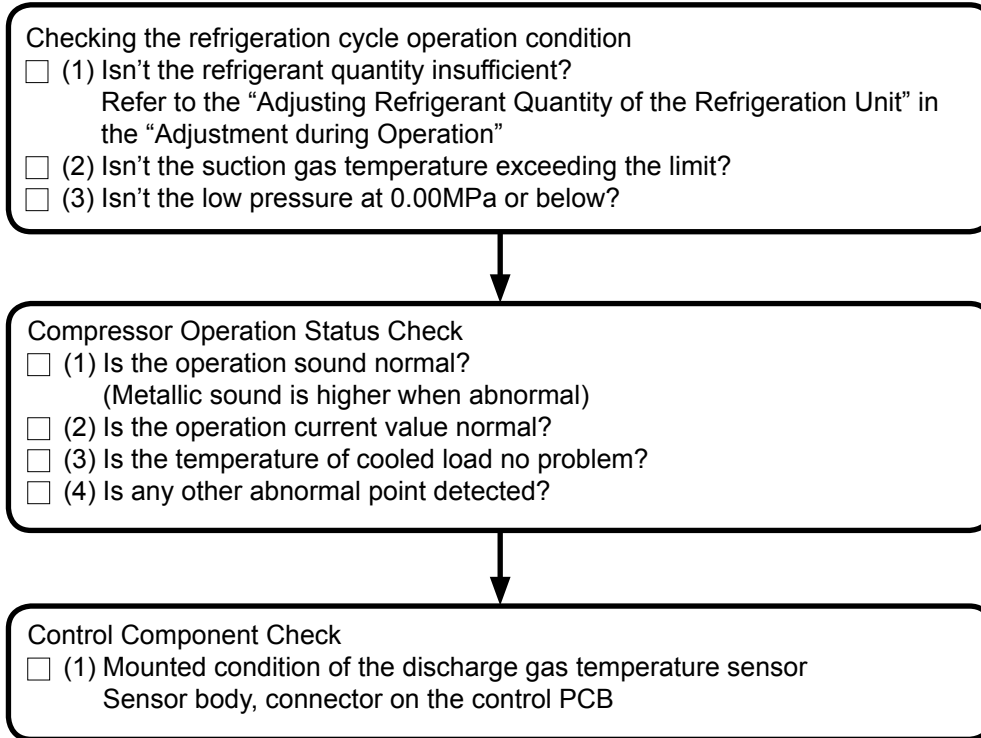

Failure Diagnosis of Gas Cooler Fan

(1) When the ground fault protector shuts OFF.

1. Check the insulation resistance between each terminal of the power supply unit, fan motor inverter (Inverter V1000) and the ground (G terminal).
..... When the insulation resistance is 1 M Ω or below, insulation failure exists in the Inverter V1000 or fan motor.
2. Disconnect the fan motor lead wire from the Inverter V1000 and check the insulation resistance between the ground.
..... When the insulation resistance is 1 M Ω or below, insulation failure exists in the fan motor.

(2) When the fan motor does not rotate normally.

1. While the fan motor is powered, it does not rotate smoothly (stopping or uneven rotation) or generates roaring noise.
..... Fan motor bearing failure is the cause.

Failure Diagnosis

Method of Checking Sensor Characteristics

(1) Pressure (Low, Intermediate, Unit outlet, High pressure) sensor

While the connector is inserted to the control PCB, measure the voltage and check if the pressure is normal by using the table below.

< Relationship between sensor output voltage and pressure >

Pressure (MPa)	0.00	1.00	2.00	3.00	4.00	5.00	6.00	7.00	8.00	9.00	10.00	11.00	12.00
Voltage (DCV)	0.50	0.77	1.03	1.30	1.57	1.83	2.10	2.37	2.63	2.90	3.17	3.43	3.70

* In the table above, when the pressure value is an intermediate value such as 4.5MPa, use a proportional calculation.

Caution

When checking the voltage of a pressure sensor, always use DCV range of the tester. Use caution, measurement by using resistance range may cause a sensor failure.

[Voltage measurement method]

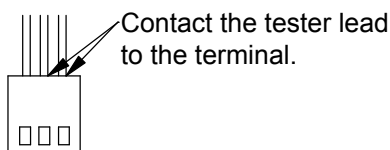

[CR2-EN-PCB]

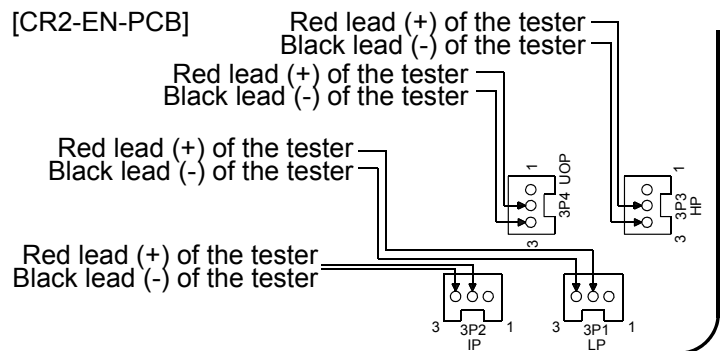

(2) Suction gas temperature sensor, Gas cooler outlet temperature sensor

Measure the resistance while the connector is disconnected from the control PCB, and check if the temperature is normal by using the following table.

< Relationship between sensor temperature and resistance value >

Temperature (°C)	-50	-40	-30	-20	-10	0	10	20	30
Resistance value (kΩ)	77.58	43.34	25.17	15.13	9.39	6.00	3.94	2.64	1.82

[Resistance measurement method]

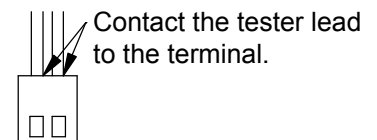

* In the table above, when the temperature is an intermediate value such as -5 °C, use a proportional calculation.

(3) Discharge gas temperature sensor

Measure the resistance while the connector is disconnected from the control PCB, and check if the temperature is normal by using the following table.

< Relationship between sensor temperature and resistance value >

Temperature (°C)	20	30	40	50	60	70	80	90	100	110	120
Resistance value (kΩ)	70.13	45.05	29.67	20.00	13.79	9.71	6.97	5.09	3.77	2.84	2.16

* In the table above, when the temperature is an intermediate value such as 65 °C, use a proportional calculation.

(4) Other temperature sensors (unit outlet, ambient, split outlet temperature.)

Measure the resistance while the connector is disconnected from the control PCB, and check if the temperature is normal by using the following table.

< Relationship between sensor temperature and resistance value >

Temperature (°C)	-10	0	10	20	30	40	50	60	70
Resistance value (kΩ)	26.22	15.76	9.76	6.21	4.05	2.70	1.84	1.28	0.90

* In the table above, when the temperature is an intermediate value such as 35 °C, use a proportional calculation.

Failure Diagnosis

Method of Checking the Resistance of Electronic Expansion Valve Coil and Oil Level Switch

- (1) Electronic expansion valve coil: Used in Oil control electronic expansion valve (MOV1), Electronic expansion valve for pressure reduction (MOV5), Electronic expansion valve for gas return (MOV6) and Electronic expansion valve for liquid return (MOV7)

Measure the resistance with the connector disconnected from the control PCB, and check if the resistance value is normal level by using the table below.

Measurement Position	Resistance Value
Between connector 1-6	185 Ω ± 18 Ω
Between connector 2-6	185 Ω ± 18 Ω
Between connector 3-6	185 Ω ± 18 Ω
Between connector 4-6	185 Ω ± 18 Ω

Note: Ambient temperature 20°C

[Resistance measurement method]

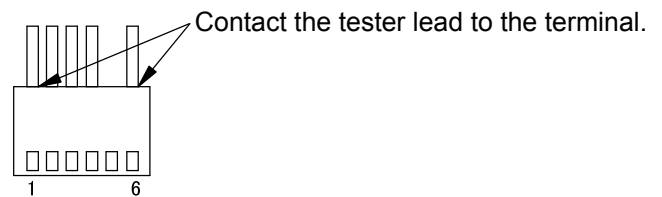

< Electronic expansion valve connector >

6P11: Oil control electronic expansion valve (MOV1)

6P13: Electronic expansion valve for pressure reduction (MOV5)

6P14: Electronic expansion valve for gas return (MOV6)

6P15: Electronic expansion valve for liquid return (MOV7)

Caution

1. The control PCB will fail when the refrigerator power is supplied while the coil resistance is 0 Ω (shorted).
2. When a motion failure of an electronic expansion valve is questioned, always check the resistance value of the electronic expansion valve before replacing the control PCB.

- (2) Oil level switch

Measure the resistance while the connector is disconnected from the control PCB, and check if the contacts are normal in the table below.

Measurement position	Normal condition resistance value			Abnormal condition resistance value
	0 Ω	Infinity	Infinity	
Between connector 1-2	0 Ω	Infinity	Infinity	0 Ω
Between connector 2-3	Infinity	0 Ω	Infinity	0 Ω

[Resistance measurement method]

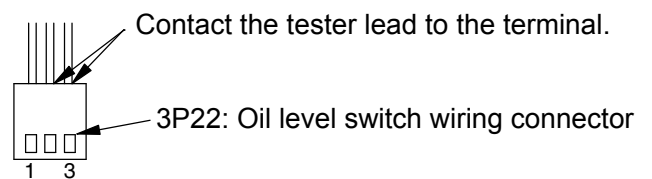

Failure Diagnosis

Failure Diagnosis of Inverter Unit

Caution

When performing an inspection or replacement, make sure to start working after the high voltage danger indication red light on the inverter V1000 and inverter A1000 has been turned off.
(Approx. 5 minutes are required for the capacitor to discharge)

Electrical box internal layout

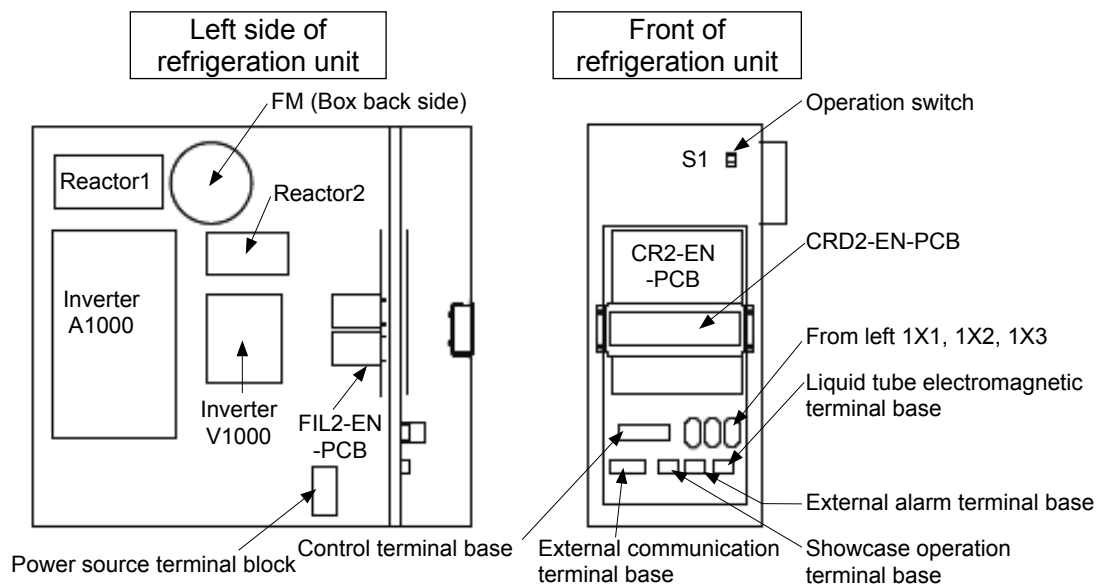

- (1) When the refrigeration unit stopped by activation of the ground fault protector, possible cause is as follows. Check all of the following causes.

Cause	Method of Checking	Method of Action
Compressor failure	Check insulation resistance between each phase of compressor and case. Less than 1 MΩ indicates motor failure.	Replace the compressor
	Check the winding resistance of the compressor. 0.62 Ω to 0.72 Ω (AT 25 °C) indicates no problem.	Replace the compressor
Failure of an electric component other than compressor	Check the insulation resistance between each terminal of the Inverter V1000, Inverter A1000 and ground (G terminal). Less than 1 MΩ indicates insulation failure of the Inverter V1000 or Inverter A1000.	Replace the Inverter V1000 or Inverter A1000.

Caution

Be sure to eliminate the cause of the failure before supplying the power (turning the ground fault protector ON).

Failure Diagnosis

Failure Diagnosis of Inverter Unit

(2) When inverter abnormality (E6XX to E7XX) is generated
Possible cause is as follows. Check all of the following causes.

Cause	Method of Checking	Method of Action
Overload condition	(1) Check if the compressor motor current or fan motor, or both are high. (2) Check if any overload condition occurred even in a short duration of time.	Eliminate the cause of overload.
Abnormality of power voltage	Check if the supplied power voltage to the refrigeration unit is in the range of 380 V \pm 38 V / 400 V \pm 40 V / 415 V \pm 41 V.	Execute maintenance of the power supply facility.
Failure of the Inverter A1000 and Inverter V1000	When the supplied voltage to the refrigeration unit is in the range of 380 V \pm 38 V / 400 V \pm 40 V / 415 V \pm 41 V, check if any abnormality exists in the appearance of the Inverter A1000 and Inverter V1000.	Replace the Inverter A1000 or Inverter V1000, or both.

Caution

When an external cause such as momentary power failure or lightning, or short duration of overload occurs, an error is generated by momentary overcurrent even without any component failure.

Makings for Directive 2014/68/EU (PED)

Rating nameplate figure

Panasonic

Model No. A: Model Name
REFRIGERATION UNIT

POWER SOURCE	3N~50 Hz 380 / 400/ 415 V	REFRIGERANT	R744
INPUT	8. 200/8. 200/8. 200 kW	MAXIMUM WORKING PRESSURE	
CURRENT	13. 3/12. 6/12. 2 A	L. P. /M. P.	80 bar (8. 0 MPa)
		H. P.	120 bar (12. 0 MPa)
CLIMATIC CLASS	0/1/2/3/4/6/8	PRODUCTION DATE	
WATER PROOF GRADE	IPX4	SERIAL NO.	
WEIGHT	320 kg	MAXIMUM REFRIGERANT CHARGE	17 kg

⇨R744⇩ **WARNING:** System contains refrigerant under high pressure.
Do not temper with the system.
It must be serviced by qualified persons only.

Authorized representative in EU
Panasonic Testing Centre Panasonic
Marketing Europe GmbH Winsbergring
15, 22525 Hamburg, Germany

Sales Company in Australia
Husmann Australia Pty. Limited
Sales Company in New Zealand
McAlpine Husmann Limited

Panasonic Corporation
1006 Kadoma, Kadoma City,
Osaka, Japan
Made in Japan

CE 0035



APP. NO.
CS10836N

A: Model Name
OCU-CR1000VF8A
OCU-CR1000VF8ASL

Design Registration No. for WHS regulation (Australian regulation)

Refrigeration Unit is consisted of following pressure equipment covered by WHS regulation.

Plant Name	Hazard Level AS 4343	Design Registration No.	Issued By
Compressor	D	PV 6-231198/19	SafeWork NSW
Intermediate Cooler	D	PV 6-236505/19	SafeWork NSW
Oil Separator	D	PV 6-230383/19	SafeWork NSW

- NOTE -

When an accident or damage is caused by applying an installation method not described in this manual or not using the specified component, our company will not assume responsibility. If a product failure occurs by incorrect installation, the product becomes out of warranty.

Documentation in local language can be downloaded from Internet Panasonic pro club «In the European Market».

Download site: www.panasonicproclub.com

Panasonic Corporation
Website: www.panasonic-europe.com

Sales company in EU
Panasonic Appliances Air Conditioning Europe
(PAPAEU)
Panasonic Marketing Europe GmbH
Hagenauer Str. 43 - 65203 Wiesbaden, Germany

Authorized representative in EU
Panasonic Testing Centre
Panasonic Marketing Europe GmbH
Winsbergring 15, 22525 Hamburg, Germany

Sales company in Australia
Hussmann Australia Pty. Limited
66 Glendenning Rd, Glendenning,
NSW 2761, Australia

Sales company in New Zealand
McAlpine Hussmann Limited
2-6 Niall Burgess Road
Mt Wellington, Auckland 1060,
New Zealand