

CITY MULTI Control System
and Mitsubishi Mr. SLIM Air Conditioners



MA Remote Controller

PAR-40MAA

Instruction Book



Prior to use, thoroughly read the instructions in this manual to use the product correctly.
Retain for future reference.

Make sure that all the included manuals are passed on to any future users.



To ensure safety and proper operation of the remote controller, the remote controller should only be installed by qualified personnel.

Contents

Safety precautions.....	4
Controller components	6
Controller interface	6
Display	8
Menu structure and icons	10
Menu structure	10
Icon explanations	13
Basic operations	14
Power ON/OFF	14
Operation mode, temperature, and fan speed settings	15
Navigating through the menu	18
Main menu list.....	18
Restrictions for the sub remote controller	19
Navigating through the Main menu.....	20
Function settings	21
Vane•Louver•Vent. (Lossnay)	21
High power.....	24
Manual vane angle	25
Timer (On/Off timer).....	28
Timer (Auto-Off timer).....	31
Weekly timer	33
OU silent mode.....	36
Night setback	39
Restriction	42
Energy saving	48
Clock.....	53
Daylight saving time.....	55
Main display	57
Black and white inversion setting.....	58
Contrast•Brightness	60
Language selection.....	61
Initialize remote controller.....	63
Remote controller information.....	65
Troubleshooting	66
Error information	66
No occupancy Auto-OFF	69
Maintenance	70
Filter information	70
Specifications	72
Controller specifications.....	72
Function list (as of October 1, 2018).....	73
List of functions that can/cannot be used in combination ..	74

Safety precautions

- Thoroughly read the following safety precautions before using the unit.
- Observe these precautions carefully to ensure safety.

 WARNING	Indicates a risk of death or serious injury.
 CAUTION	Indicates a risk of serious injury or structural damage.

- After reading this manual, pass it on to the end user to retain for future reference.
- Keep this manual for future reference and refer to it as necessary. This manual should be made available to those who repair or relocate the controller. Make sure that the manual is passed on to any future users.

General precautions

WARNING

Do not install the unit in a place where large amounts of oil, steam, organic solvents, or corrosive gases, such as sulfuric gas, are present or where acidic/alkaline solutions or sprays are used frequently. These substances can compromise the performance of the unit or cause certain components of the unit to corrode, which can result in electric shock, malfunctions, smoke, or fire.

To reduce the risk of injury or electric shock, before spraying a chemical around the controller, stop the operation and cover the controller.

To reduce the risk of shorting, current leakage, electric shock, malfunctions, smoke, or fire, do not wash the controller with water or any other liquid.

To reduce the risk of injury or electric shock, stop the operation and switch off the power supply before cleaning, maintaining, or inspecting the controller.

To reduce the risk of electric shock, malfunctions, smoke or fire, do not operate the switches/buttons or touch other electrical parts with wet hands.

If any abnormality (e.g., burning smell) is noticed, stop the operation, turn off the power switch, and consult your dealer. Continued use of the product may result in electric shock, malfunctions, or fire.

When disinfecting the unit using alcohol, ventilate the room adequately. The fumes of the alcohol around the unit may cause a fire or explosion when the unit is turned on.

Properly install all required covers to keep moisture and dust out of the controller. Dust accumulation and water can cause electric shock, smoke, or fire.

CAUTION

To reduce the risk of fire or explosion, do not place flammable materials or use flammable sprays around the controller.

To reduce the risk of environmental pollution, consult an authorized agency for proper disposal of remote controller.

To reduce the risk of damage to the controller, do not directly spray insecticide or other flammable sprays on the controller.

To reduce the risk of electric shock or malfunctions, do not touch the touch panel, switches, or buttons with a pointy or sharp object.

To reduce the risk of injury and electric shock, avoid contact with sharp edges of certain parts.

To reduce the risk of injury, wear protective gear when working on the controller.

To avoid injury from broken glass, do not apply excessive force on the glass parts.

Precautions for moving or repairing the controller

WARNING

The controller should be repaired or moved only by qualified personnel. Do not disassemble or modify the controller. Improper installation or repair may cause injury, electric shock, or fire.

CAUTION

To reduce the risk of shorting, electric shock, fire, or malfunction, do not touch the circuit board with tools or with your hands, and do not allow dust to accumulate on the circuit board.

Additional precautions

To avoid damage to the controller, use appropriate tools to install, inspect, or repair the controller.

To avoid discoloration, do not use benzene, thinner, or chemical rag to clean the controller. To clean the controller, wipe with a soft cloth soaked in mild detergent that is diluted with an appropriate amount of water, and wipe down with a wet cloth followed by a dry cloth. Do not use the detergent straight.

This controller is designed for exclusive use with the Building Management System by Mitsubishi Electric. The use of this controller for with other systems or for other purposes may cause malfunctions.

To avoid damage to the controller, provide protection against static electricity.

This appliance is not intended for use by persons (including children) with reduced physical, sensory or mental capabilities, or lack of experience and knowledge, unless they have been given supervision or instruction concerning use of the appliance by a person responsible for their safety. Children should be supervised to ensure that they do not play with the appliance.

This appliance is intended to be used by expert or trained users in shops, in light industry and on farms, or for commercial use by lay persons.

If the supply cord is damaged, it must be replaced by the manufacturer, its service agent or similarly qualified persons in order to avoid a hazard.

Controller components

Controller interface

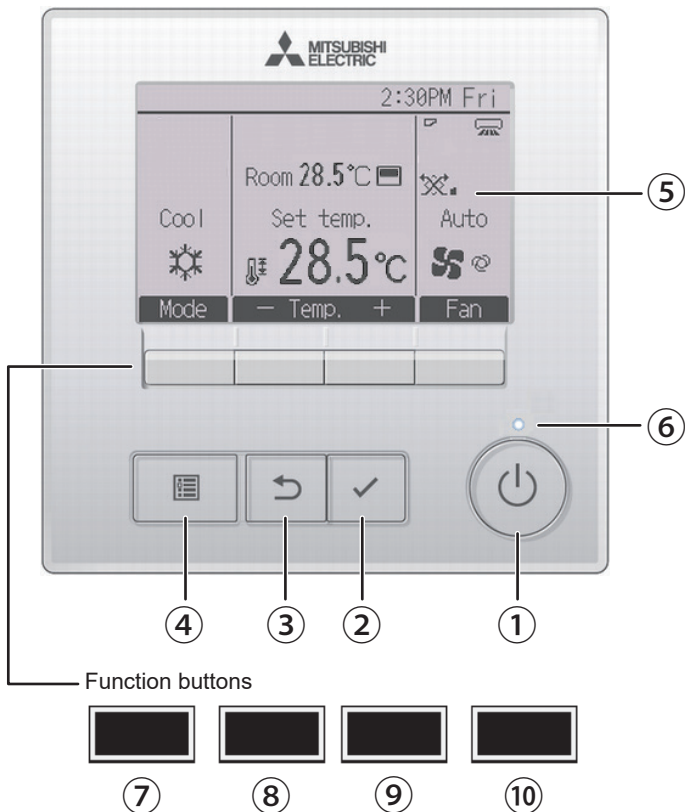

① ON/OFF button

Press to turn ON/OFF the indoor unit.

② SELECT button

Press to save the setting.

③ RETURN button

Press to return to the previous screen.

④ MENU button Page 20

Press to bring up the Main menu.

⑤ Backlit LCD

Operation settings will appear. When the backlight is off, pressing any button turns the backlight on and it will stay lit for a certain period of time depending on the screen.

When the backlight is off, pressing any button turns the backlight on and does not perform its function. (except for the ON/OFF button)

⑥ ON/OFF lamp

This lamp lights up in green while the unit is in operation. It blinks while the remote controller is starting up or when there is an error.

⑦ Function button **F1**

Main display: Press to change the operation mode.

Menu screen: The button function varies with the screen.

The functions of the function buttons change depending on the screen. Refer to the button function guide that appears at the bottom of the LCD for the functions they serve on a given screen.

When the system is centrally controlled, the button function guide that corresponds to the locked button will not appear.

Main display

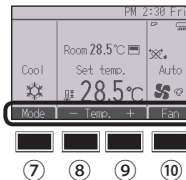

Main menu



Menu screen



Function guide

⑧ Function button **F2**

Main display: Press to decrease temperature.

Main menu: Press to move the cursor left.

Menu screen: The button function varies with the screen.

⑨ Function button **F3**

Main display: Press to increase temperature.

Main menu: Press to move the cursor right.

Menu screen: The button function varies with the screen.

⑩ Function button **F4**

Main display: Press to change the fan speed.

Menu screen: The button function varies with the screen.

Controller components

Display

The main display can be displayed in two different modes: “Full” and “Basic.” The factory setting is “Full.” To switch to the “Basic” mode, change the setting on the Main display setting. (Refer to page 57.)





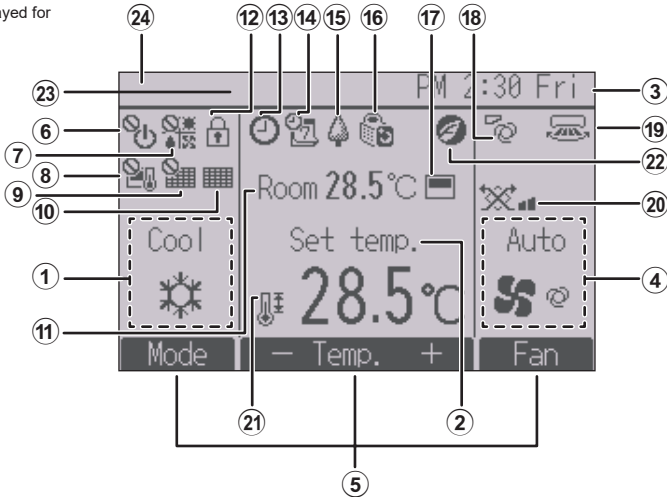

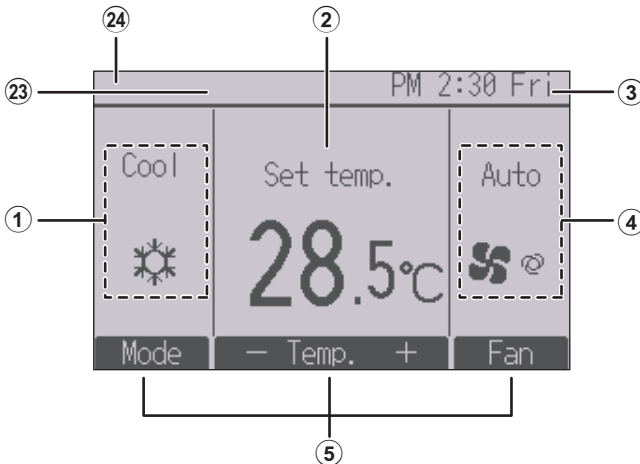

Full mode









* All icons are displayed for explanation.



Basic mode



① Operation mode	Page 15
② Preset temperature	Page 16
③ Clock	See the Installation Manual.
④ Fan speed	Page 17
⑤ Button function guide	Functions of the corresponding buttons appear here.
⑥ 	Appears when the ON/OFF operation is centrally controlled.
⑦ 	Appears when the operation mode is centrally controlled.
⑧ 	Appears when the preset temperature is centrally controlled.
⑨ 	Appears when the filter reset function is centrally controlled.
⑩ 	Page 70 Indicates when filter needs maintenance.
⑪ Room temperature	See the Installation Manual.
⑫ 	Page 45 Appears when the buttons are locked.
⑬ 	Page 28, 31, 39 Appears when the On/Off timer (Page 28), Night setback (Page 39), or Auto-off timer (Page 31) function is enabled.  appears when the timer is disabled by the centralized control system.
⑭ 	Page 33 Appears when the Weekly timer is enabled.

⑮ 	Page 48 Appears while the units are operated in the energy-save mode. (Will not appear on some models of indoor units)
⑯ 	Page 36 Appears while the outdoor units are operated in the silent mode.
⑰ 	Appears when the built-in thermistor on the remote controller is activated to monitor the room temperature (⑪).  appears when the thermistor on the indoor unit is activated to monitor the room temperature.
⑱ 	Page 22 Indicates the vane setting.
⑲ 	Page 22 Indicates the louver setting.
⑳ 	Page 23 Indicates the ventilation setting.
㉑ 	Page 42 Appears when the preset temperature range is restricted.
㉒ 	Appears when an energy-saving operation is performed using a "3D i-See sensor" function.
㉓ Centrally controlled	Appears for a certain period of time when a centrally-controlled item is operated.
㉔ Error display	An error code appears during the error. * When an error code is displayed on the main display, an error is occurring but the indoor unit can keep its operation. Check the error code, and consult your dealer.

Most settings (except ON/OFF, mode, fan speed, temperature) can be made from the Main menu. (Refer to Page 20.)

Menu structure and icons

Menu structure

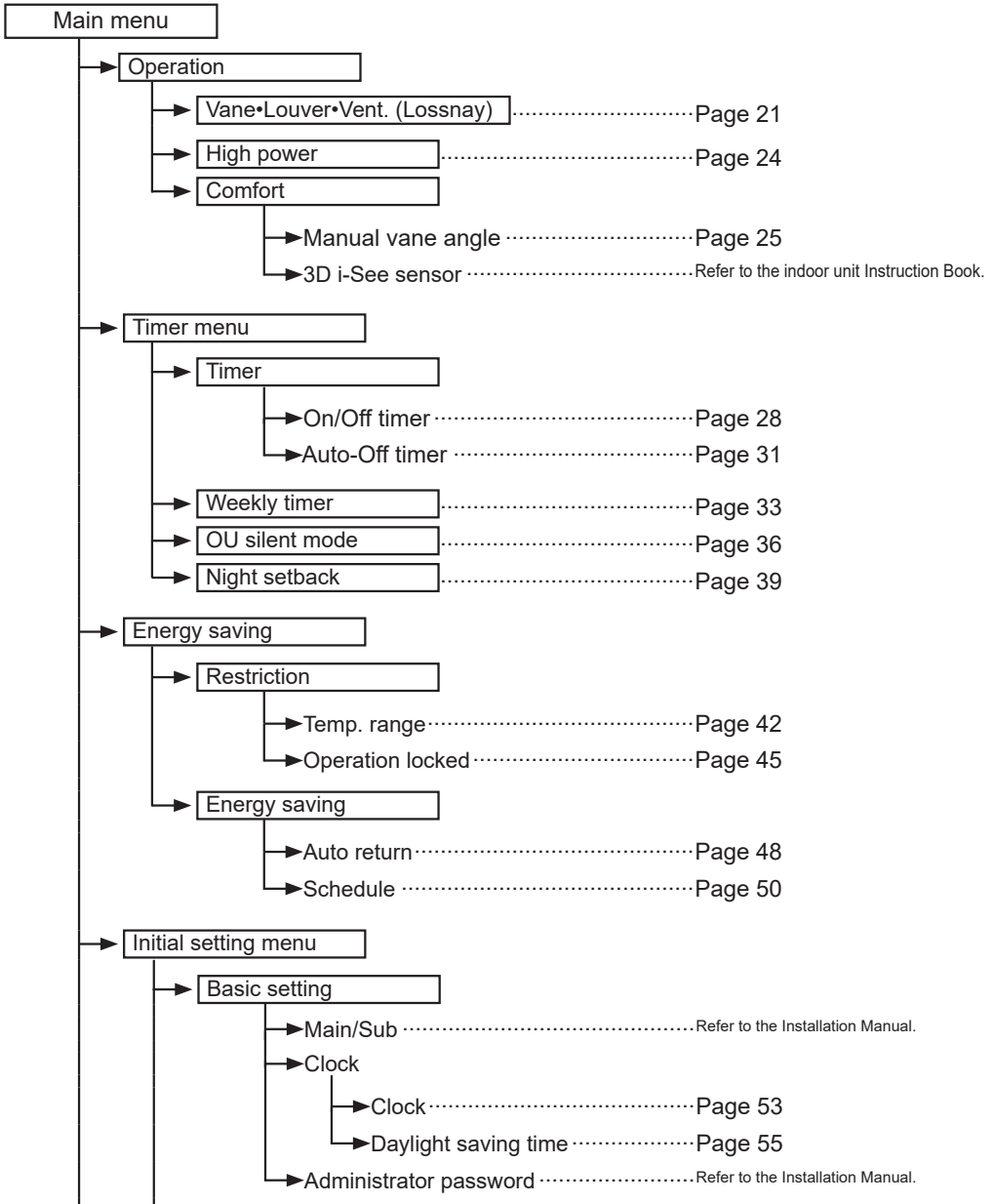

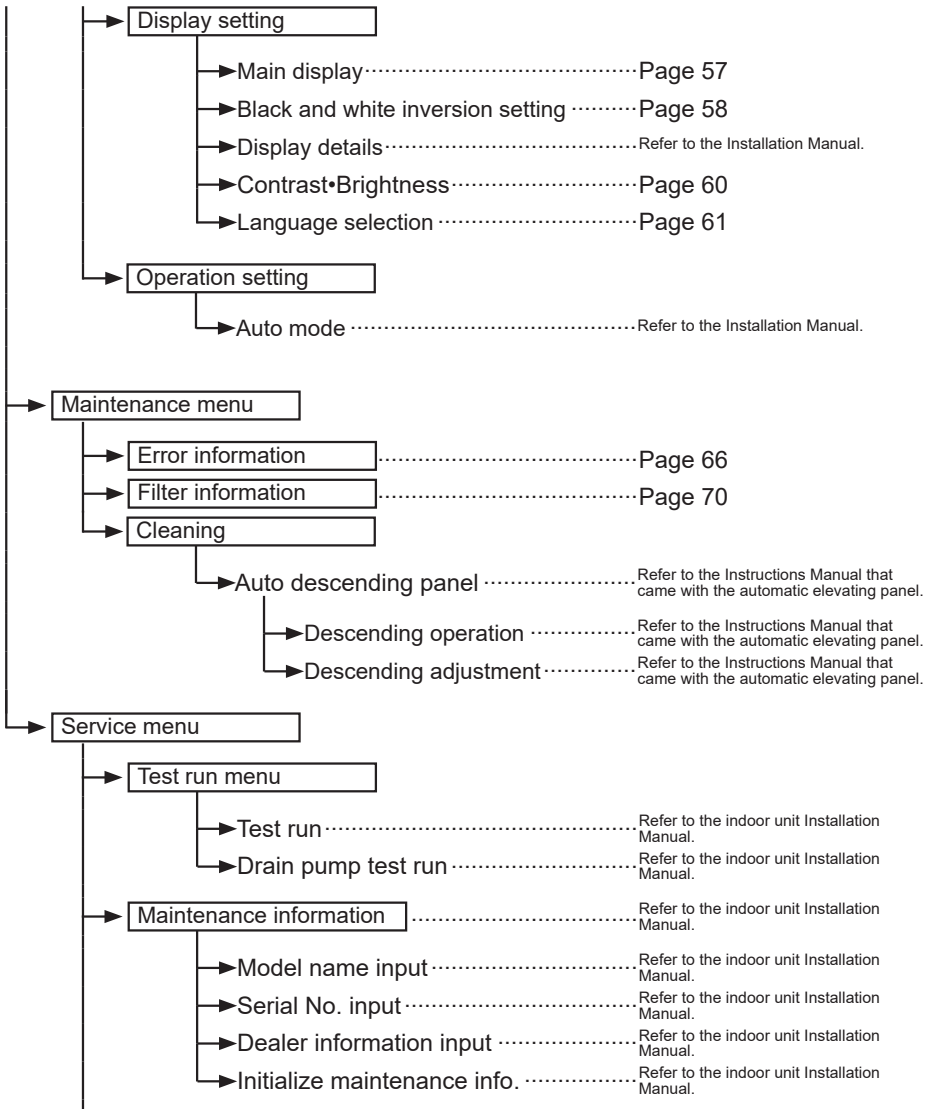

Menu structure and icons

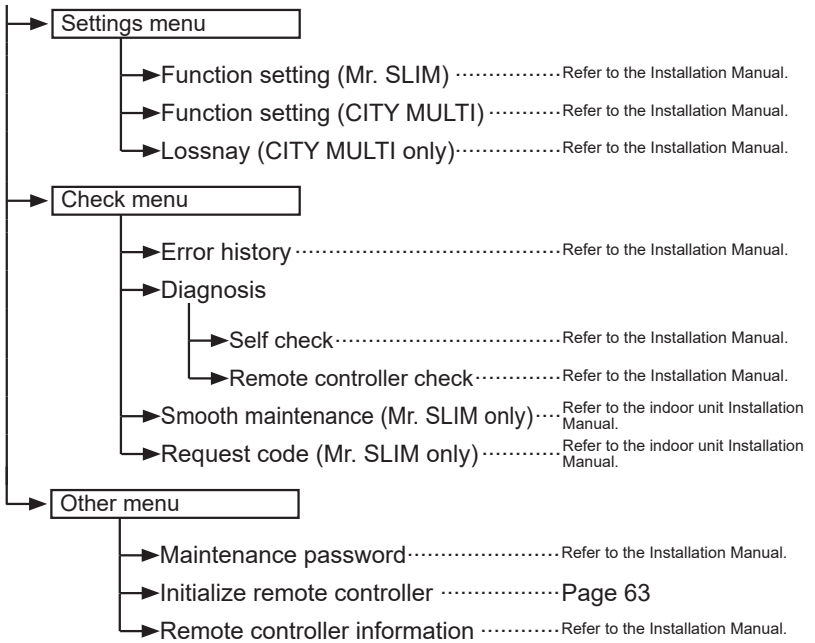

Not all functions are available on all models of indoor units.

Icon explanations

Controller operation

Timer



The table below summarizes the square icons used in this manual.



The administrator or maintenance user password must be entered on the password input screen to change settings. There is no settings that can skip this process.



F1 F2 F3 F4

- F1** : Press to move the cursor left.
- F2** : Press to move the cursor right.
- F3** : Press to decrease the value by 1.
- F4** : Press to increase the value by 1.

* Changes cannot be made unless the correct password is entered.



Indicates settings that can be made only from the main remote controller.



Indicates settings that can be changed only while the units are in operation.



Indicates settings that can be changed only while the units are not in operation.



Indicates settings that can be changed only while the units are operated in the Cool, Heat, or Auto mode.



Indicates functions that are not available when the buttons are locked or the system is centrally controlled.

Basic operations

Power ON/OFF



Button operation

ON

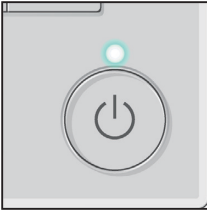

Press the **ON/OFF** button.

The ON/OFF lamp will light up in green, and the operation will start.

When “LED lighting” is set to “No,” the ON/OFF lamp will not light up.

OFF



Press the **ON/OFF** button again.

The ON/OFF lamp will come off, and the operation will stop.

Operation mode, temperature, and fan speed settings



Button operation

Operation mode

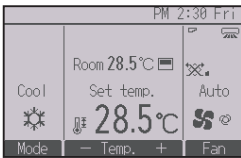

Each pressing of the **F1** button cycles through the following operation modes.

Select the desired operation mode.



Cool



Dry



Fan



Auto



Heat

- Operation modes that are not available to the connected indoor unit models will not appear on the display.

What the blinking mode icon means

The mode icon will blink when other indoor units in the same refrigerant system (connected to the same outdoor unit) are already operated in a different mode. In this case, the rest of the unit in the same group can only be operated in the same mode.

<Auto (dual set point) mode>

When the operation mode is set to the Auto (dual set point) mode, two preset temperatures (one each for cooling and heating) can be set. Depending on the room temperature, indoor unit will automatically operate in either the Cool or Heat mode and keep the room temperature within the preset range.

The graph below shows the operation pattern of indoor unit operated in the Auto (dual set point) mode.

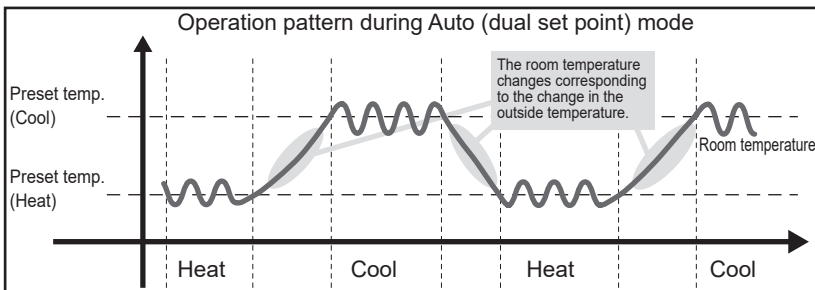

Basic operations

Preset temperature

<Cool, Dry, Heat, and Auto (single set point)>

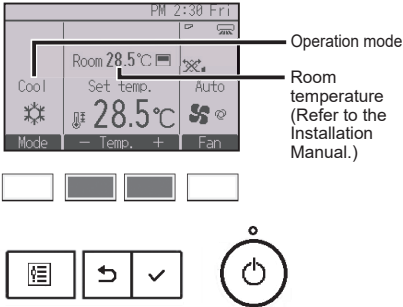

Press the **[F2]** button to decrease the preset temperature, and press the **[F3]** button to increase.

- Refer to the table on page 17 for the settable temperature range for different operation modes.
- Preset temperature range cannot be set for Fan/Ventilation operation.
- Preset temperature will be displayed either in Centigrade in 0.5- or 1-degree increments, or in Fahrenheit, depending on the indoor unit model and the display mode setting on the remote controller.

<Auto (dual set point) mode>

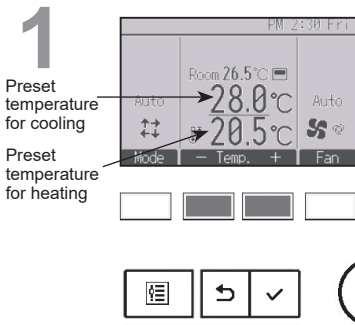

The current preset temperatures will appear.

Press the **[F2]** or **[F3]** button to display the Settings screen.

2

Preset temperature for cooling

Preset temperature for heating

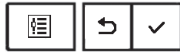
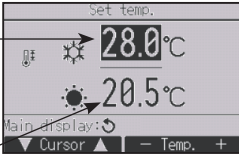

Press the **[F1]** or **[F2]** button to move the cursor to the desired temperature setting (cooling or heating).

Press the **[F3]** button to decrease the selected temperature, and press the **[F4]** button to increase.

- Refer to the table below for the settable temperature range for different operation modes.
- The preset temperature settings for cooling and heating in the Auto (dual set point) mode are also used by the Cool/Dry and Heat modes.
- The preset temperatures for cooling and heating in the Auto (dual set point) mode must meet the conditions below:

- Preset cooling temperature is higher than preset heating temperature.
- The minimum temperature difference requirement between cooling and heating preset temperatures (varies with the models of indoor units connected) is met.
- If preset temperatures are set in a way that does not meet the minimum temperature difference requirement, both preset temperatures will automatically be changed within the allowable setting ranges.

Settable preset temperature range

Operation mode	Preset temperature range
Cool/Dry	19 ~ 30 °C (67 ~ 87 °F)
Heat	17 ~ 28 °C (63 ~ 83 °F)
Auto (Single set point)	19 ~ 28 °C (67 ~ 83 °F)
Auto (Dual set points)	[Cool] Preset temperature range for the Cool mode [Heat] Preset temperature range for the Heat mode
Fan/Ventilation	Not settable

The settable temperature range varies with the model of indoor units.

Fan speed

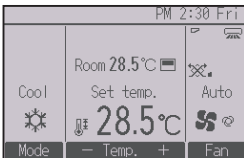

Each pressing of the **[F4]** button cycles through the following fan speeds.



- The available fan speeds depend on the models of connected indoor units.

Navigating through the menu

Main menu list

Main menu	Setting items		Setting details	Page
Operation	Vane•Louver•Vent. (Lossnay)		<p>Use to set the vane angle.</p> <ul style="list-style-type: none"> Select a desired vane setting from five different settings. <p>Use to turn ON/OFF the louver.</p> <ul style="list-style-type: none"> Select a desired setting from “ON” and “OFF.” <p>Use to set the amount of ventilation.</p> <ul style="list-style-type: none"> Select a desired setting from “Off,” “Low,” and “High.” 	21
	High power		<p>Use to reach the comfortable room temperature quickly.</p> <ul style="list-style-type: none"> Units can be operated in the High-power mode for up to 30 minutes. 	24
	Comfort	Manual vane angle	<p>Use to fix each vane angle.</p>	25
Timer	Timer	On/Off timer	<p>Use to set the operation On/Off times.</p> <ul style="list-style-type: none"> Time can be set in 5-minute increments. * Clock setting is required. 	28
		Auto-Off timer	<p>Use to set the Auto-Off time.</p> <ul style="list-style-type: none"> Time can be set to a value from 30 to 240 in 10-minute increments. 	31
	Weekly timer		<p>Use to set the weekly operation On/Off times.</p> <ul style="list-style-type: none"> Up to eight operation patterns can be set for each day. Two types of weekly schedules can be set. * Clock setting is required. * Not valid when the On/Off timer is enabled. * 1°C increments 	33
	OU silent mode		<p>Use to set the time periods in which priority is given to quiet operation of outdoor units over temperature control. Set the Start/Stop times for each day of the week.</p> <ul style="list-style-type: none"> Select the desired silent level from “Normal,” “Middle,” and “Quiet.” * Clock setting is required. 	36
	Night setback		<p>Use to make Night setback settings.</p> <ul style="list-style-type: none"> Select “Yes” to enable the setting, and “No” to disable the setting. The temperature range and the start/stop times can be set. * Clock setting is required. * 1°C increments 	39
Energy saving	Restriction	Temp. range	<p>Use to restrict the preset temperature range.</p> <ul style="list-style-type: none"> Different temperature ranges can be set for different operation modes. * 1°C increments 	42
		Operation locked	<p>Use to lock selected functions.</p> <ul style="list-style-type: none"> The locked functions cannot be operated. 	45
	Energy saving	Auto return	<p>Use to get the units to operate at the preset temperature after performing energy-save operation for a specified time period.</p> <ul style="list-style-type: none"> Time can be set to a value from 30 and 120 in 10-minute increments. * This function will not be valid when the preset temperature ranges are restricted. * 1°C increments 	48

Main menu	Setting items	Setting details	Page	
Energy saving	Energy saving	Schedule Set the start/stop times to operate the units in the energy-save mode for each day of the week, and set the energy-saving rate. • Up to four energy-save operation patterns can be set for each day. • Time can be set in 5-minute increments. • Energy-saving rate can be set to a value from 0% and 50 to 90% in 10% increments. * Clock setting is required.	50	
Initial setting	Basic setting	Clock	Use to set the current time.	53
		Daylight saving time	Sets the daylight saving time.	55
	Display setting	Main display	Use to switch between "Full" and "Basic" modes for the Status display and the Main display. • The default setting is "Full."	57
		Black and white inversion setting	Use to invert the colors of the display, turning white background to black and black characters to white.	58
		Contrast-Brightness	Use to adjust screen contrast and brightness.	60
		Language selection	Use to select the desired language.	61
Service	Initialize remote controller	Use to initialize the remote controller to the factory shipment status.	63	
	Remote controller information	Use to display the remote controller model name, software version, and serial number.	65	
Maintenance	Error information	Use to check error information when an error occurs. • Error code, error source, refrigerant address, unit model, manufacturing number, contact information (dealer's phone number) can be displayed. * The unit model, manufacturing number, and contact information need to be registered in advance to be displayed.	66	
	Filter information	Use to check the filter status. • The filter sign can be reset.	70	

Restrictions for the sub remote controller



The following settings cannot be made from the sub remote controller. Make these settings from the main remote controller. "Main" is displayed in the title of the Main menu on the main remote controller.

- Timer
(On/Off timer, Auto-Off timer, Weekly timer, Night setback, OU silent mode)
- Energy saving
(Auto return, Schedule)
- Maintenance
(Manual vane angle)

Navigating through the menu

Navigating through the Main menu

Button operation

Accessing the Main menu

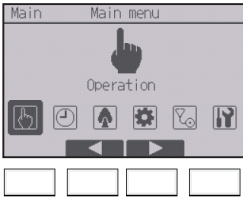

Press the **[Menu]** button on the Main display.

The Main menu will appear.

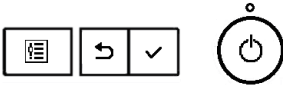

Item selection

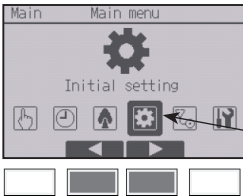

Press **[F2]** to move the cursor left.

Press **[F3]** to move the cursor right.

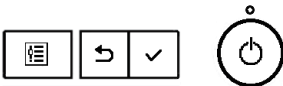

Function settings

Vane•Louver•Vent. (Lossnay)

ON

Button operation

Accessing the menu

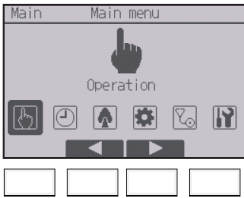

Select “Operation” from the Main menu (refer to page 20), and press the **[SELECT]** button.



Select “Vane•Louver•Vent. (Lossnay)” from the Operation menu, and press the **[SELECT]** button.



Function settings

Vane setting

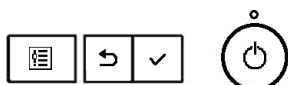
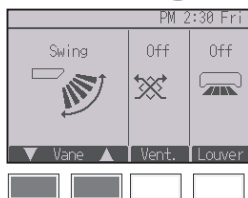

(Sample screen on CITY MULTI)

Each pressing of the **[F1]** or **[F2]** button cycles through the following vane settings. Select the desired setting.

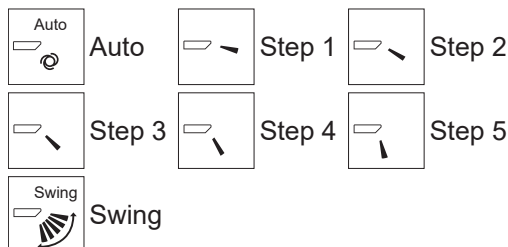

Select "Swing" to move the vanes up and down automatically.

When set to "Step 1" through "Step 5", the vane will be fixed at the selected angle.

- **[1h]** under the vane setting icon

This icon will appear when the vane is set to "Step 5" and the fan operates at low speed during cooling or dry operation (depends on the model).

The icon will go off in an hour, and the vane setting will automatically change.

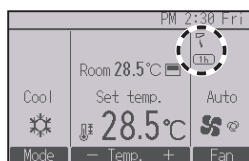

Louver setting

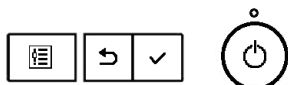
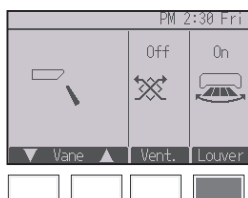

(Sample screen on CITY MULTI)

Press the **[F4]** button to turn the louver swing ON and OFF.



Ventilation setting

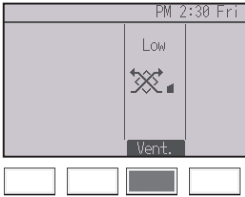

(Sample screen on Mr. SLIM)

Each pressing of the **[F3]** button cycles through the following ventilation settings.

* Settable only when Lossnay unit is connected.



- The fan on some models of indoor units may be interlocked with certain models of ventilation units.

Returning to the Operation menu

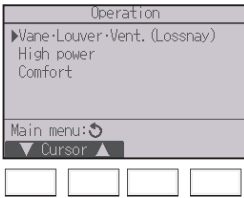

Press the **[RETURN]** button to go back to the Operation menu.

Function settings

High power



Function description

High-power operation function allows the units to operate at higher-than-normal capacity so that the room air can be conditioned to an optimum temperature quickly. This operation will last for up to 30 minutes, and the unit will return to the normal operation mode at the end of the 30 minutes or when the room temperature reaches the preset temperature, whichever is earlier. The units will return to the normal operation when the operation mode or fan speed is changed.

Button operation

1



Select “High power” from the Operation menu during Cooling, Heating, or Auto operation, and press the **SELECT** button.

“High power” function is available only on the models that support the function.



2



Move the cursor to “Yes” with the **F3** or **F4** button, and press the **SELECT** button.

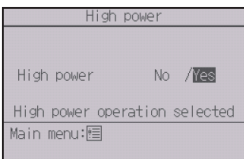

A confirmation screen will appear.

Navigating through the screens

- To go back to the Main menu **MENU** button
- To return to the previous screen **RETURN** button

Manual vane angle

Main OFF

Button operation

1



Select "Comfort" from the Operation menu, and press the **SELECT** button.



2

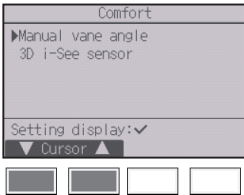

Select "Manual vane angle" with the **F1** or **F2** button, and press the **SELECT** button.



Function settings

3



Move the cursor to "Ref. address" or "Unit No." with the **[F1]** button to select.

Select the refrigerant address and the unit number for the units to whose vanes are to be fixed, with the **[F2]** or **[F3]** button, and press the **[SELECT]** button.

- Ref. address: Refrigerant address
- Unit No.: 1, 2, 3, 4

Press the **[F4]** button to confirm the unit.

The screen at left shows a sample display on Mr. SLIM. On CITY MULTI units, "M-NET address" is displayed instead of "Ref. address", and the "Unit No." will not be displayed.

4

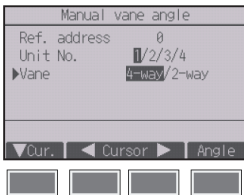

Select "Vane" with the **[F1]** button.

Select "4-way" or "2-way" with the **[F2]** or **[F3]** button, and press the **[F4]** button.

5

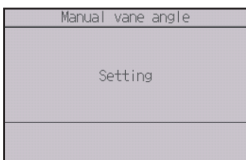
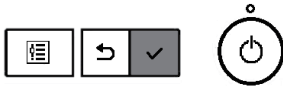
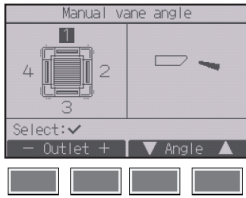

The current vane setting will appear.

Select the desired outlets from “1,” “2,” “3,” “4,” or “1, 2, 3, 4 (all outlets)” with the **[F1]** or **[F2]** button.

Press the **[F3]** or **[F4]** button to go through the following options and select the desired setting.

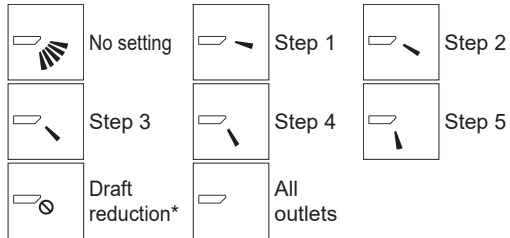

Press the **[SELECT]** button to save the settings.

A screen will appear that indicates the setting information is being transmitted.

The setting changes will be made to the selected outlet.

The screen will automatically return to the previous screen when the transmission is completed.

Make the settings for other outlets, following the same procedures.

If all outlets are selected,  will be displayed the next time the unit goes into operation.

Navigating through the screens

- To return to the previous screen **[RETURN]** button

*Draft reduction

The [Draft reduction] mode keeps the vane angle more horizontal than the angle of Step 1 so that the airflow will not be directed toward the people.

This function can be set only for one outlet.

This function cannot be set for models with two or three outlets.

In the Draft reduction mode, the airflow may cause the ceiling discoloration.

Function settings

Timer (On/Off timer)

Main

P

Button operation

1

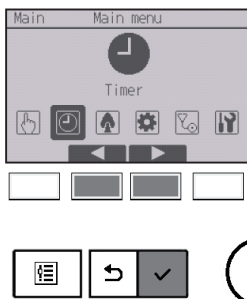

Select "Timer" from the Main menu (refer to page 20), and press the **SELECT** button.

The On/Off timer will not work in the following cases:

when On/Off timer is disabled, during an error, during check (in the service menu), during test run, during remote controller diagnosis, when the clock is not set, during function setting, when the system is centrally controlled (when On/Off operation or timer operation from local remote controller is prohibited).

2

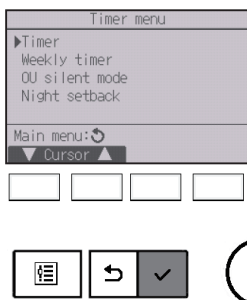

Move the cursor to "Timer," and press the **SELECT** button.

3

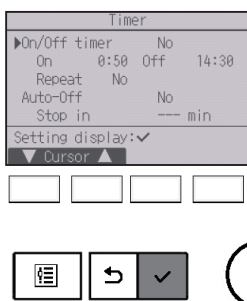

The current settings will appear.

Move the cursor to "On/Off timer," and press the **SELECT** button.

4

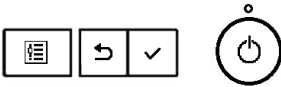

The screen to set the timer will appear.

Select the desired item with the **F1** or **F2** button out of “On/Off timer,” “On,” “Off,” or “Repeat.”

5

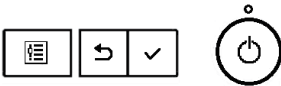

Change the setting with the **F3** or **F4** button.

- On/Off timer: No (disable)/Yes (enable)
- On: Operation start time
(settable in 5-minute increments)
* Press and hold the button to rapidly advance the numbers.
- Off: Operation stop time
(settable in 5-minute increments)
* Press and hold the button to rapidly advance the numbers.
- Repeat: No (once)/Yes (repeat)

Function settings

6



Press the **SELECT** button to save the settings.





A confirmation screen will appear.

Navigating through the screens

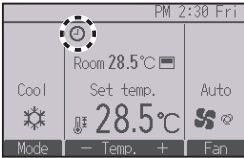
- To go back to the Main menu **MENU** button
- To return to the previous screen **RETURN** button



 will appear on the Main display in the Full mode when the On/Off timer is enabled.

 appears when the timer is disabled by the centralized control system.

Button operation

1



Bring up the Timer setting screen.
(Refer to page 28.)

Select “Auto-Off”, and press the **[SELECT]** button.

The Auto-Off timer will not work in the following cases:

when Auto-Off timer is disabled, during an error, during check (in the service menu), during test run, during remote controller diagnosis, during function setting, when the system is centrally controlled (when On/Off operation or timer operation from local controller is prohibited).

2

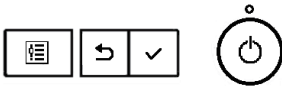

The current settings will appear.

Move the cursor to “Auto-Off” or “Stop in --- min” with the **[F1]** or **[F2]** button.

3

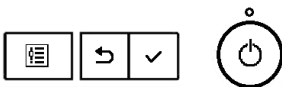
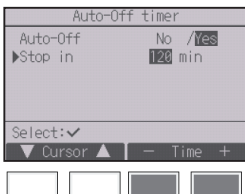

Change the setting with the **[F3]** or **[F4]** button.

- Auto-Off: No (disable)/Yes (enable)
- Stop in --- min: Timer setting (The settable range is 30 to 240 minutes in 10-minute increments.)

Function settings

4

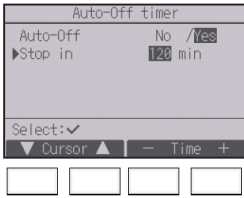

Press the **SELECT** button to save the settings.

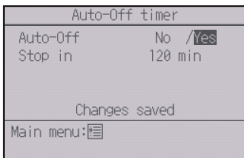



A confirmation screen will appear.

Navigating through the screens

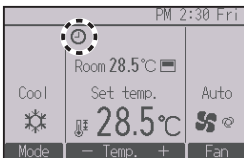
- To go back to the Main menu **MENU** button
- To return to the previous screen **RETURN** button



 will appear on the Main display in the Full mode when the Auto-Off timer is enabled.

 appears when the timer is disabled by the centralized control system.

Button operation

1



Select "Weekly timer" from the Timer menu, and press the **[SELECT]** button.

The Weekly timer will not work in the following cases:
 when the On/Off timer is enabled, when the weekly timer is disabled, during an error, during check (in the service menu), during test run, during remote controller diagnosis, when the clock is not set, during function setting, when the system is centrally controlled (On/Off operation, temperature setting, or timer operation from local remote controller is prohibited).

2

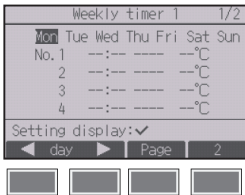

The current settings will appear.

Press the **[F1]** or **[F2]** button to see the settings for each day of the week.

Press the **[F3]** button to see patterns 5 through 8.

Press the **[F4]** button to display the status of Setting 2.

Press the **[SELECT]** button to go to the setting screen.

Function settings

3



The weekly timer settings screen will appear.

In the “Action” setting, select “1” to enable the timer setting 1, or select “2” to enable the timer setting 2 with the **[F3]** or **[F4]** button. Then, press the **[SELECT]** button.

To check the setting contents of the timer setting 1 or 2, move the cursor to “Setting” with the **[F1]** or **[F2]** button, and select “1” or “2” with the **[F3]** or **[F4]** button.

4

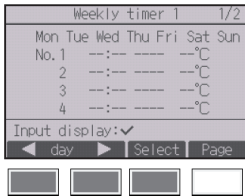

The weekly timer setting screen will appear and the current settings will be displayed.

Up to eight operation patterns can be set for each day.

Move the cursor to the desired day of the week with the **[F1]** or **[F2]** button, and press the **[F3]** button to select it. (Multiple days can be selected.)

Press the **[SELECT]** button.

5

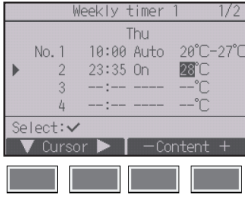

Operation pattern setting screen will appear.

Press the **[F1]** button to move the cursor to the desired pattern number.

Move the cursor to the time, On/Off, or temperature with the **[F2]** button.

Change the settings with the **[F3]** or **[F4]** button.

- Time: settable in 5-minute increments
 - * Press and hold the button to rapidly advance the numbers.
- On/Off/Auto: Selectable settings depend on the model of connected indoor unit. (When an Auto pattern is executed, the system will operate in the Auto (dual set point) mode.)
- Temperature: The settable temperature range depends on the connected indoor units. (1°C increments)
 - When the Auto (dual set point) mode is selected, two preset temperatures can be set. If an operation pattern with a single preset temperature setting is executed during the Auto (dual set point) mode, its setting will be used as the cooling temperature setting in the Cool mode.

Press the **[SELECT]** button to save the settings.

A confirmation screen will appear.

Navigating through the screens

- To go back to the setting change/day of the week selection screen **[SELECT]** button
- To go back to the Main menu **[MENU]** button
- To return to the previous screen **[RETURN]** button

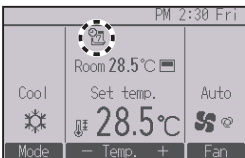

 will appear on the Main display in the Full mode when the weekly timer setting for the current day exists.

The icon will not appear while the On/Off timer is enabled or the system is under centralized control (Timer operation from local remote controller is prohibited).

Function settings

OU silent mode

Main

P

Function description

This function allows the user to set the time periods in which priority is given to quiet operation of outdoor units over temperature control. Set the start and stop times each day of the week for the quiet operation. Select the desired silent level from "Middle" and "Quiet".

Button operation

1

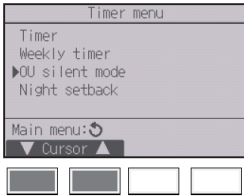

Select "OU silent mode" from the Timer menu, and press the **SELECT** button.

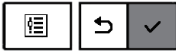

"OU silent mode" function is available only on the models that support the function.

2

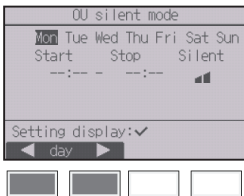

The current settings will appear.

Press the **F1** or **F2** button to see the settings for each day of the week.

Press the **SELECT** button to go to the setting screen.

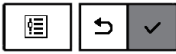

3

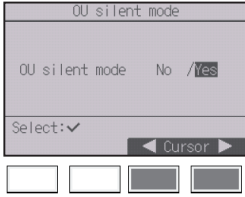

The screen to enable (Yes) and disable (No) the silent mode will appear.

To enable this setting, move the cursor to “Yes” with the **F3** or **F4** button, and press the **SELECT** button .

4

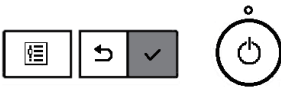
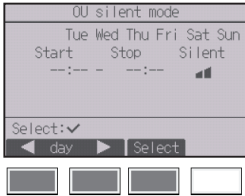

The OU silent mode setting screen will appear.

To make or change the setting, move the cursor to the desired day of the week with the **F1** or **F2** button, and press the **F3** button to select it. (Multiple days can be selected.)

Press the **SELECT** button.

Function settings

5

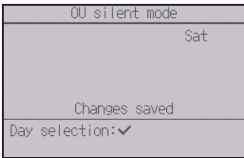
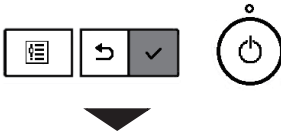

The setting screen will appear.

Move the cursor to the desired item with the **[F1]** or **[F2]** button out of Start time, Stop time, or Silent level.

Change the settings with the **[F3]** or **[F4]** button.

- Start/Stop time: settable in 5-minute increments
 - * Press and hold the button to rapidly advance the numbers.
- Silent level: Normal, Middle, Quiet



Press the **[SELECT]** button to save the settings. A confirmation screen will appear.

Navigating through the screens

- To go back to the setting change/day of the week selection screen **[SELECT]** button
- To go back to the Main menu **[MENU]** button
- To return to the previous screen **[RETURN]** button

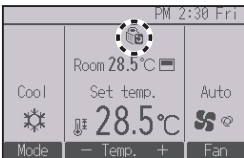

will appear on the Main display in the Full mode during the OU silent mode.

Function description

This control starts heating operation when the control object group is stopped and the room temperature drops below the preset lower limit temperature. Also, this control starts cooling operation when the control object group is stopped and the room temperature rises above the preset upper limit temperature.

The Night setback function is not available if the operation and the temperature setting are performed from the remote controller.

If the room temperature is measured by the air-conditioner's suction temperature sensor, the accurate temperature may not be obtained when the air-conditioner is inactive or when the air is not clean. In this case, switch the sensor to a remote sensor (PAC-SE40TSA/PAC-SE41TS-E) or a remote control sensor.

Button operation

- 1 Select "Night setback" from the Timer menu, and press the **SELECT** button.



Select "Night setback" from the Timer menu, and press the **SELECT** button.

- 2 The current settings will appear.
Press the **SELECT** button to go to the setting screen.

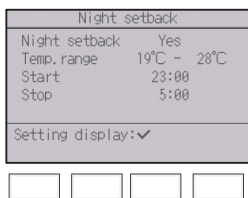

Function settings

3

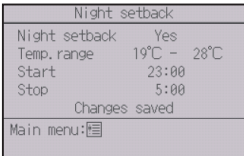
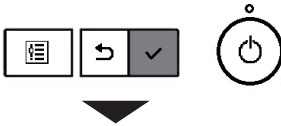

Move the cursor to the desired item with the **[F1]** or **[F2]** button out of Night setback No (disable)/Yes (enable), Temp. range, Start time, or Stop time.

Change the settings with the **[F3]** or **[F4]** button.

- Temp. range: The lower limit temperature (for heating operation) and the upper limit temperature (for cooling operation) can be set. The temperature difference between the lower and upper limits must be 4°C (8°F) or more. The settable temperature range varies depending on the connected indoor units.
 - * 1°C increments
- Start/Stop time: settable in 5-minute increments
 - * Press and hold the button to rapidly advance the numbers.

Press the **[SELECT]** button to save the settings. A confirmation screen will appear.

Navigating through the screens

- To go back to the Main menu **[MENU]** button
- To return to the previous screen **[RETURN]** button

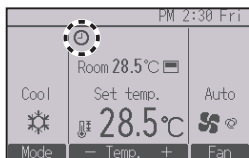

 will appear on the Main display in the Full mode when the Night setback function is enabled.

 appears when the timer is disabled by the centralized control system.

The Night setback will not work in the following cases:

when the unit is in operation, when the Night setback function is disabled, during an error, during check (in the service menu), during test run, during remote controller diagnosis, when the clock is not set, during function setting, when the system is centrally controlled (On/Off operation, temperature setting, or timer operation from local remote controller is prohibited).

Function settings

Restriction

P

Setting the temperature range restriction

Button operation

1

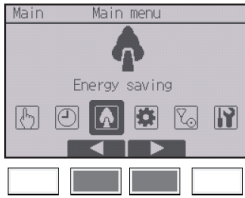

Select “Energy saving” from the Main menu (refer to page 20), and press the **SELECT** button.



2

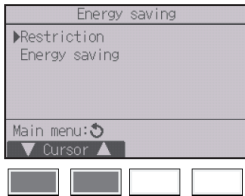

Move the cursor to “Restriction” with the **F1** or **F2** button, and press the **SELECT** button.



3

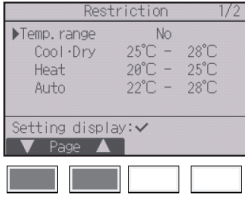

The current settings will appear.

Move the cursor to “Temp. range” with the **F1** or **F2** button, and press the **SELECT** button.



4

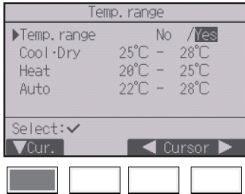

The screen to set the temperature range will appear.

Move the cursor to the desired item with the **F1** button out of “Temp. range,” “Cool-Dry,” “Heat,” or “Auto.”

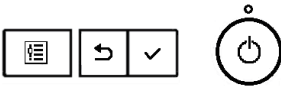

Function settings

5

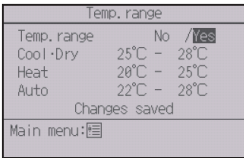
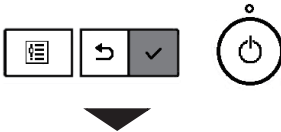
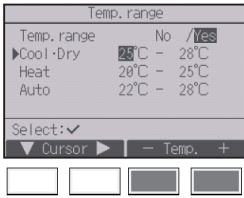

Change the settings with the **[F3]** or **[F4]** button.

- Temp. range: No (unrestricted) or Yes (restricted)
- Cool•Dry: Upper and lower limit temperature (1°C increments)
- Heat: Upper and lower limit temperature (1°C increments)
- Auto: Upper and lower limit temperature (1°C increments)

Temperature setting ranges

Mode		Lower limit	Upper limit
Cool•Dry	*1	19 ~ 30°C	30 ~ 19°C
	*3	(67 ~ 87°F)	(87 ~ 67°F)
Heat	*2	17 ~ 28°C	28 ~ 17°C
	*3	(63 ~ 83°F)	(83 ~ 63°F)
Auto	*4	19 ~ 28°C	28 ~ 19°C
		(67 ~ 83°F)	(83 ~ 67°F)

- * The settable range varies depending on the connected unit.
- *1 Temperature ranges for the Cool, Dry, and Auto (dual set point) modes can be set.
- *2 Temperature ranges for the Heat and Auto (dual set point) modes can be set.
- *3 Temperature ranges for the Heat, Cool, and Dry modes must meet the conditions below:
 - Upper limit for cooling - upper limit for heating \geq Minimum temperature difference (varies with indoor unit model)
 - Lower limit for cooling - lower limit for heating \geq Minimum temperature difference (varies with indoor unit model)
- *4 Temperature range for the Auto (single set point) mode can be set.

Press the **[SELECT]** button to save the settings.

A confirmation screen will appear.

Navigating through the screens

- To go back to the Main menu **[MENU]** button
- To return to the previous screen **[RETURN]** button

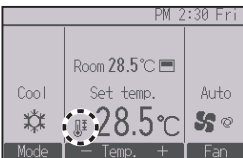

 will appear on the Main display in the Full mode when the temperature range is restricted.

Operation lock function

Button operation

To enable the operation lock function, set the item "Operation locked" to "Yes".

1

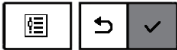

Bring up the Restriction setting screen. (Refer to page 42.)

Move the cursor to "Operation locked" and press the **SELECT** button.

Function settings

2

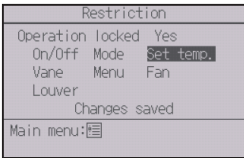
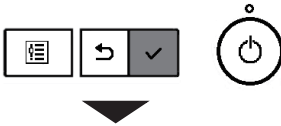

The screen to make the settings for the operation lock function will appear.

Move the cursor to the desired item with the **[F1]** or **[F2]** button out of “Operation locked,” “Location,” “On/Off,” “Mode,” “Set temp.,” “Menu,” “Fan,” “Louver,” or “Vane.”

Change the settings with the **[F3]** or **[F4]** button.

- Operation locked: No (disable)/Yes (enable)
- Location: “Individual” or “Hotel”
- On/Off: On/Off operation
- Mode: Operation mode setting
- Set temp.: Preset temp. setting
- Vane: Vane setting
- Menu: Menu setting
- Fan: Fan speed setting
- Louver: Louver setting

“-” / “Locked”

When “Hotel” is selected for the “Location” setting, the following operations will be locked automatically: Mode, Vane, Menu, and Louver.

Press the **[SELECT]** button to save the settings.

A confirmation screen will appear.

Navigating through the screens

- To go back to the Main menu **[MENU]** button
- To return to the previous screen **[RETURN]** button

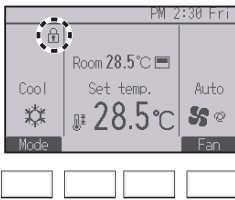

 will appear on the Main display in the Full mode when the operation lock function setting is enabled.

Operation guide that corresponds to the locked function will be suppressed.

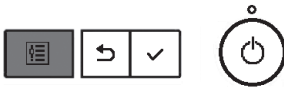

To display the main menu while the menu setting is being locked, press and hold the **Menu** button for ten or more seconds. Enter the administrator's password on the password input screen.

Function settings

Energy saving

Main

P

Automatic return to the preset temperature

After the Auto return function is enabled, when the operation mode change or ON/OFF operation is performed from this remote controller, the set temperature automatically returns to the required temperature regardless of the set time.

Button operation

1



Select “Energy saving” from the Energy saving menu, and press the **[SELECT]** button.



2

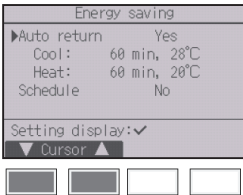

The current settings will appear.

Move the cursor to “Auto return” with the **[F1]** or **[F2]** button, and press the **[SELECT]** button.

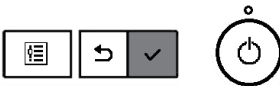

3



The screen to make the settings for the automatic return to the preset temperature will appear.

Move the cursor to the desired item with the **[F1]** or **[F2]** button out of “Auto return,” “Cool,” or “Heat.”

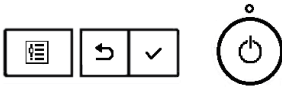

4



Change the settings with the **[F3]** or **[F4]** button.

- Auto return: No (disable)/Yes (enable)
- Cool: Timer setting range is 30 to 120 minutes in 10-minute increments.
Temperature setting range is 19 to 30°C (67 to 87°F) (1°C increments).
- Heat: Timer setting range is 30 to 120 minutes in 10-minute increments.
Temperature setting range is 17 to 28°C (63 to 83°F) (1°C increments).

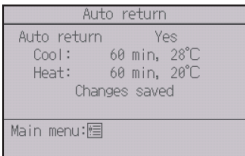
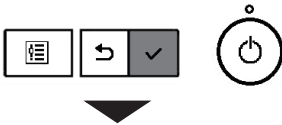

Press the **[SELECT]** button to save the settings. “Cool” includes “Dry” and “Auto Cool” modes, and “Heat” includes “Auto Heat” mode.

The screen to set the selected item will appear.

Navigating through the screens

- To go back to the Main menu **[MENU]** button
- To return to the previous screen **[RETURN]** button

Timer or preset temperature settings will not be effective when the temperature range is restricted and when the system is centrally controlled (when the temperature range setting from local controller is prohibited). When the system is centrally controlled (when timer operation from local remote controller is prohibited), only the timer setting will be ineffective.

Function settings

Energy saving

Main

P

Setting the energy-saving operation schedule

Button operation

1

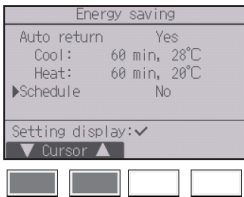

Bring up the “Energy saving” screen. (Refer to page 48.)

Move the cursor to “Schedule,” and press the **SELECT** button.



2

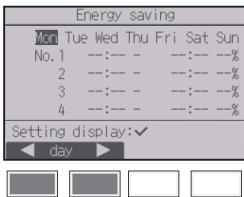

The screen to see the schedule will appear.

Press the **F1** or **F2** button to see the settings for each day of the week.

Press the **SELECT** button to go to the setting screen.



3

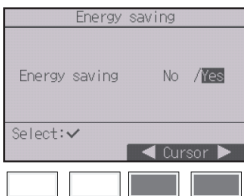

The screen to enable (Yes)/disable (No) the energy-saving operation schedule will appear.

Select “No” or “Yes” with the **F3** or **F4** button.

Press the **SELECT** button to go to the setting change/day of the week selection screen.



4

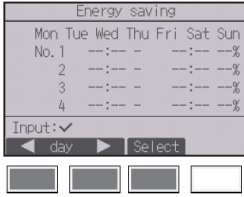

The setting change/day of the week selection screen will appear.

Up to four operation patterns can be set for each day.

Move the cursor to the desired day of the week with the **[F1]** or **[F2]** button, and press the **[F3]** button to select it. (Multiple days can be selected.)

Press the **[SELECT]** button to go to the pattern setting screen.

5

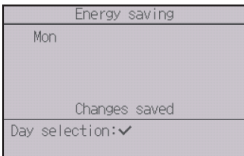
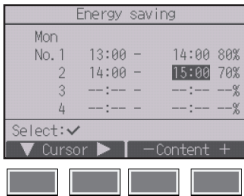

The pattern setting screen will appear.

Press the **[F1]** button to move the cursor to the desired pattern number.

Move the cursor to the desired item with the **[F2]** button out of the start time, stop time, and energy-saving rate (arranged in this order from the left).

Change the settings with the **[F3]** or **[F4]** button.

- Start/Stop time: settable in 5-minute increments
 - * Press and hold the button to rapidly advance the numbers.
- Energy-saving rate: The setting range is 0% and 50 to 90% in 10% increments.

Press the **[SELECT]** button to save the settings.

A confirmation screen will appear.

The lower the value, the greater the energy-saving effect.

Function settings

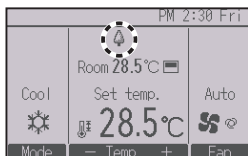

 will appear on the Main display in the Full mode when the unit is operated in the energy saving mode.

Navigating through the screens

- To go back to the setting change/day of the week selection screen **[SELECT]** button
- To go back to the Main menu **[MENU]** button
- To return to the previous screen **[RETURN]** button

Button operation

1

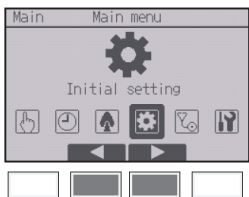

Select “Initial setting” from the Main menu (refer to page 20), and press the **[SELECT]** button.

Clock setting is required before making the following settings.

- On/Off timer
- OU silent mode
- Night setback
- Weekly timer
- Energy saving

If a given system has no system controllers, the clock time will not automatically be corrected. In this case, periodically correct the clock time.

2

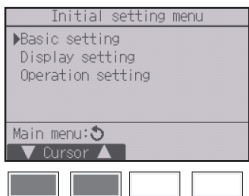

Move the cursor to “Basic setting” with the **[F1]** or **[F2]** button, and press the **[SELECT]** button.

3



Select “Clock” with the **[F1]** or **[F2]** button, and press the **[SELECT]** button.

Function settings

4



Move the cursor to “Clock” with the **[F1]** or **[F2]** button, and press the **[SELECT]** button.



5



Move the cursor to the desired item with the **[F1]** or **[F2]** button out of year, month, date, hour, or minute.

Increase or decrease the value for the selected item with the **[F3]** or **[F4]** button, and press the **[SELECT]** button.

A confirmation screen will appear.



Navigating through the screens

- To go back to the Main menu **[MENU]** button
- To return to the previous screen **[RETURN]** button

Function description

The start/end time for daylight saving time can be set. The daylight saving time function will be activated based on the setting contents.

- If a given system has a system controller, disable this setting to keep the correct time.
- At the beginning and the end of daylight saving time, the timer may go into action twice or not at all.
- This function will not work unless the clock has been set.

Button operation

1



The screenshot shows the 'Basic setting' menu with options: Main/Sub, Clock, and Administrator password. The 'Clock' option is selected. Below the menu, there are four status indicators: two grey and two white. Below the indicators are three buttons: a list icon, a back arrow, and a checkmark. To the right of the buttons is a power button icon.

Select "Clock" from the Basic setting menu, and press the **[SELECT]** button.

2



The screenshot shows the 'Clock menu' with options: Clock and Daylight saving time. The 'Daylight saving time' option is selected. Below the menu, there are four status indicators: two grey and two white. Below the indicators are three buttons: a list icon, a back arrow, and a checkmark. To the right of the buttons is a power button icon.

Move the cursor to "Daylight saving time" with the **[F1]** or **[F2]** button, and press the **[SELECT]** button.

Function settings

3

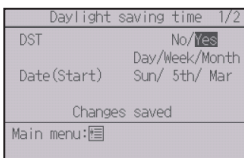
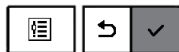
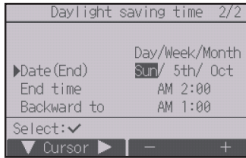
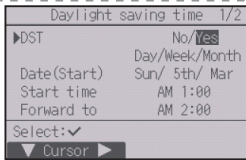

Move the cursor to the following items with the **[F1]** button to make the settings.

- **DST**
Select “No” (disable) or “Yes” (enable) with the **[F2]** button. The default setting is “No.”
 - **Date(Start)*1**
Set the day of the week, week number, and month with the **[F3]** or **[F4]** button. The default setting is “Sun/5th/Mar.”
 - **Start time**
Set the start time for daylight saving time with the **[F3]** or **[F4]** button.
 - **Forward to**
Set the time when the clock is to be set forward to at the start time above with the **[F3]** or **[F4]** button.
 - **Date(End)*1 (2nd page)**
Set the day of the week, week number, and month with the **[F3]** or **[F4]** button. The default setting is “Sun/5th/Oct.”
 - **End time (2nd page)**
Set the end time for daylight saving time with the **[F3]** or **[F4]** button.
 - **Backward to (2nd page)**
Set the time when the clock is to be set backward to at the end time above with the **[F3]** or **[F4]** button.
- *1 If “5th” is selected for the week number and the 5th week does not exist in the selected month of the year, the setting is considered to be “4th.”

Press the **[SELECT]** button to save the settings. A confirmation screen will appear.

Navigating through the screens

- To go back to the Main menu **[MENU]** button
- To return to the previous screen **[RETURN]** button

Button operation

1



Select “Display setting” from the Initial setting menu, and press the **[SELECT]** button.



2

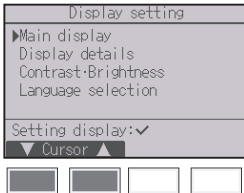

Move the cursor to “Main display” with the **[F1]** or **[F2]** button, and press the **[SELECT]** button.

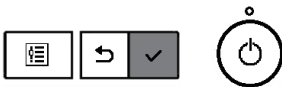

3

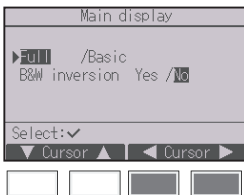

Select “Full” or “Basic” (refer to page 8) with the **[F3]** or **[F4]** button, and press the **[SELECT]** button.

A confirmation screen will appear.



Navigating through the screens

- To go back to the Main menu **[MENU]** button
- To return to the previous screen **[RETURN]** button

Function settings

Black and white inversion setting



Button operation

1

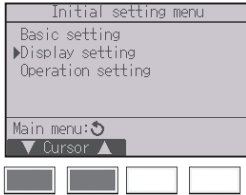

Select “Display setting” from the Initial setting menu, and press the **[SELECT]** button.



2

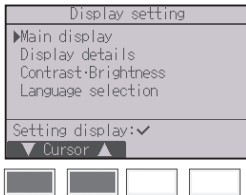

Move the cursor to “Main display” with the **[F1]** or **[F2]** button, and press the **[SELECT]** button.



3

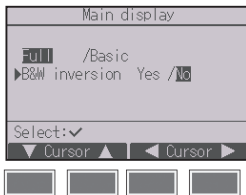

Select “B&W inversion” with the **[F1]** or **[F2]** button, and select the display mode “Yes” or “No” with the **[F3]** or **[F4]** button, and press the **[SELECT]** button. (The factory setting is “No.”)



Navigating through the screens

- To go back to the Main menu **[MENU]** button
- To return to the previous screen **[RETURN]** button

4

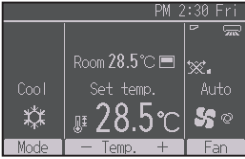

Selecting “Yes” will invert the colors of the display, turning white background to black and black characters to white as shown at left.

Function settings

Contrast•Brightness



Button operation

1

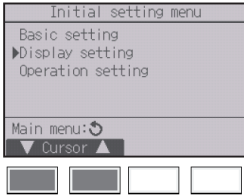

Select “Display setting” from the Initial setting menu, and press the **[SELECT]** button.



2

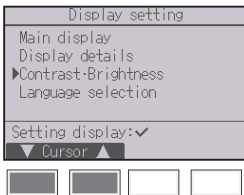

Move the cursor to “Contrast•Brightness” with the **[F1]** or **[F2]** button, and press the **[SELECT]** button.



3

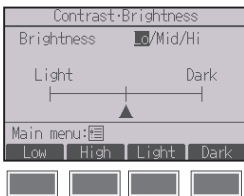

Adjust the brightness with the **[F1]** or **[F2]** button. Adjust the contrast with the **[F3]** or **[F4]** button, and press the **[MENU]** or **[RETURN]** button.



Navigating through the screens

- To go back to the Main menu **[MENU]** button
- To return to the previous screen **[RETURN]** button

Function description

The desired language can be set. The language options are English, French, German, Spanish, Italian, Portuguese, Swedish, Russian, Greek, Turkish, Dutch, Czech, Hungarian, and Polish.

Button operation

1



Select "Display setting" from the Initial setting menu, and press the **[SELECT]** button.



2

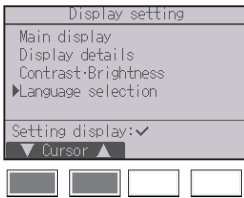

Move the cursor to "Language selection" with the **[F1]** or **[F2]** button, and press the **[SELECT]** button.



Function settings

3

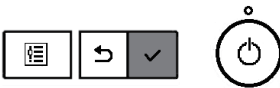

Move the cursor to the language you desire with the **[F1]** through **[F4]** buttons, and press the **[SELECT]** button to save the setting.

When the power is on for the first time, the Language selection screen will be displayed. Select a desired language. The system will not start-up without language selection.

A screen will appear that indicates the setting has been saved.

Navigating through the screens

- To go back to the Main menu **[MENU]** button
- To return to the previous screen **[RETURN]** button

Initialize remote controller



Function description

The remote controller can be initialized to the factory shipment state. Note that the following data will be initialized.

The remote controller will automatically be started up after being initialized.

Timer setting, Weekly timer setting, OU silent mode setting, Energy saving setting, Energy saving option setting, Main/Sub setting, Clock setting, Daylight saving time setting, Main display setting, Contrast•Brightness setting, Display details setting, Auto mode setting, Model name setting, Serial No. setting, Dealer information setting, Error information, Administrator password, Maintenance password

Button operation

1



Select "Others" from the Service menu, and press the **SELECT** button.



2



Move the cursor to "Initialize remote controller" with the **F1** or **F2** button, and press the **SELECT** button.



Function settings

3

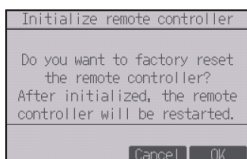

Select "OK" with the **[F4]** button.

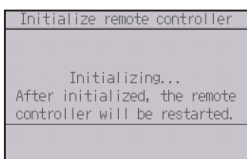
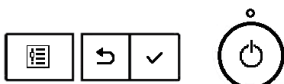

The remote controller will automatically be started up after being initialized.

Remote controller information



Function description

The information of the remote controller in use can be checked.

Button operation

1



Select "Others" from the Service menu, and press the **SELECT** button.



2



Move the cursor to "Remote controller information" with the **F1** or **F2** button, and press the **SELECT** button.



3

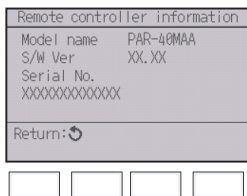

The model name, software version, and serial number of the remote controller in use can be checked.

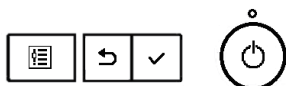

Troubleshooting

Error information

When an error occurs, the following screen will appear and the operation LED will blink. Check the error status, stop the operation, and consult your dealer.

Button operation

1

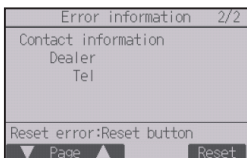
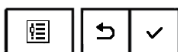
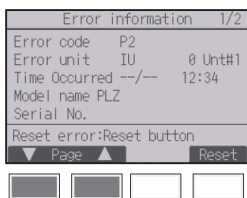

Error code, error unit, refrigerant address, unit model name, date and time on which an error occurred, and serial number will appear.

The model name and serial number will appear only if the information have been registered.

Press the **F1** or **F2** button to go to the next page.

Contact information (dealer's phone number) will appear if the information have been registered.

2

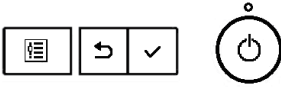
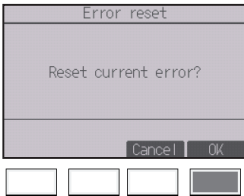
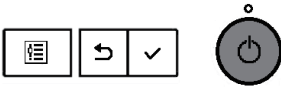
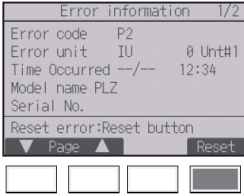

Press the **[F4]** button or the **[ON/OFF]** button to reset the error that is occurring.

Errors cannot be reset while the ON/OFF operation is prohibited.

Select "OK" with the **[F4]** button.

A confirmation screen will appear.

Navigating through the screens

- To go back to the Main menu **[MENU]** button

Troubleshooting

Checking the error information

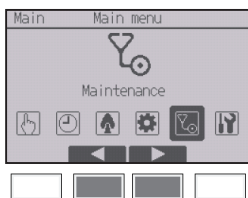

While no errors are occurring, page 2/2 of the error information (refer to page 66) can be viewed from the menu operation.

Select “Maintenance” menu from the Main menu, and press the **SELECT** button.

To display the error information screen, select “Error information” from the Maintenance menu.

Errors cannot be reset.

No occupancy Auto-OFF

The following screen will appear for the 3D i-See sensor panel model when the unit is stopped due to the No occupancy Auto-OFF function of the energy saving option. Refer to the indoor unit Instruction Book for the 3D i-See sensor setting.

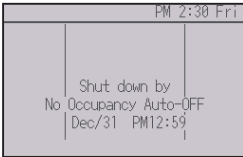

Maintenance

Filter information

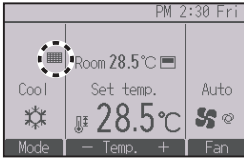

 will appear on the Main display in the Full mode when it is time to clean the filters.

Wash, clean, or replace the filters when this sign appears.

Refer to the indoor unit Instructions Manual for details.

Button operation

1



Select "Filter information" from the Maintenance menu, and press the **SELECT** button.



2



Press the **F4** button to reset filter sign.
Refer to the indoor unit Instructions Manual for how to clean the filter.

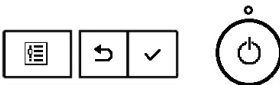

3

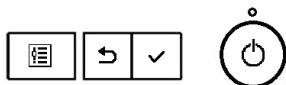



Select "OK" with the **[F4]** button.

A confirmation screen will appear.

Navigating through the screens

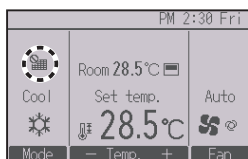
- To go back to the Main menu **[MENU]** button
- To return to the previous screen **[RETURN]** button



When the  is displayed on the Main display in the Full mode, the system is centrally controlled and the filter sign cannot be reset.

If two or more indoor units are connected, filter cleaning timing for each unit may be different, depending on the filter type.

The icon  will appear when the filter on the main unit is due for cleaning.

When the filter sign is reset, the cumulative operation time of all units will be reset.

The icon  is scheduled to appear after a certain duration of operation, based on the premise that the indoor units are installed in a space with ordinary air quality. Depending on the air quality, the filter may require more frequent cleaning.

The cumulative time at which filter needs cleaning depends on the model.

Specifications

Controller specifications

	Specification
Product size	120(W) × 120(H) × 14.5(D) mm (4 23/32 × 4 23/32 × 37/64 [in])
Net weight	0.19 kg (27/64 lbs)
Rated power supply voltage	12 VDC (supplied from indoor units)
Power consumption	0.3 W
Usage environment	Temperature 0 ~ 40°C (32 ~ 104°F) Humidity 25 ~ 90%RH (with no dew condensation)
Material	Main body: ABS

Function list (as of October 1, 2018)

○ : Supported × : Unsupported

	Function	CITY MULTI	Mr. SLIM	Required password
Power	Power ON/OFF	○	○	-
Settings	Operation mode	○	○	-
	Auto (dual set point) mode	○	○	-
	Preset temperature	○	○	-
	Fan speed	○	○	-
Operation menu	Vane•Louver•Vent. (Lossnay)	○	○	-
	High power	×	○	-
	Manual vane angle	○	○	-
	3D i-See sensor	○	○	-
Timer menu	Timer (On/Off timer)	○	○	administrator
	Timer (Auto-Off timer)	○	○	administrator
	Weekly timer	○	○	administrator
	OU silent mode	○	○	administrator
	Night setback	○	○	administrator
Energy saving menu	Temperature range restriction	○	○	administrator
	Operation lock function	○	○	administrator
	Auto return	○	○	administrator
	Schedule	×	○	administrator
Initial setting menu	Main/Sub	○	○	administrator
	Clock	○	○	administrator
	Clock display format setting	○	○	administrator
	Daylight saving time	○	○	administrator
	Main display	○	○	administrator
	Black and white inversion	○	○	administrator
	Contrast•Brightness	○	○	administrator
	Language selection	○	○	administrator
	Password (Administrator)	○	○	administrator
Service menu	Initialize remote controller	○	○	maintenance
	Remote controller information	○	○	maintenance
	Test run	○	○	maintenance
	Model information input	○	○	maintenance
	Dealer information input	○	○	maintenance
	Function setting	○	○	maintenance
	Smooth maintenance	×	○	maintenance
	Password (Maintenance)	○	○	maintenance
Maintenance menu	Auto descending panel	○	○	-
	Error information	○	○	-
	Filter information	○	○	-

* The supported functions vary depending on the unit model.

Specifications

List of functions that can/cannot be used in combination

	High power	On/Off timer	Auto-off timer	Weekly timer	OU silent mode	Temperature range	Operation lock	Auto return	Energy saving schedule	Night setback
High power		○	○	○	△1	○	△2	○	△1	○
On/Off timer	○		○	×1	○	○	○	○	○	△3
Auto-off timer	○	○		○	○	○	○	○	○	△4
Weekly timer	○	×1	○		○	○	○	○	○	△5
OU silent mode	△1	○	○	○		○	○	○	○	○
Temperature range	○	○	○	○	○		○	×2	○	△6
Operation lock	△2	○	○	○	○	○		○	○	○
Auto return	○	○	○	○	○	×2	○		○	△7
Energy saving schedule	△1	○	○	○	○	○	○	○		○
Night setback	○	△3	△4	△5	○	△6	○	△7	○	

○ : Can be used in combination × : Cannot be used in combination △ : Restricted

- △ 1: This function is enabled after completing the high power operation because the high power operation has the higher priority.
- △ 2: This function cannot be operated if some operation is locked.
- △ 3: Night setback function cannot be used when the unit is in operation by On/Off timer setting.
- △ 4: Auto-off function cannot be used for Night setback operation.
- △ 5: Night setback function cannot be used when the unit is in operation by Weekly timer setting.
- △ 6: Temperature range setting cannot be used for Night setback operation.
- △ 7: Auto return function cannot be used for Night setback operation.

- × 1: Weekly timer setting is not effective because On/Off timer has the higher priority.
- × 2: Auto return function cannot be used because Temperature range setting has the higher priority.

This product is designed and intended for use in the residential, commercial, and light-industrial environment.

The product at hand is based on the following EU regulations:

- Electromagnetic Compatibility Directive 2014/30/EU

MITSUBISHI ELECTRIC CORPORATION

HEAD OFFICE: TOKYO BLDG. , 2-7-3, MARUNOUCHI, CHIYODA-KU, TOKYO 100-8310, JAPAN
MANUFACTURER: MITSUBISHI ELECTRIC CORPORATION Air-conditioning & Refrigeration Systems Works
5-66, Tebira 6 Chome, Wakayama-city, 640-8686, Japan

WT09014X01_en