

Service Manual

Air Conditioner

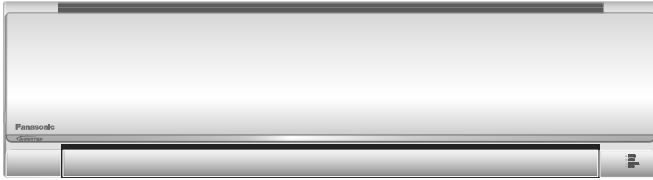

Indoor Unit
CS-RE18RKEW
CS-RE24RKEW

Outdoor Unit
CU-RE18RKE
CU-RE24RKE

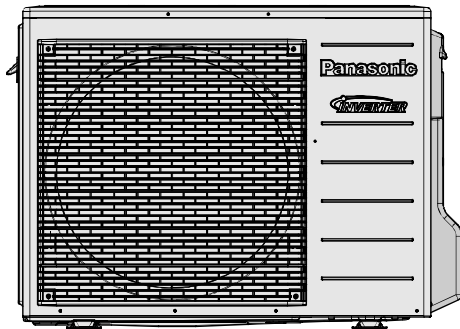

Destination
Europe
L.America
Turkey

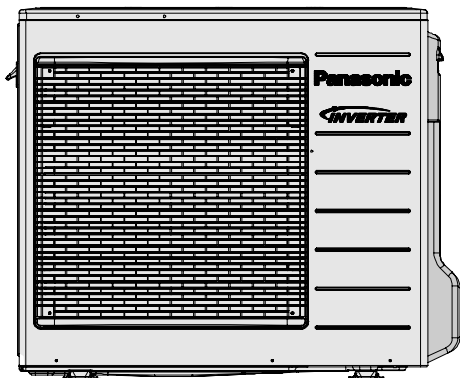

WARNING

This service information is designed for experienced repair technicians only and is not designed for use by the general public. It does not contain warnings or cautions to advise non-technical individuals of potential dangers in attempting to service a product. Products powered by electricity should be serviced or repaired only by experienced professional technicians. Any attempt to service or repair the product or products dealt with in this service information by anyone else could result in serious injury or death.

IMPORTANT SAFETY NOTICE

There are special components used in this equipment which are important for safety. These parts are marked by  in the Schematic Diagrams, Circuit Board Diagrams, Exploded Views and Replacement Parts List. It is essential that these critical parts should be replaced with manufacturer's specified parts to prevent shock, fire or other hazards. Do not modify the original design without permission of manufacturer.

PRECAUTION OF LOW TEMPERATURE



In order to avoid frostbite, be assured of no refrigerant leakage during the installation or repairing of refrigerant circuit.

TABLE OF CONTENTS

1. Safety Precautions	3
2. Specifications	5
3. Features.....	8
4. Location of Controls and Components.....	9
4.1 Indoor Unit.....	9
4.2 Outdoor Unit	9
4.3 Remote Control	9
5. Dimensions	10
5.1 Indoor Unit & Remote Control	10
5.2 Outdoor Unit	11
6. Refrigeration Cycle Diagram	13
7. Block Diagram	15
7.1 CS-RE18RKEW CU-RE18RKE.....	15
7.2 CS-RE24RKEW CU-RE24RKE.....	16
8. Wiring Connection Diagram	17
8.1 Indoor Unit.....	17
8.2 Outdoor Unit	18
9. Electronic Circuit Diagram	20
9.1 Indoor Unit.....	20
9.2 Outdoor Unit	21
10. Printed Circuit Board	23
10.1 Indoor Unit.....	23
10.2 Outdoor Unit	24
11. Installation Instruction	27
11.1 Select the Best Location.....	27
11.2 Indoor Unit.....	28
11.3 Outdoor Unit	33
12. Operation and Control	36
12.1 Basic Function	36
12.2 Airflow Direction.....	38
12.3 Timer Control.....	40
12.4 Auto Restart Control	40
12.5 Indication Panel.....	40
12.6 Quiet Operation (Cooling Mode/Cooling Area of Dry Mode).....	41
12.7 Quiet Operation (Heating)	41
12.8 Powerful Mode Operation.....	41
13. Protection Control.....	42
13.1 Protection Control For All Operations.....	42
13.2 Protection Control For Cooling & Soft Dry Operation.....	44
13.3 Protection Control For Heating Operation..	45
14. Servicing Mode	47
14.1 Auto OFF/ON Button	47
14.2 Remote Control Button.....	48
15. Troubleshooting Guide	49
15.1 Refrigeration Cycle System.....	49
15.2 Relationship Between The Condition Of The Air Conditioner And Pressure And Electric Current.....	50
15.3 Breakdown Self Diagnosis Function.....	51
15.4 Error Codes Table	52
15.5 Self-diagnosis Method.....	54
16. Disassembly and Assembly Instructions	82
16.1 Indoor Electronic Controllers, Cross Flow Fan and Indoor Fan Motor Removal Procedures	82
16.2 Outdoor Electronic Controller Removal Procedure	87
17. Technical Data	89
17.1 Cool Mode Performance Data.....	89
17.2 Heat Mode Performance Data.....	90
18. Service Data	91
18.1 Cool Mode Outdoor Air Temperature Characteristic.....	91
18.2 Heat Mode Outdoor Air Temperature Characteristic.....	93
18.3 Piping Length Correction Factor.....	95
19. Exploded View and Replacement Parts List..	96
19.1 Indoor Unit.....	96
19.2 Outdoor Unit	99

1. Safety Precautions







- Read the following “SAFETY PRECAUTIONS” carefully before perform any servicing.
- Electrical work must be installed or serviced by a licensed electrician. Be sure to use the correct rating of the power plug and main circuit for the model installed.
- The caution items stated here must be followed because these important contents are related to safety. The meaning of each indication used is as below. Incorrect installation or servicing due to ignoring of the instruction will cause harm or damage, and the seriousness is classified by the following indications.

 WARNING	This indication shows the possibility of causing death or serious injury.
 CAUTION	This indication shows the possibility of causing injury or damage to properties.

- The items to be followed are classified by the symbols:

	This symbol denotes item that is PROHIBITED from doing.
---	---

- Carry out test run to confirm that no abnormality occurs after the servicing. Then, explain to user the operation, care and maintenance as stated in instructions. Please remind the customer to keep the operating instructions for future reference.

 WARNING	
1.	Do not modify the machine, part, material during repairing service.
2.	If wiring unit is supplied as repairing part, do not repair or connect the wire even only partial wire break. Exchange the whole wiring unit.
3.	Do not wrench the fasten terminal. Pull it out or insert it straightly.
4.	Engage dealer or specialist for installation and servicing. If installation of servicing done by the user is defective, it will cause water leakage, electrical shock or fire.
5.	Install according to this installation instructions strictly. If installation is defective, it will cause water leakage, electric shock or fire.
6.	Use the attached accessories parts and specified parts for installation and servicing. Otherwise, it will cause the set to fall, water leakage, fire or electrical shock.
7.	Install at a strong and firm location which is able to withstand the set's weight. If the strength is not enough or installation is not properly done, the set will drop and cause injury.
8.	For electrical work, follow the local national wiring standard, regulation and the installation instruction. An independent circuit and single outlet must be used. If electrical circuit capacity is not enough or defect found in electrical work, it will cause electrical shock or fire.
9.	This equipment is strongly recommended to install with Earth Leakage Circuit Breaker (ELCB) or Residual Current Device (RCD). Otherwise, it may cause electrical shock and fire in case equipment breakdown or insulation breakdown.
10.	Do not use joint cable for indoor / outdoor connection cable. Use the specified Indoor/Outdoor connection cable, refer to installation instruction CONNECT THE CABLE TO THE INDOOR UNIT and connect tightly for indoor / outdoor connection. Clamp the cable so that no external force will be acted on the terminal. If connecting or fixing is not perfect, it will cause heat up or fire at the connection.
11.	Wire routing must be properly arranged so that control board cover is fixed properly. If control board cover is not fixed perfectly, it will cause heat-up or fire at the connection point of terminal, fire or electrical shock.
12.	When install or relocate air conditioner, do not let any substance other than the specified refrigerant, eg. air etc. mix into refrigeration cycle (piping). (Mixing of air etc. will cause abnormal high pressure in refrigeration cycle and result in explosion, injury etc.)
13.	Do not install outdoor unit near handrail of veranda. When installing air-conditioner unit at veranda of high rise building, child may climb up to outdoor unit and cross over the handrail and causing accident.
14.	This equipment must be properly earthed. Earth line must not be connected to gas pipe, water pipe, earth of lightning rod and telephone. Otherwise, it may cause electric shock in case equipment breakdown or insulation breakdown. 
15.	Keep away from small children, the thin film may cling to nose and mouth and prevent breathing. 
16.	Do not use unspecified cord, modified cord, joint cord or extension cord for power supply cord. Do not share the single outlet with other electrical appliances. Poor contact, poor insulation or over current will cause electrical shock or fire. 
17.	Tighten the flare nut with torque wrench according to specified method. If the flare nut is over-tightened, after a long period, the flare may break and cause refrigerant gas leakage. 
18.	<ul style="list-style-type: none"> • For R410A model, use piping, flare nut and tools which is specified for R410A refrigerant. Using of existing (R22) piping, flare nut and tools may cause abnormally high pressure in the refrigerant cycle (piping), and possibly result in explosion and injury. • Thickness of copper pipes used with R410A must be more than 0.8 mm. Never use copper pipes thinner than 0.8 mm. • It is desirable that the amount of residual oil less than 40 mg/10 m. 
19.	During installation, install the refrigerant piping properly before run the compressor. (Operation of compressor without fixing refrigeration piping and valves at opened condition will caused suck-in of air, abnormal high pressure in refrigeration cycle and result in explosion, injury etc).

⚠ WARNING

- | | | |
|-----|---|---|
| 20. | During pump down operation, stop the compressor before remove the refrigeration piping. (Removal of compressor while compressor is operating and valves are opened will cause suck-in of air, abnormal high pressure in refrigeration cycle and result in explosion, injury etc.) | |
| 21. | After completion of installation or service, confirm there is no leakage or refrigerant gas. It may generate toxic gas when the refrigerant contacts with fire. | |
| 22. | Ventilate if there is refrigerant gas leakage during operation. It may cause toxic gas when refrigerant contacts with fire. | |
| 23. | Do not insert your fingers or other objects into the unit, high speed rotating fan may cause injury. | ⊘ |
| 24. | Must not use other parts except original parts described in catalog and manual. | |
| 25. | Using of refrigerant other than the specified type may cause product damage, burst and injury etc. | |

⚠ CAUTION

- | | | |
|-----|---|---|
| 1. | Do not install the unit at place where leakage of flammable gas may occur. In case gas leaks and accumulates at surrounding of the unit, it may cause fire. | ⊘ |
| 2. | Carry out drainage piping as mentioned in installation instructions. If drainage is not perfect, water may enter the room and damage the furniture. | |
| 3. | Tighten the flare nut with torque wrench according to specified method. If the flare nut is over-tightened, after a long period, the flare may break and cause refrigerant gas leakage. | |
| 4. | Do not touch outdoor unit air inlet and aluminium fin. It may cause injury. | ⊘ |
| 5. | Select an installation location which is easy for maintenance. | |
| 6. | Pb free solder has a higher melting point than standard solder; typically the melting point is 50°F – 70°F (30°C – 40°C) higher. Please use a high temperature solder iron. In case of the soldering iron with temperature control, please set it to 700 ± 20°F (370 ± 10°C). Pb free solder will tend to splash when heated too high (about 1100°F / 600°C). | |
| | Power supply connection to the room air conditioner.
Use power supply cord 3 × 1.5 mm ² (1.0 ~ 1.75HP), 3 × 2.5 mm ² (2.0 ~ 2.5HP) type designation 60245 IEC 57 or heavier cord.
Connect the power supply cord of the air conditioner to the mains using one of the following method.
Power supply point should be in easily accessible place for power disconnection in case of emergency.
In some countries, permanent connection of this air conditioner to the power supply is prohibited. | |
| 7. | 1) Power supply connection to the receptacle using power plug.
Use an approved 15/16A (1.0 ~ 1.75HP), 16A (2.0HP), 20A (2.5HP) power plug with earth pin for the connection to the socket.
2) Power supply connection to a circuit breaker for the permanent connection.
Use an approved 16A (1.0 ~ 2.0HP), 20A (2.5HP) circuit breaker for the permanent connection. It must be a double pole switch with a minimum 3.0 mm contact gap. | |
| 8. | Do not release refrigerant during piping work for installation, servicing, reinstallation and during repairing a refrigerant parts. Take care of the liquid refrigerant, it may cause frostbite. | ⊘ |
| 9. | Installation or servicing work: It may need two people to carry out the installation or servicing work. | |
| 10. | Do not install this appliance in a laundry room or other location where water may drip from the ceiling, etc. | ⊘ |
| 11. | Do not sit or step on the unit, you may fall down accidentally. | ⊘ |
| 12. | Do not touch the sharp aluminium fins or edges of metal parts.
If you are required to handle sharp parts during installation or servicing, please wear hand glove.
Sharp parts may cause injury. | ⊘ |

2. Specifications

Model		Indoor	CS-RE18RKEW			CS-RE24RKEW				
		Outdoor	CU-RE18RKE			CU-RE24RKE				
Performance Test Condition			EUROVENT			EUROVENT				
Power Supply		Phase, Hz	Single, 50			Single, 50				
		V	230			230				
			Min.	Mid.	Max.	Min.	Mid.	Max.		
Cooling	Capacity		kW	0.98	5.00	6.00	0.98	6.80	8.10	
			BTU/h	3340	17100	20500	3340	23200	27600	
			Kcal/h	840	4300	5160	840	5850	6970	
	Running Current		A	–	6.60	–	–	9.60	–	
	Input Power		W	280	1.47k	2.03k	380	2.10k	2.67k	
	Annual Consumption		kWh	–	735	–	–	1050	–	
	EER		W/W	3.50	3.40	2.96	2.58	3.24	3.03	
			BTU/hW	11.93	11.63	10.10	8.79	11.05	10.34	
			Kcal/hW	3.00	2.93	2.54	2.21	2.79	2.61	
	ErP	Pdesign		kW	5.0			6.8		
		SEER		(W/W)	6.7			6.0		
		Annual Consumption		kWh	261			397		
		Class			A++			A+		
	Power Factor		%	–	97	–	–	95	–	
	Indoor Noise (H/L/QLo)		dB-A	44 / 37 / 34			47 / 38 / 35			
			Power Level dB	60 / 53 / 50			63 / 54 / 51			
	Outdoor Noise		dB-A	47			52			
Power Level dB			61			66				
Heating	Capacity		kW	0.98	5.80	8.00	0.98	8.60	9.90	
			BTU/h	3340	19800	27300	3340	29300	33800	
			Kcal/h	840	4990	6880	840	7400	8510	
	Running Current		A	–	6.90	–	–	11.70	–	
	Input Power		W	340	1.54k	2.60k	450	2.61k	3.13k	
	COP		W/W	2.88	3.77	3.08	2.18	3.30	3.16	
			BTU/hW	9.82	12.86	10.50	7.42	11.23	10.80	
			Kcal/hW	2.47	3.24	2.65	1.87	2.84	2.72	
	ErP	Pdesign		kW	4.4			5.5		
		Tbivalent		°C	-10			-10		
		SCOP		(W/W)	4.1			3.8		
		Annual Consumption		kWh	1502			2026		
		Class			A+			A		
	Power Factor		%	–	97	–	–	97	–	
	Indoor Noise (H/L/QLo)		dB-A	44 / 37 / 34			47 / 38 / 35			
			Power Level dB	60 / 53 / 50			63 / 54 / 51			
	Outdoor Noise		dB-A	47			52			
Power Level dB			61			66				
Low Temp. : Capacity (kW) / I.Power (W) / COP			5.80 / 2.35k / 2.47			7.17 / 2.77k / 2.59				
Extr Low Temp. : Capacity (kW) / I.Power (W) / COP			4.98 / 2.41k / 2.07			6.13 / 2.75k / 2.23				
Max Current (A) / Max Input Power (W)			11.4 / 2.60k			14.5 / 3.13k				
Starting Current (A)			6.90			11.70				

Model			Indoor	CS-RE18RKEW	CS-RE24RKEW	
			Outdoor	CU-RE18RKE	CU-RE24RKE	
Compressor	Type			Hermetic Motor (Rotary)	Hermetic Motor (Rotary)	
	Motor Type			Brushless (4-poles)	Brushless (4-poles)	
	Output Power		W	900	1.70k	
Indoor Fan	Type			Cross-Flow Fan	Cross-Flow Fan	
	Material			ASG20K1	ASG20K1	
	Motor Type			DC / Transistor (8 poles)	DC / Transistor (8 poles)	
	Input Power		W	94.8	94.8	
	Output Power		W	40	60	
	Speed	QLo	Cool	rpm	880	900
			Heat	rpm	990	990
		Lo	Cool	rpm	960	1000
			Heat	rpm	1070	1090
		Me	Cool	rpm	1080	1230
			Heat	rpm	1190	1280
		Hi	Cool	rpm	1200	1460
			Heat	rpm	1310	1480
	SHi	Cool	rpm	1390	1490	
Heat		rpm	1430	1520		
Outdoor Fan	Type			Propeller Fan	Propeller Fan	
	Material			PP	PP	
	Motor Type			DC (8-poles)	DC (8-poles)	
	Input Power		W	-	-	
	Output Power		W	40	60	
	Speed	Hi	Cool	rpm	600	660
			Heat	rpm	600	640
Moisture Removal			L/h (Pt/h)	2.8 (5.9)	3.9 (8.2)	
Indoor Airflow	QLo	Cool	m ³ /min (ft ³ /min)	11.37 (402)	10.61 (375)	
		Heat	m ³ /min (ft ³ /min)	13.05 (461)	12.38 (437)	
	Lo	Cool	m ³ /min (ft ³ /min)	12.59 (445)	12.00 (424)	
		Heat	m ³ /min (ft ³ /min)	14.28 (504)	13.84 (489)	
	Me	Cool	m ³ /min (ft ³ /min)	14.43 (510)	15.20 (537)	
		Heat	m ³ /min (ft ³ /min)	16.11 (569)	16.67 (589)	
	Hi	Cool	m ³ /min (ft ³ /min)	16.3 (575)	18.4 (650)	
		Heat	m ³ /min (ft ³ /min)	17.9 (630)	19.5 (690)	
SHi	Cool	m ³ /min (ft ³ /min)	19.17 (677)	18.82 (665)		
	Heat	m ³ /min (ft ³ /min)	19.78 (699)	20.08 (709)		
Outdoor Airflow	Hi	Cool	m ³ /min (ft ³ /min)	39.2 (1385)	50.2 (1770)	
		Heat	m ³ /min (ft ³ /min)	37.9 (1340)	50.2 (1770)	
Refrigeration Cycle	Control Device			Expansion Valve	Expansion Valve	
	Refrigerant Oil		cm ³	FV50S (450)	FV50S (800)	
	Refrigerant Type		g (oz)	R410A, 1.19k (42.0)	R410A, 1.80k (63.5)	
Dimension	Height (I/D / O/D)		mm (inch)	290 (11-7/16) / 695 (27-3/8)	290 (11-7/16) / 795 (31-5/16)	
	Width (I/D / O/D)		mm (inch)	1070 (42-5/32) / 875 (34-15/32)	1070 (42-5/32) / 875 (34-15/32)	
	Depth (I/D / O/D)		mm (inch)	240 (9-15/32) / 320 (12-5/8)	240 (9-15/32) / 320 (12-5/8)	
Weight	Net (I/D / O/D)		kg (lb)	12 (26) / 46 (101)	12 (26) / 67 (148)	

Model		Indoor	CS-RE18RKEW		CS-RE24RKEW	
		Outdoor	CU-RE18RKE		CU-RE24RKE	
Piping	Pipe Diameter (Liquid / Gas)	mm (inch)	6.35 (1/4) / 12.70 (1/2)		6.35 (1/4) / 15.88 (5/8)	
	Standard length	m (ft)	5.0 (16.4)		5.0 (16.4)	
	Length range (min – max)	m (ft)	3 (9.8) ~ 20 (65.6)		3 (9.8) ~ 30 (98.4)	
	I/D & O/D Height different	m (ft)	15.0 (49.2)		20 (65.6)	
	Additional Gas Amount	g/m (oz/ft)	20 (0.2)		30 (0.3)	
	Length for Additional Gas	m (ft)	7.5 (24.6)		10 (32.8)	
Drain Hose	Inner Diameter	mm	16.7		16.7	
	Length	mm	650		650	
Indoor Heat Exchanger	Fin Material		Aluminium (Pre Coat)		Aluminium (Pre Coat)	
	Fin Type		Slit Fin		Slit Fin	
	Row × Stage × FPI		2 × 15 × 17		2 × 15 × 21	
	Size (W × H × L)	mm	810 × 315 × 25.4		810 × 315 × 25.4	
Outdoor Heat Exchanger	Fin Material		Aluminium (Pre Coat)		Aluminium (Pre Coat)	
	Fin Type		Corrugated Fin		Corrugated Fin	
	Row × Stage × FPI		2 × 31 × 19		2 × 30 × 19	
	Size (W × H × L)	mm	36.4 × 651 × 854.5:824.5		38.1 × 762 × 895.8:865.8	
Air Filter	Material		Polypropelene		Polypropelene	
	Type		One-touch		One-touch	
Power Supply			Outdoor		Outdoor	
Power Supply Cord		A	Nil		Nil	
Thermostat			Nil		Nil	
Protection Device			Electronic Contol		Electronic Contol	
			Dry Bulb	Wet Bulb	Dry Bulb	Wet Bulb
Indoor Operation Range	Cooling	Maximum °C	32	23	32	23
		Minimum °C	16	11	16	11
	Heating	Maximum °C	30	–	30	–
		Minimum °C	16	–	16	–
Outdoor Operation Range	Cooling	Maximum °C	43	26	43	26
		Minimum °C	-10	–	-10	–
	Heating	Maximum °C	24	18	24	18
		Minimum °C	-15	-16	-15	-16

- Cooling capacities are based on indoor temperature of 27°C Dry Bulb (80.6°F Dry Bulb), 19.0°C Wet Bulb (66.2°F Wet Bulb) and outdoor air temperature of 35°C Dry Bulb (95°F Dry Bulb), 24°C Wet Bulb (75.2°F Wet Bulb)
- Heating capacities are based on indoor temperature of 20°C Dry Bulb (68°F Dry Bulb) and outdoor air temperature of 7°C Dry Bulb (44.6°F Dry Bulb), 6°C Wet Bulb (42.8°F Wet Bulb)
- Heating low temperature capacity, Input Power and COP measured at 230 V, indoor temperature of 20°C, outdoor 2/1°C.
- Heating extreme low temperature capacity, Input Power and COP measured at 230 V, indoor temperature of 20°C, outdoor -7/-8°C.
- Standby power consumption ≤ 2.0W (when switched OFF by remote control, except under self-protection control).
- Specifications are subjected to change without prior notice for further improvement.
- Maximum heating capacity shown are the values based on powerful operation.
- If the EUROVENT Certified models can be operated under the “extra-low” temperature condition, -7°C DB and -8°C WB temperature with rated voltage 230V shall be used.
- The annual consumption is calculated by multiplying the input power by an average of 500 hours per year in cooling mode.
- SEER and SCOP classification is at 230V only in accordance with EN-14825. For heating, SCOP indicates the value of only Average heating season. Other fiche data indicates in an attached sheet.

3. Features

- **Inverter Technology**
 - Wider output range
 - Energy saving
 - More precise temperature control
- **Environment Protection**
 - Non-ozone depletion substances refrigerant (R410A)
- **Long Installation Piping**
 - CS-RE18RKEW / CU-RE18RKE, long piping up to 20 meter
 - CS-RE24RKEW / CU-RE24RKE, long piping up to 30 meter
- **Easy to use remote control**
- **Quality Improvement**
 - Random auto restart after power failure for safety restart operation
 - Gas leakage protection
 - Prevent compressor reverse cycle
 - Inner protector to protect compressor
 - Noise prevention during soft dry operation
- **Serviceability Improvement**
 - Breakdown Self Diagnosis function

4. Location of Controls and Components

4.1 Indoor Unit

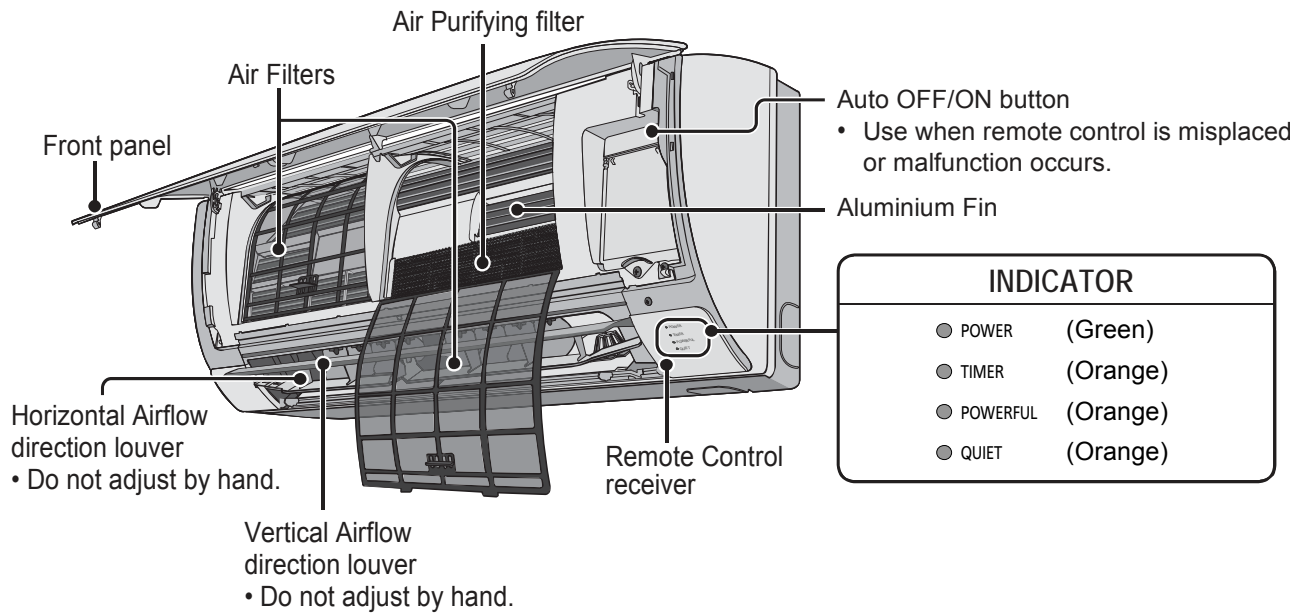

4.2 Outdoor Unit

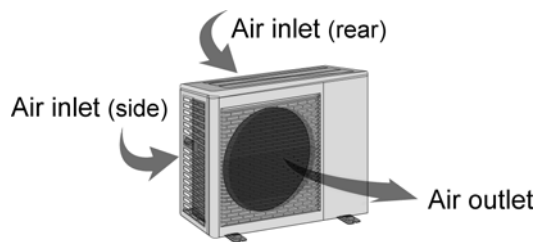

4.3 Remote Control

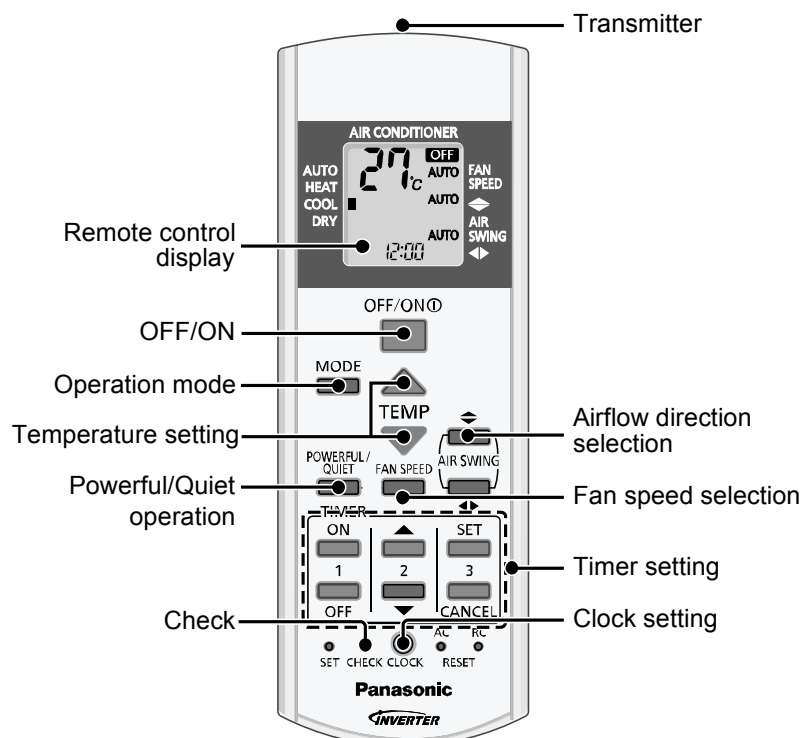

5. Dimensions

5.1 Indoor Unit & Remote Control

<Top View>

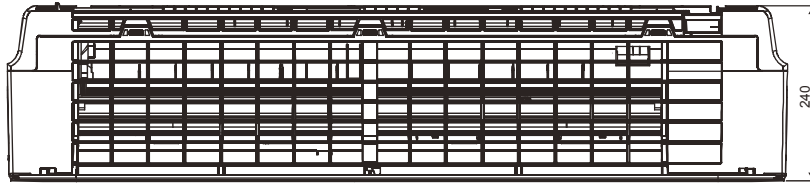

<Side View>

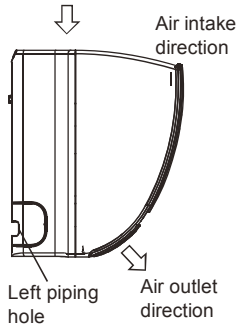

<Front View>

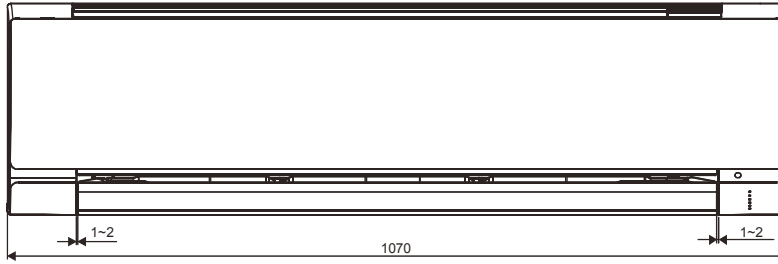

<Side View>

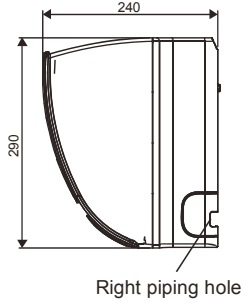

<Bottom View>

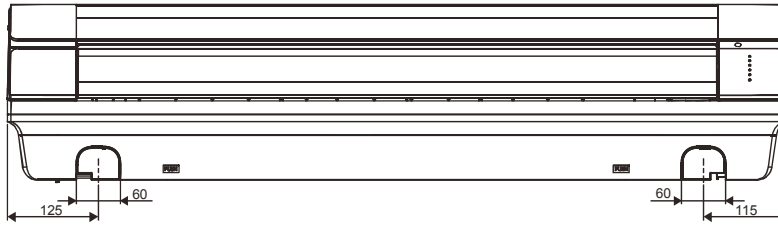

<Remote Control Transmitter>

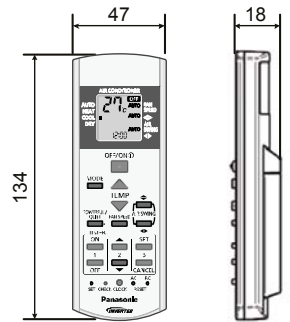

<Back View>

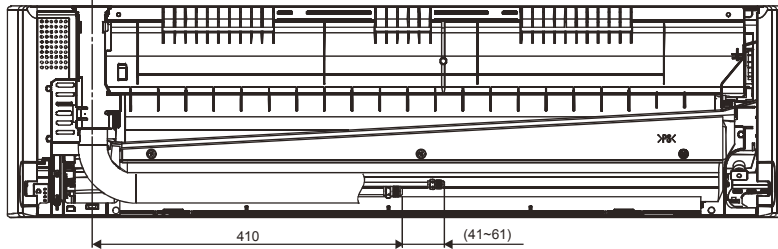

<Remote Control Holder>

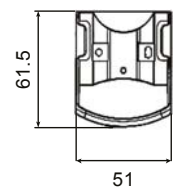

Relative position between the indoor unit and the installation plate <Front View>

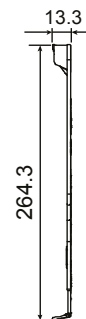
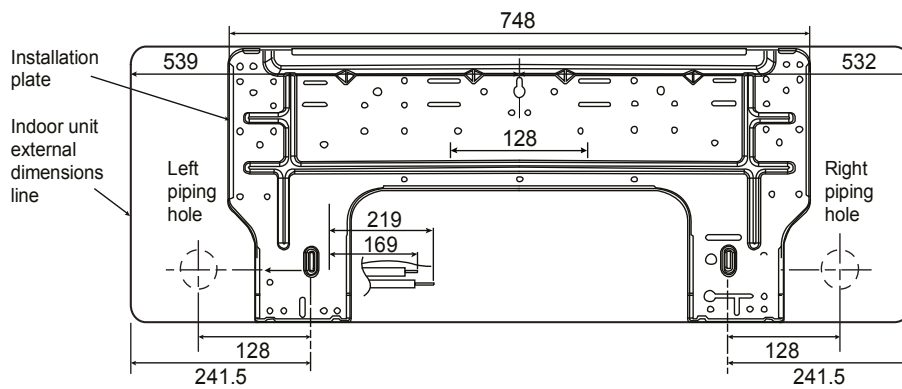

Unit : mm

5.2 Outdoor Unit

5.2.1 CU-RE18RKE

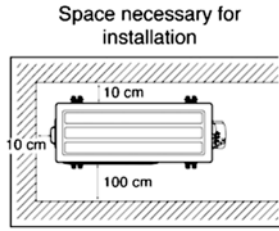

Anchor Bolt Pitch
360.5 x 613

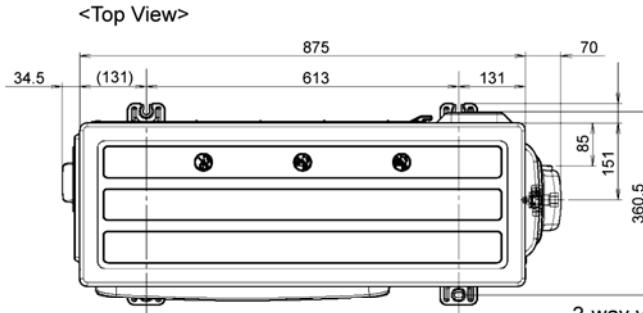

2-way valve at Liquid side
(High Pressure)
3-way valve at Gas side
(Low Pressure)

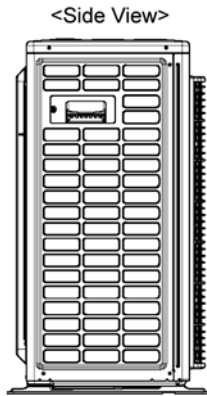

Unit: mm

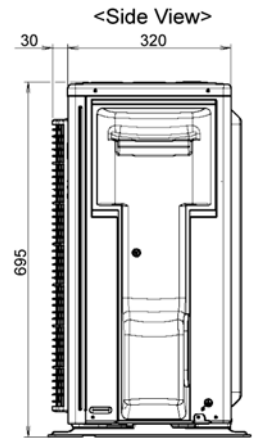
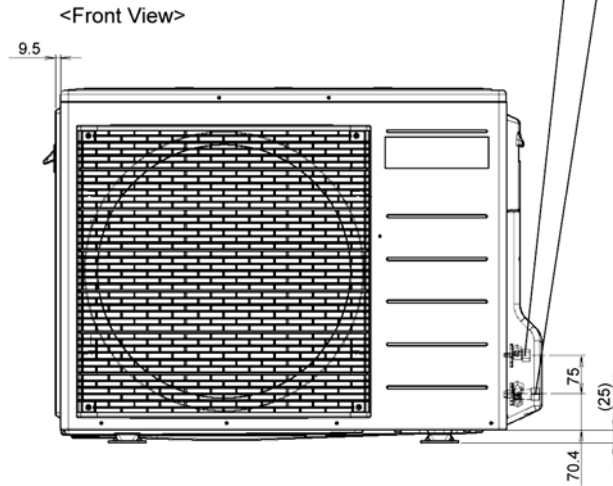

5.2.2 CU-RE24RKE

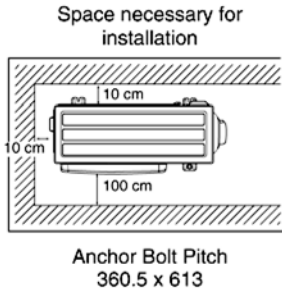

<Top View>

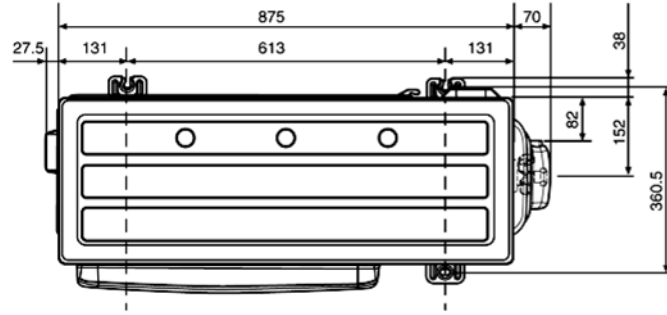

<Side View>

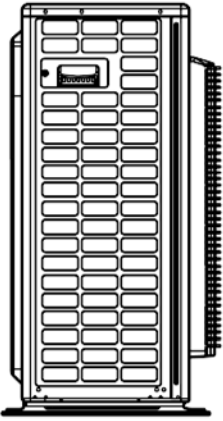

<Front View>

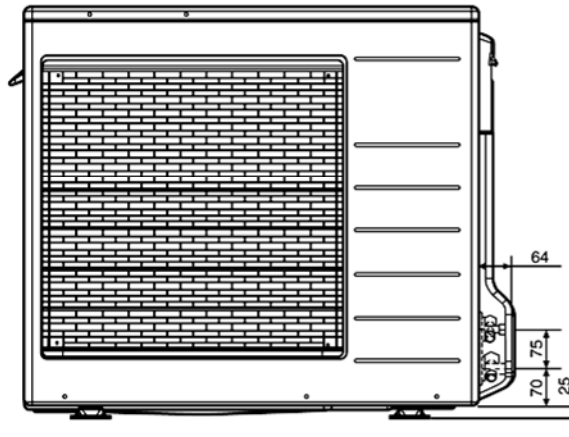

<Side View>

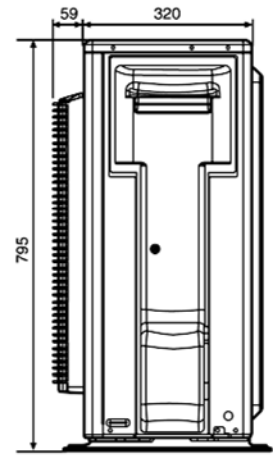

Unit : mm

6. Refrigeration Cycle Diagram

6.1.1 CS-RE18RKEW CU-RE18RKE

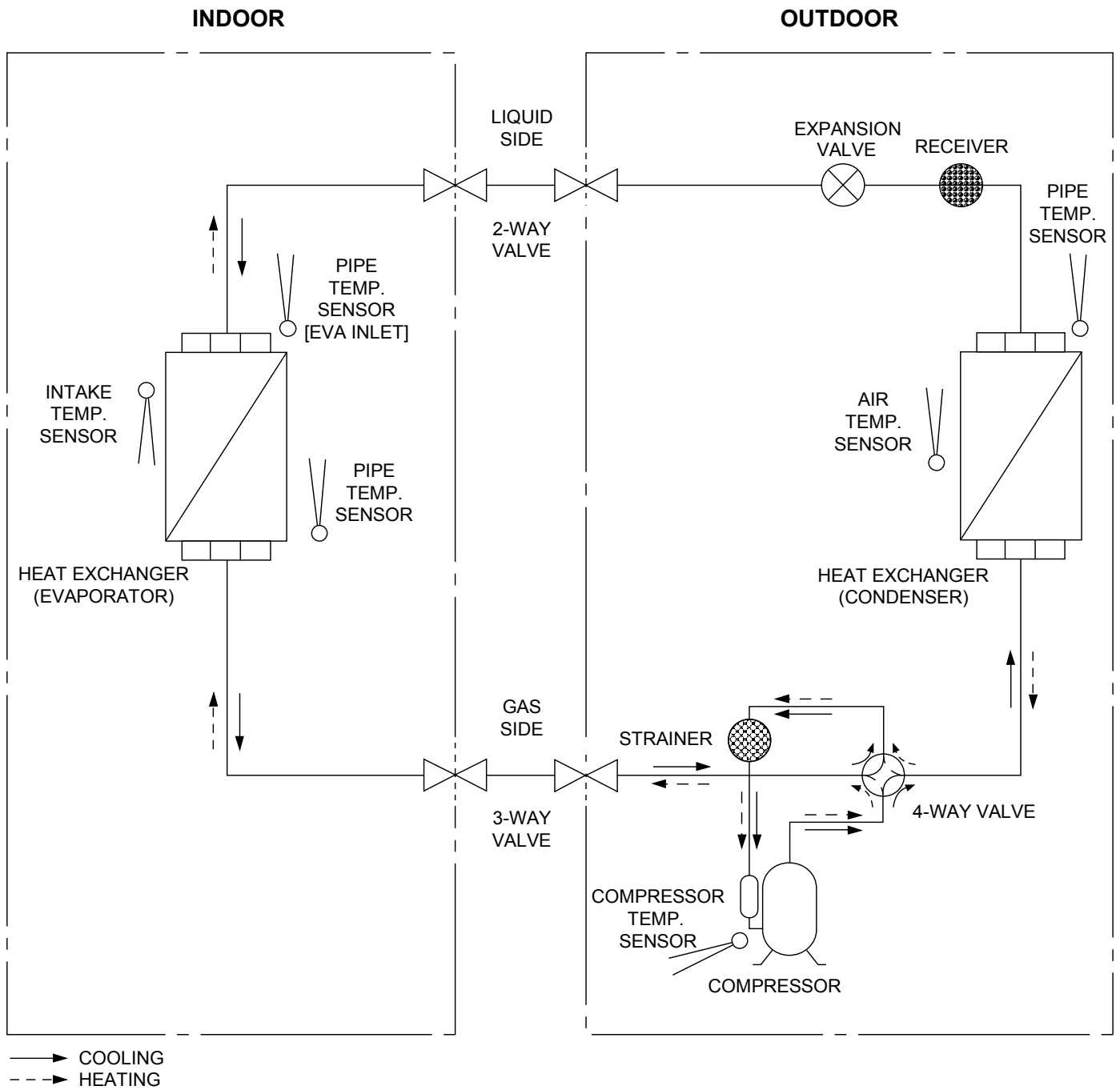

6.1.2 CS-RE24RKEW CU-RE24RKE

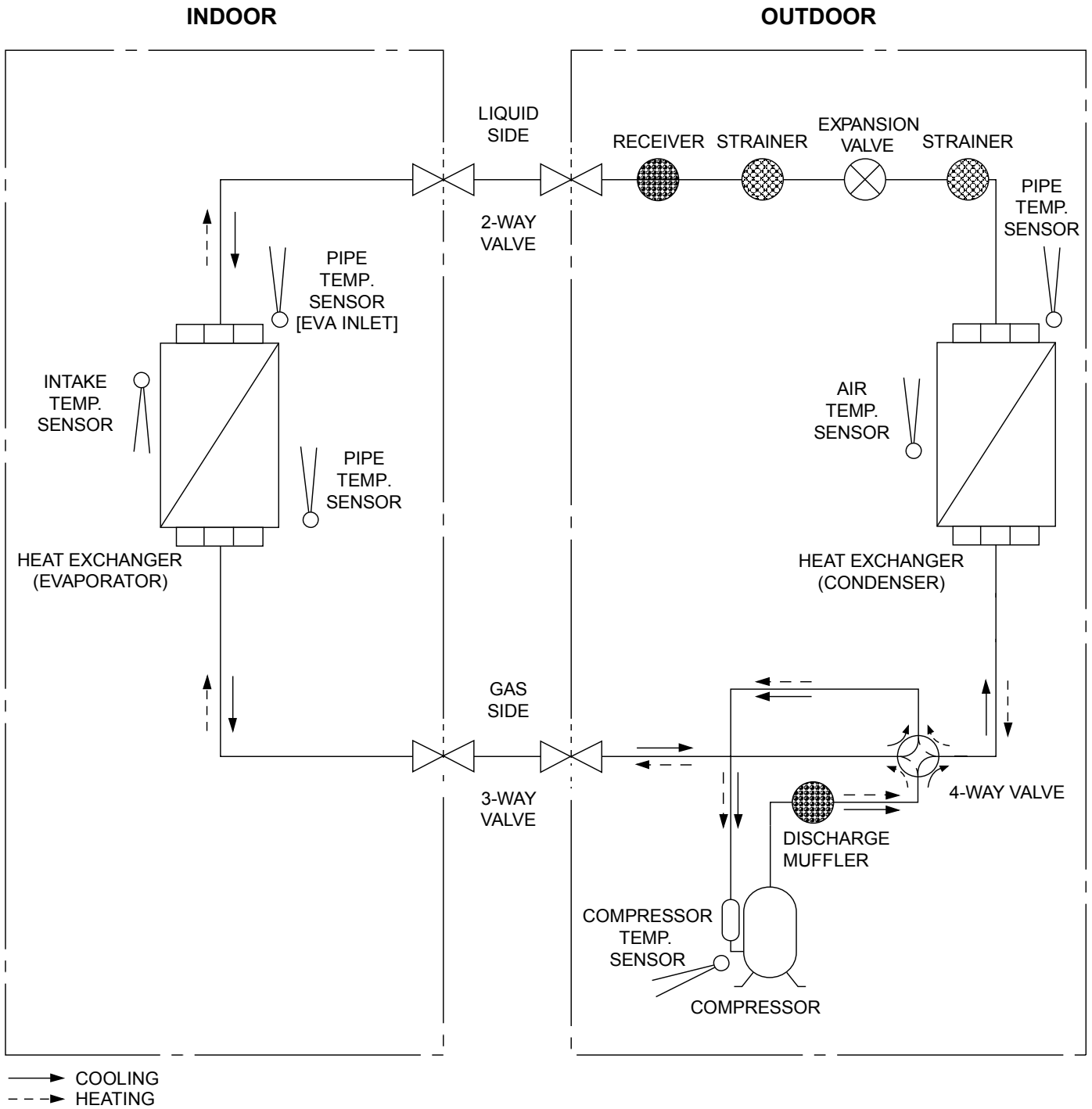

7. Block Diagram

7.1 CS-RE18RKEW CU-RE18RKE

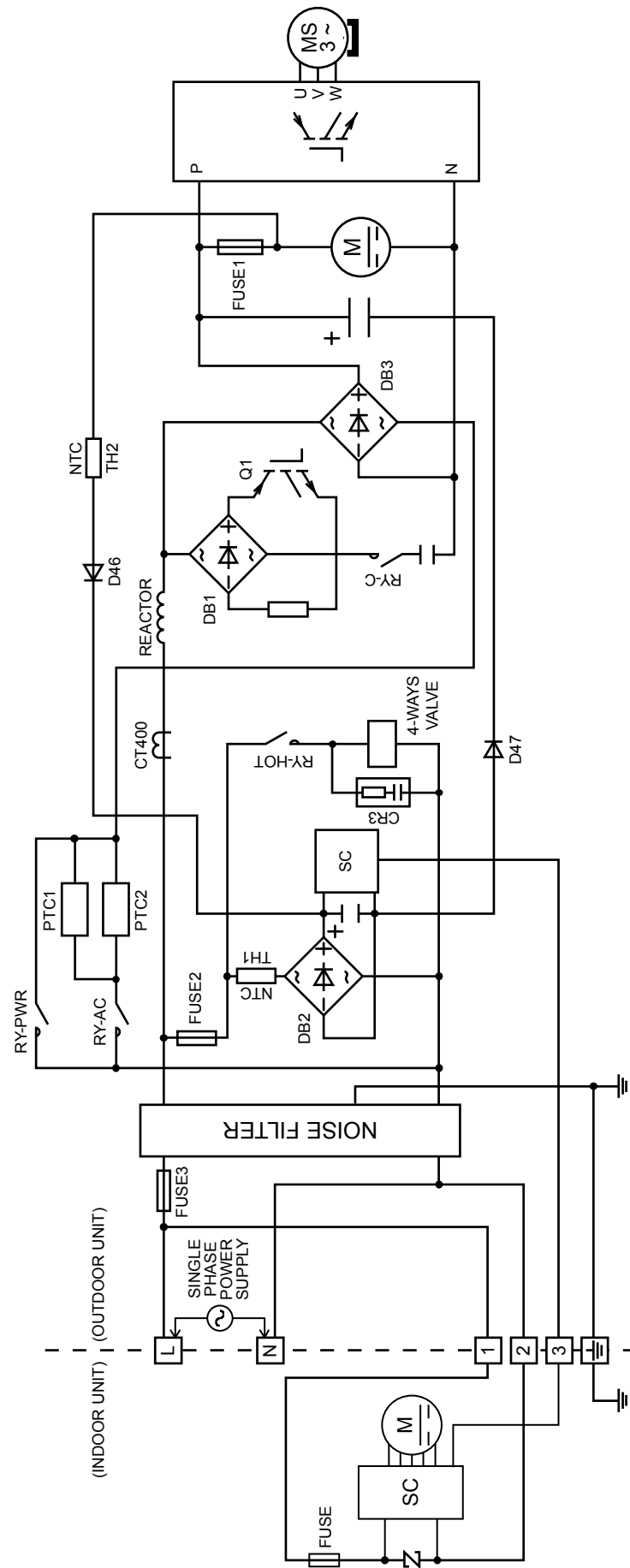

7.2 CS-RE24RKEW CU-RE24RKE

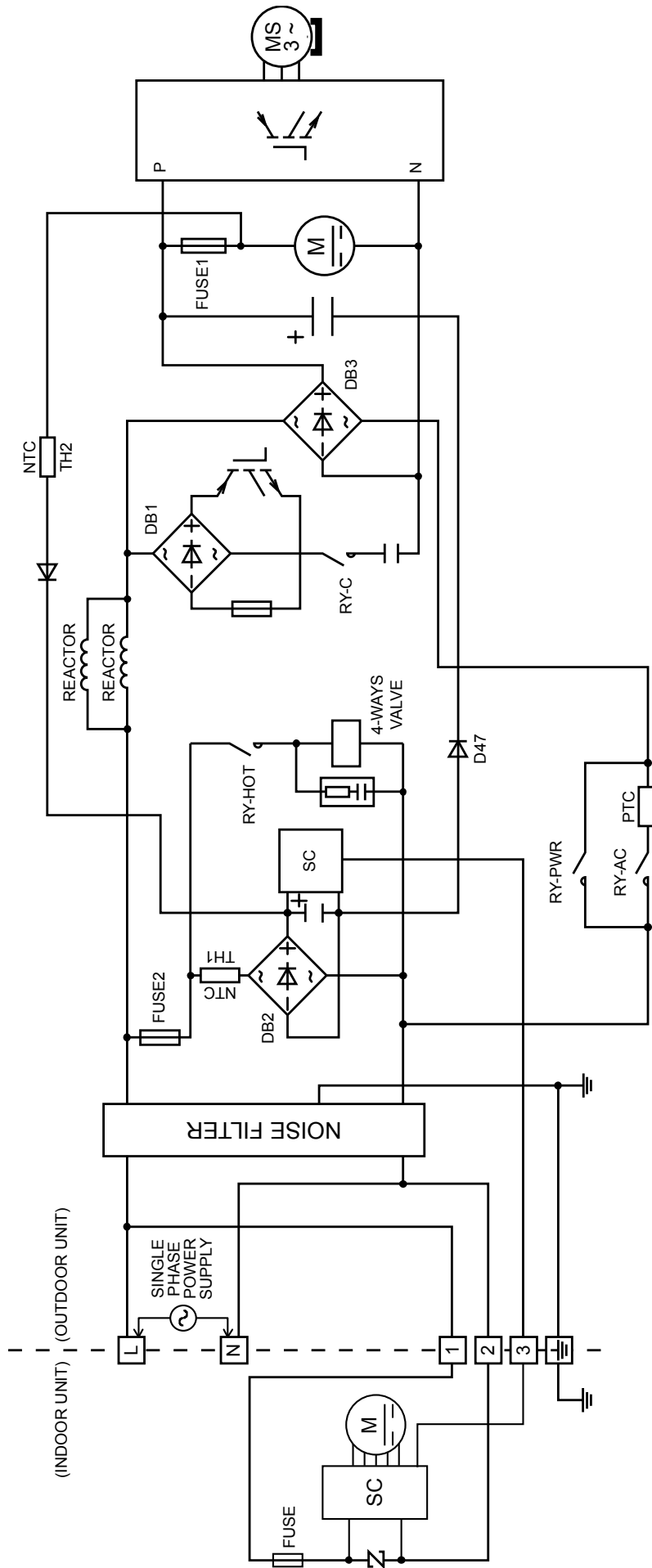

8. Wiring Connection Diagram

8.1 Indoor Unit

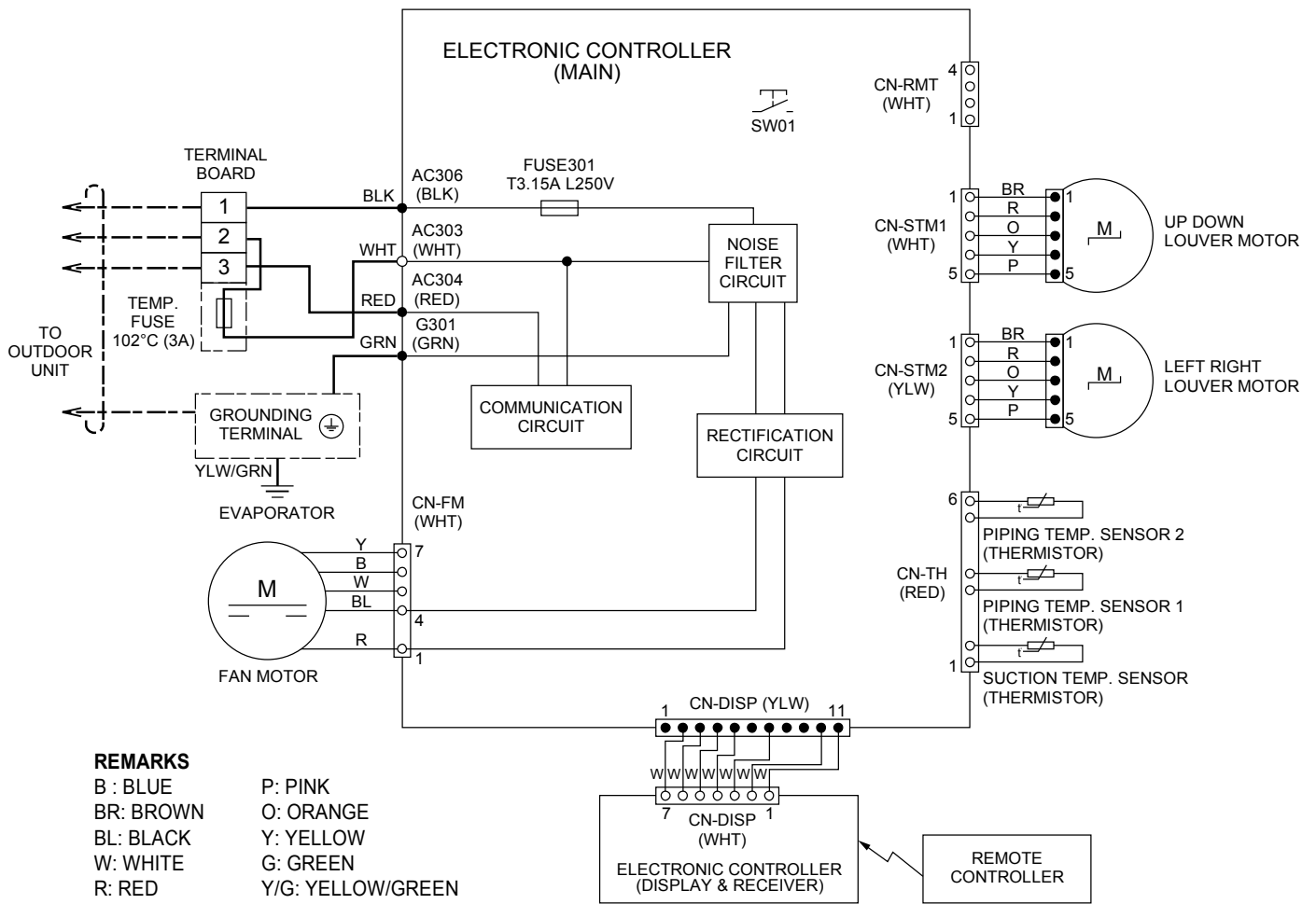

8.2 Outdoor Unit

8.2.1 CU-RE18RKE

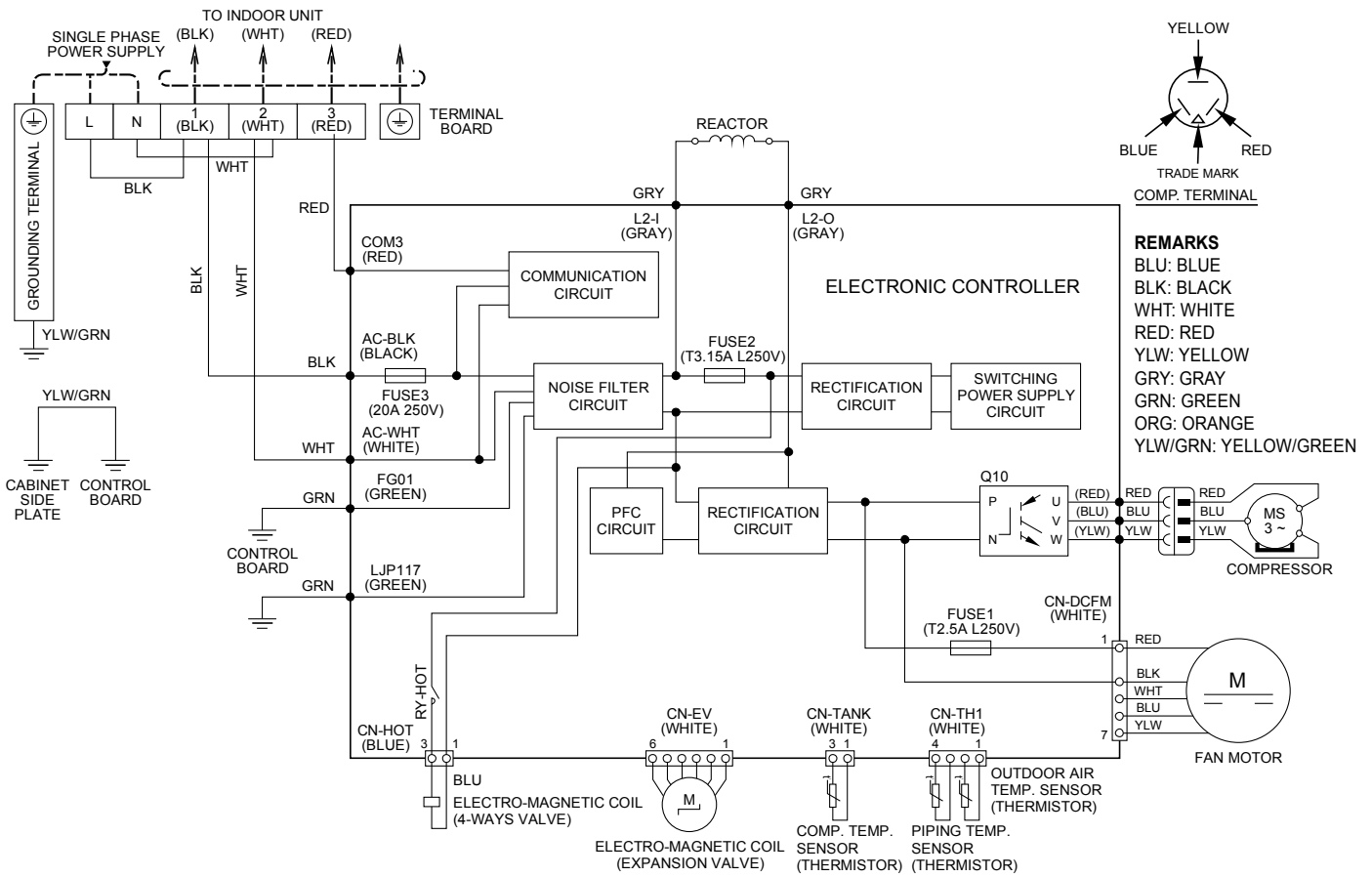

Resistance of Compressor Windings

MODEL	CU-RE18RKE
CONNECTION	5RD132XBA21
U-V	1.897 Ω
U-W	1.882 Ω
V-W	1.907 Ω

Note: Resistance at 20°C of ambient temperature.

8.2.2 CU-RE24RKE

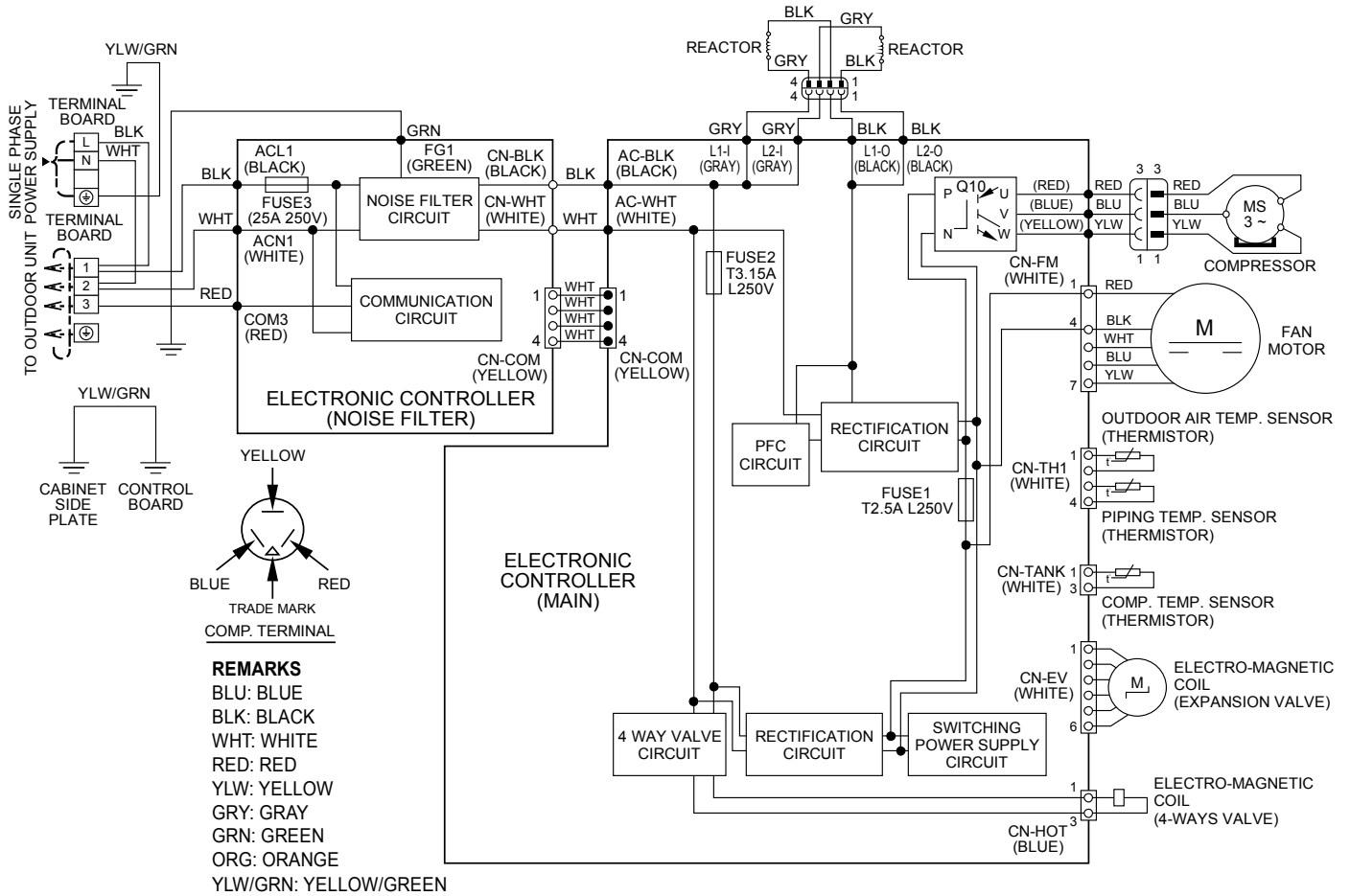

Resistance of Compressor Windings

MODEL	CU-RE24RKE
CONNECTION	5KD240XAF21
U-V	0.720 Ω
U-W	0.726 Ω
V-W	0.708 Ω

Note: Resistance at 20°C of ambient temperature.

9. Electronic Circuit Diagram

9.1 Indoor Unit

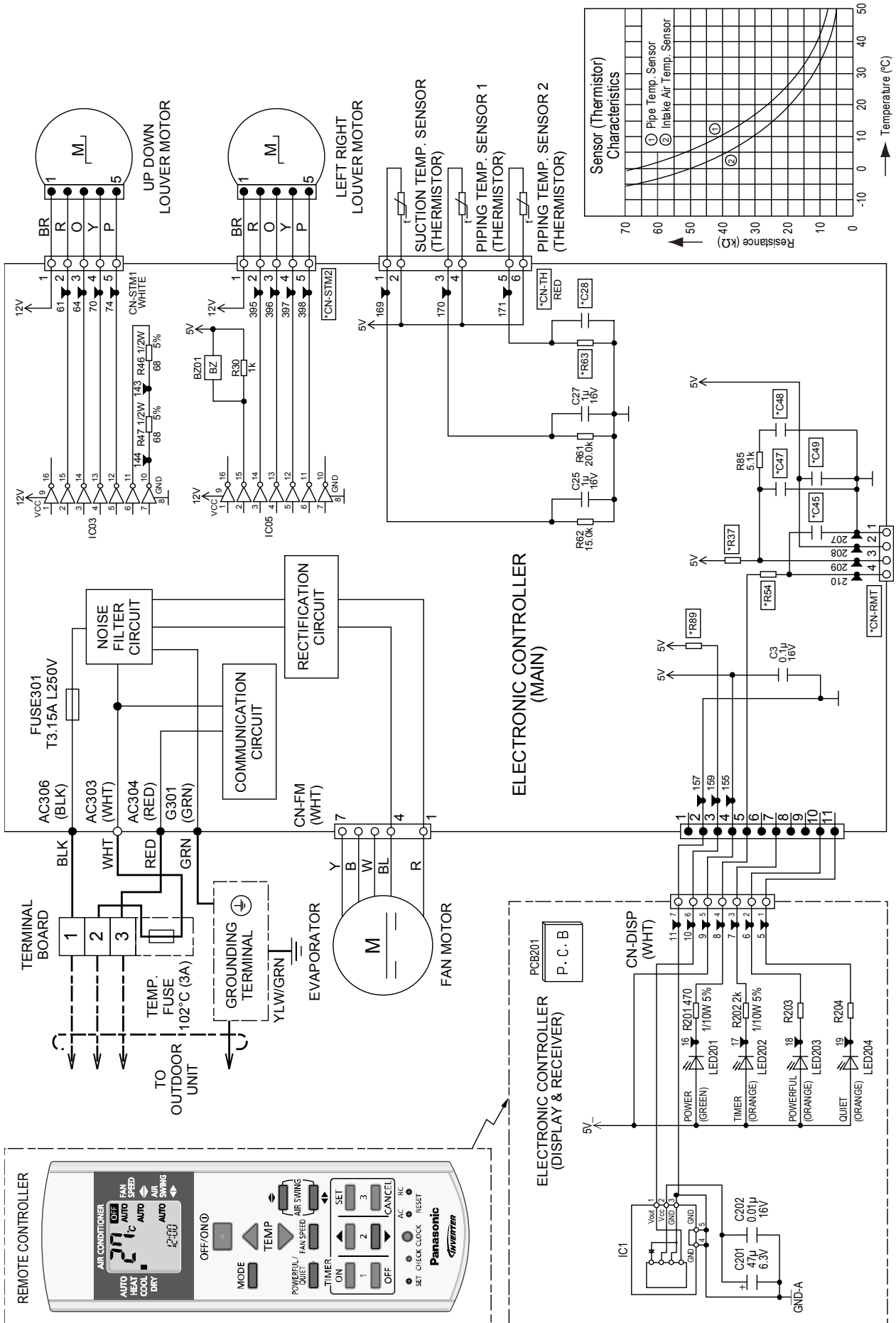

9.2 Outdoor Unit

9.2.1 CU-RE18RKE

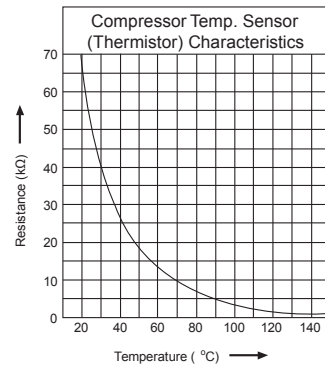
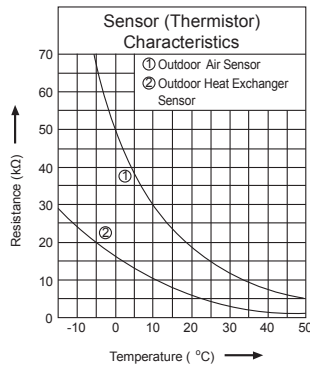
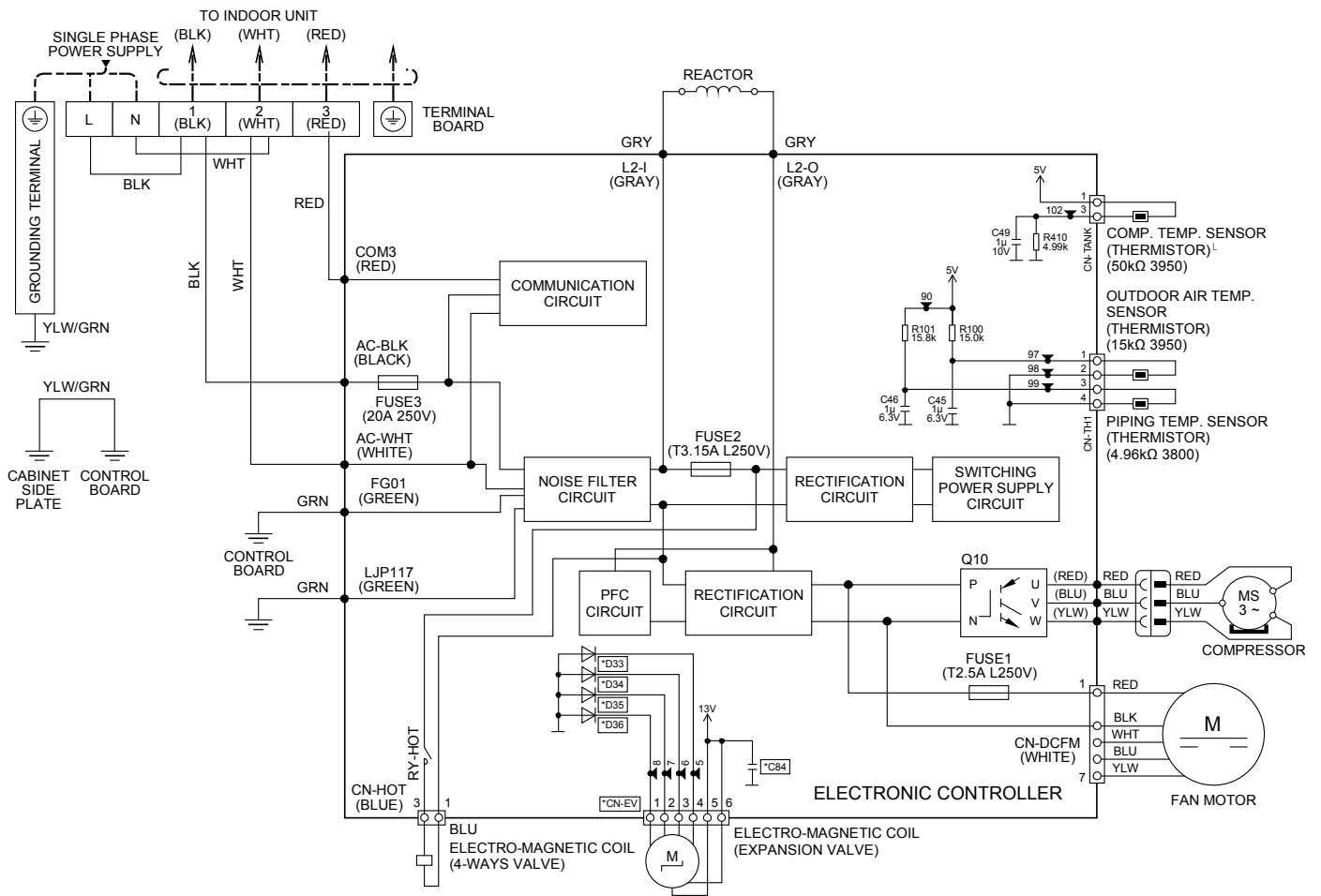

9.2.2 CU-RE24RKE

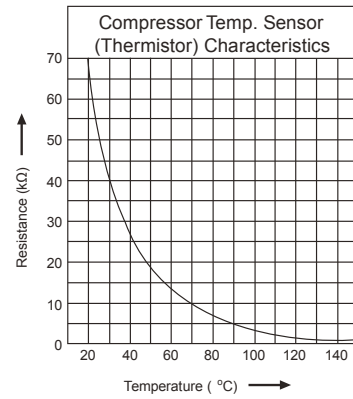
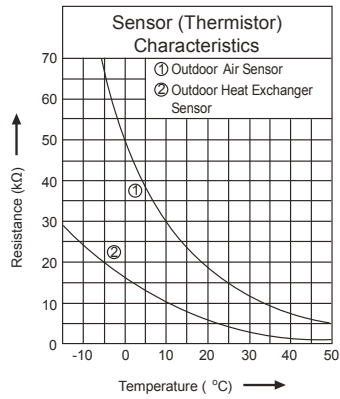
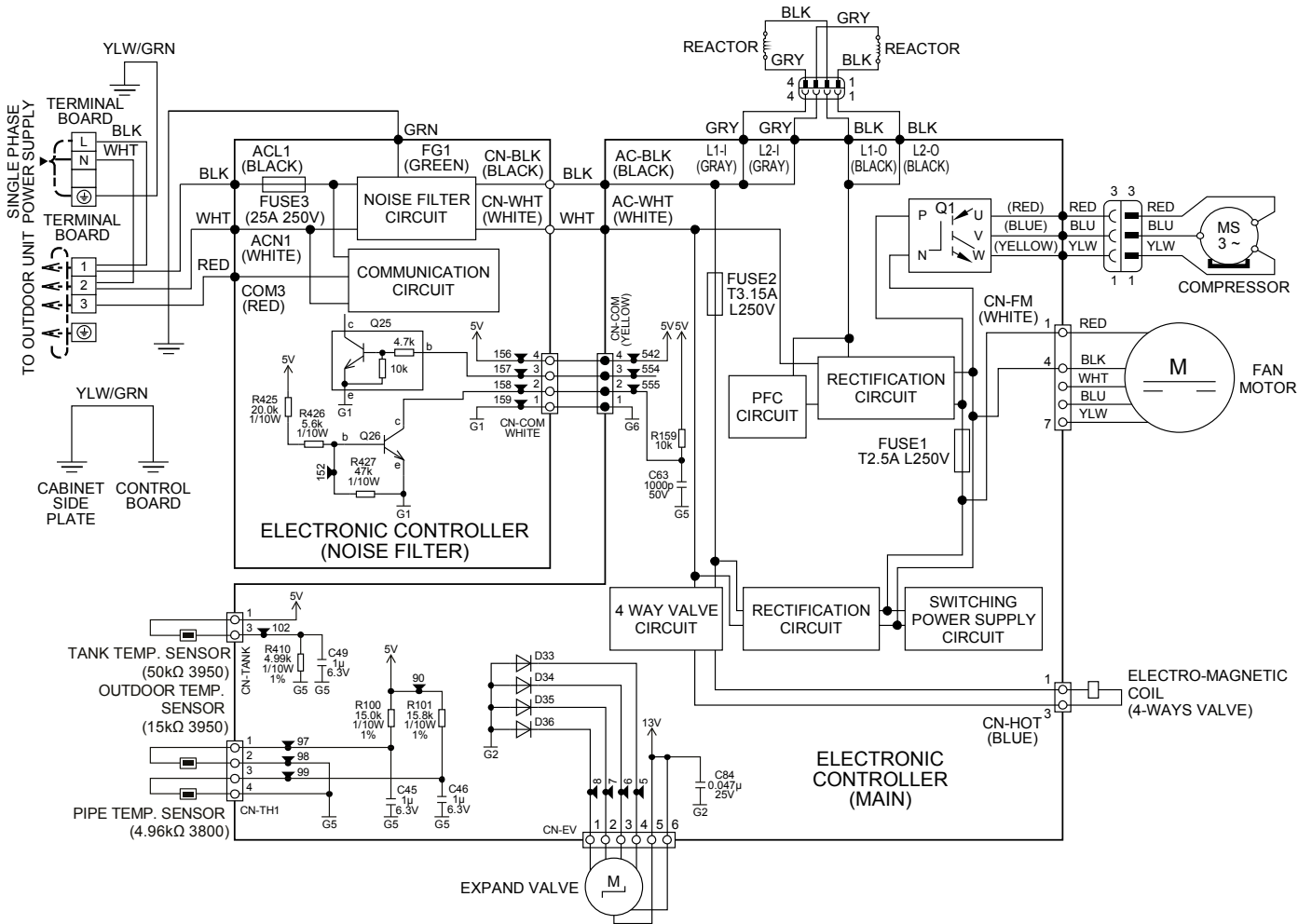

10. Printed Circuit Board

10.1 Indoor Unit

10.1.1 Main Printed Circuit Board

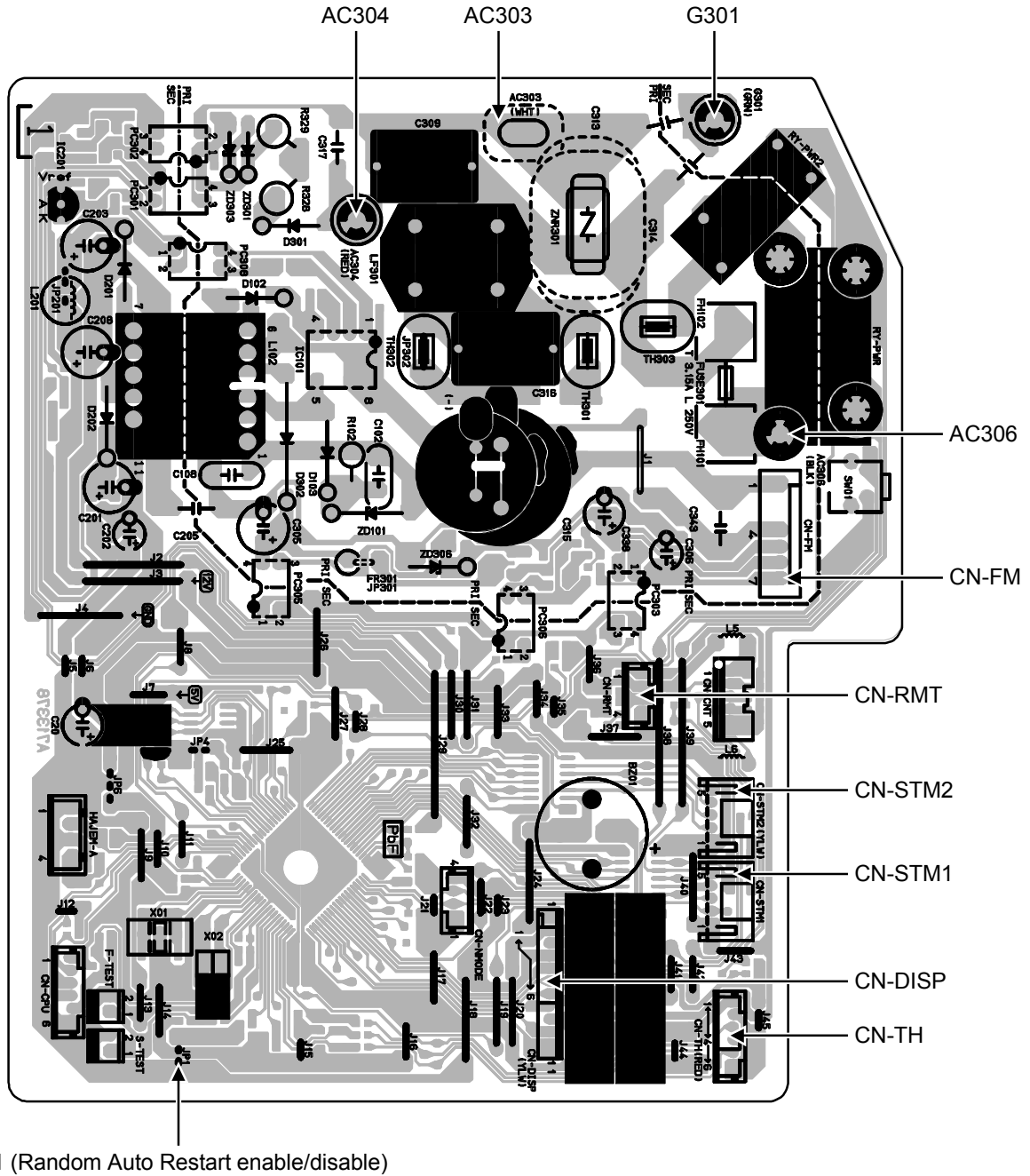

10.1.2 Indicator Printed Circuit Board

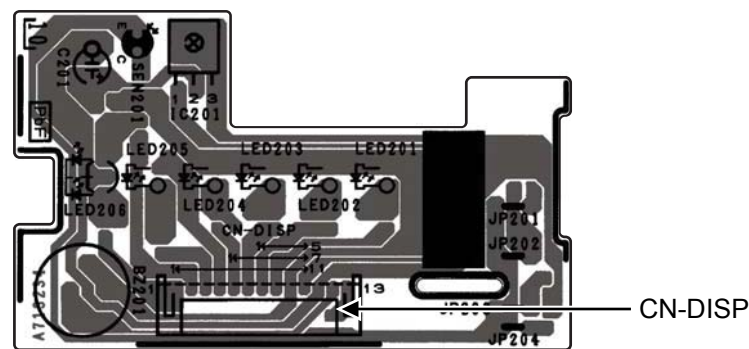

10.2 Outdoor Unit

10.2.1 Main Printed Circuit Board

10.2.1.1 CU-RE18RKE

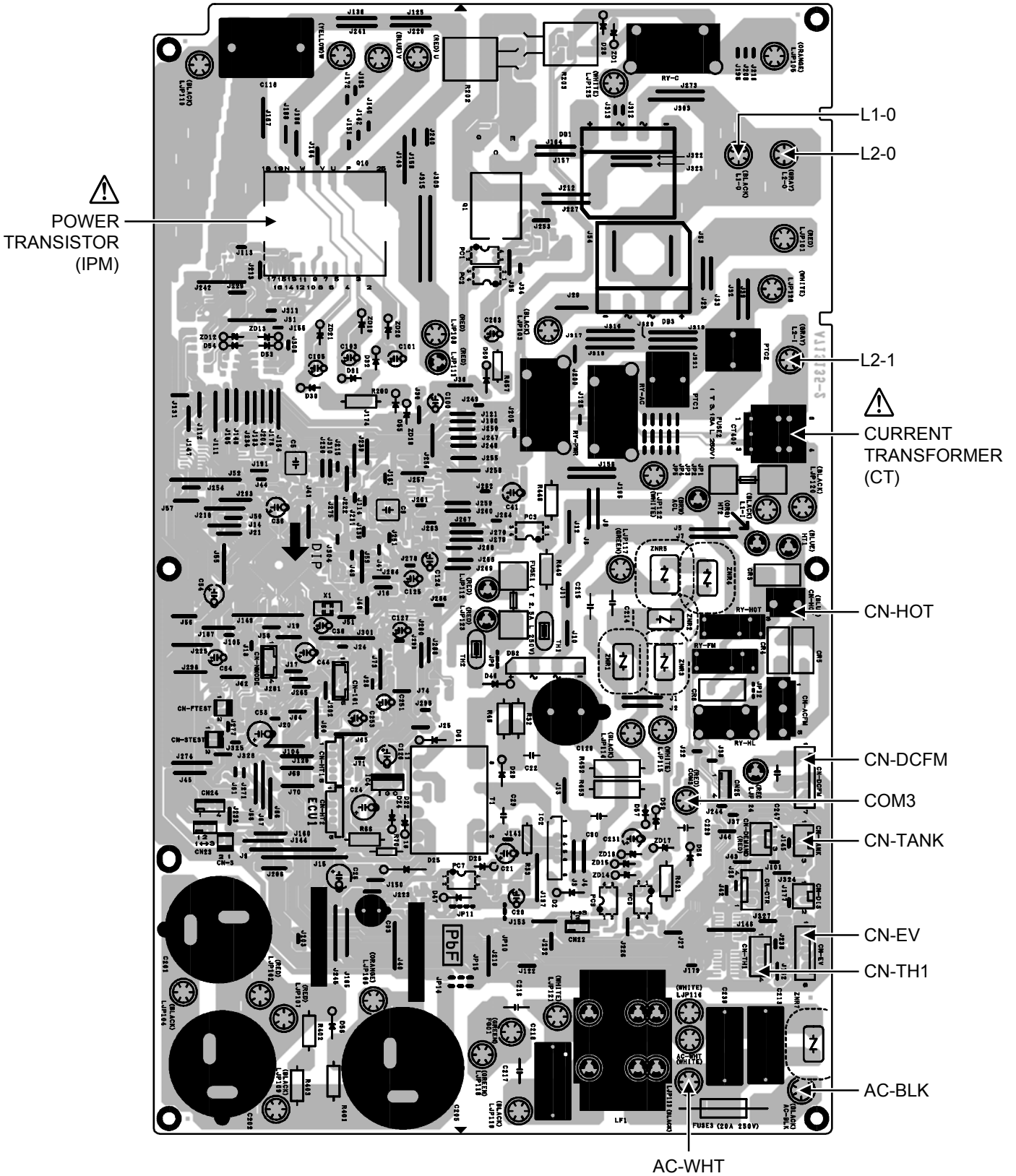

10.2.1.2 CU-RE24RKE

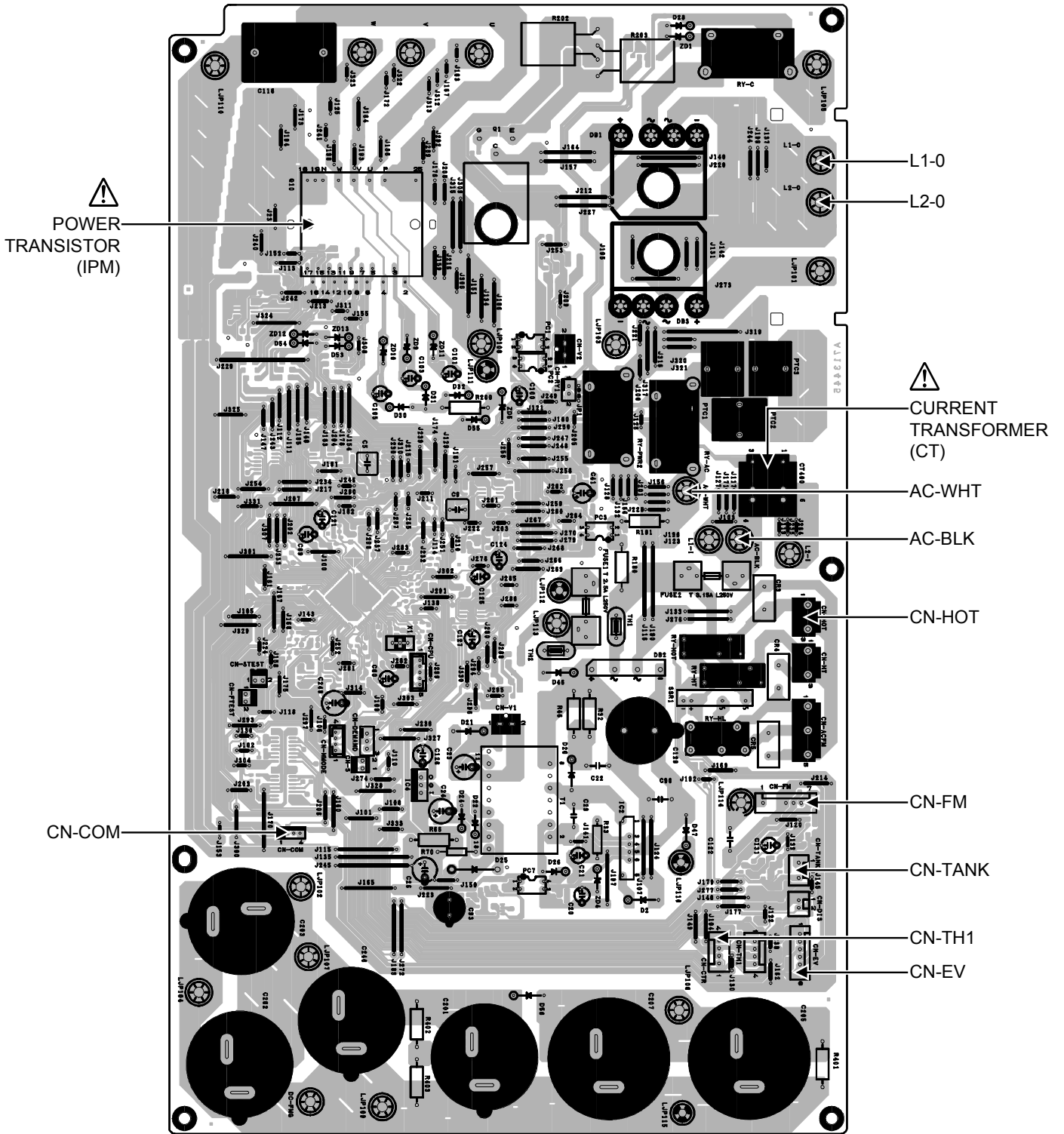

10.2.2 Noise Filter Printed Circuit Board

10.2.2.1 CU-RE24RKE

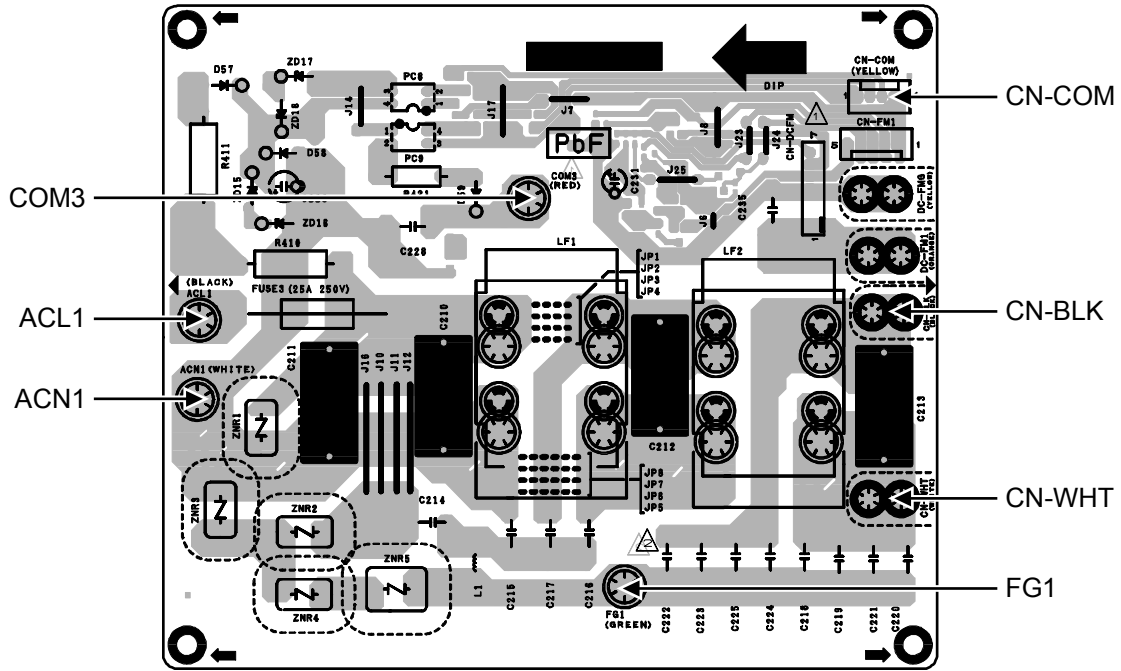

11. Installation Instruction

11.1 Select the Best Location

11.1.1 Indoor Unit

- Do not install the unit in excessive oil fume area such as kitchen, workshop and etc.
- There should not be any heat source or steam near the unit.
- There should not be any obstacles blocking the air circulation.
- A place where air circulation in the room is good.
- A place where drainage can be easily done.
- A place where noise prevention is taken into consideration.
- Do not install the unit near the door way.
- Ensure the spaces indicated by arrows from the wall, ceiling, fence or other obstacles.
- Recommended installation height for indoor unit shall be at least 2.5 m.

11.1.2 Outdoor Unit

- If an awning is built over the unit to prevent direct sunlight or rain, be careful that heat radiation from the condenser is not obstructed.
- There should not be any animal or plant which could be affected by hot air discharged.
- Keep the spaces indicated by arrows from wall, ceiling, fence or other obstacles.
- Do not place any obstacles which may cause a short circuit of the discharged air.
- If piping length is over the [piping length for additional gas], additional refrigerant should be added as shown in the table.

Model	Horse Power (HP)	Piping size		Std. Length (m)	Max. Elevation (m)	Min. Piping Length (m)	Max. Piping Length (m)	Additional Refrigerant (g/m)	Piping Length for add. gas (m)
		Gas	Liquid						
RE9***	1.0HP	9.52mm (3/8")	6.35mm (1/4")	5	15	3	15	20	7.5
RE12***	1.5HP				15	3	15	20	7.5
RE15**	1.75HP				15	3	15	20	7.5
RE18***	2.0HP				15	3	20	20	7.5
RE24**	2.5HP	15.88mm (5/8")			20	3	30	30	10

Example: For RE9***

If the unit is installed at 10 m distance, the quantity of additional refrigerant should be 50 g $(10 - 7.5) \text{ m} \times 20 \text{ g/m} = 50 \text{ g}$.

11.1.3 Indoor/Outdoor Unit Installation Diagram

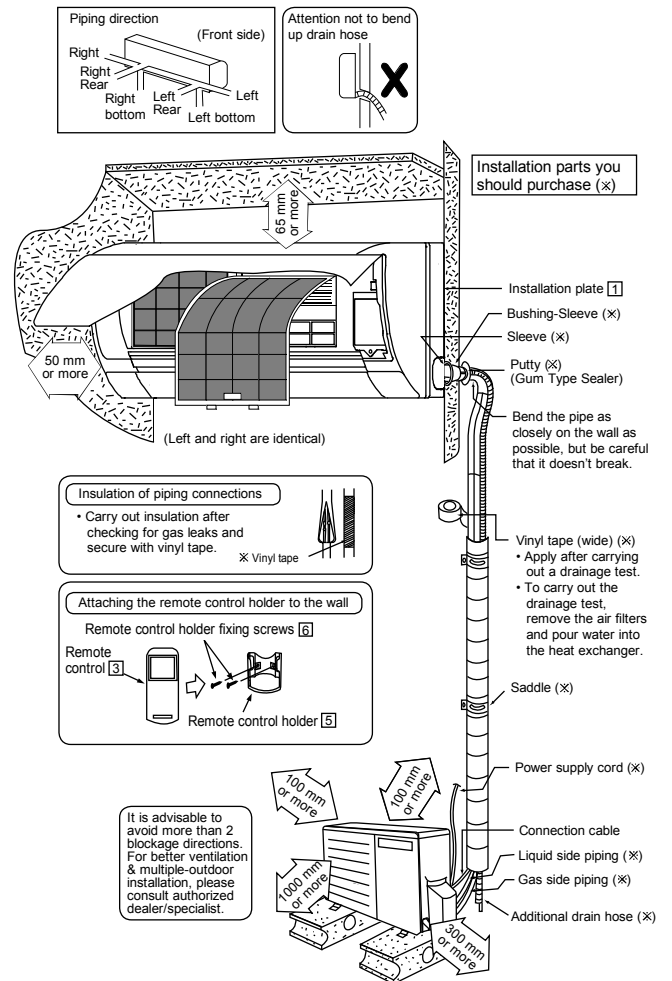

- This illustration is for explanation purposes only. The indoor unit will actually face a different way

11.2 Indoor Unit

11.2.1 How to Fix Installation Plate

The mounting wall shall be strong and solid enough to prevent it from the vibration.

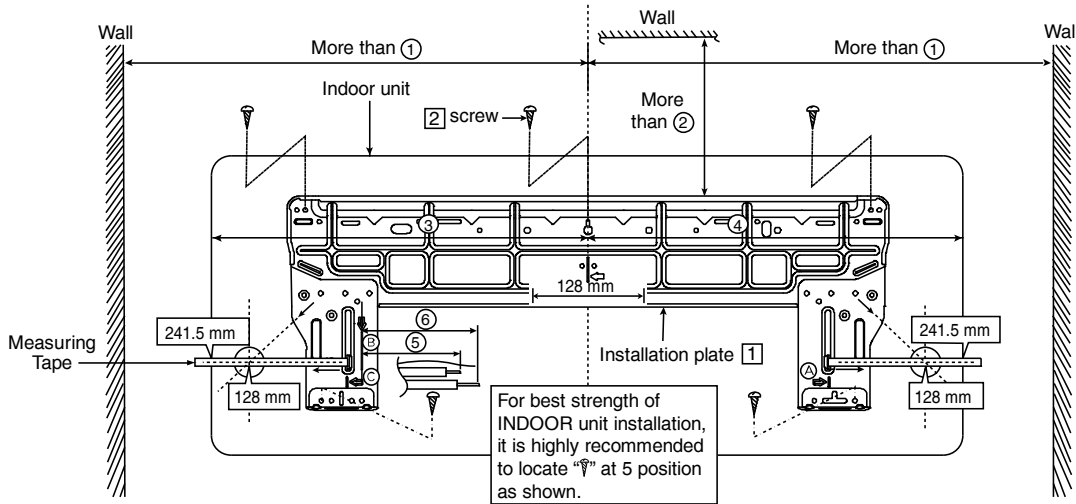

Model	Dimension					
	①	②	③	④	⑤	⑥
RE9***, RE12***, RE15***	490 mm	82 mm	439 mm	432 mm	43 mm	95 mm
RE18***, RE24***	590 mm	82 mm	539 mm	532 mm	169 mm	219 mm

The center of installation plate should be at more than ① at right and left of the wall.

The distance from installation plate edge to ceiling should more than ②.

From installation plate center to unit's left side is ③.

From installation plate center to unit's right side is ④.

⑤ : For left side piping, piping connection for liquid should be about ⑤ from this line.

⑥ : For left side piping, piping connection for gas should be about ⑥ from this line.

- Mount the installation plate on the wall with 5 screws or more (at least 5 screws).
(If mounting the unit on the concrete wall, consider using anchor bolts.)
 - Always mount the installation plate horizontally by aligning the marking-off line with the thread and using a level gauge.
- Drill the piping plate hole with $\varnothing 70$ mm hole-core drill.
 - Line according to the left and right side of the installation plate. The meeting point of the extended line is the center of the hole. Another method is by putting measuring tape at position as shown in the diagram above. The hole center is obtained by measuring the distance namely 128 mm for left and right hole respectively.
 - Drill the piping hole at either the right or the left and the hole should be slightly slanting to the outdoor side.

11.2.2 To Drill a Hole in the Wall and Install a Sleeve of Piping

- Insert the piping sleeve to the hole.
- Fix the bushing to the sleeve.
- Cut the sleeve until it extrudes about 15 mm from the wall.

⚠ CAUTION

❗ When the wall is hollow, please be sure to use the sleeve for tube assembly to prevent dangers caused by mice biting the connection cable.

- Finish by sealing the sleeve with putty or caulking compound at the final stage.

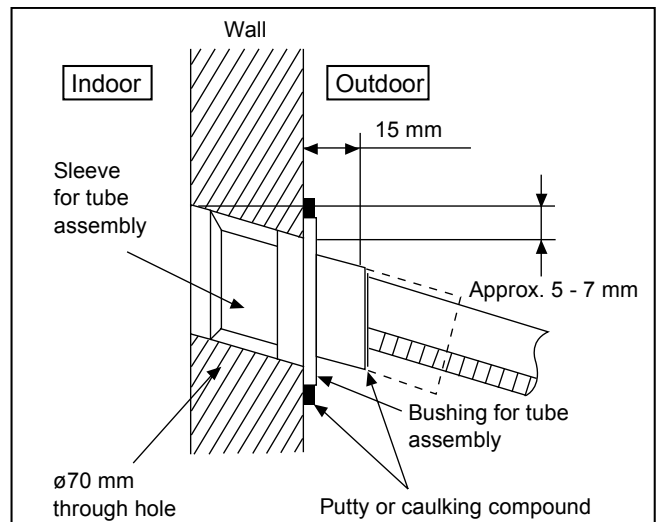

11.2.3 Indoor Unit Installation

- Do not turn over the unit without it's shock absorber during pull out the piping. It may cause intake grille damage.
- Use shock absorber during pull out the piping to protect the intake grille from damage.

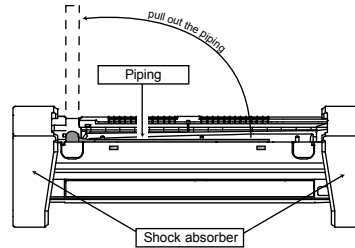
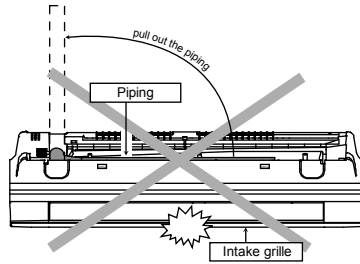

11.2.3.1 For the right rear piping

Step-1 Pull out the Indoor piping

Step-2 Install the Indoor Unit

Step-3 Secure the Indoor Unit

Step-4 Insert the connection cable

11.2.3.2 For the right and right bottom piping

Step-1 Pull out the Indoor piping

Step-2 Install the Indoor Unit

Step-3 Insert the connection cable

Step-4 Secure the Indoor Unit

11.2.3.3 For the embedded piping

Step-1 Replace the drain hose

Step-2 Bend the embedded piping

- Use a spring bender or equivalent to bend the piping so that the piping is not crushed.

Step-3 Pull the connection cable into Indoor Unit

- The inside and outside connection cable can be connected without removing the front grille.

Step-4 Cut and flare the embedded piping

- When determining the dimensions of the piping, slide the unit all the way to the left on the installation plate.
- Refer to the section "Cutting and flaring the piping".

Step-5 Install the Indoor Unit

Step-6 Connect the piping

- Please refer to "Connecting the piping" column in outdoor unit section. (Below steps are done after connecting the outdoor piping and gas-leakage confirmation.)

Step-7 Insulate and finish the piping

- Please refer to "Insulation of piping connection" column as mentioned in indoor/outdoor unit installation.

Step-8 Secure the Indoor Unit

Right Rear piping

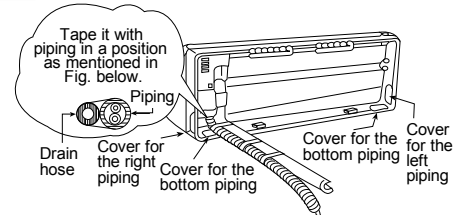

How to keep the cover

In case of the cover is cut, keep the cover at the rear of chassis as shown in the illustration for future reinstallation. (Left, right and 2 bottom covers for piping.)

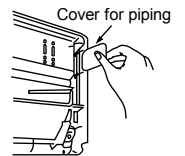

Right and Right Bottom piping

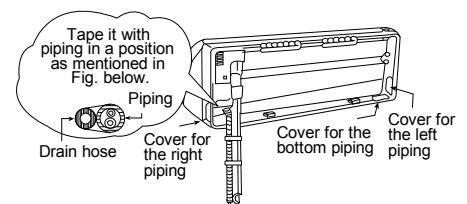

Install the indoor unit

Hook the indoor unit onto the upper portion of installation plate. (Engage the indoor unit with the upper edge of the installation plate). Ensure the hooks are properly seated on the installation plate by moving it in left and right.

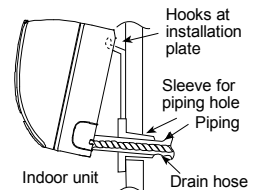

Secure the Indoor Unit

1. Press the lower left and right side of the unit against the installation plate until hooks engages with their slot (sound click).

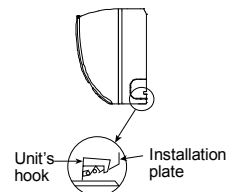

To take out the unit, push the [PUSH] marking at the bottom unit, and pull it slightly towards you to disengage the hooks from the unit.

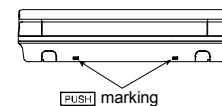

Insert the connection cable

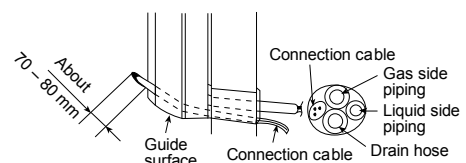

(This can be used for left rear piping and left bottom piping also.)

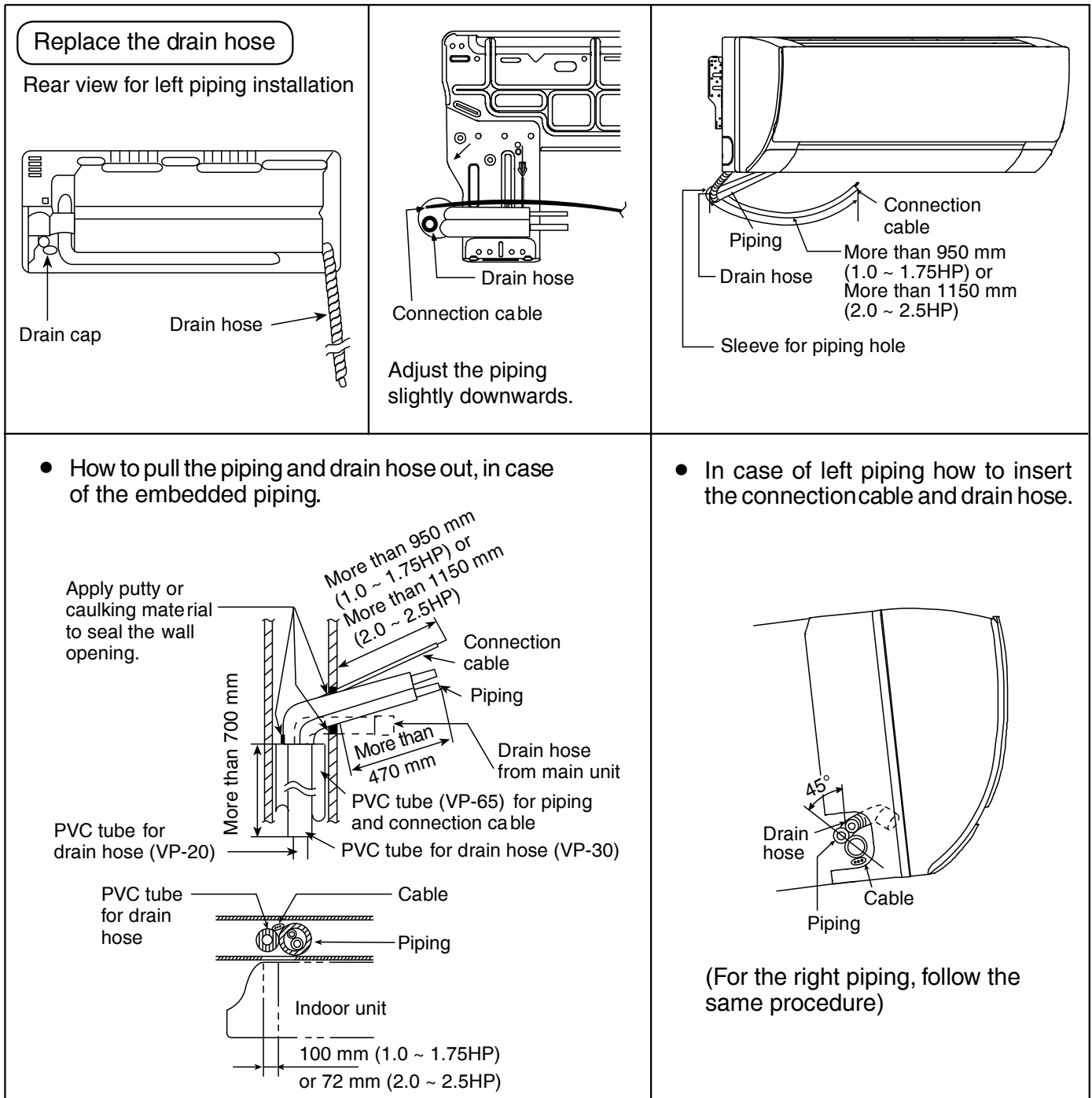

11.2.4 Connect the Cable to the Indoor Unit

- The inside and outside connection cable can be connected without removing the front grille.
- Connection cable** between indoor unit and outdoor unit shall be approved polychloroprene sheathed $4 \times 1.5 \text{ mm}^2$ flexible cord, type designation 60245 IEC 57 or heavier cord. Do not use joint connection cable. Replace the wire if the existing wire (from concealed wiring, or otherwise) is too short. Allowable connection cable length of each indoor unit shall be 30 m or less.
- Bind all the indoor and outdoor connection cable with tape and route the connection cable via the escapement.
- Remove the tapes and connect the connection cable between indoor unit and outdoor unit according to the diagram below.

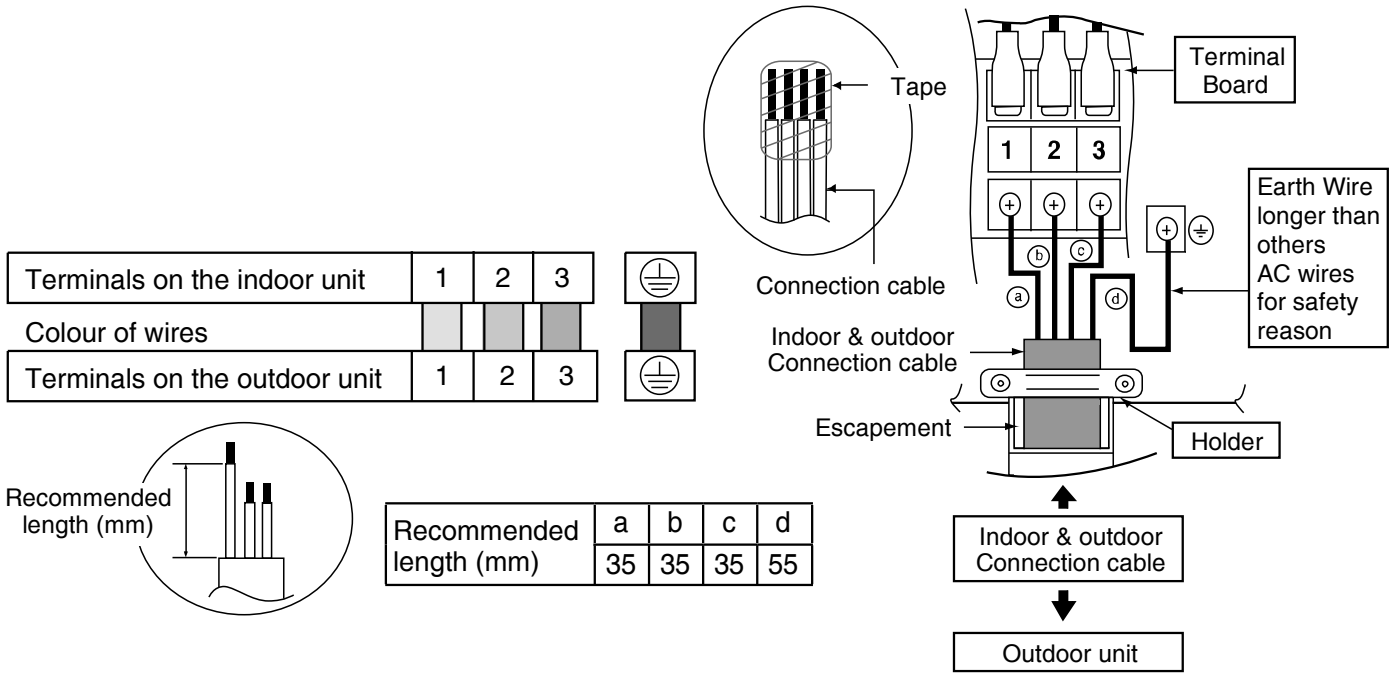

⚠ WARNING
 ⚡ This equipment must be properly earthed.

Note:

- Secure the connection cable onto the control board with the holder.
- Ensure the colour of wires of outdoor unit and the terminal Nos. are the same to the indoor's respectively.
- Earth wire shall be Yellow/Green (Y/G) in colour and longer than other AC wires for safety reason.

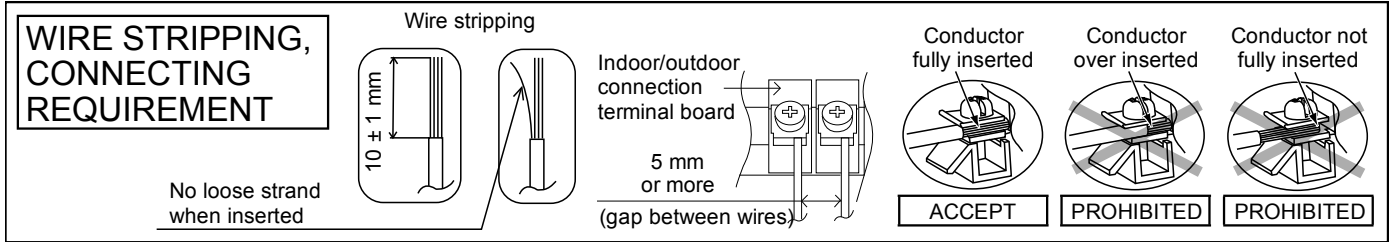

⚠ WARNING
 RISK OF FIRE
 JOINING OF WIRES
 MAY CAUSE
 OVERHEATING
 AND FIRE.

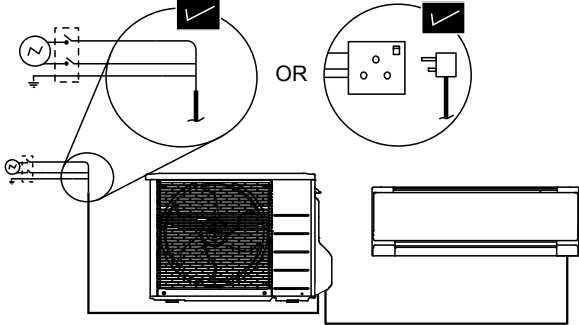
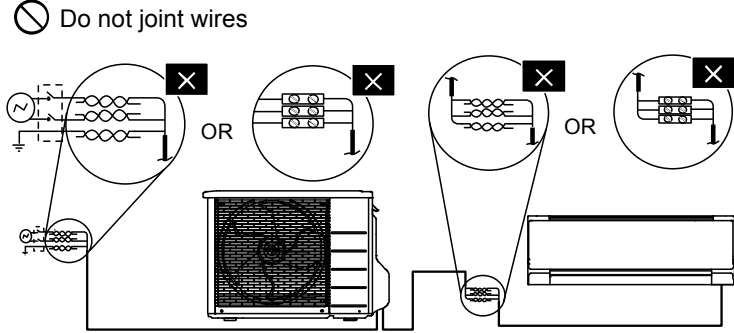

- ❗ Use complete wire without joining.
- ❗ Use approved socket and plug with earth pin.
- ❗ Wire connection in this area must follow to national wiring rules.

11.2.4.1 Cutting and flaring the piping

- 1 Please cut using pipe cutter and then remove the burrs.
- 2 Remove the burrs by using reamer. If burrs are not removed, gas leakage may be caused.
Turn the piping end down to avoid the metal powder entering the pipe.
- 3 Please make flare after inserting the flare nut onto the copper pipes.

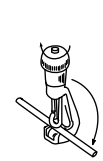

1. To cut

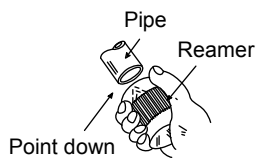

2. To remove burrs



3. To flare

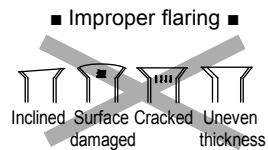
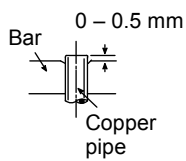

When properly flared, the internal surface of the flare will evenly shine and be of even thickness. Since the flare part comes into contact with the connections, carefully check the flare finish.

11.3 Outdoor Unit

11.3.1 Install the Outdoor Unit

- After selecting the best location, start installation according to Indoor/Outdoor Unit Installation Diagram.
 - Fix the unit on concrete or rigid frame firmly and horizontally by bolt nut ($\phi 10$ mm).
 - When installing at roof, please consider strong wind and earthquake.
Please fasten the installation stand firmly with bolt or nails.

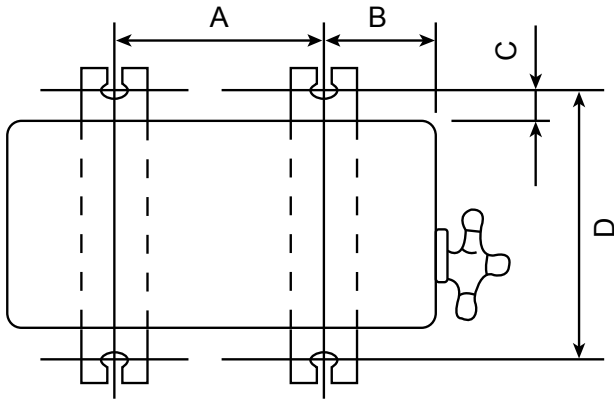

Model	A	B	C	D
RE9***	570 mm	105 mm	18.5 mm	320 mm
RE12*** RE15***	540 mm	160 mm	18.5 mm	330 mm
RE18*** RE24***	613 mm	130 mm	24 mm	360.5 mm

11.3.2 Connect the Piping

11.3.2.1 Connecting the Piping to Indoor

Please make flare after inserting flare nut (locate at joint portion, of tube assembly) onto the copper pipe.
(In case of using long piping)

Connect the piping

- Align the center of piping and sufficiently tighten the flare nut with fingers.
- Further tighten the flare nut with torque wrench in specified torque as stated in the table.

Do not overtighten, overtightening may cause gas leakage.

Piping size	Torque
6.35 mm (1/4")	[18 N•m (1.8 kgf•m)]
9.52 mm (3/8")	[42 N•m (4.3 kgf•m)]
12.7 mm (1/2")	[55 N•m (5.6 kgf•m)]
15.88 mm (5/8")	[65 N•m (6.6 kgf•m)]
19.05 mm (3/4")	[100 N•m (10.2 kgf•m)]

11.3.2.2 Connecting the Piping to Outdoor

Decide piping length and then cut by using pipe cutter.

Remove burrs from cut edge.

Make flare after inserting the flare nut (located at valve) onto the copper pipe.

Align center of piping to valves and then tighten with torque wrench to the specified torque as stated in the table.

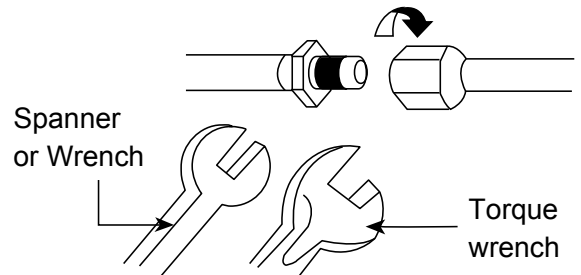

11.3.2.3 Connecting the Piping to Outdoor Multi

Decide piping length and then cut by using pipe cutter.

Remove burrs from cut edge.

Make flare after inserting the flare nut (locate at valve) onto the copper pipe.

Align center of piping to valve and then tighten with torque wrench to the specified torque as stated in the table.

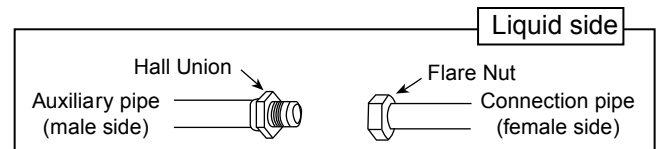

* For Gas side piping please refer table and diagram below

Outdoor Multi combination model		Pipe size (refer to diagram)	Gas side
CS-RE9***, CS-RE12***	CU-2E15***, CU-2E18***, CU-2RE15***, CU-2RE18***, CU-3E18***, CU-4E23***, CU-4E27***, CU-5E34***	①	① Hall Union Auxiliary pipe (male side) ——— Flare Nut Connection pipe (female side)
			② Hall Union Packing Flare Nut Auxiliary pipe (male side) ——— Connection pipe (female side) Pipe size reducer (CZ-MA1P)
CS-RE15***, CS-RE18***	CU-3E18***, CU-4E23***, CU-4E27***, CU-5E34***	② (CZ-MA1P)	③ Pipe size reducer Hall Union (CZ-MA3P) Flare Nut Packing Hall Union Auxiliary pipe (male side) (Indoor) ——— Connection pipe (female side) ——— Pipe size expander (CZ-MA2P) ——— Auxiliary pipe (male side) (Outdoor)
CS-RE24***	CU-4E27***, CU-5E34***	③ (CZ-MA2P) & (CZ-MA3P)	

11.3.3 Evacuation of the Equipment

WHEN INSTALLING AN AIR CONDITIONER, BE SURE TO EVACUATE THE AIR INSIDE THE INDOOR UNIT AND PIPES in the following procedure.

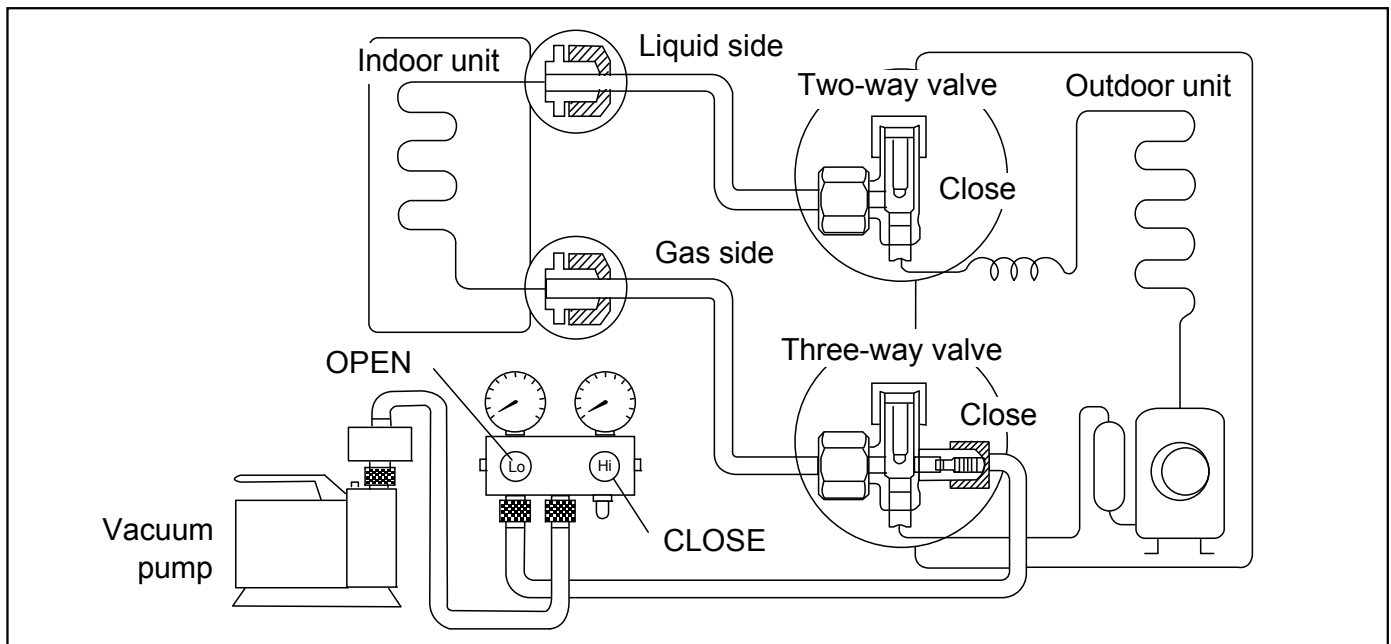

- 1 Connect a charging hose with a push pin to the Low side of a charging set and the service port of the 3-way valve.
 - Be sure to connect the end of the charging hose with the push pin to the service port.
 - 2 Connect the center hose of the charging set to a vacuum pump.
 - 3 Turn on the power switch of the vacuum pump and make sure that the needle in the gauge moves from 0 cmHg (0 MPa) to -76 cmHg (-0.1 MPa). Then evacuate the air approximately ten minutes.
 - 4 Close the Low side valve of the charging set and turn off the vacuum pump. Make sure that the needle in the gauge does not move after approximately five minutes.
- Note: BE SURE TO TAKE THIS PROCEDURE IN ORDER TO AVOID REFRIGERENT GAS LEAKAGE.
- 5 Disconnect the charging hose from the vacuum pump and from the service port of the 3-way valve.
 - 6 Tighten the service port caps of the 3-way valve at a torque of 18 N·m with a torque wrench.
 - 7 Remove the valve caps of both of the 2-way valve and 3-way valve. Position both of the valves to "OPEN" using a hexagonal wrench (4 mm).

- 8 Mount valve caps onto the 2-way valve and the 3-way valve.
 - Be sure to check for gas leakage. .

- If gauge needle does not move from 0 cmHg (0 MPa) to -76 cmHg (-0.1 MPa), in the step ③ above take the following measure:
 - If the leak stops when the piping connections are tightened further, continue working from step ③.
 - If the leak does not stop when the connections are retightened, repair location of leak.
 - Do not release refrigerant during piping work for installation and reinstallation.
 - Take care of the liquid refrigerant, it may cause frostbite.

11.3.4 Connect the Cable to the Outdoor Unit

1. Remove the control board cover from the unit by loosening the screw.
2. Cable connection to the power supply through Isolating Devices (Disconnecting means).
 - Connect approved type polychloroprene sheathed **power supply cord** 3 × 1.5 mm² (1.0 ~ 1.75HP), 3 × 2.5 mm² (2.0 ~ 2.5HP) type designation 60245 IEC 57 or heavier cord to the terminal board, and connect the others end of the cord to Isolating Devices (Disconnecting means).
 - Do not use joint power supply cord. Replace the wire if the existing wire (from concealed wiring, or otherwise) is too short.
 - In unavoidable case, joining of power supply cord between isolating devices and terminal board of air conditioner shall be done by using approved socket and plug with earth pin rated 15/16A (1.0 ~ 1.75HP) or 16A (2.0HP) or 20A (2.5HP). Wiring work to both socket and plug must follow to national wiring standard.
3. **Connection cable** between indoor unit and outdoor unit shall be approved polychloroprene sheathed 4 × 1.5 mm² flexible cord, type designation 60245 IEC 57 or heavier cord. Do not use joint connection cable. Replace the wire if the existing wire (from concealed wiring, or otherwise) is too short. Allowable connection cable length of each indoor unit shall be 30 mm or less.
4. Connect the power supply cord and connection cable between indoor unit and outdoor unit according to the diagram below.
5. Secure the power supply cord and connection cable onto the control board with the holder.
6. Attach the control board cover back to the original position with screw.
7. For wire stripping and connection requirement, refer to instruction 11.2.4 of indoor unit.

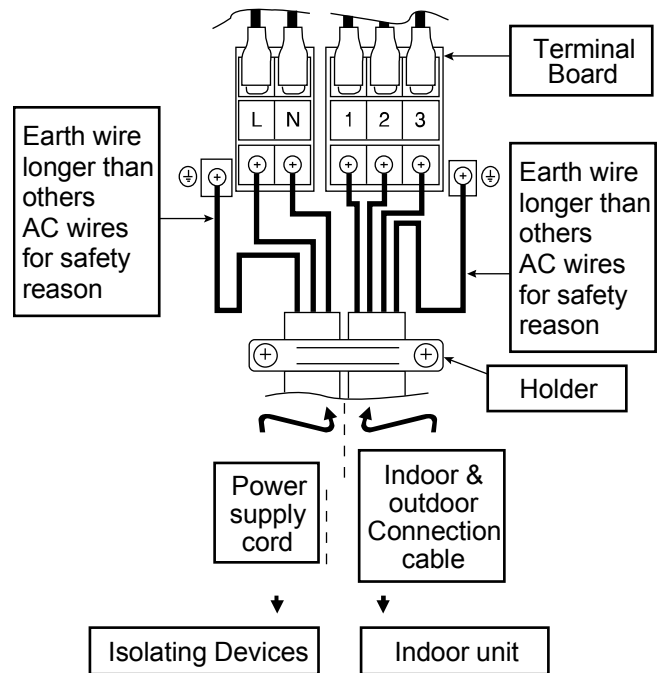

⚠ WARNING

⚡ This equipment must be properly earthed.

- Note: Isolating Devices (Disconnecting means) should have minimum 3.0 mm contact gap.
- Earth wire shall be Yellow/Green (Y/G) in colour and longer than other AC wires for safety reason.

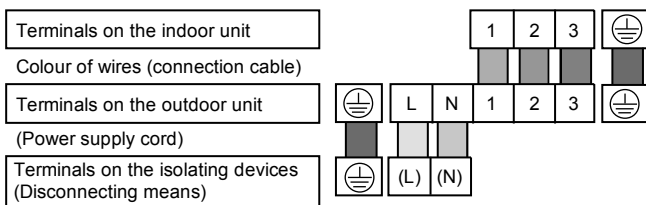

11.3.5 Piping Insulation

- 1 Please carry out insulation at pipe connection portion as mentioned in Indoor/Outdoor Unit Installation Diagram. Please wrap the insulated piping end to prevent water from going inside the piping.
- 2 If drain hose or connecting piping is in the room (where dew may form), please increase the insulation by using POLY-E FOAM with thickness 6 mm or above.

12. Operation and Control

12.1 Basic Function

Inverter control, which is equipped with a microcomputer to determine the most suitable operation mode as time passes, automatically adjusts output power for maximum comfort always. In order to achieve the suitable operation mode, the microcomputer maintains the set temperature by measuring the temperature of the environment and performing temperature shifting. The compressor at the outdoor unit is operating following the frequency instructed by the microcomputer at the indoor unit that judges the condition according to the internal setting temperature and intake air temperature.

12.1.1 Internal Setting Temperature

Once the operation starts, the remote control setting temperature will be taken as the base value for temperature shifting processes. These shifting processes depend on the air conditioner settings and the operation environment. The final shifted value will be used as the internal setting temperature and it is updated continuously whenever the electrical power is supplied to the unit.

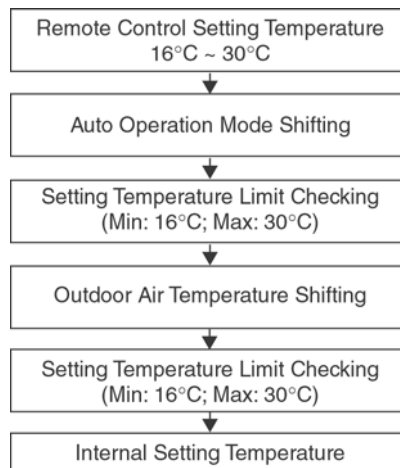

12.1.2 Cooling Operation

12.1.2.1 Thermostat control

- Compressor is OFF when Intake Air Temperature - Internal Setting Temperature < -1.5°C continue for 3 minutes.
- When compressor is OFF (Thermostat OFF) and AUTO FAN is set the fan will stop periodically.
- Compressor is ON after waiting for 3 minutes, if the Intake Air Temperature - Internal Setting Temperature > Compressor OFF point.

12.1.3 Soft Dry Operation

12.1.3.1 Thermostat control

- Compressor is OFF when Intake Air Temperature - Internal Setting Temperature < -2.0°C continued for 3 minutes.
- When compressor is OFF (Thermostat OFF) and AUTO FAN is set the fan will stop periodically.
- Compressor is ON after waiting for 3 minutes, if the Intake Air Temperature - Internal Setting Temperature > Compressor OFF point.

12.1.4 Heating Operation

12.1.4.1 Thermostat control

- Compressor is OFF when Intake Air Temperature - Internal Setting Temperature > +2.0°C continued for 3 minutes.
- Compressor is ON after waiting for 3 minutes, if the Intake Air Temperature - Internal Setting Temperature < Compressor OFF point.

12.1.5 Automatic Operation

- This mode can be set using remote control and the operation is decided by remote control setting temperature, remote control operation mode and indoor intake air temperature.
- During operation mode judgment, indoor fan motor (with speed of Lo-) is running for 30 seconds to detect the indoor intake air temperature.
- Every 10 minutes, the indoor temperature is judged.
- For the 1st judgment
 - 1 If indoor intake temperature - remote control setting temperature $\geq 2^{\circ}\text{C}$, COOL mode is decided.
 - 2 If $-2^{\circ}\text{C} \leq$ indoor intake temperature - remote control setting temperature $< 2^{\circ}\text{C}$, DRY mode is decided.
 - 3 If indoor intake temperature - remote control setting temperature $< -2^{\circ}\text{C}$, HEAT mode is decided.

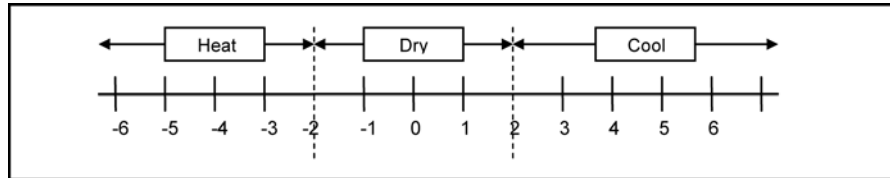

- For the 2nd judgment onwards
 - 1 If indoor intake temperature - remote control setting temperature $\geq 3^{\circ}\text{C}$, if previous operate in DRY mode, then continue in DRY mode. otherwise COOL mode is decided.
 - 2 If $-2^{\circ}\text{C} \leq$ indoor intake temperature - remote control setting temperature $< 3^{\circ}\text{C}$, maintain with previous mode.
 - 3 If indoor intake temperature - remote control setting temperature $< -2^{\circ}\text{C}$, HEAT mode is decided.

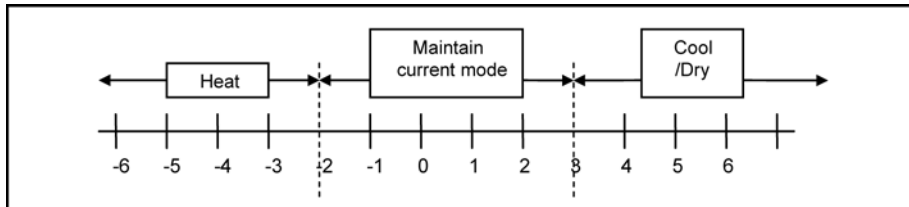

12.1.6 Indoor Fan Motor Operation

A. Basic Rotation Speed (rpm)

i. Manual Fan Speed

[Cooling, Dry]

- Fan motor's number of rotation is determined according to remote control setting.

Remote Control	○	○	○	○	○
Tab (rpm)	Hi	Me+	Me	Me-	Lo

[Heating]

- Fan motor's number of rotation is determined according to remote control setting.

Remote Control	○	○	○	○	○
Tab (rpm)	Shi	Me+	Me	Me-	Lo

ii. Auto Fan Speed

[Cooling, Dry]

- According to room temperature and setting temperature, indoor fan speed is determined automatically.
- When set temperature is not achieved, the indoor fan will operate according to pattern below.

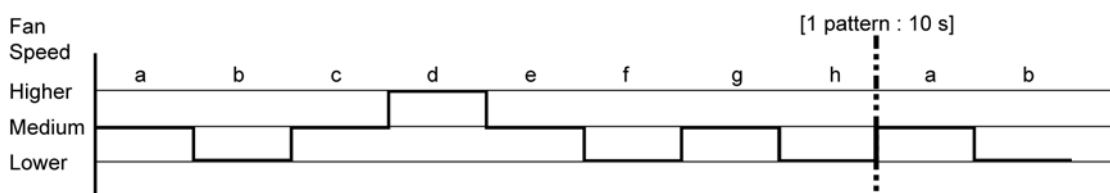

- When set temperature achieved, the fan speed will be fixed.

[Heating]

- According to indoor pipe temperature, automatic heating fan speed is determined as follows.

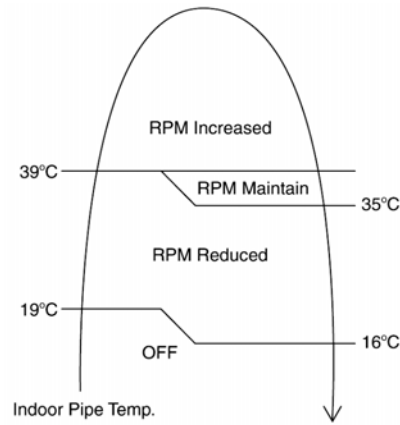

B. Feedback control

- Immediately after the fan motor started, feedback control is performed once every second.
- During fan motor on, if fan motor feedback ≥ 2550 rpm or < 50 rpm continue for 10 seconds, then fan motor error counter increase, fan motor is then stop and restart. If the fan motor counter becomes 7 times, then H19 - fan motor error is detected. Operation stops and cannot on back.

12.1.7 Outdoor Fan Motor Operation

Outdoor fan motor is operated with one fan speed only. It starts when compressor starts operation and it stops 30 seconds after compressor stops operation.

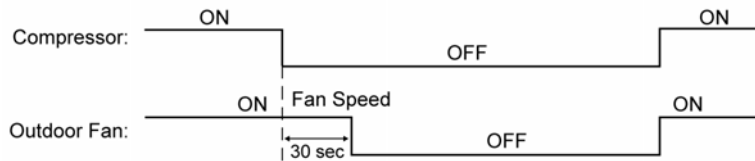

12.2 Airflow Direction

- 1 There are two types of airflow, vertical airflow (directed by horizontal vane) and horizontal airflow (directed by vertical vanes).
- 2 Control of airflow direction can be automatic (angles of direction is determined by operation mode, heat exchanger temperature and intake air temperature) and manual (angles of direction can be adjusted using remote control).

12.2.1 Vertical Airflow

Operation Mode			Vane Angle (°)				
			1	2	3	4	5
Cooling	Auto	Usual (Ventilation)	5 ~ 35				
		Control with dew	5 ~ 35				
	Manual	Usual (Ventilation)	5	12.5	20	27.5	35
		Control with dew	5	12.5	20	27.5	35
Dry	Auto	Usual	5 ~ 35				
		Control with dew	5 ~ 35				
	Manual	Usual	5	12.5	20	27.5	35
		Control with dew	5	12.5	20	27.5	35
Heating	Manual	Usual	5	17.5	30	42.5	55

- 1 Automatic vertical airflow direction can be set using remote control; the vane swings up and down within the angles as stated above. For heating mode operation, the angle of the vane depends on the indoor heat exchanger temperature as Figure 1 below. It does not swing during fan motor stop. When the air conditioner is stopped using remote control, the vane will shift to close position.

- 2 Manual vertical airflow direction can be set using remote control; the angles of the vane are as stated above and the positions of the vane are as Figure 2 below. When the air conditioner is stopped using remote control, the vane will shift to close position.

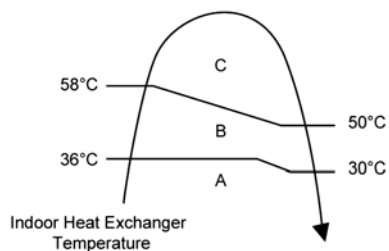

Figure 1

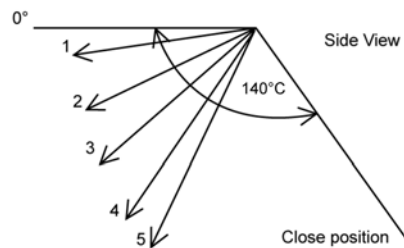

Figure 2

12.2.2 Horizontal Airflow

- 1 Automatic horizontal airflow direction can be set using remote control; the vane swings left and right within the angles as stated below. It does not swing during fan motor stop. For heating mode operation, the angle of the vane depends on the indoor heat exchanger temperature as Figure 1 below.

Operation Mode		Vane Angle (°)
Heating, with heat exchanger temperature	A	68 ~ 115
	B	90
Cooling and Soft Dry		68 ~ 115

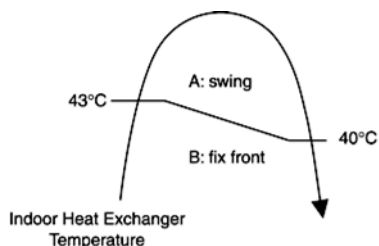

Figure 1

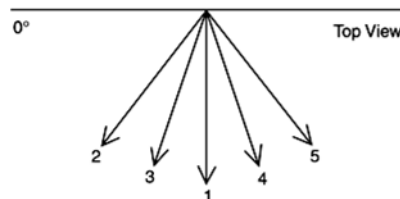

Figure 2

- 2 Manual horizontal airflow direction can be set using remote control; the angles of the vane are as stated below and the positions of the vane are as Figure 2 above.

Pattern	1	2	3	4	5
Airflow Direction Patterns at Remote Control					
Vane Angle (°)	90	70	80	100	110

12.3 Timer Control

- There are 2 sets of ON and OFF timer available to turn the unit ON or OFF at different preset time.
- If more than one timer had been set, the upcoming timer will be displayed and will activate in sequence.

12.3.1 ON Timer Control

- ON timer 1 and ON timer 2 can be set using remote control, the unit with timer set will start operate earlier than the setting time.
This is to provide a comfortable environment when reaching the set ON time.
- 60 minutes before the set time, indoor (at fan speed of Lo-) and outdoor fan motor start operate for 30 seconds to determine the indoor intake air temperature and outdoor air temperature in order to judge the operation starting time.
- From the above judgment, the decided operation will start operate earlier than the set time as shown below.

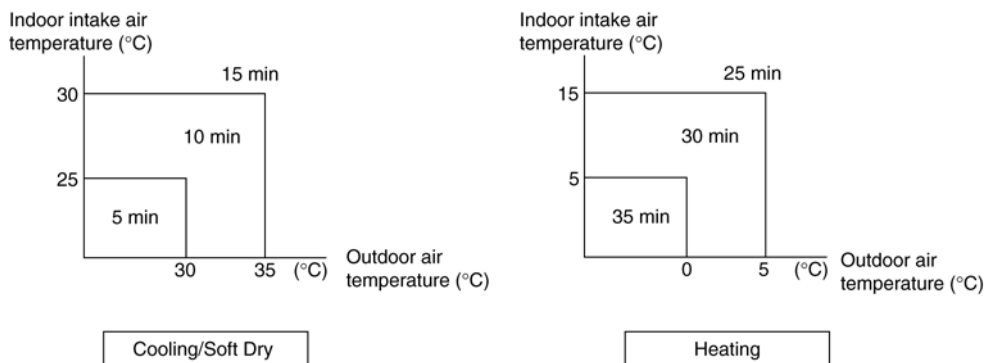

12.3.2 OFF Timer Control

OFF timer 1 and OFF timer 2 can be set using remote control, the unit with timer set will stop operate at set time.

12.4 Auto Restart Control

- 1 When the power supply is cut off during the operation of air conditioner, the compressor will re-operate within three to four minutes (there are 10 patterns between 2 minutes 58 seconds and 3 minutes 52 seconds to be selected randomly) after power supply resumes.
- 2 This type of control is not applicable during ON/OFF Timer setting.
- 3 This control can be omitted by short the circuit of JP1 at indoor unit printed circuit board.

12.5 Indication Panel

LED	POWER	TIMER	POWERFUL	QUIET
Color	Green	Orange	Orange	Orange
Light ON	Operation ON	Timer Setting ON	Powerful ON	Quiet ON
Light OFF	Operation OFF	Timer Setting OFF	Powerful OFF	Quiet OFF

- Note:
- If POWER LED is blinking, the possible operation of the unit are Hot Start, during Deice operation, operation mode judgment, or ON timer sampling.
 - If Timer LED is blinking, there is an abnormality operation occurs.

12.6 Quiet Operation (Cooling Mode/Cooling Area of Dry Mode)

A. Purpose

To provide quiet cooling operation compare to normal operation.

B. Control condition

- a. Quiet operation start condition
 - o When "POWERFUL/QUIET" button at remote control is pressed twice.
QUIET LED illuminates (low intensity).
- b. Quiet operation stop condition
 - 1 When one of the following conditions is satisfied, quiet operation stops:
 - a. POWERFUL/QUIET button is pressed again.
 - b. Stop by OFF/ON switch.
 - c. Timer "off" activates.
 - 2 When quiet operation is stopped, operation is shifted to normal operation with previous setting.
 - 3 When fan speed is changed, quiet operation is shifted to quiet operation of the new fan speed.
 - 4 When operation mode is changed, quiet operation is shifted to quiet operation of the new mode.
 - 5 During quiet operation, if timer "on" activates, quiet operation maintains.
 - 6 After off, when on back, quiet operation is not memorized.

C. Control contents

- 1 Fan speed is changed from normal setting to quiet setting of respective fan speed.
- 2 Fan speed for quiet operation is reduced from setting fan speed.

12.7 Quiet Operation (Heating)

A. Purpose

To provide quiet heating operation compare to normal operation.

B. Control condition

- a. Quiet operation start condition
 - o When "POWERFUL/QUIET" button at remote control is pressed.
QUIET LED illuminates.
- b. Quiet operation stop condition
 - 1 When one of the following conditions is satisfied, quiet operation stops:
 - a. POWERFUL/QUIET button is pressed again.
 - b. Stop by OFF/ON switch.
 - c. Timer "off" activates.
 - 2 When quiet operation is stopped, operation is shifted to normal operation with previous setting.
 - 3 When fan speed is changed, quiet operation is shifted to quiet operation of the new fan speed.
 - 4 When operation mode is changed, quiet operation is shifted to quiet operation of the new mode.
 - 5 During quiet operation, if timer "on" activates, quiet operation maintains.
 - 6 After off, when on back, quiet operation is not memorized.

C. Control contents

- a. Fan Speed manual
 - 1 Fan speed is changed from normal setting to quiet setting of respective fan speed.
 - 2 Fan speed for quiet operation is reduced from setting fan speed.
- b. Fan Speed Auto
 - 1 Indoor FM RPM depends on pipe temp sensor of indoor heat exchanger.

12.8 Powerful Mode Operation

- When the powerful mode is selected, the internal setting temperature will shift lower up to 2°C (for Cooling/Soft Dry) or higher up to 3.5°C (for Heating) than remote control setting temperature for 20 minutes to achieve the setting temperature quickly.

13. Protection Control

13.1 Protection Control For All Operations

13.1.1 Time Delay Safety Control

- The compressor will not start for three minutes after stop of operation.
- This control is not applicable if the power supply is cut off and on again or after 4-way valve deices condition.

13.1.2 Total Running Current Control

- 1 When the outdoor unit total running current (AC) exceeds X value, the frequency instructed for compressor operation will be decreased.
- 2 If the running current does not exceed X value for five seconds, the frequency instructed will be increased.
- 3 However, if total outdoor unit running current exceeds Y value, compressor will be stopped immediately for three minutes.

Operation Mode	RE18RKE		RE24RKE	
	X (A)	Y (A)	X (A)	Y (A)
Cooling / Soft Dry (A)	11.73	14.67	14.52	19.04
Cooling / Soft Dry (B)	8.82		12.31	
Cooling / Soft Dry (C)	8.82		12.31	
Heating	9.99		11.44	

- 4 The first 30 minutes of cooling operation, (A) will be applied.

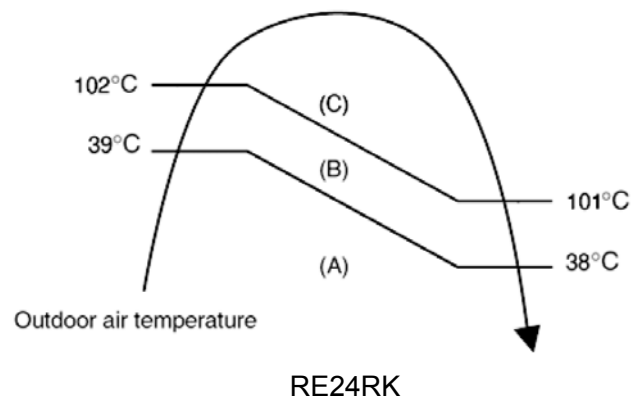
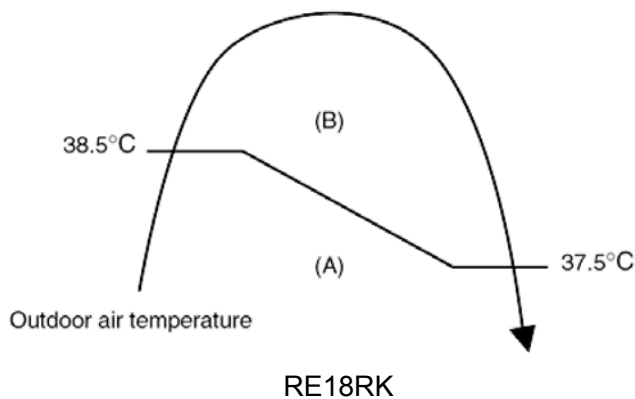

13.1.3 IPM (Power transistor) Prevention Control

- Overheating Prevention Control
 - When the IPM temperature rises to 120°C (RE18RK) and 110°C (RE24RK), compressor operation will stop immediately.
 - Compressor operation restarts after three minutes the temperature decreases to 110°C (RE18RK) and 95°C (RE24RK).
 - If this condition repeats continuously 4 times within 20 minutes, timer LED will be blinking ("F96" is indicated).
- DC Peak Current Control
 - When electric current to IPM exceeds set value of 30.0 ± 5.0 A, the compressor will stop operate. Then, operation will restart after three minutes.
 - If the set value is exceeded again more than 30 seconds after the compressor starts, the operation will restart after one minute.
 - If the set value is exceeded again within 30 seconds after the compressor starts, the operation will restart after one minute. If this condition repeats continuously for seven times, all indoor and outdoor relays will be cut off, timer LED will be blinking ("F99" is indicated).

13.1.4 Compressor Overheating Prevention Control

Instructed frequency for compressor operation will be regulated by compressor top temperature. The changes of frequency are as below figure.

If compressor discharge temperature exceeds 107°C (RE18RK) and 112°C (RE24RK), compressor will be stop, occurs 4 times per 20 minutes, timer LED will be blinking (“F97” is to be confirmed).

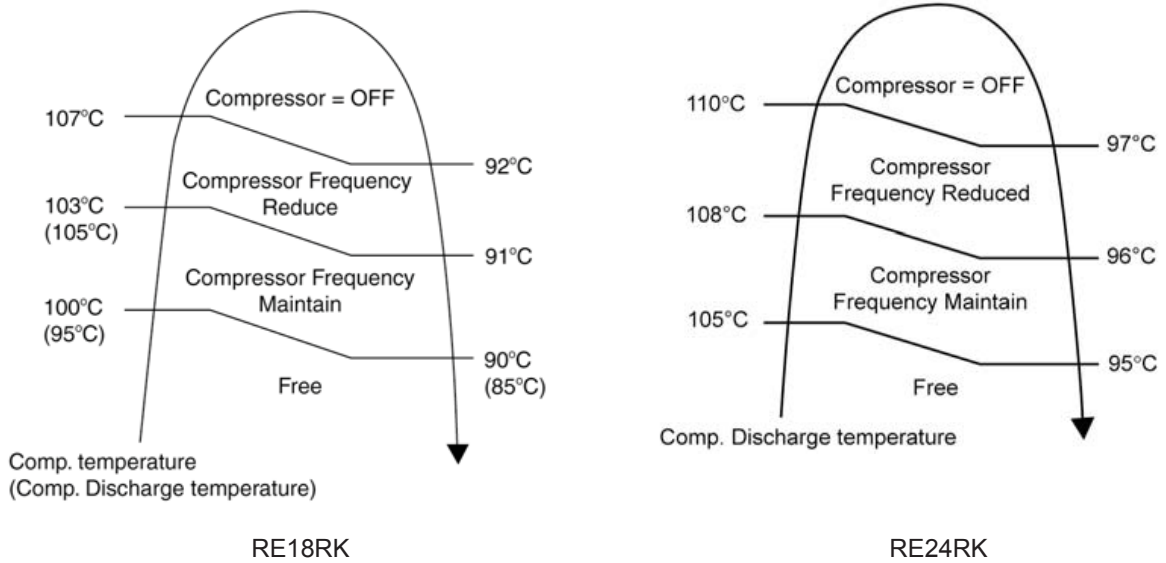

13.1.5 Low Pressure Prevention Control (Gas Leakage Detection)

- Control start conditions
 - For 5 minutes, the compressor continuously operates and outdoor total current is between 1.38A and 1.65A (RE18RK only).
 - For 5 minutes, the compressor continuously operates and outdoor total current is between 1.88A and 2.85A (Cooling), 2.85A and 3.57A (Heating) (RE24RK only).
 - During Cooling and Soft Dry operations:
Indoor suction temperature – indoor piping temperature is below 4°C.
 - During Heating operations:
Indoor piping temperature – indoor suction is under 5°C.
- Control contents
 - Compressor stops (and restart after 3 minutes).
 - If the conditions above happen 2 times within 20 minutes, the unit will:
 - Stop operation
 - Timer LED blinks and “F91” indicated.

13.1.6 Low Frequency Protection Control 1

- When the compressor operate at frequency lower than 24 Hz (RE18RK) and 20 Hz (RE24RK) continued for 20 minutes, the operation frequency will be changed to 23 Hz (RE18RK) and 21 Hz (RE24RK) for 2 minutes.

13.1.7 Low Frequency Protection Control 2

- When all below conditions comply, the compressor frequency will change to lower frequency.

Temperature, T, for:	Cooling / Soft Dry	Heating
Indoor intake air (°C)	T < 14 or T ≥ 30	T < 14 or T ≥ 28
Outdoor air (°C)	T < 13 or T ≥ 38	T < 4 or T ≥ 24
Indoor heat exchanger (°C)	T < 30	T ≥ 0

13.2 Protection Control For Cooling & Soft Dry Operation

13.2.1 Outdoor Air Temperature Control

The compressor operating frequency is regulated in accordance to the outdoor air temperature as shown in the diagram below.

This control will begin 1 minute after the compressor starts.

Compressor frequency will adjust base on Outdoor Air Temperature.

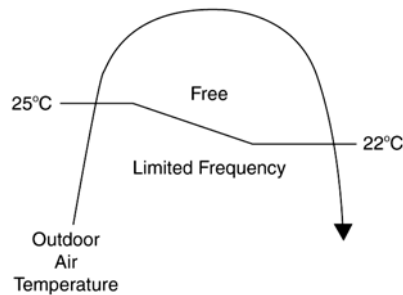

- The compressor will be stopped to avoid compressor overloading.

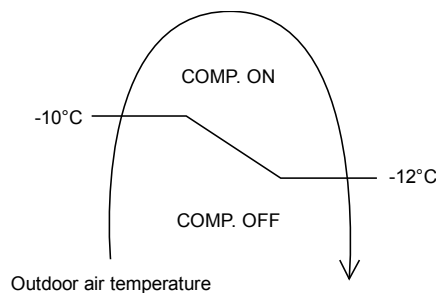

13.2.2 Cooling Overload Control

- Pipe temperature limitation / restriction (RE24RK only)
 - Detects the Outdoor pipe temperature and carry out below restriction/limitation (Limit the compressor Operation frequency)
 - The compressor stop if outdoor pipe temperature exceeds 63°C (RE18RK) and 65°C (RE24RK).
 - If the compressor stops 4 times in 20 minutes, Timer LED blinking (F95: outdoor high pressure rise protection)

13.2.3 Dew Prevention Control

- 1 To prevent dew formation at indoor unit discharge area.
- 2 This control activated if:
 - Outdoor air temperature and Indoor pipe temperature judgment by microcontroller if fulfilled.
 - When Cooling or Dry mode is operated more than 20 minutes or more.
- 3 This control stopped if:
 - Compressor stopped.
 - Remote control setting changed. (fan speed / temperature)
 - Outdoor air temperature and indoor intake temperature changed.
- 4 Fan speed will be adjusted accordingly in this control.

13.2.4 Freeze Prevention Control 1

- 1 When indoor heat exchanger temperature is lower than 0°C continuously for six minutes, compressor will stop operating.
- 2 Compressor will resume its operation three minutes after the indoor heat exchanger is higher than 5°C.
- 3 At the same time, indoor fan speed will be higher than during its normal operation.
- 4 If indoor heat exchanger temperature is higher than 5°C for five minutes, the fan speed will return to its normal operation.

13.2.5 Freeze Prevention Control 2

- 1 Control start conditions
 - During Cooling operation and soft dry operation
 - During thermo OFF condition, indoor intake temperature is less than 10°C or
 - Compressor stops for freeze prevention control
 - Either one of the conditions above occurs 5 times in 60 minutes.
- 2 Control contents
 - Operation stops.
 - Timer LED blinks and “H99” indicated.

13.2.6 Odor Cut Control

- To reduce the odor released from the unit.
 - Start Condition
 - AUTO FAN Speed is selected during COOL or DRY operation.
 - During freeze prevention control and timer preliminary operation, this control is not applicable.
 - Control content
 - Depends on compressor conditions:
 1. Compressor OFF → Compressor ON.
The indoor unit fan stops temporarily and then starts to blow at minimum airflow for 30 seconds.
 2. Compressor ON → Compressor OFF.
The indoor unit fan stops for 90 seconds and then blows at minimum airflow for 20 seconds.

13.3 Protection Control For Heating Operation

13.3.1 Intake Air Temperature Control

Compressor will operate at limited frequency if indoor intake air temperature is 30°C or above.

13.3.2 Outdoor Air Temperature Control

The maximum current value is regulated when the outdoor air temperature rises above 14°C in order to avoid compressor overloading.

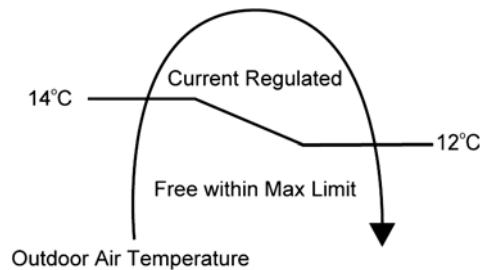

- The compressor will be stopped to avoid compressor overloading.

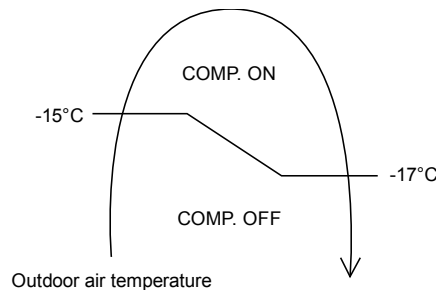

13.3.3 Overload Protection Control

- The compressor operating frequency is regulated in accordance to indoor heat exchanger temperature as shown in below figures.
- If the heat exchanger temperature exceeds 60°C, compressor will stop (RE18RK).

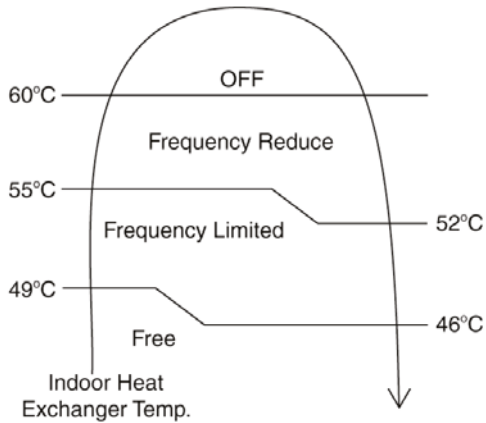

RE18RK

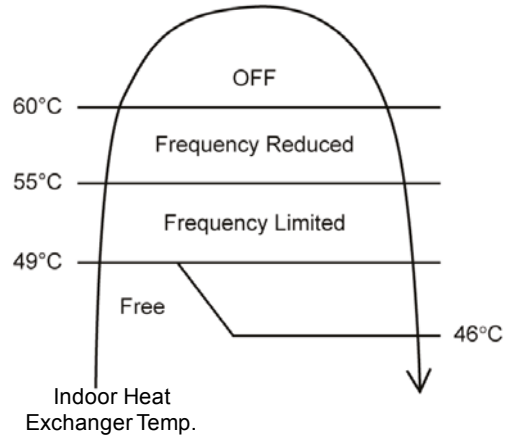

RE24RK

13.3.4 Cold Draught Prevention Control

When indoor pipe temperature is low, cold draught operation starts where indoor fan speed will be reduced.

13.3.5 Deice Operation

When outdoor pipe temperature and outdoor air temperature is low, deice operation start where indoor fan motor and outdoor fan motor stop and operation LED blinks.

14. Servicing Mode

14.1 Auto OFF/ON Button

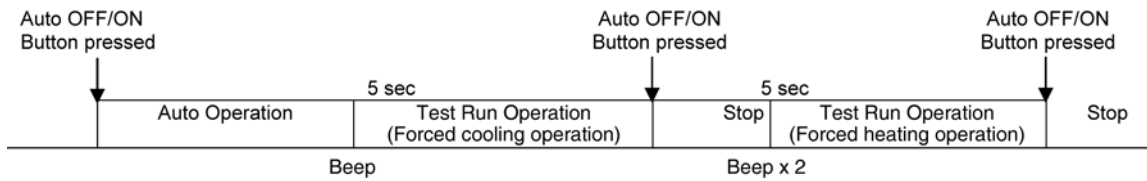

1 AUTO OPERATION MODE

The Auto Operation will be activated immediately once the Auto OFF/ON button is pressed. This operation can be used to operate air conditioner with limited function if remote control is misplaced or malfunction.

2 TEST RUN OPERATION (FOR PUMP DOWN/SERVICING PURPOSE)

The Test Run operation will be activated if the Auto OFF/ON button is pressed continuously for more than 5 seconds. A “beep” sound will occur at the fifth seconds, in order to identify the starting of Test Run operation (Forced cooling operation). Within 5 minutes after Forced cooling operation start, the Auto OFF/ON button is pressed for more than 5 seconds. A 2 “beep” sounds will occur at the fifth seconds, in order to identify the starting of Forced heating operation.

The Auto OFF/ON button may be used together with remote control to set / change the advance setting of air conditioner operation.

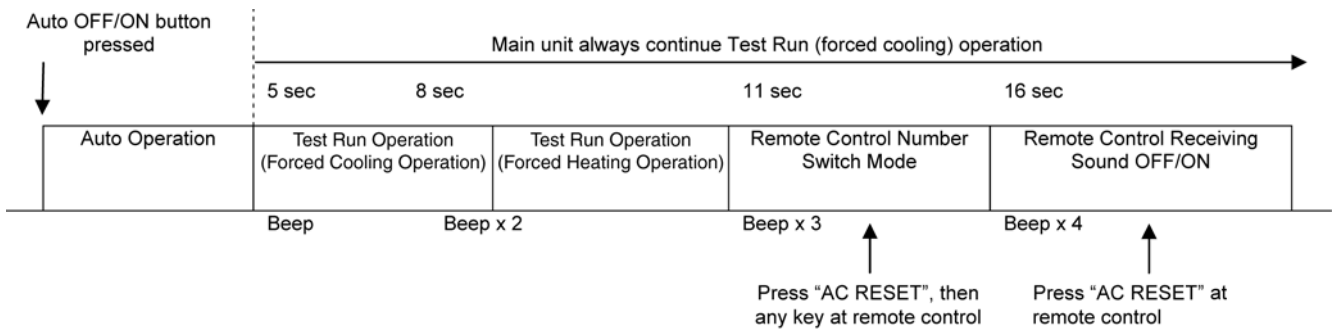

3 REMOTE CONTROL NUMBER SWITCH MODE

The Remote Control Number Switch Mode will be activated if the Auto OFF/ON button is pressed continuously for more than 11 seconds (3 “beep” sounds will occur at 11th seconds to identify the Remote Control Number Switch Mode is in standby condition) and press “AC RESET” button and then press any button at remote control to transmit and store the desired transmission code to the EEPROM.

There are 4 types of remote control transmission code could be selected and stored in EEPROM of indoor unit. The indoor unit will only operate when received signal with same transmission code from remote control. This could prevent signal interference when there are 2 or more indoor units installed nearby together. To change remote control transmission code, short or open jumpers at the remote control printed circuit board.

Remote Control Printed Circuit Board		
Jumper A (JA)	Jumper B (JB)	Remote Control No.
Short	Open	A (Default)
Open	Open	B
Short	Short	C
Open	Short	D

- During Remote Control Number Switch Mode, press any button at remote control to transmit and store the transmission code to the EEPROM.

4 REMOTE CONTROL RECEIVING SOUND OFF/ON MODE

The Remote Control Receiving Sound OFF/ON Mode will be activated if the Auto OFF/ON button is pressed continuously for more than 16 seconds (4 “beep” sounds will occur at 16th seconds to identify the Remote Control Receiving Sound Off/On Mode is in standby condition) and press “AC Reset” button at remote control.

Press “Auto OFF/ON button” to toggle remote control receiving sound.

- Short “beep”: Turn OFF remote control receiving sound.
- Long “beep”: Turn ON remote control receiving sound.

After Auto OFF/ON button is pressed, the 20 seconds counter for Remote Control Receiving Sound OFF/ON Mode is restarted.

14.2 Remote Control Button

14.2.1 SET BUTTON

- To check remote control transmission code and store the transmission code to EEPROM.
 - Press “SET” button for more than 10 seconds by using pointer.
 - Press “TIMER SET” button until a “beep” sound is heard as confirmation of transmission code change.

14.2.2 RESET (RC)

- To clear and restore the remote control setting to factory default
 - Press once to clear the memory.

14.2.3 RESET (AC)

- To restore the unit’s setting to factory default
 - Press once to restore the unit’s setting.

14.2.4 TIMER ▲

- To change indoor unit indicator’s LED intensity
 - Press continuously for 5 seconds.

14.2.5 TIMER ▼

- To change remote control display from Degree Celsius to Degree Fahrenheit.
 - Press continuously for 10 seconds.

15. Troubleshooting Guide

15.1 Refrigeration Cycle System

In order to diagnose malfunctions, make sure that there are no electrical problems before inspecting the refrigeration cycle. Such problems include insufficient insulation, problem with the power source, malfunction of a compressor and a fan. The normal outlet air temperature and pressure of the refrigeration cycle depends on various conditions, the standard values for them are shown in the table on the right.

Normal Pressure and Outlet Air Temperature (Standard)

	Gas pressure MPa (kg/cm ² G)	Outlet air temperature (°C)
Cooling Mode	0.9 ~ 1.2 (9 ~ 12)	12 ~ 16
Heating Mode	2.3 ~ 2.9 (23 ~ 29)	36 ~ 45

- ★ Condition:
- Indoor fan speed; High
 - Outdoor temperature 35°C at cooling mode and 7°C at heating mode.
 - Compressor operates at rated frequency

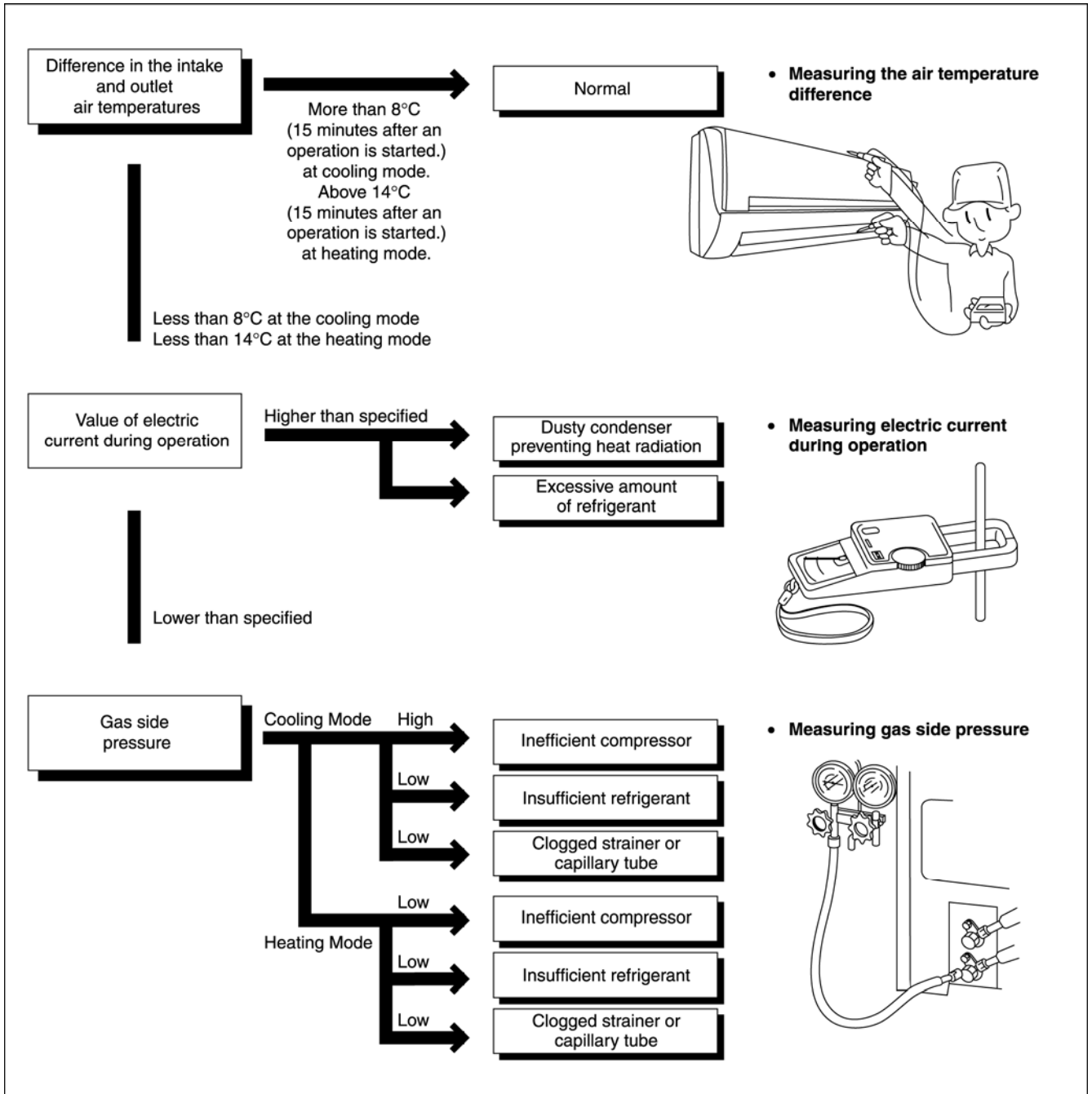

15.2 Relationship Between The Condition Of The Air Conditioner And Pressure And Electric Current

Condition of the air conditioner	Cooling Mode			Heating Mode		
	Low Pressure	High Pressure	Electric current during operation	Low Pressure	High Pressure	Electric current during operation
Insufficient refrigerant (gas leakage)	↘	↘	↘	↘	↘	↘
Clogged capillary tube or Strainer	↘	↘	↘	↗	↗	↗
Short circuit in the indoor unit	↘	↘	↘	↗	↗	↗
Heat radiation deficiency of the outdoor unit	↗	↗	↗	↘	↘	↘
Inefficient compression	↗	↘	↘	↗	↘	↘

- Carry out the measurements of pressure, electric current, and temperature fifteen minutes after an operation is started.

15.3 Breakdown Self Diagnosis Function

15.3.1 Self Diagnosis Function (Three Digits Alphanumeric Code)

- Once abnormality has occurred during operation, the unit will stop its operation, and Timer LEDs blink.
 - Although Timer LED goes off when power supply is turned off, if the unit is operated under a breakdown condition, the LED will light up again.
 - In operation after breakdown repair, the Timer LED will no more blink. The last error code (abnormality) will be stored in IC memory.
- 6 When the latest abnormality code on the main unit and code transmitted from the remote controller are matched, power LED will light up for 30 seconds and a beep sound (continuously for 4 seconds) will be heard. If no codes are matched, power LED will light up for 0.5 seconds and no sound will be heard.
 - 7 The breakdown diagnosis mode will be canceled unless pressing the CHECK button continuously for 5 seconds or operating the unit for 30 seconds.
 - 8 The same diagnosis can be repeated by turning power on again.

15.3.2 To Make a Diagnosis

- 1 Timer LED start to blink and the unit automatically stops the operation.
- 2 Press the CHECK button on the remote controller continuously for 5 seconds.
- 3 “- -” will be displayed on the remote controller display.
Note: Display only for “- -”. (No transmitting signal, no receiving sound and no Power LED blinking.)
- 4 Press the “TIMER” ▲ or ▼ button on the remote controller. The code “H00” (no abnormality) will be displayed and signal will be transmitted to the main unit.
- 5 Every press of the button (up or down) will increase abnormality numbers and transmit abnormality code signal to the main unit.
- 6 When the latest abnormality code on the main unit and code transmitted from the remote controller are matched, power LED will light up for 30 seconds and a beep sound (continuously for 4 seconds) will be heard. If no codes are matched, power LED will light up for 0.5 seconds and no sound will be heard.
- 7 The breakdown diagnosis mode will be canceled by pressing the CHECK button continuously for 5 seconds or without any operation the remote control for 30 seconds.
- 8 The LED will be off if the unit is turned off or the RESET button on the main unit is pressed.

15.3.3 To Display Memorized Error Code (Protective Operation) status:

- 1 Turn power on.
- 2 Press the CHECK button on the remote controller continuously for 5 seconds.
- 3 “- -” will be displayed on the remote controller display.
Note: Display only for “- -”. (No transmitting signal, no receiving sound and no Power LED blinking.)
- 4 Press the “TIMER” ▲ or ▼ button on the remote controller. The code “H00” (no abnormality) will be displayed and signal will be transmitted to the main unit. The power LED lights up. If no abnormality is stored in the memory, three beeps sound will be heard.
- 5 Every press of the button (up or down) will increase abnormality numbers and transmit abnormality code signal to the main unit.

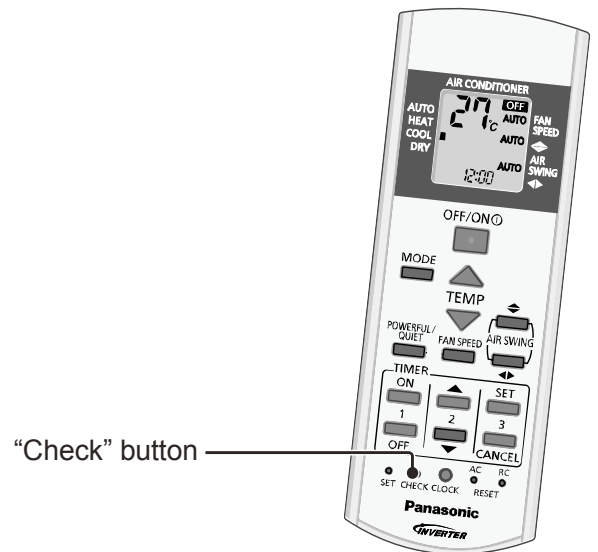

15.3.4 To Clear Memorized Error (Protective Operation) Status after Repair:

- 1 Turn power on (in standby condition).
- 2 Press the AUTO button for 5 seconds (A beep receiving sound) on the main unit to operate the unit at Forced Cooling Operation mode.
- 3 Press the CHECK button on the remote controller for about 1 second with a pointed object to transmit signal to main unit. A beep sound is heard from main unit and the data is cleared.

15.3.5 Temporary Operation (Depending On Breakdown Status)

- 1 Press the AUTO button (A beep receiving sound) on the main unit to operate the unit. (Remote control will become possible.)
- 2 The unit can temporarily be used until repaired.

Error Code	Operation	Temporary items
H23	Cooling	Emergency Operation with limited power
H27, H28	Cooling, Heating	
H26	Cooling, Heating	

15.4 Error Codes Table

Diagnosis display	Abnormality / Protection control	Abnormality Judgment	Protection Operation	Problem	Check location
H00	No memory of failure	—	Normal operation	—	—
H11	Indoor/outdoor abnormal communication	After operation for 1 minute	Indoor fan only operation can start by entering into force cooling operation	Indoor/outdoor communication not establish	<ul style="list-style-type: none"> Indoor/outdoor wire terminal Indoor/outdoor PCB Indoor/outdoor connection wire
H12	Indoor unit capacity unmatched	90s after power supply	—	Total indoor capability more than maximum limit or less than minimum limit, or number of indoor unit less than two	<ul style="list-style-type: none"> Indoor/outdoor connection wire Indoor/outdoor PCB Specification and combination table in catalogue
H14	Indoor intake air temperature sensor abnormality	Continuous for 5s	—	Indoor intake air temperature sensor open or short circuit	<ul style="list-style-type: none"> Indoor intake air temperature sensor lead wire and connector
H15	Compressor temperature sensor abnormality	Continuous for 5s	—	Compressor temperature sensor open or short circuit	<ul style="list-style-type: none"> Compressor temperature sensor lead wire and connector
H16	Outdoor current transformer (CT) abnormality	—	—	Current transformer faulty or compressor faulty	<ul style="list-style-type: none"> Outdoor PCB faulty or compressor faulty
H19	Indoor fan motor mechanism lock	Continuous happen for 7 times	—	Indoor fan motor lock or feedback abnormal	<ul style="list-style-type: none"> Fan motor lead wire and connector Fan motor lock or block
H23	Indoor heat exchanger temperature sensor abnormality	Continuous for 5s	—	Indoor heat exchanger temperature sensor open or short circuit	<ul style="list-style-type: none"> Indoor heat exchanger temperature sensor lead wire and connector
H24	Indoor heat exchanger temperature sensor 2 abnormality	Continuous for 5s	—	Indoor heat exchanger temperature sensor 2 open or short circuit	<ul style="list-style-type: none"> Indoor heat exchanger temperature sensor 2 lead wire and connector
H25	Indoor ion device abnormality	Port is ON for 10s during ion device off	—	—	<ul style="list-style-type: none"> ion device PCB
H27	Outdoor air temperature sensor abnormality	Continuous for 5s	—	Outdoor air temperature sensor open or short circuit	<ul style="list-style-type: none"> Outdoor air temperature sensor lead wire and connector
H28	Outdoor heat exchanger temperature sensor 1 abnormality	Continuous for 5s	—	Outdoor heat exchanger temperature sensor 1 open or short circuit	<ul style="list-style-type: none"> Outdoor heat exchanger temperature sensor 1 lead wire and connector
H30	Outdoor discharge pipe temperature sensor abnormality	Continuous for 5s	—	Outdoor discharge pipe temperature sensor open or short circuit	<ul style="list-style-type: none"> Outdoor discharge pipe temperature sensor lead wire and connector
H32	Outdoor heat exchanger temperature sensor 2 abnormality	Continuous for 5s	—	Outdoor heat exchanger temperature sensor 2 open or short circuit	<ul style="list-style-type: none"> Outdoor heat exchanger temperature sensor 2 lead wire and connector
H33	Indoor / outdoor misconnection abnormality	—	—	Indoor and outdoor rated voltage different	<ul style="list-style-type: none"> Indoor and outdoor units check
H34	Outdoor heat sink temperature sensor abnormality	Continuous for 2s	—	Outdoor heat sink temperature sensor open or short circuit	<ul style="list-style-type: none"> Outdoor heat sink sensor
H36	Outdoor gas pipe temperature sensor abnormality	Continuous for 5s	Heating protection operation only	Outdoor gas pipe temperature sensor open or short circuit	<ul style="list-style-type: none"> Outdoor gas pipe temperature sensor lead wire and connector
H37	Outdoor liquid pipe temperature sensor abnormality	Continuous for 5s	Cooling protection operation only	Outdoor liquid pipe temperature sensor open or short circuit	<ul style="list-style-type: none"> Outdoor liquid pipe temperature sensor lead wire and connector
H38	Indoor/Outdoor mismatch (brand code)	—	—	Brand code not match	<ul style="list-style-type: none"> Check indoor unit and outdoor unit
H39	Abnormal indoor operating unit or standby units	3 times happen within 40 minutes	—	Wrong wiring and connecting pipe, expansion valve abnormality, indoor heat exchanger sensor open circuit	<ul style="list-style-type: none"> Check indoor/outdoor connection wire and connection pipe Indoor heat exchanger sensor lead wire and connector Expansion valve and lead wire and connector

Diagnosis display	Abnormality / Protection control	Abnormality Judgment	Protection Operation	Problem	Check location
H41	Abnormal wiring or piping connection	—	—	Wrong wiring and connecting pipe, expansion valve abnormality	<ul style="list-style-type: none"> • Check indoor/outdoor connection wire and connection pipe • Expansion valve and lead wire and connector
H59	ECONAVI sensor abnormality	Continuous for 25s	—	ECONAVI sensor open or short circuit	<ul style="list-style-type: none"> • ECONAVI sensor (defective or disconnected) • ECONAVI PCB
H64	Outdoor high pressure sensor abnormality	Continuous for 1 minutes	—	High pressure sensor open circuit during compressor stop	<ul style="list-style-type: none"> • High pressure sensor • Lead wire and connector
H70	Light sensor abnormality	Continuous for 24 hours, 15days	—	Light sensor open or short circuit	<ul style="list-style-type: none"> • Light sensor (defective or disconnected)
H97	Outdoor fan motor mechanism lock	2 times happen within 30 minutes	—	Outdoor fan motor lock or feedback abnormal	<ul style="list-style-type: none"> • Outdoor fan motor lead wire and connector • Fan motor lock or block
H98	Indoor high pressure protection	—	—	Indoor high pressure protection (Heating)	<ul style="list-style-type: none"> • Check indoor heat exchanger • Air filter dirty • Air circulation short circuit
H99	Indoor operating unit freeze protection	—	—	Indoor freeze protection (Cooling)	<ul style="list-style-type: none"> • Check indoor heat exchanger • Air filter dirty • Air circulation short circuit
F11	4-way valve switching abnormality	4 times happen within 30 minutes	—	4-way valve switching abnormal	<ul style="list-style-type: none"> • 4-way valve • Lead wire and connector
F17	Indoor standby units freezing abnormality	3 times happen within 40 minutes	—	Wrong wiring and connecting pipe, expansion valve leakage, indoor heat exchanger sensor open circuit	<ul style="list-style-type: none"> • Check indoor/outdoor connection wire and pipe • Indoor heat exchanger sensor lead wire and connector • Expansion valve lead wire and connector
F90	Power factor correction (PFC) circuit protection	4 times happen within 10 minutes	—	Power factor correction circuit abnormal	<ul style="list-style-type: none"> • Outdoor PCB faulty
F91	Refrigeration cycle abnormality	2 times happen within 20 minutes	—	Refrigeration cycle abnormal	<ul style="list-style-type: none"> • Insufficient refrigerant or valve close
F93	Compressor abnormal revolution	4 times happen within 20 minutes	—	Compressor abnormal revolution	<ul style="list-style-type: none"> • Power transistor module faulty or compressor lock
F94	Compressor discharge overshoot protection	4 times happen within 30 minutes	—	Compressor discharge pressure overshoot	<ul style="list-style-type: none"> • Check refrigeration system
F95	Outdoor cooling high pressure protection	4 times happen within 20 minutes	—	Cooling high pressure protection	<ul style="list-style-type: none"> • Check refrigeration system • Outdoor air circuit
F96	Power transistor module overheating protection	4 times happen within 30 minutes	—	Power transistor module overheat	<ul style="list-style-type: none"> • PCB faulty • Outdoor air circuit (fan motor)
F97	Compressor overheating protection	3 times happen within 30 minutes	—	Compressor overheat	<ul style="list-style-type: none"> • Insufficient refrigerant
F98	Total running current protection	3 times happen within 20 minutes	—	Total current protection	<ul style="list-style-type: none"> • Check refrigeration system • Power source or compressor lock
F99	Outdoor direct current (DC) peak detection	Continuous happen for 7 times	—	Power transistor module current protection	<ul style="list-style-type: none"> • Power transistor module faulty or compressor lock

15.5 Self-diagnosis Method

15.5.1 H11 (Indoor/Outdoor Abnormal Communication)

Malfunction Decision Conditions

- During startup and operation of cooling and heating, the data received from outdoor unit in indoor unit signal transmission is checked whether it is normal.

Malfunction Caused

- Faulty indoor unit PCB.
- Faulty outdoor unit PCB.
- Indoor unit-outdoor unit signal transmission error due to wiring error.
- Indoor unit-outdoor unit signal transmission error due to breaking of wire in the connection wires between the indoor and outdoor units.

Troubleshooting

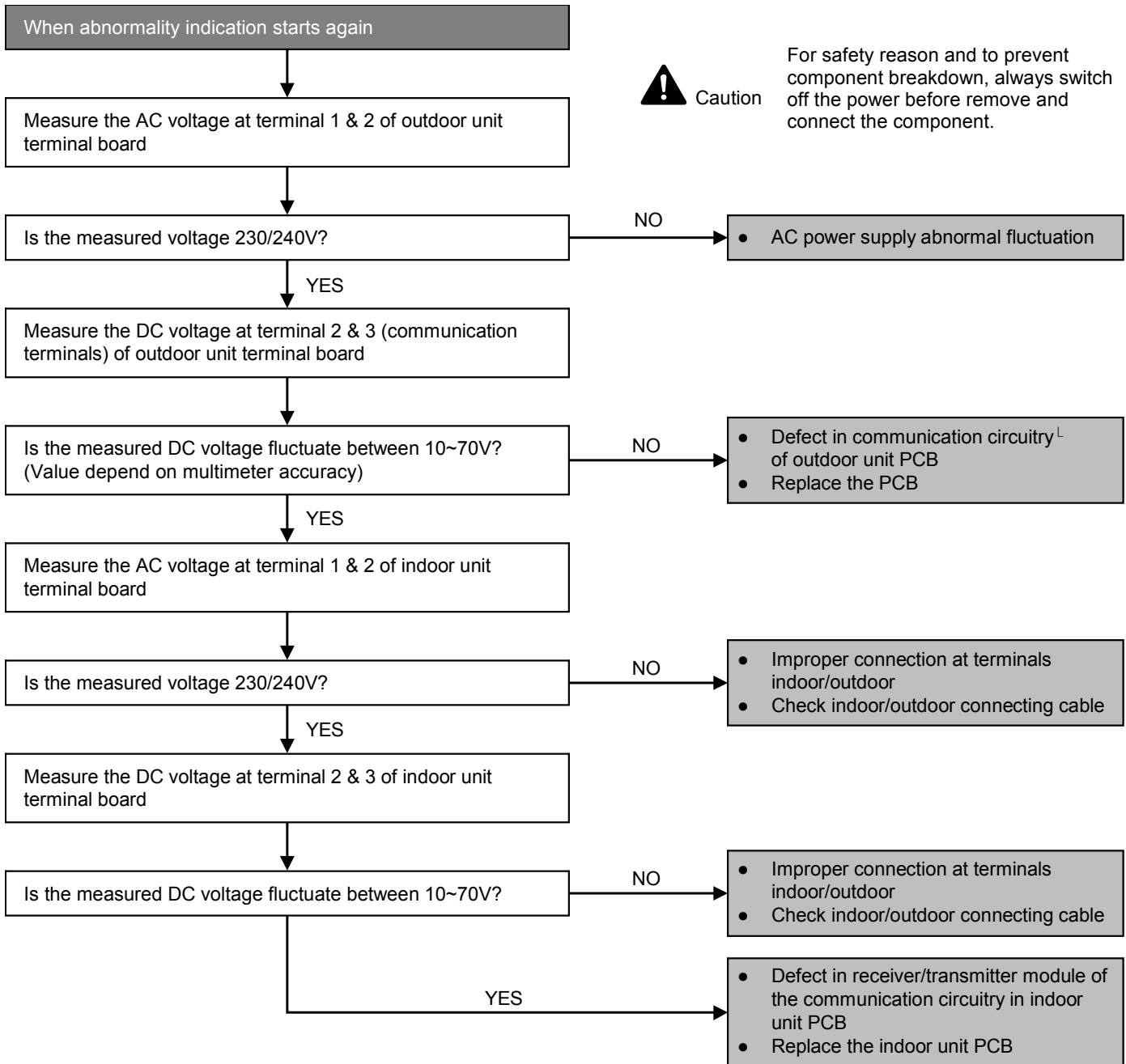

15.5.2 H12 (Indoor/Outdoor Capacity Rank Mismatched)

Malfunction Decision Conditions

- During startup, error code appears when different types of indoor and outdoor units are interconnected.

Malfunction Caused

- Wrong models interconnected.
- Wrong indoor unit or outdoor unit PCBs mounted.
- Indoor unit or outdoor unit PCBs defective.
- Indoor-outdoor unit signal transmission error due to wrong wiring.
- Indoor-outdoor unit signal transmission error due to breaking of wire 3 in the connection wires between the indoor and outdoor units.

Troubleshooting

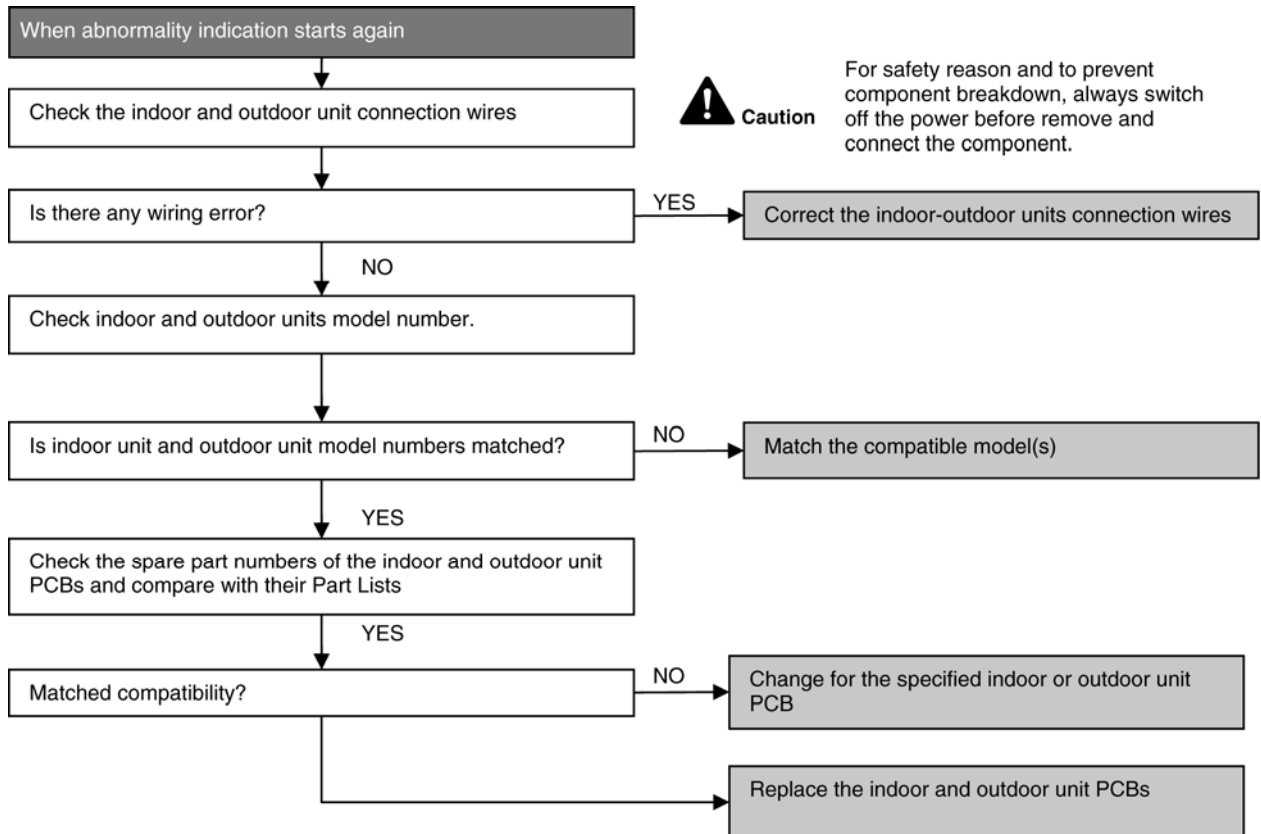

15.5.3 H14 (Indoor Intake Air Temperature Sensor Abnormality)

Malfunction Decision Conditions

- During startup and operation of cooling and heating, the temperatures detected by the indoor intake air temperature sensor are used to determine sensor errors.

Malfunction Caused

- Faulty connector connection.
- Faulty sensor.
- Faulty PCB.

Troubleshooting

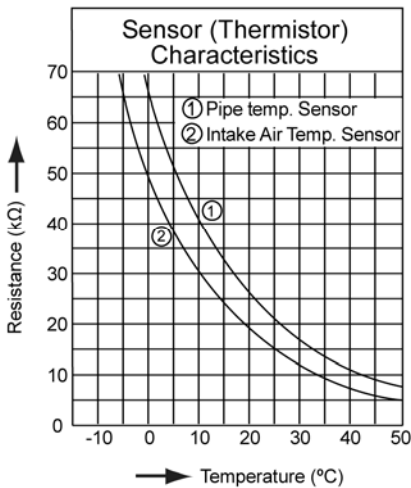
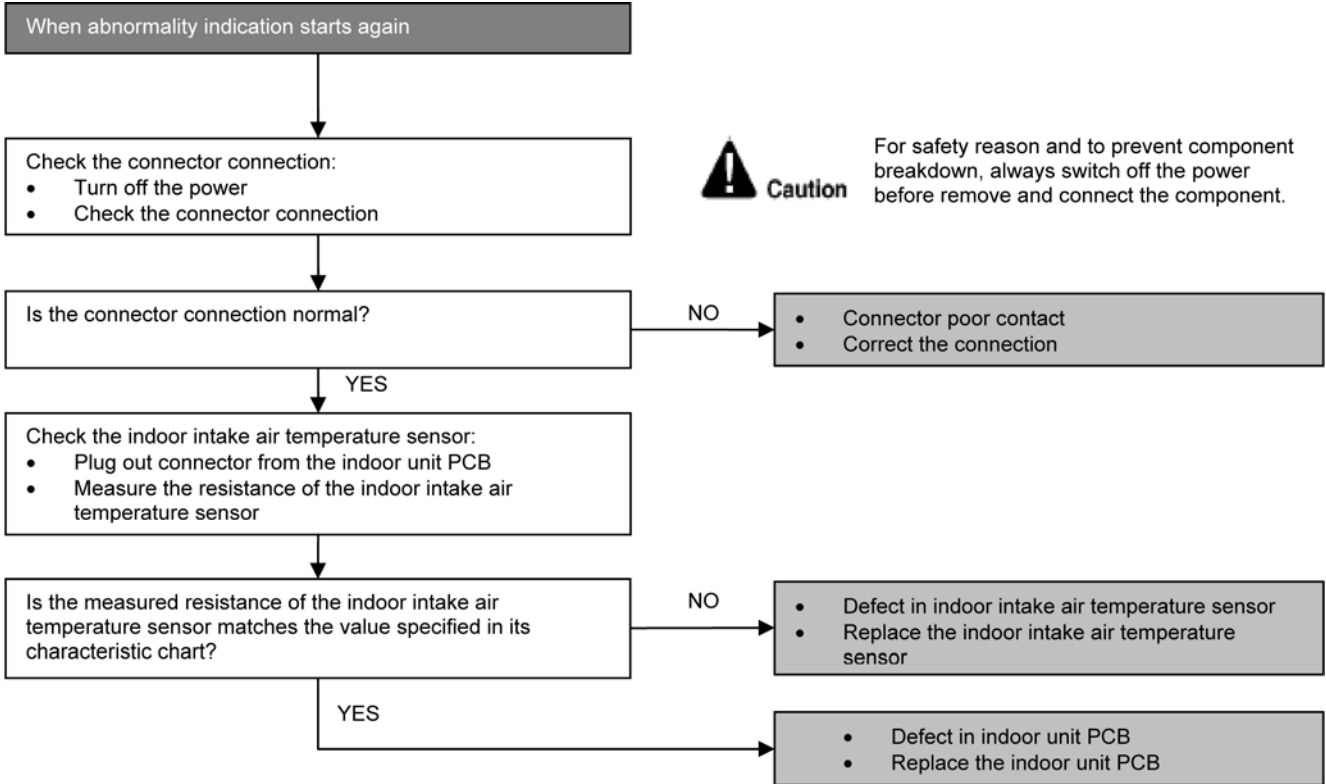

15.5.4 H15 (Compressor Temperature Sensor Abnormality)

Malfunction Decision Conditions

- During startup and operation of cooling and heating, the temperatures detected by the outdoor compressor temperature sensor are used to determine sensor errors.

Malfunction Caused

- Faulty connector connection.
- Faulty sensor.
- Faulty PCB.

Troubleshooting

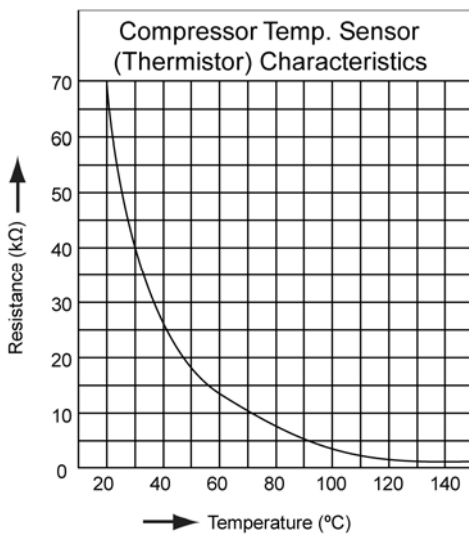
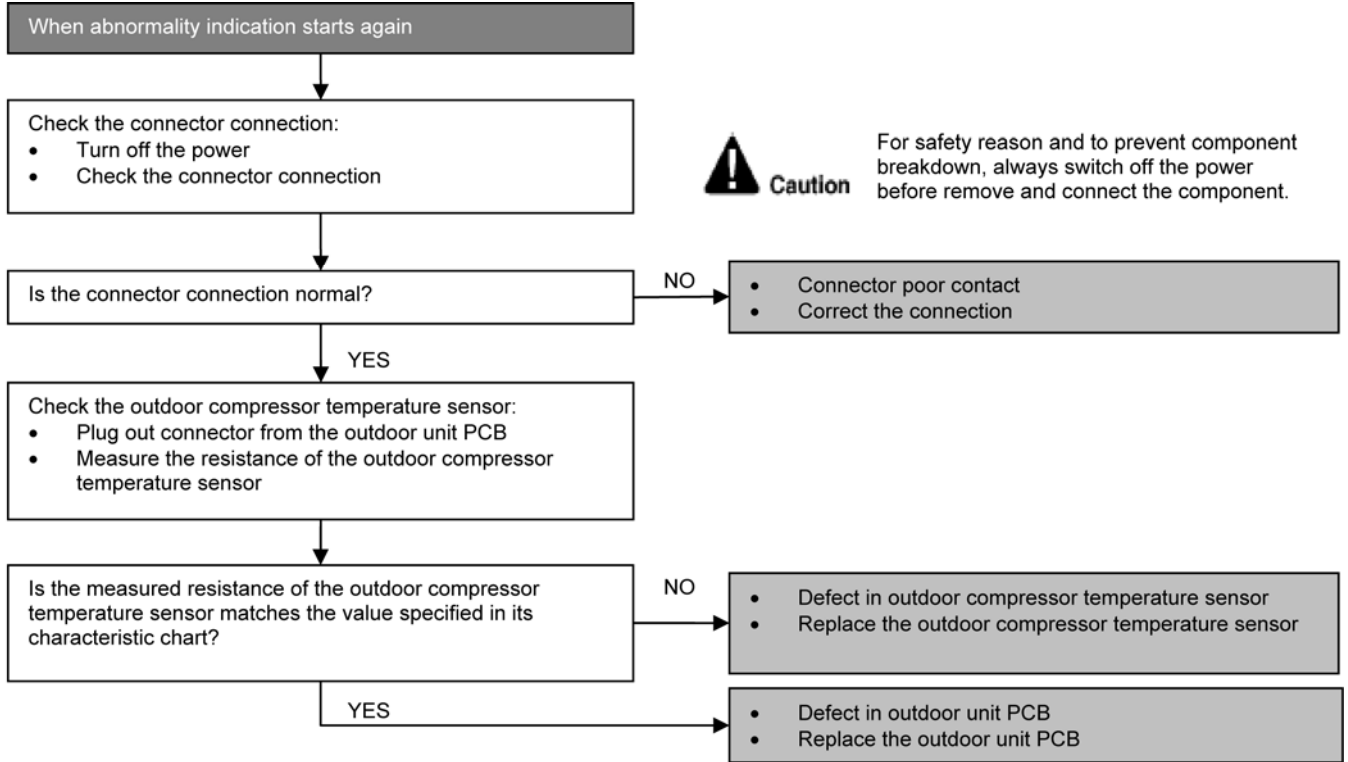

15.5.5 H16 (Outdoor Current Transformer)

Malfunction Decision Conditions

- An input current, detected by Current Transformer CT, is below threshold value when the compressor is operating at certain frequency value for 3 minutes.

Malfunction Caused

- Lack of gas
- Broken CT (current transformer)
- Broken Outdoor PCB

Troubleshooting

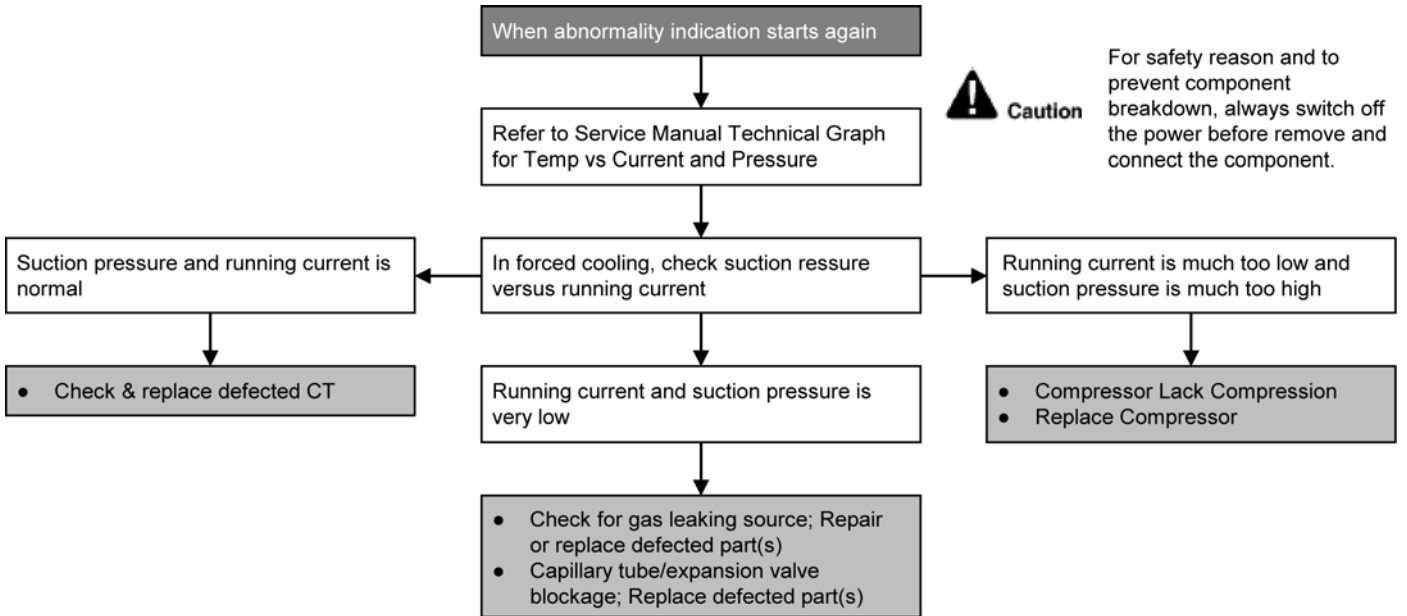

15.5.6 H19 (Indoor Fan Motor – DC Motor Mechanism Locked)

Malfunction Decision Conditions

- The rotation speed detected by the Hall IC during fan motor operation is used to determine abnormal fan motor (feedback of rotation > 2550rpm or < 50rpm).

Malfunction Caused

- Operation stops due to short circuit inside the fan motor winding.
- Operation stops due to breaking of wire inside the fan motor.
- Operation stops due to breaking of fan motor lead wires.
- Operation stops due to Hall IC malfunction.
- Operation error due to faulty indoor unit PCB.

Troubleshooting

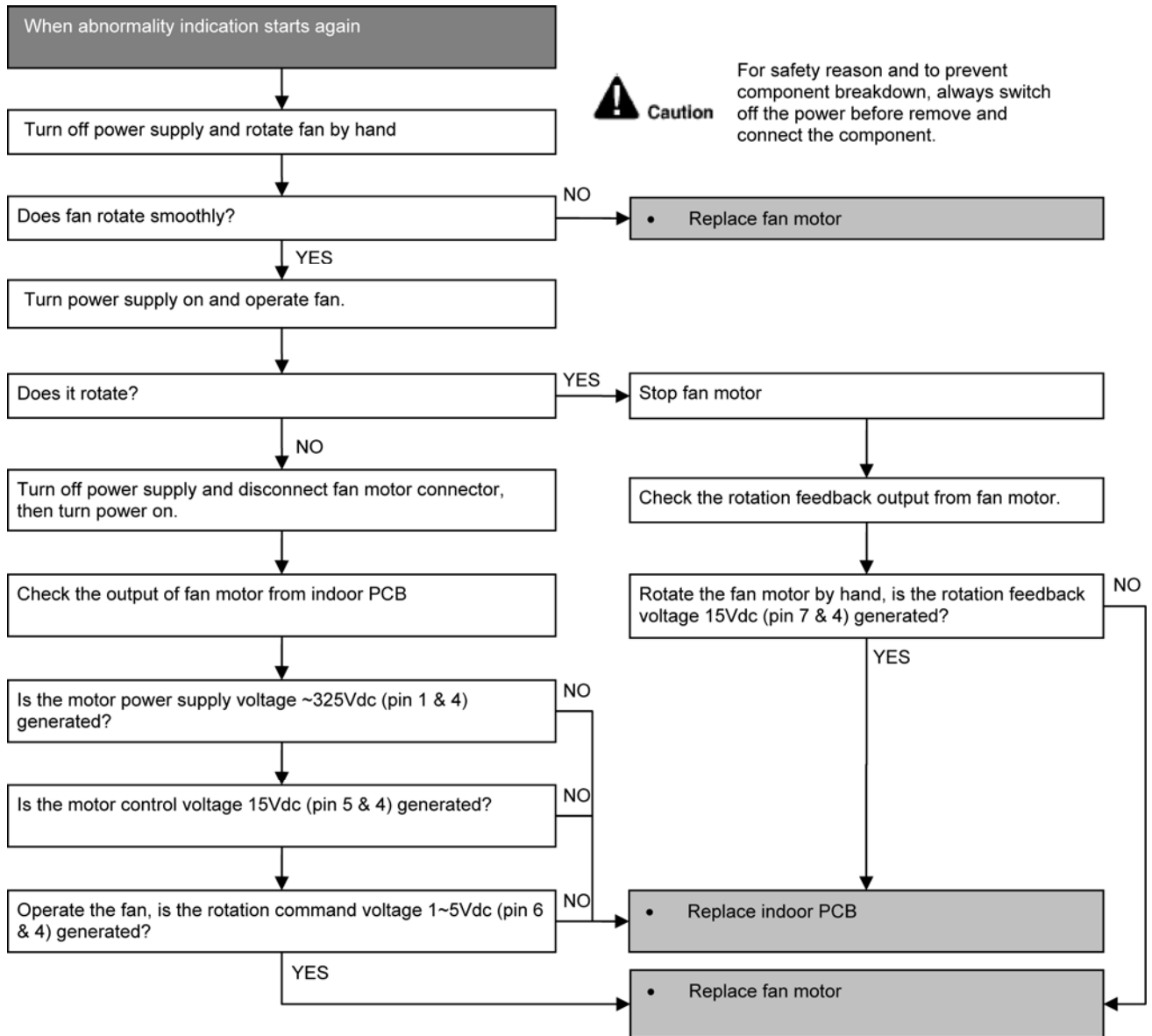

15.5.7 H23 (Indoor Pipe Temperature Sensor Abnormality)

Malfunction Decision Conditions

- During startup and operation of cooling and heating, the temperatures detected by the indoor heat exchanger temperature sensor are used to determine sensor errors.

Malfunction Caused

- Faulty connector connection.
- Faulty sensor.
- Faulty PCB.

Troubleshooting

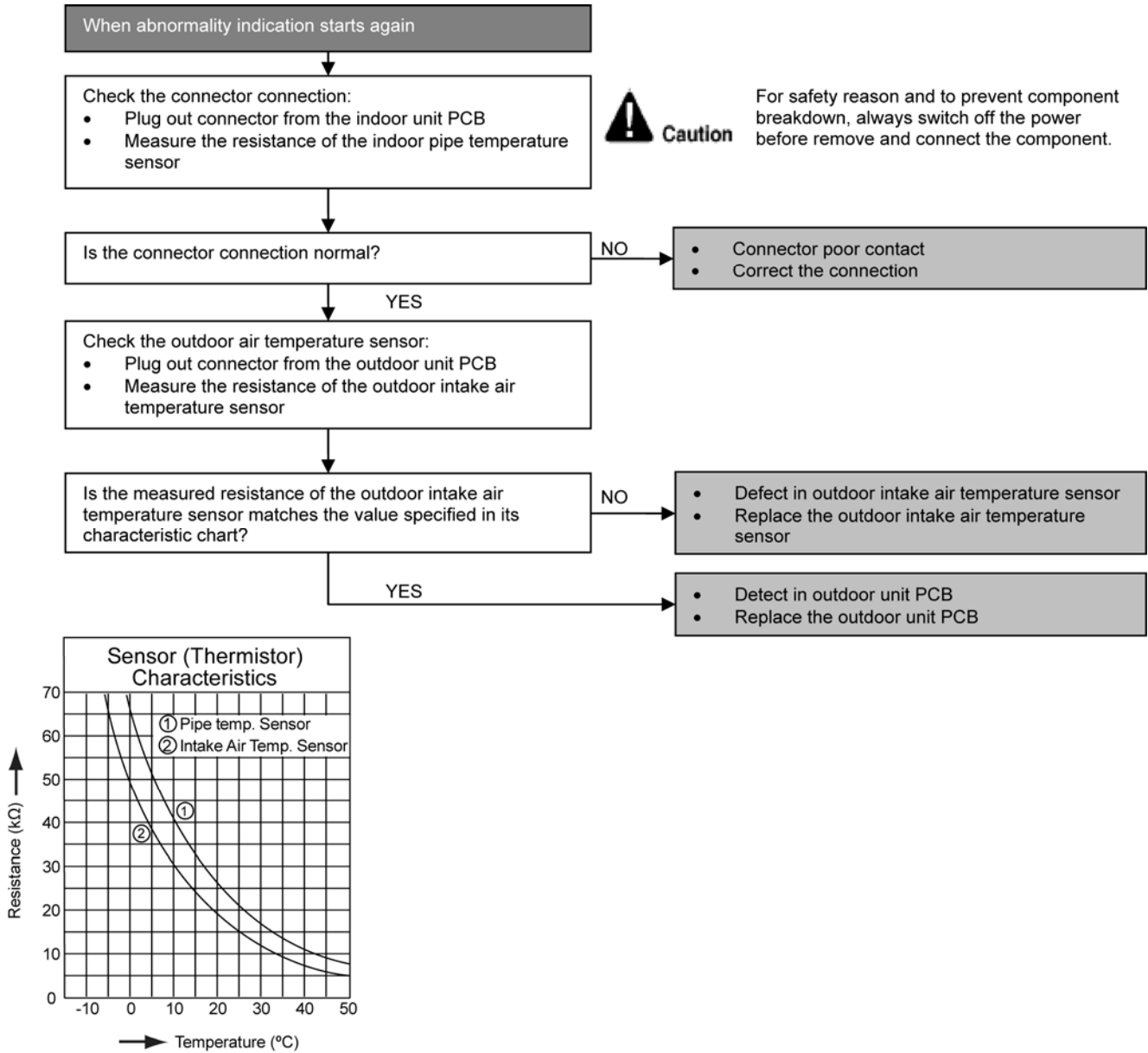

15.5.8 H27 (Outdoor Air Temperature Sensor Abnormality)

Malfunction Decision Conditions

- During startup and operation of cooling and heating, the temperatures detected by the outdoor air temperature sensor are used to determine sensor errors.

Malfunction Caused

- Faulty connector connection.
- Faulty sensor.
- Faulty PCB.

Troubleshooting

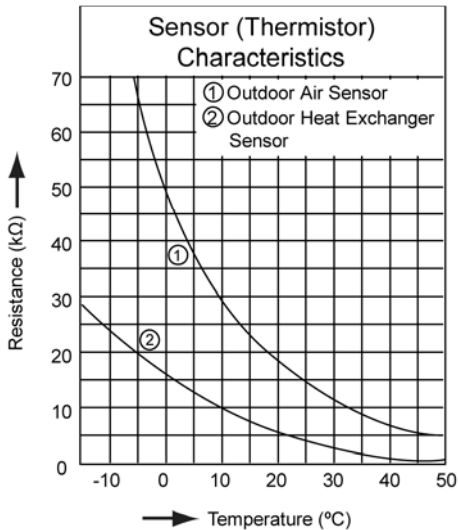
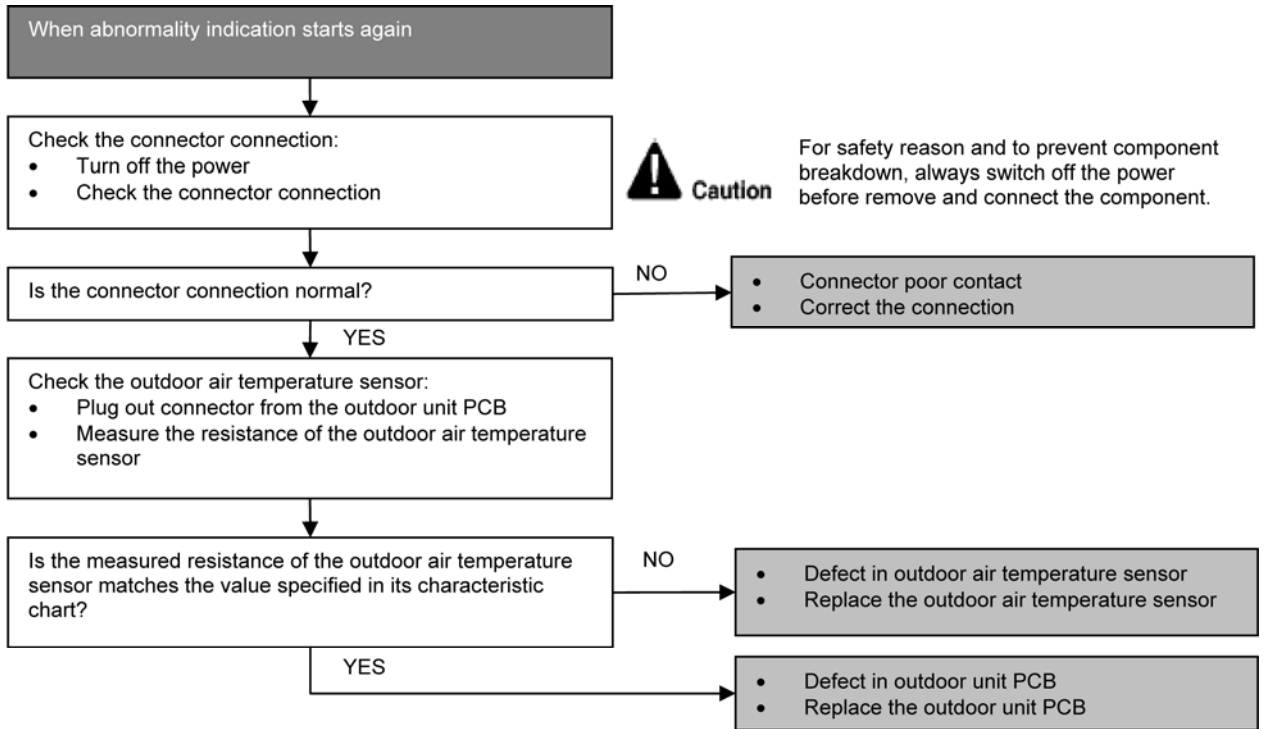

15.5.9 H28 (Outdoor Pipe Temperature Sensor Abnormality)

Malfunction Decision Conditions

- During startup and operation of cooling and heating, the temperatures detected by the outdoor pipe temperature sensor are used to determine sensor errors.

Malfunction Caused

- Faulty connector connection.
- Faulty sensor.
- Faulty PCB.

Troubleshooting

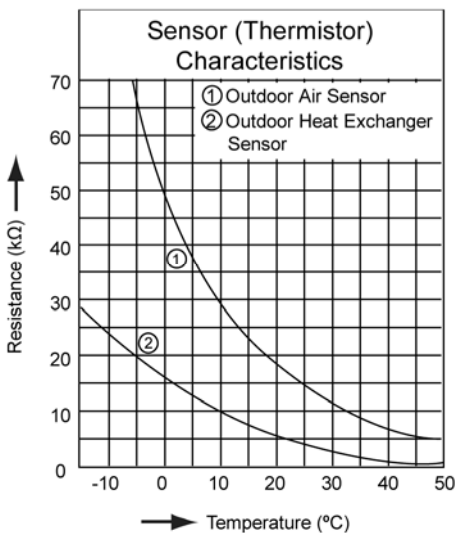
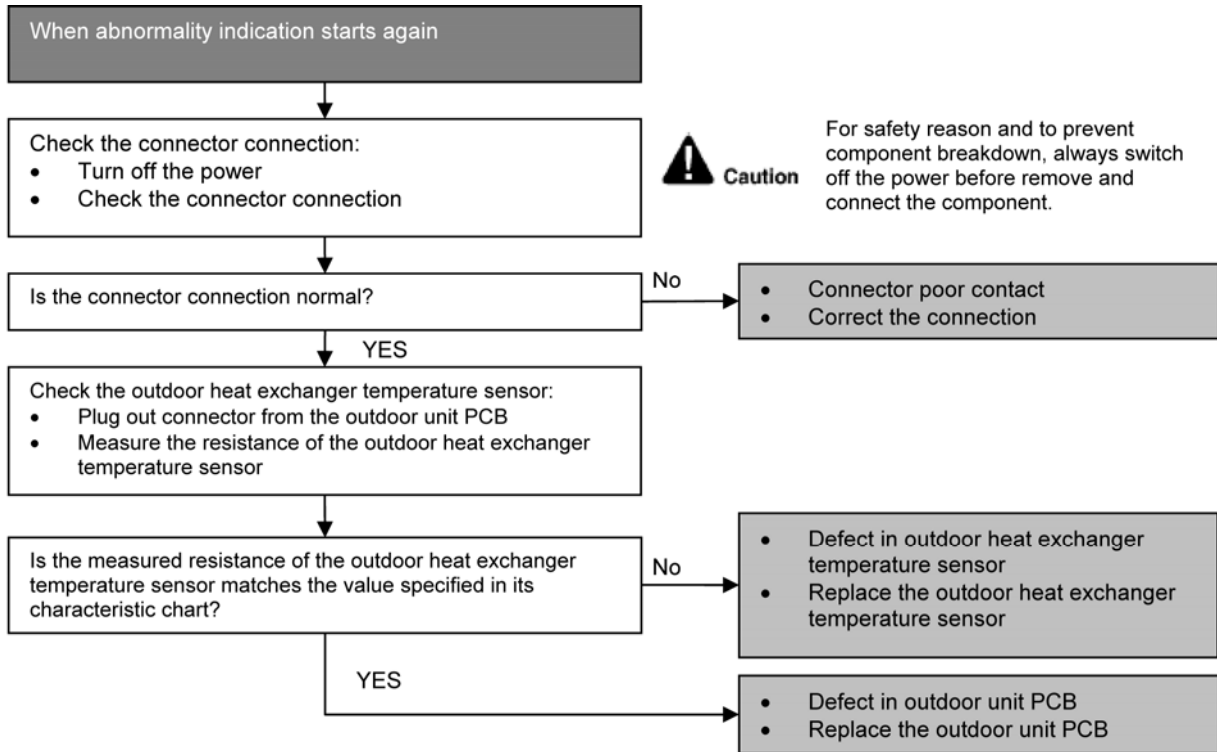

15.5.10 H30 (Compressor Discharge Temperature Sensor Abnormality)

Malfunction Decision Conditions

- During startup and operation of cooling and heating, the temperatures detected by the outdoor discharge pipe temperature sensor are used to determine sensor errors.

Malfunction Caused

- Faulty connector connection.
- Faulty sensor.
- Faulty PCB.

Troubleshooting

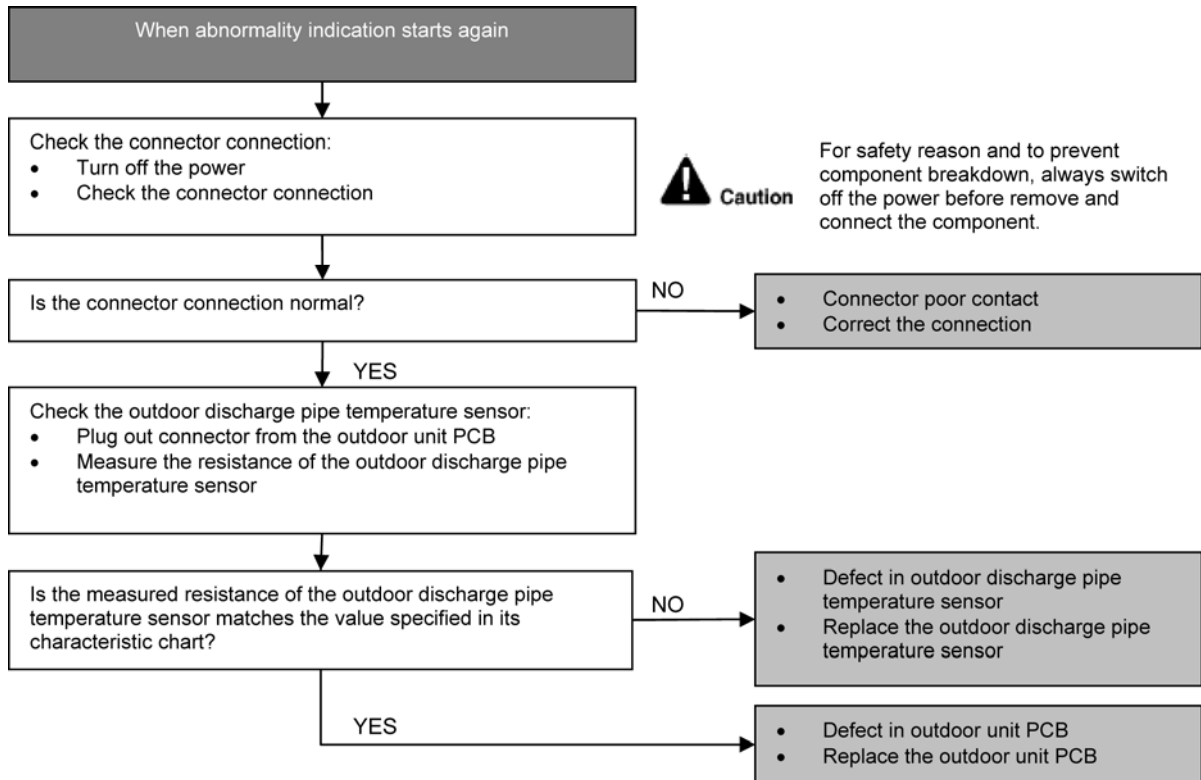

15.5.11 H32 (Outdoor Heat Exchanger Temperature Sensor 2 Abnormality)

Malfunction Decision Conditions

- During startup and operation of cooling and heating, the temperatures detected by the outdoor heat exchanger temperature sensor are used to determine sensor errors.

Malfunction Caused

- Faulty connector connection.
- Faulty sensor.
- Faulty PCB.

Troubleshooting

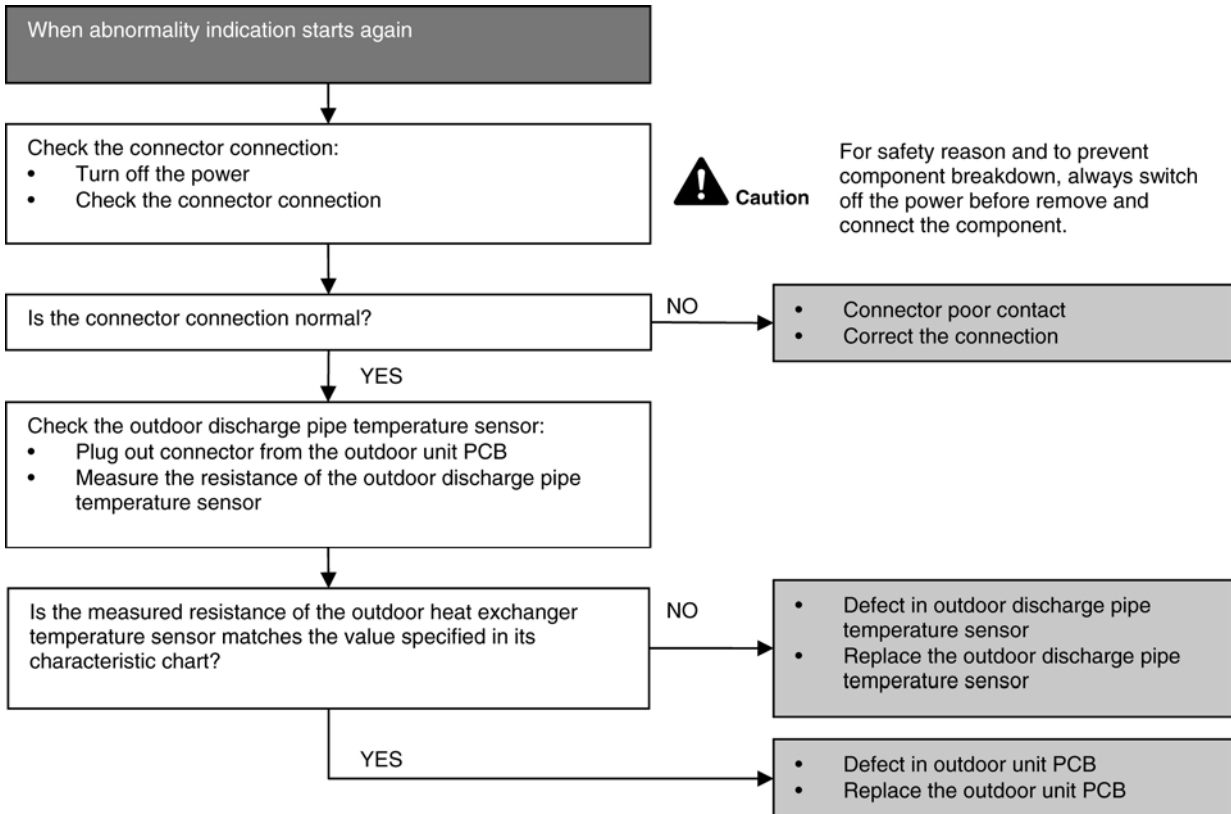

15.5.12 H33 (Unspecified Voltage between Indoor and Outdoor)

Malfunction Decision Conditions

- The supply power is detected for its requirement by the indoor/outdoor transmission.

Malfunction Caused

- Wrong models interconnected.
- Wrong indoor unit and outdoor unit PCBs used.
- Indoor unit or outdoor unit PCB defective.

Troubleshooting

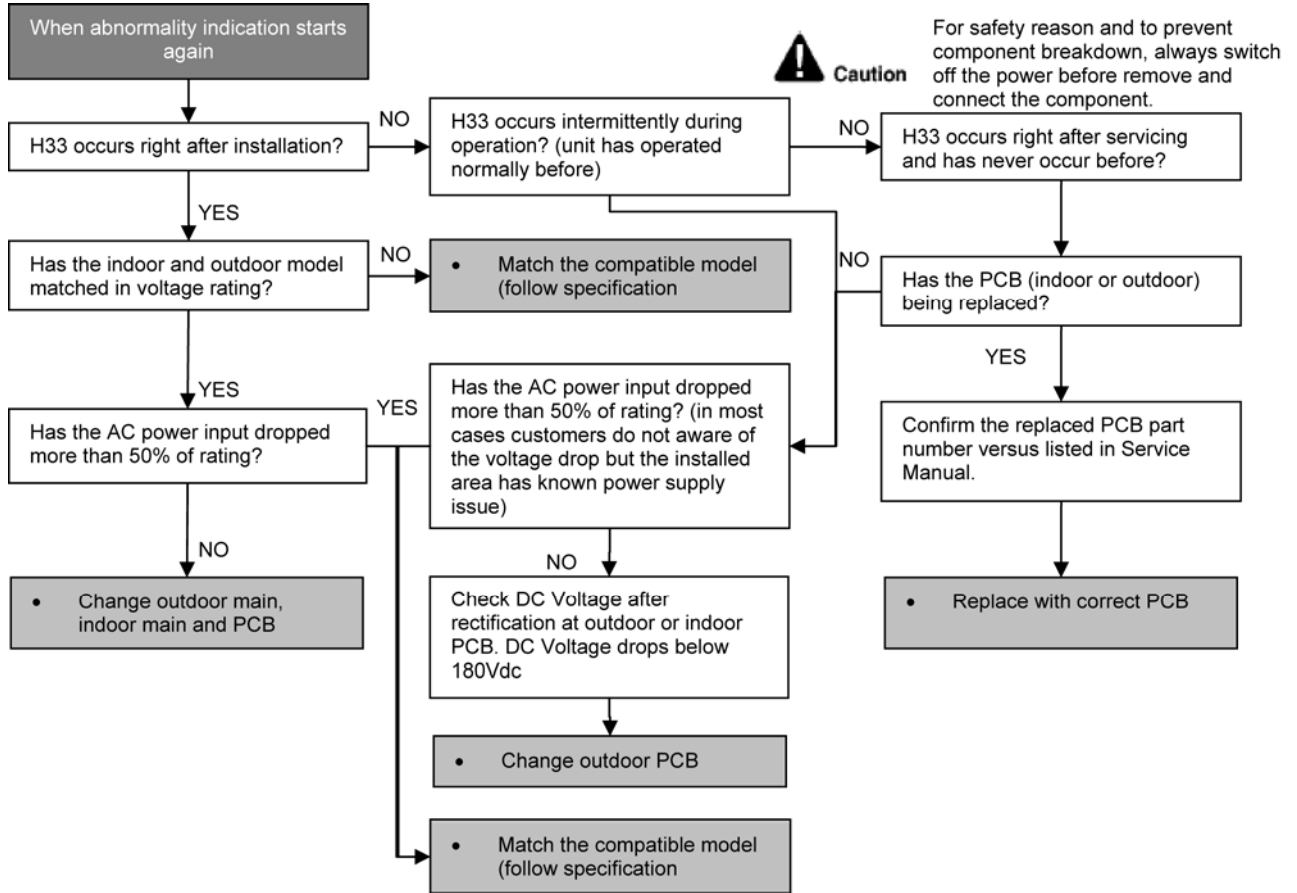

15.5.13 H34 (Outdoor Heat Sink Temperature Sensor Abnormality)

Malfunction Decision Conditions

- During startup and operation of cooling and heating, the temperatures detected by the outdoor heat sink temperature sensor are used to determine sensor errors.

Malfunction Caused

- Faulty connector connection.
- Faulty sensor.
- Faulty PCB.

Troubleshooting

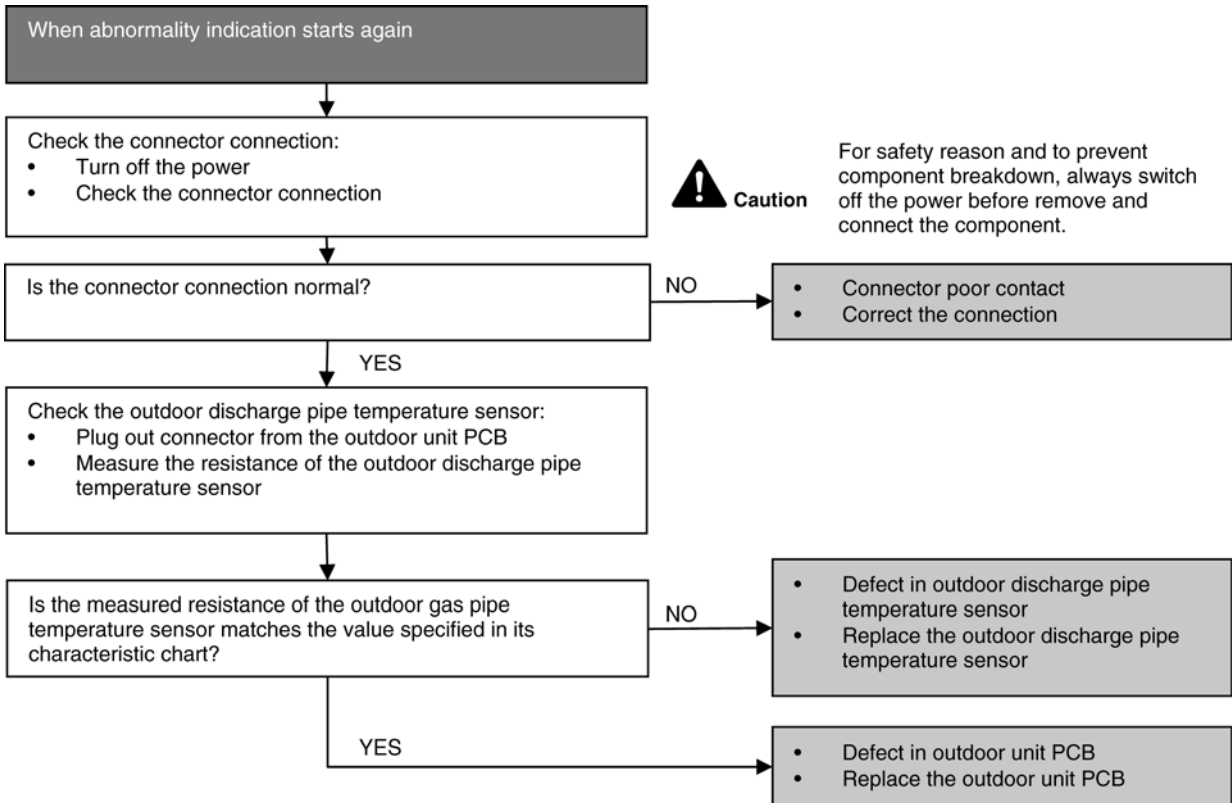

15.5.14 H36 (Outdoor Gas Pipe Sensor Abnormality)

Malfunction Decision Conditions

- During startup and operation of cooling and heating, the temperatures detected by the outdoor gas pipe temperature sensor are used to determine sensor errors.

Malfunction Caused

- Faulty connector connection.
- Faulty sensor.
- Faulty PCB.

Troubleshooting

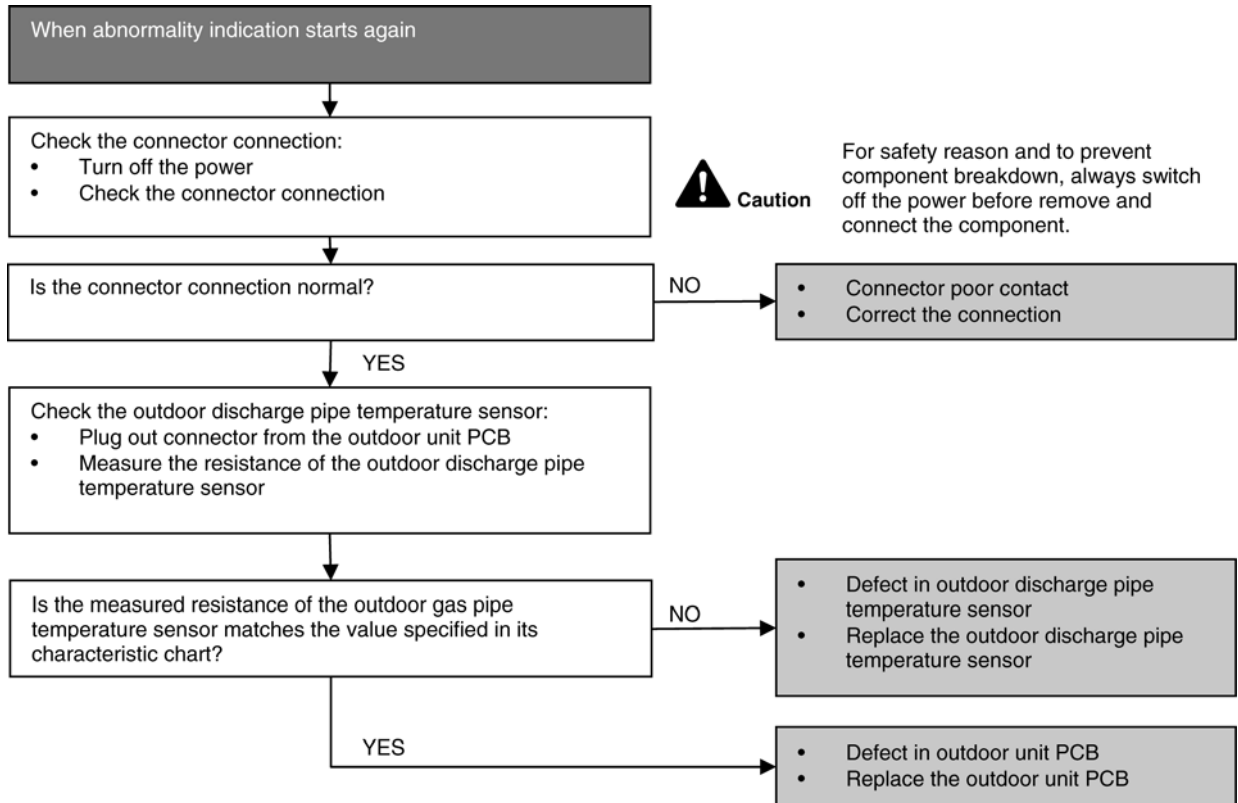

15.5.15 H37 (Outdoor Liquid Pipe Temperature Sensor Abnormality)

Malfunction Decision Conditions

- During startup and operation of cooling and heating, the temperatures detected by the outdoor liquid pipe temperature sensor are used to determine sensor errors.

Malfunction Caused

- Faulty connector connection.
- Faulty sensor.
- Faulty PCB.

Troubleshooting

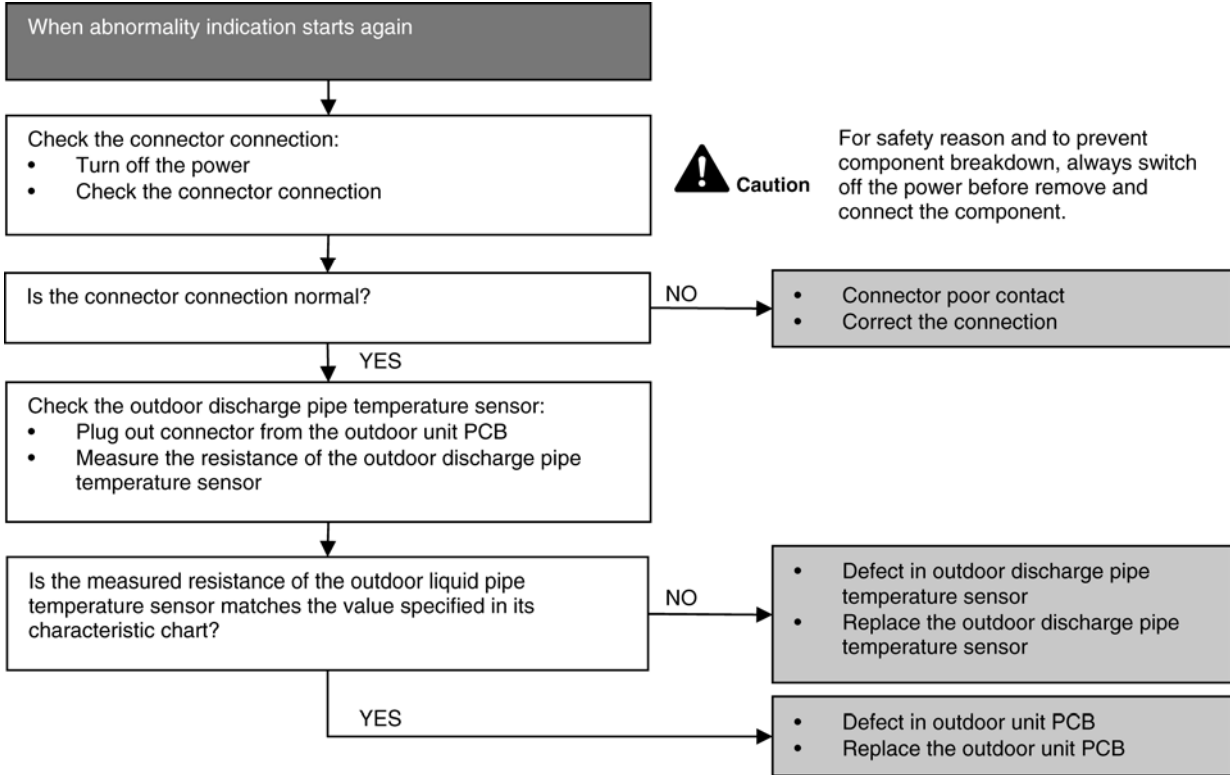

15.5.16 H97 (Outdoor Fan Motor – DC Motor Mechanism Locked)

Malfunction Decision Conditions

- The rotation speed detected by the Hall IC during fan motor operation is used to determine abnormal fan motor.

Malfunction Caused

- Operation stops due to short circuit inside the fan motor winding.
- Operation stops due to breaking of wire inside the fan motor.
- Operation stops due to breaking of fan motor lead wires.
- Operation stops due to Hall IC malfunction.
- Operation error due to faulty outdoor unit PCB.

Troubleshooting

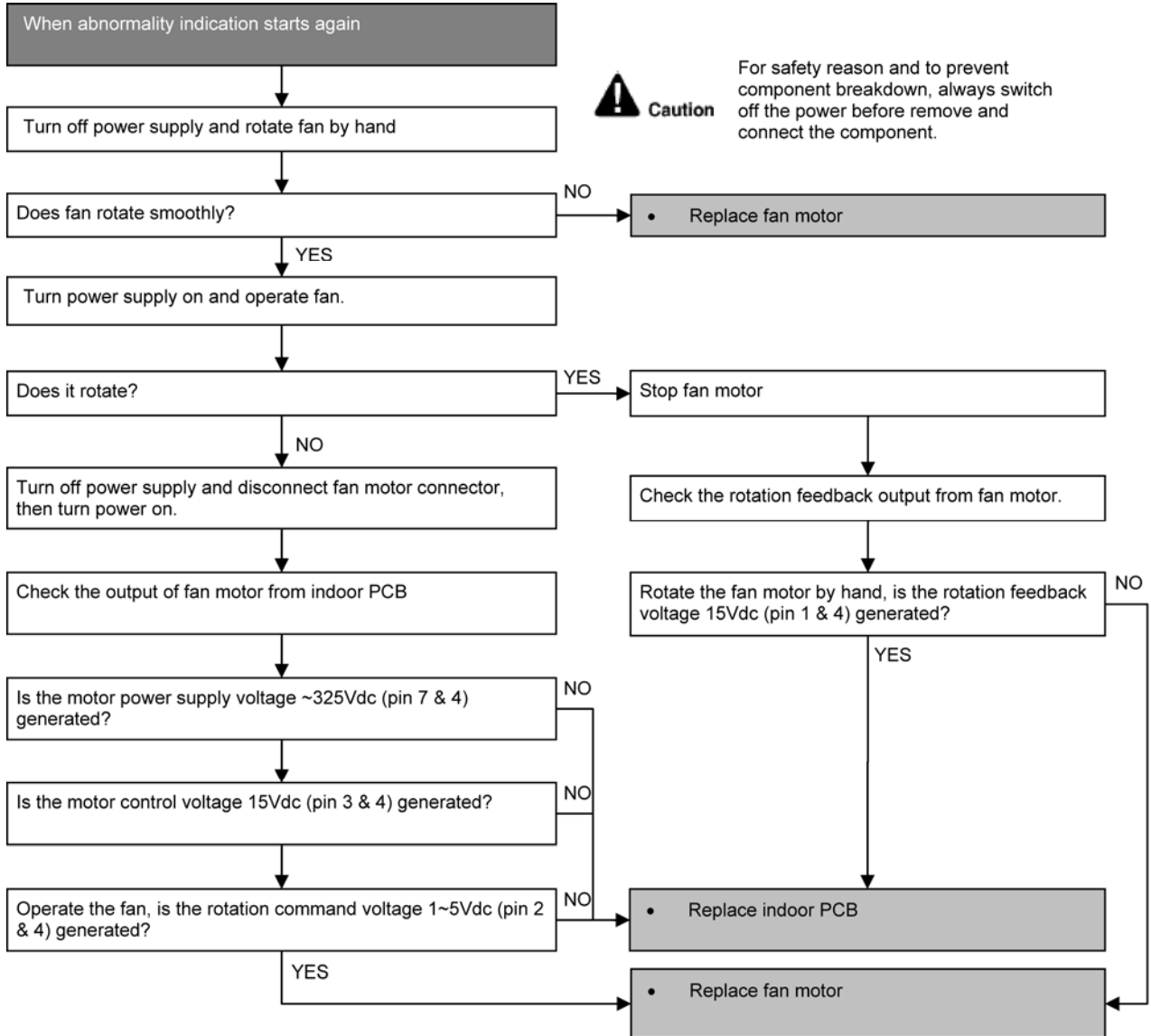

15.5.17 H98 (Error Code Stored in Memory and no alarm is triggered / no TIMER LED flashing)

Malfunction Decision Conditions

- Indoor high pressure is detected when indoor heat exchanger is detecting very high temperature when the unit is operating in heating operation.
- Phenomena: unit is stopping and re-starting very often in heating mode

Malfunction Caused

- Indoor heat exchanger thermistor
- Clogged air filter or heat exchanger
- Over-bent pipe (liquid side)

Troubleshooting

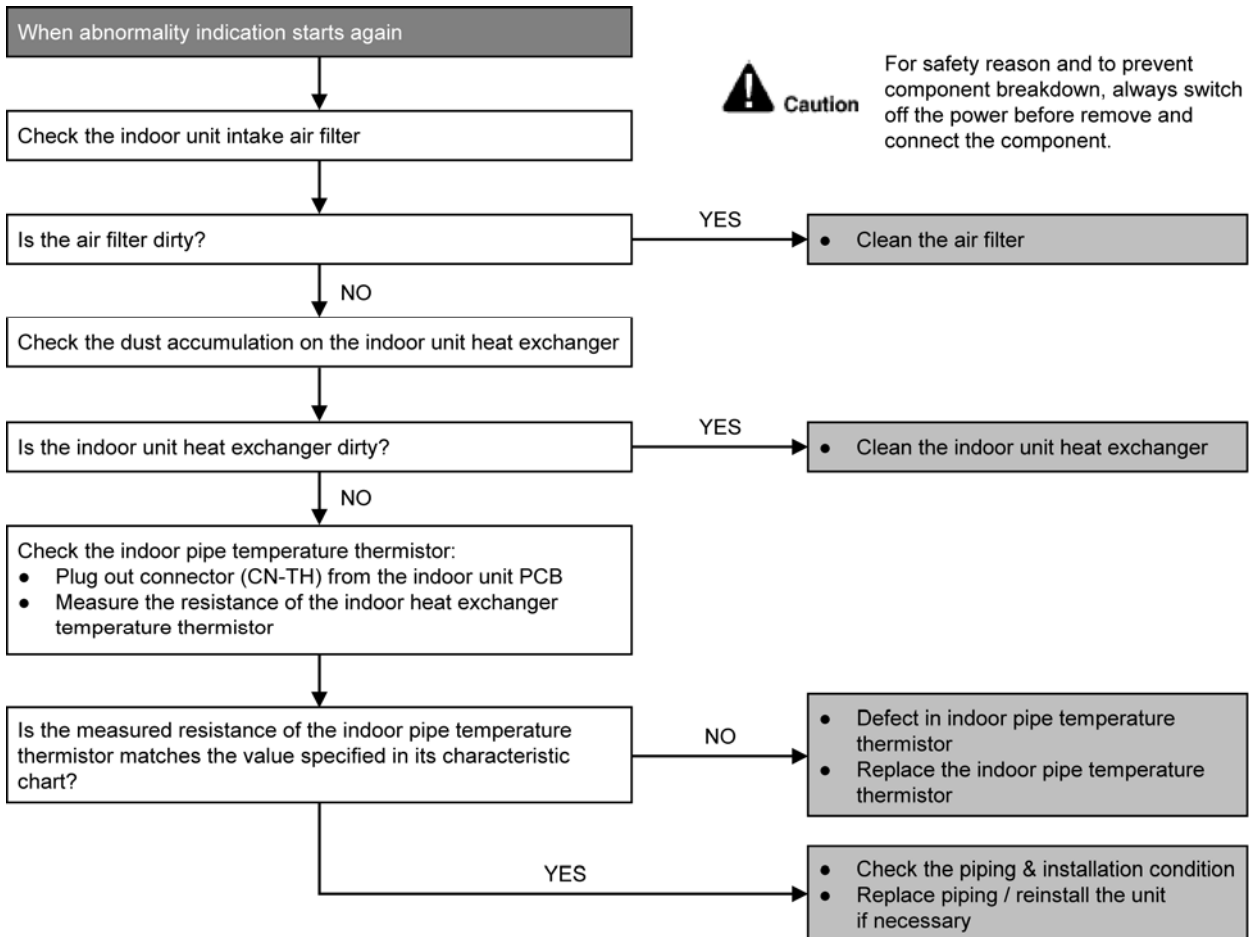

15.5.18 H99 (Indoor Freeze Prevention Protection: Cooling or Soft Dry)
Error code will not display (no TIMER LED blinking) but store in EEPROM

Malfunction Decision Conditions

- Freeze prevention control takes place (when indoor pipe temperature is lower than 2°C).

Malfunction Caused

- Clogged air filter of the indoor unit.
- Dust accumulation on the indoor unit heat exchanger.
- Air short circuit.
- Detection error due to faulty indoor pipe temperature sensor.
- Detection error due to faulty indoor unit PCB.

Troubleshooting

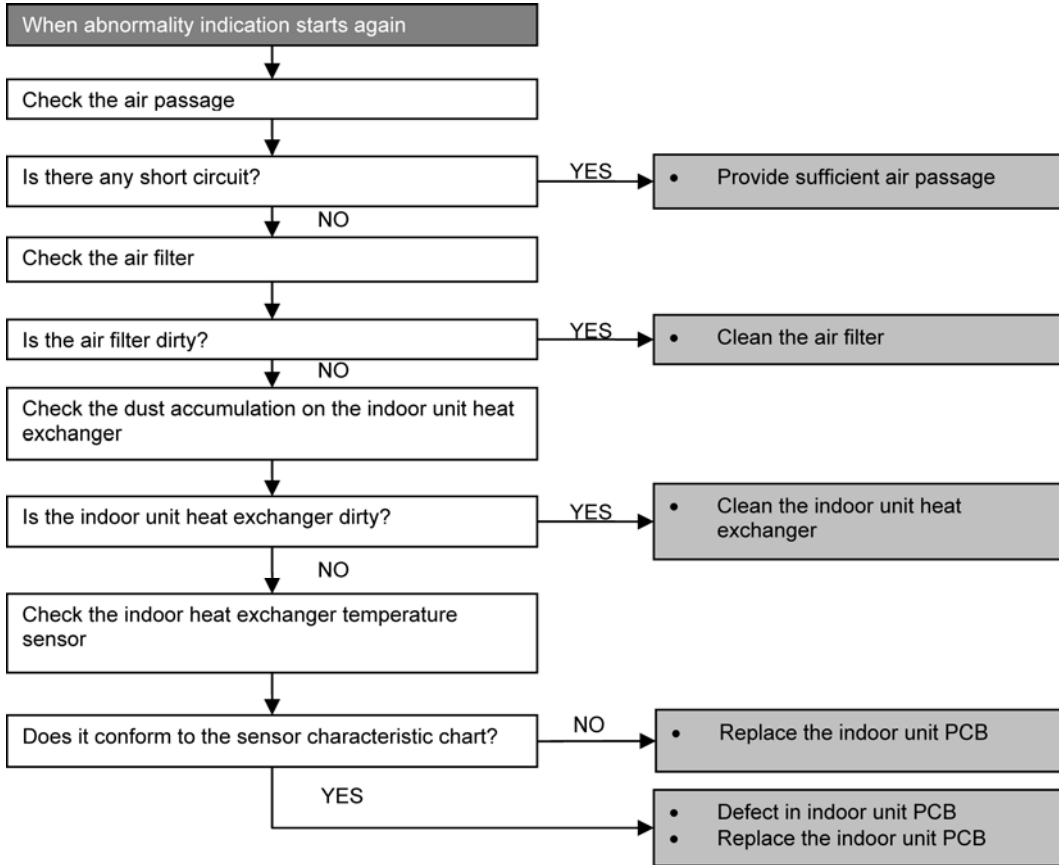

15.5.19 F11 (4-way valve Abnormality)

Malfunction Decision Conditions

- When indoor heat exchanger is cold during heating (except deice) or when indoor heat exchanger is hot during cooling and compressor operating, the 4-way valve is detected as malfunction.

Malfunction Caused

- Indoor heat exchanger (pipe) thermistor
- 4-way valve malfunction

Troubleshooting

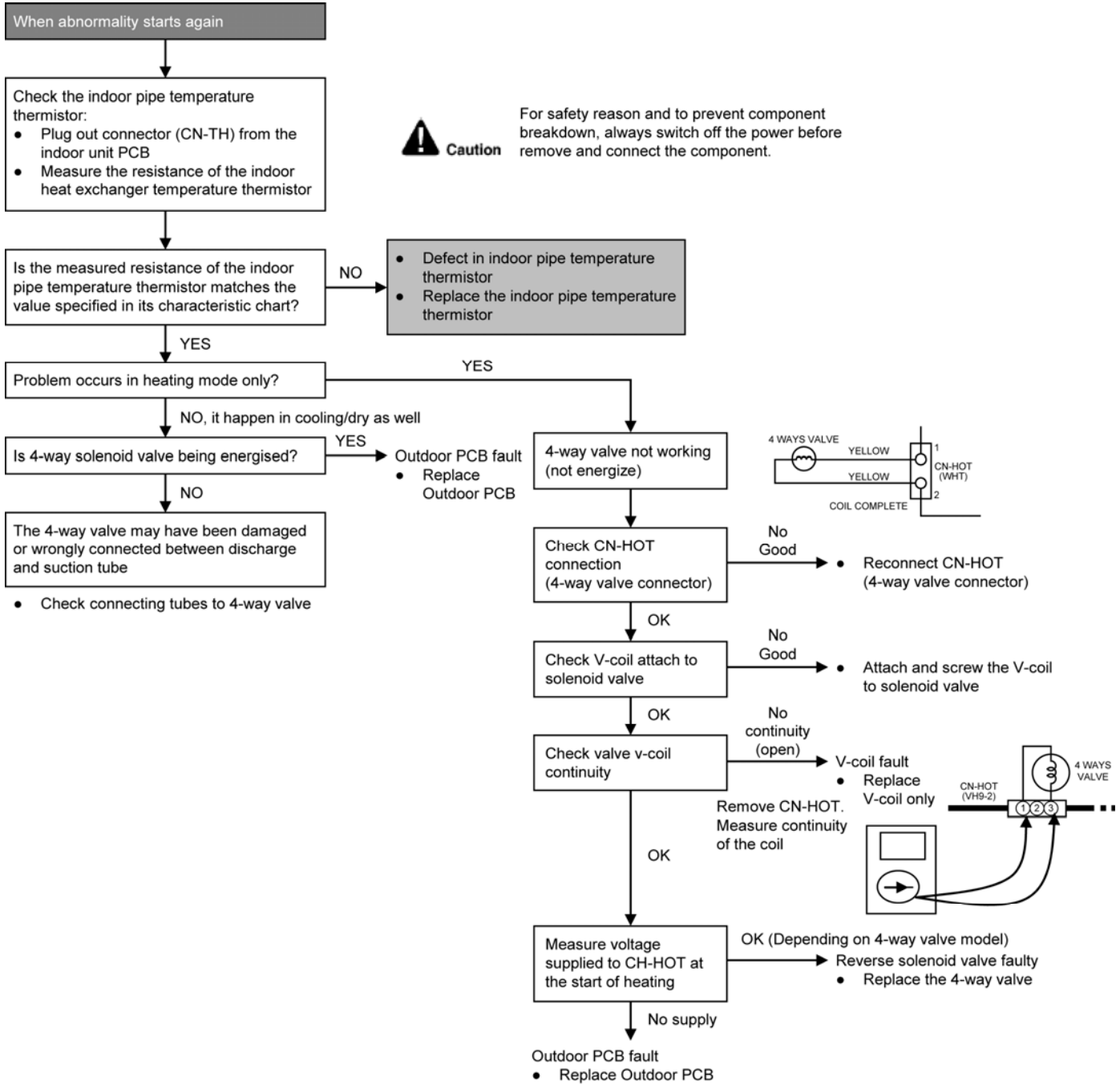

* Check gas side pipe – for hot gas flow in cooling mode

15.5.20 F17 (Indoor Standby Units Freezing Abnormality)

Malfunction Decision Conditions

- When the different between indoor intake air temperature and indoor pipe temperature is above 10°C or indoor pipe temperature is below -1.0°C.

Remark:

When the indoor standby unit is freezing, the outdoor unit transfers F17 error code to the corresponding indoor unit and H39 to other indoor unit(s).

Malfunction Caused

- Wrong wiring connection
- Faulty sensor
- Faulty expansion valve

Troubleshooting

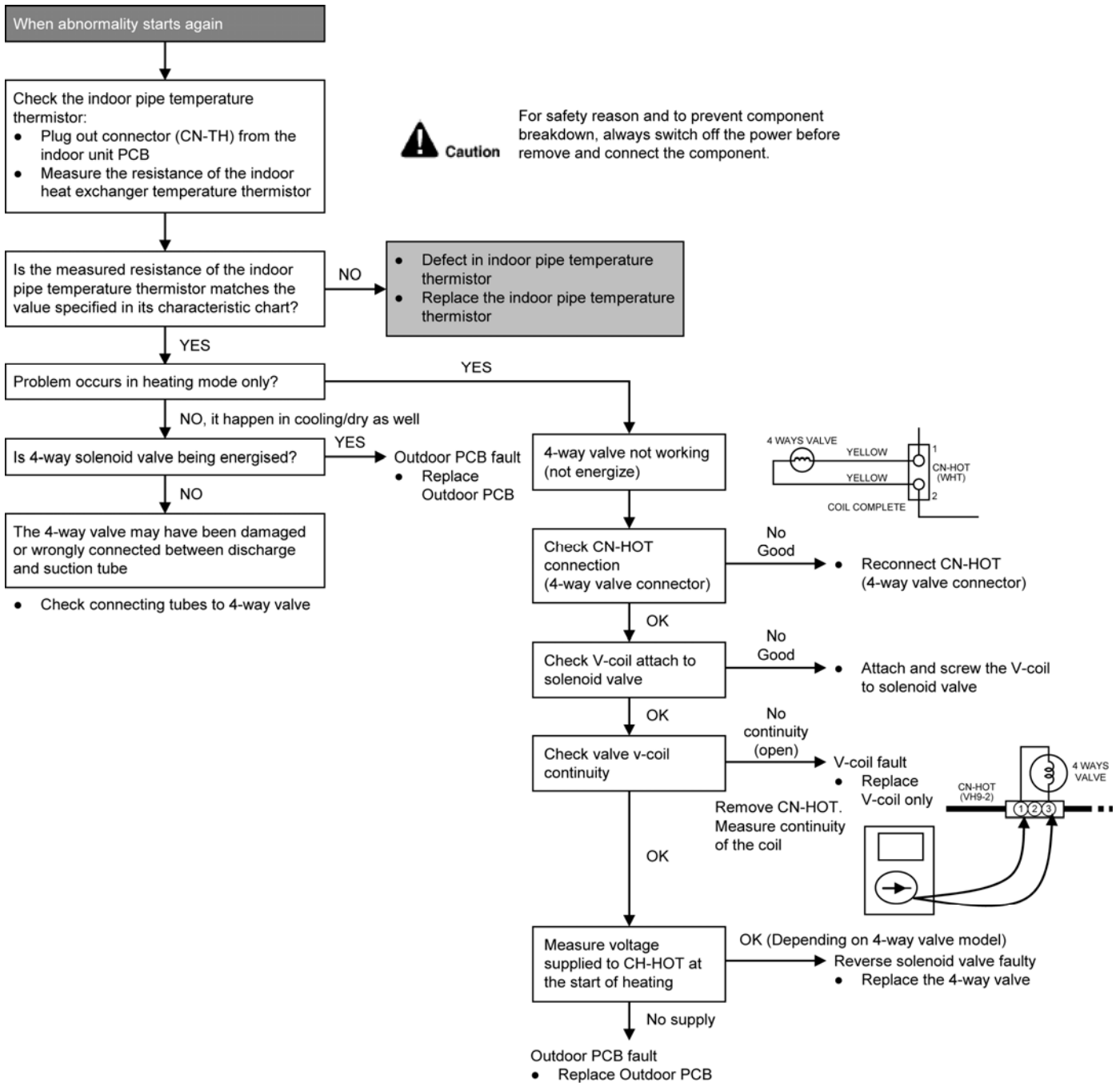

15.5.21 F90 (Power Factor Correction Protection)

Malfunction Decision Conditions

- To maintain DC voltage level supply to power transistor.
- To detect high DC voltage level after rectification.

Malfunction Caused

- During startup and operation of cooling and heating, when Power Factor Correction (PFC) protection circuitry at the outdoor unit main PCB senses abnormal DC voltage level for power transistors.
- When DC voltage detected is LOW, transistor switching will turn ON by controller to push-up the DC level.
- When DC voltage detected is HIGH (391Vdc – 425Vdc), active LOW signal will send by the controller to turn OFF relay RY-C.

Troubleshooting

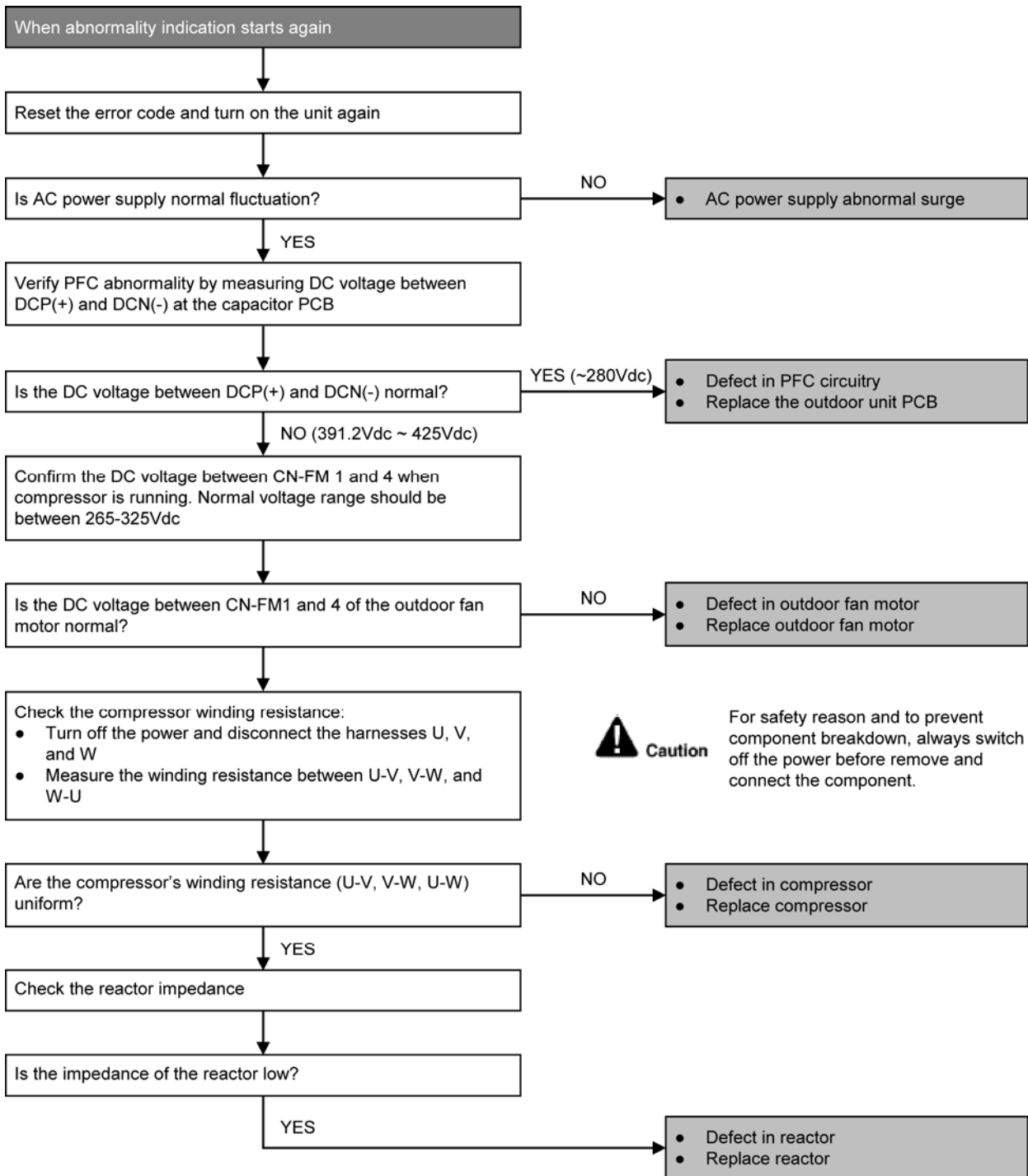

15.5.22 F91 (Refrigeration Cycle Abnormality)

Malfunction Decision Conditions

- The input current is low while the compressor is running at higher than the setting frequency.

Malfunction Caused

- Lack of gas.
- 3-way valve close.

Troubleshooting

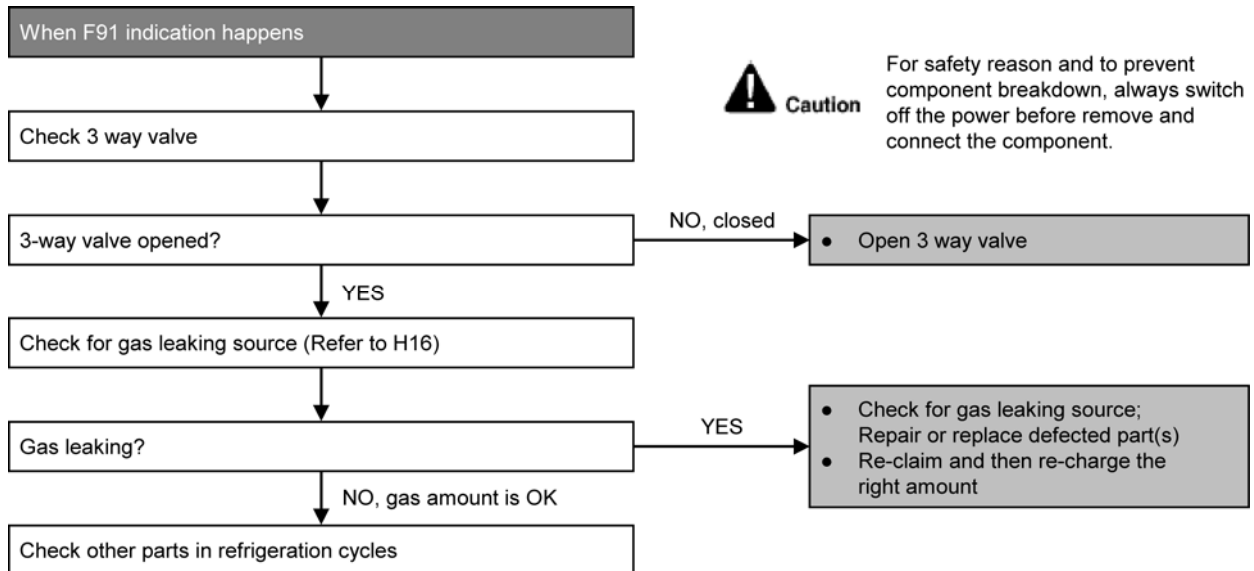

15.5.23 F93 (Compressor Rotation Failure)

Malfunction Decision Conditions

A compressor rotation failure is detected by checking the compressor running condition through the position detection circuit.

Malfunction Caused

- Compressor terminal disconnect.
- Outdoor PCB malfunction.

Troubleshooting

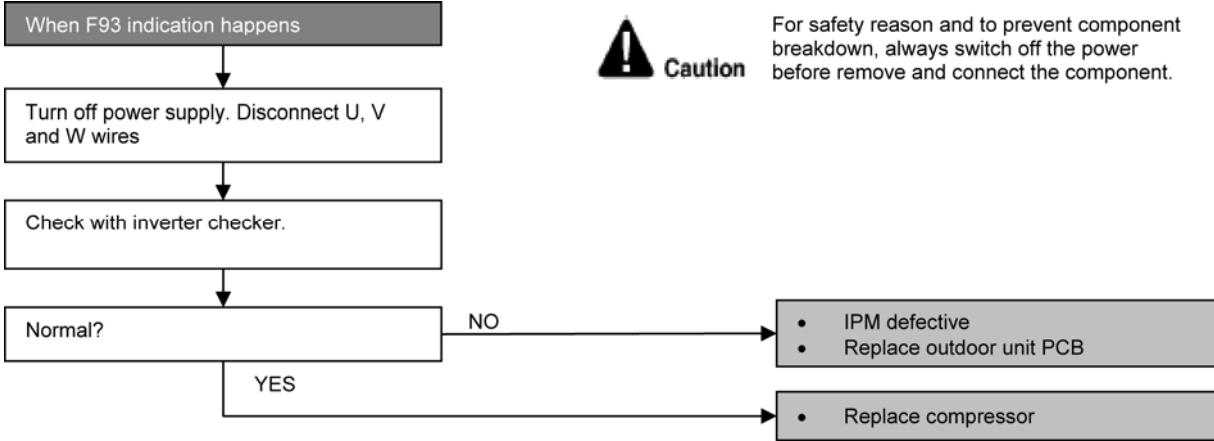

15.5.24 F95 (Outdoor High Pressure Protection: Cooling or Soft Dry)

Malfunction Decision Conditions

- During operation of cooling or soft dry, when outdoor unit heat exchanger high temperature data is detected by the outdoor unit heat exchanger thermistor.

Malfunction Caused

- Outdoor heat exchanger temperature rise due to short-circuit of hot discharge air flow.
- Outdoor heat exchanger temperature rise due to defective of outdoor fan motor.
- Outdoor heat exchange temperature rise due to defective outdoor heat exchanger thermistor.
- Outdoor heat exchanger temperature rise due to defective of outdoor unit PCB.

Troubleshooting

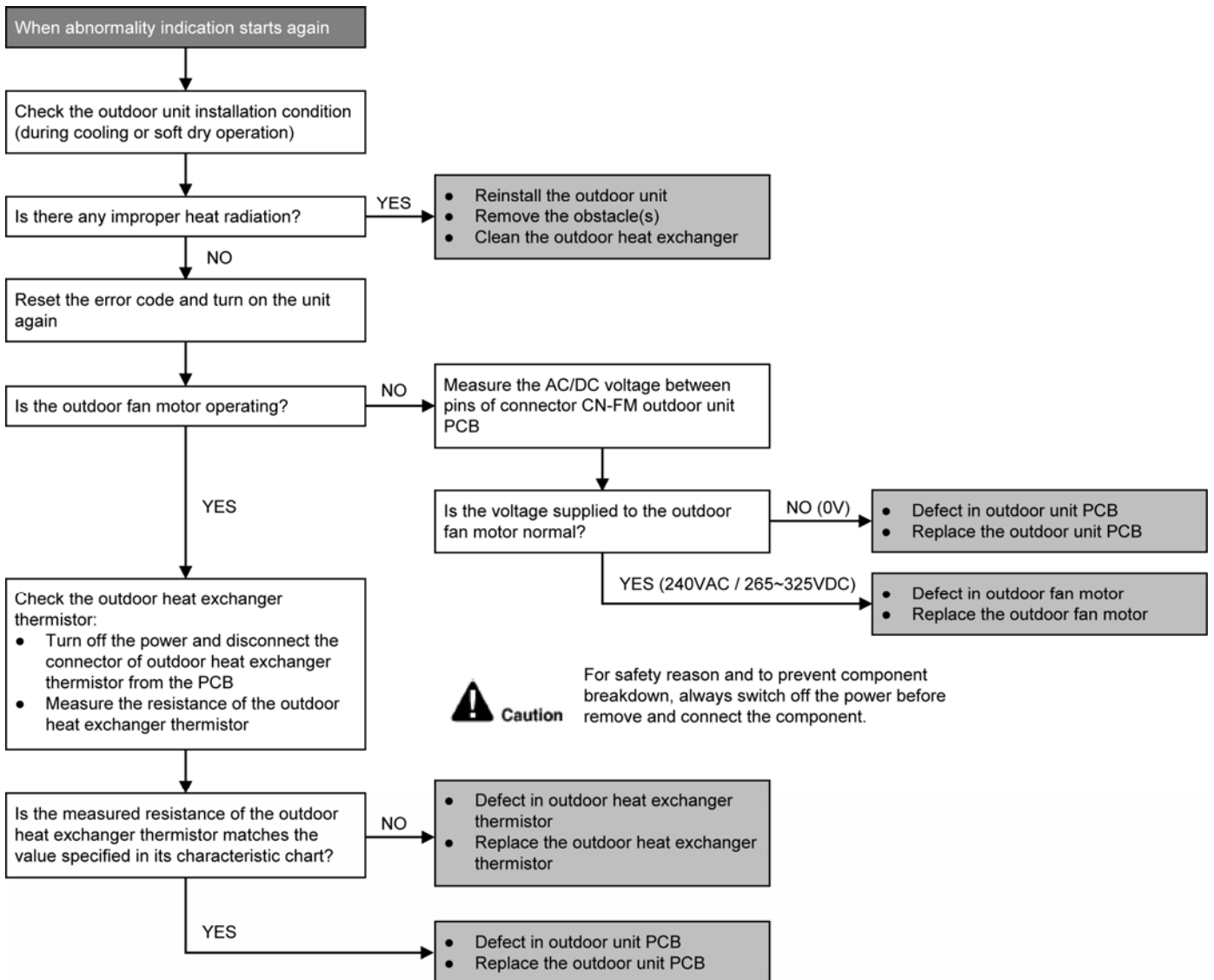

15.5.25 F96 (IPM Overheating)

Malfunction Decision Conditions

- During operating of cooling and heating, when IPM temperature data (100°C) is detected by the IPM temperature sensor.

Multi Models Only

- Compressor Overheating: During operation of cooling and heating, when the compressor OL is activated.
- Heat Sink Overheating: During operation of cooling and heating, when heat sink temperature data (90°C) is detected by the heat sink temperature sensor.

Malfunction Caused

- IPM overheats due to short circuit of hot discharge air flow.
- IPM overheats due to defective of outdoor fan motor.
- IPM overheats due to defective of internal circuitry of IPM.
- IPM overheats due to defective IPM temperature sensor.

Multi Models Only

- Compressor OL connector poor contact.
- Compressor OL faulty.

Troubleshooting

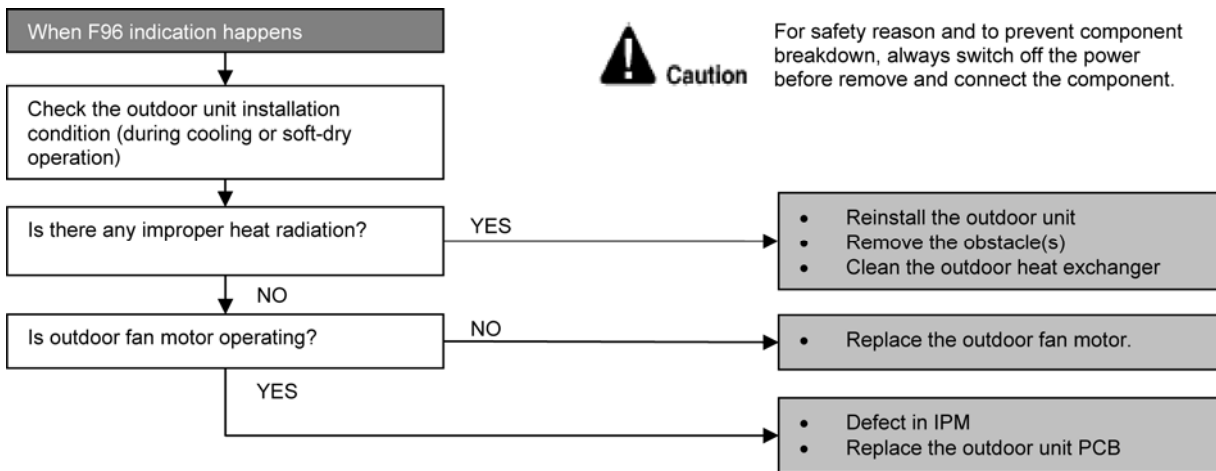

15.5.26 F97 (Compressor Overheating)

Malfunction Decision Conditions

During operation of cooling and heating, when compressor tank temperature data (112°C) is detected by the compressor tank temperature sensor.

Malfunction Caused

- Refrigerant shortage (refrigerant leakage).
- 2/3 way valve closed.
- Detection error due to faulty compressor tank temperature sensor.

Troubleshooting

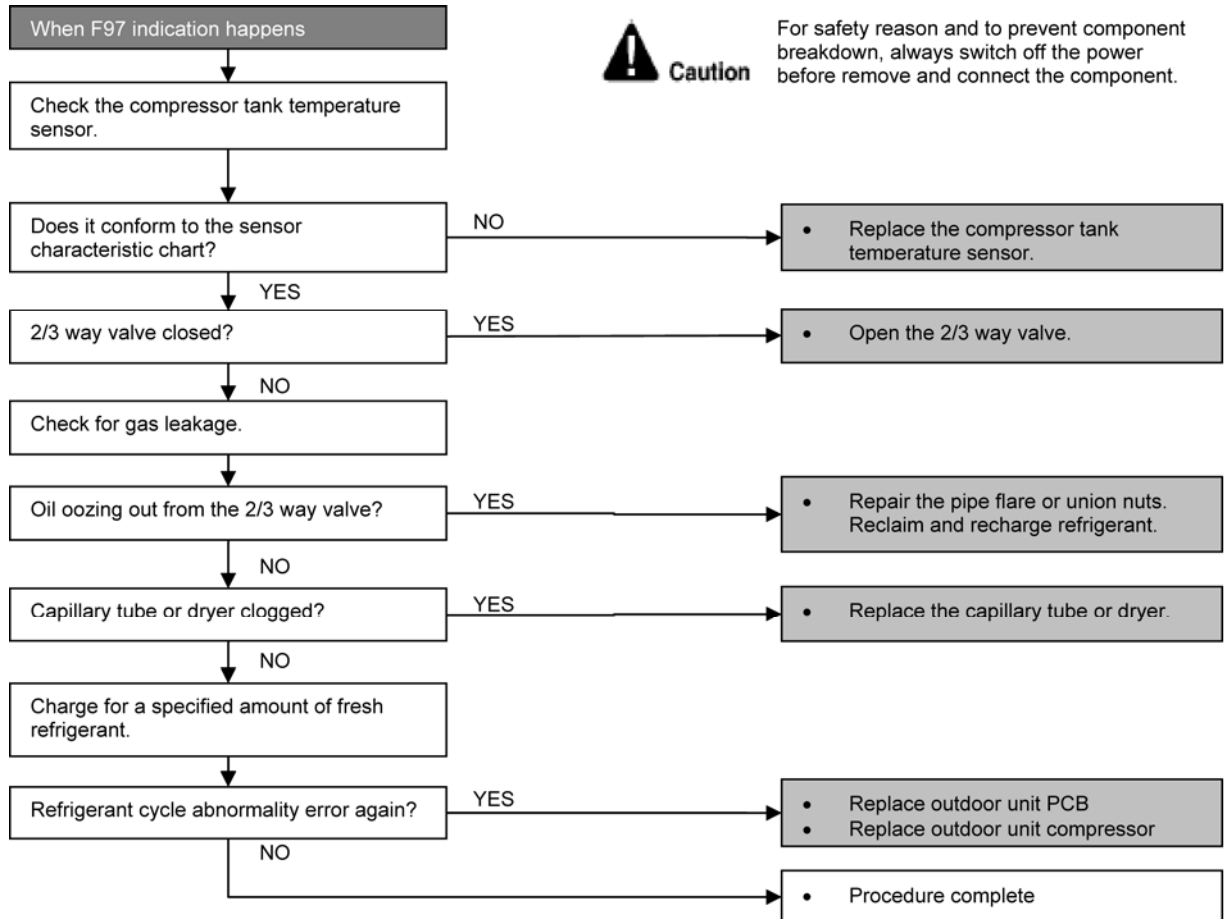

15.5.27 F98 (Input Over Current Detection)

Malfunction Decision Conditions

During operation of cooling and heating, when an input over-current (X value in Total Running Current Control) is detected by checking the input current value being detected by current transformer (CT) with the compressor running.

Malfunction Caused

- Over-current due to compressor failure.
- Over-current due to defective outdoor unit PCB.
- Over-current due to defective inverter main circuit electrolytic capacitor.
- Over-current due to excessive refrigerant.

Troubleshooting

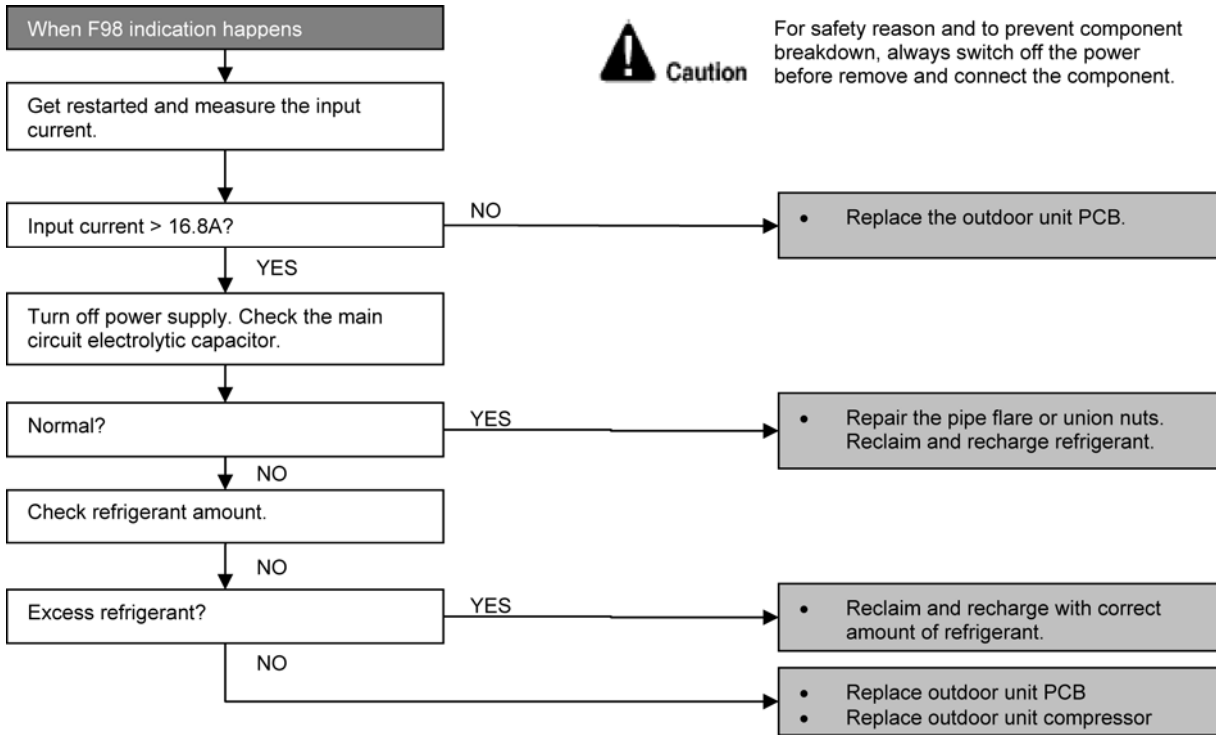

15.5.28 F99 (DC Peak Detection)

Malfunction Decision Conditions

During startup and operation of cooling and heating, when inverter DC peak data is received by the outdoor internal DC Peak sensing circuitry.

Malfunction Caused

- DC current peak due to compressor failure.
- DC current peak due to defective power transistor(s).
- DC current peak due to defective outdoor unit PCB.
- DC current peak due to short circuit.

Troubleshooting

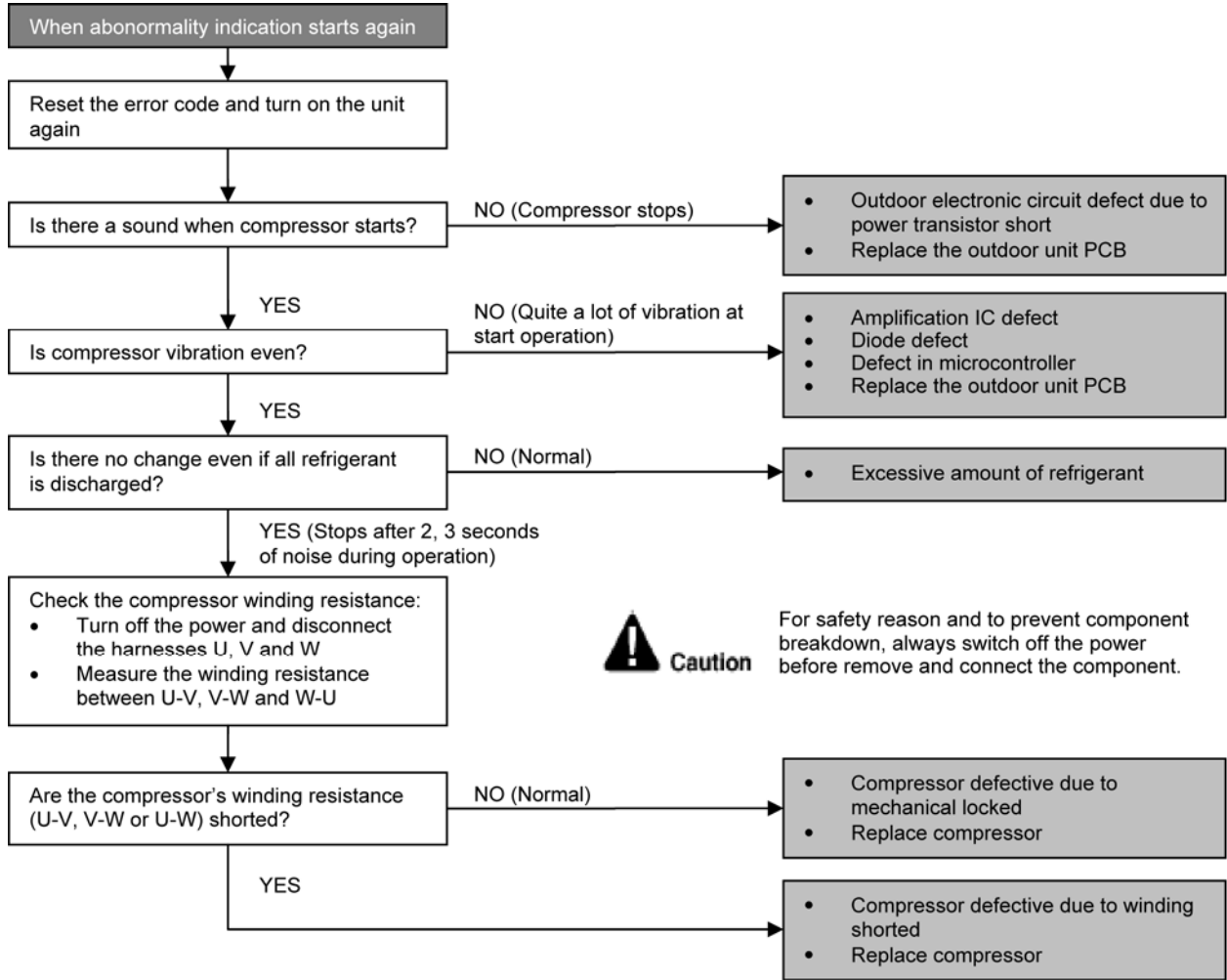

- Checking the power transistor.
- Never touch any live parts for at least 10 minutes after turning off the circuit breaker.
- If unavoidable necessary to touch a live part, make sure the power transistor's supply voltage is below 50V using the tester.
- For the UVW, make measurement at the Faston terminal on the board of the relay connector.

Tester's negative terminal	Power transistor (+)	UVW	Power transistor (-)	UVW
Tester's positive terminal	UVW	Power transistor (+)	UVW	Power transistor (-)
Normal resistance	Several kΩ to several MΩ			
Abnormal resistance	0 or ∞			

16. Disassembly and Assembly Instructions



WARNING

High Voltage are generated in the electrical parts area by the capacitor. Ensure that the capacitor has discharged sufficiently before proceeding with repair work. Failure to heed this caution may result in electric shocks.

16.1 Indoor Electronic Controllers, Cross Flow Fan and Indoor Fan Motor Removal Procedures

16.1.1 To remove front grille

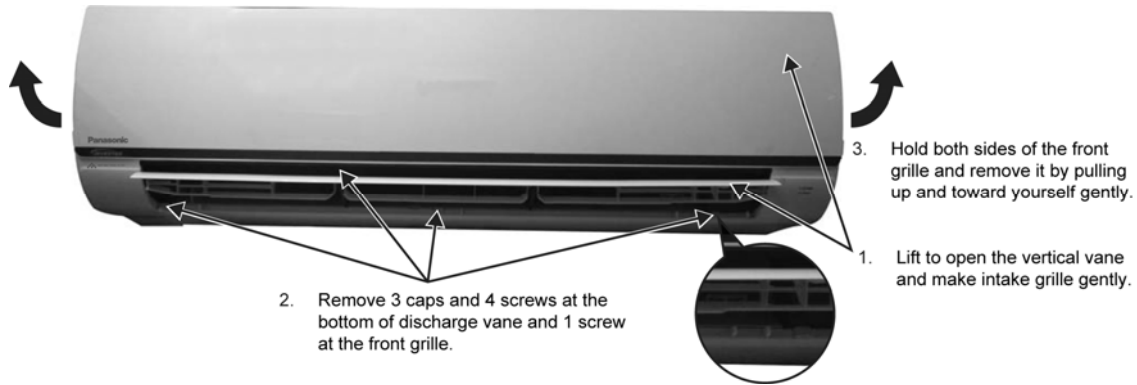

Figure 1

16.1.2 To remove horizontal vane

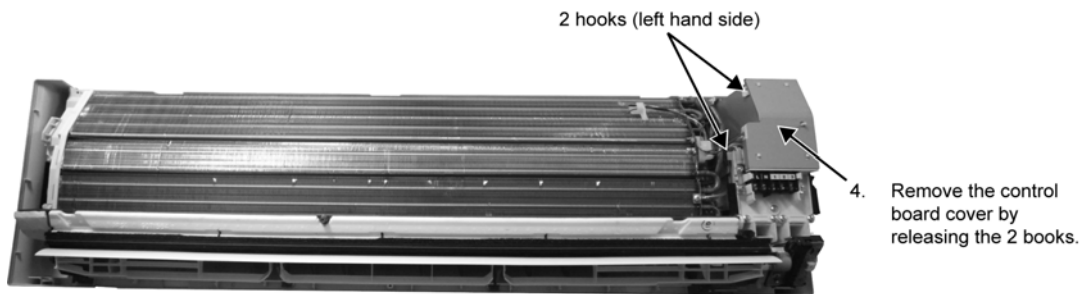

Figure 2

16.1.3 To remove electronic controller

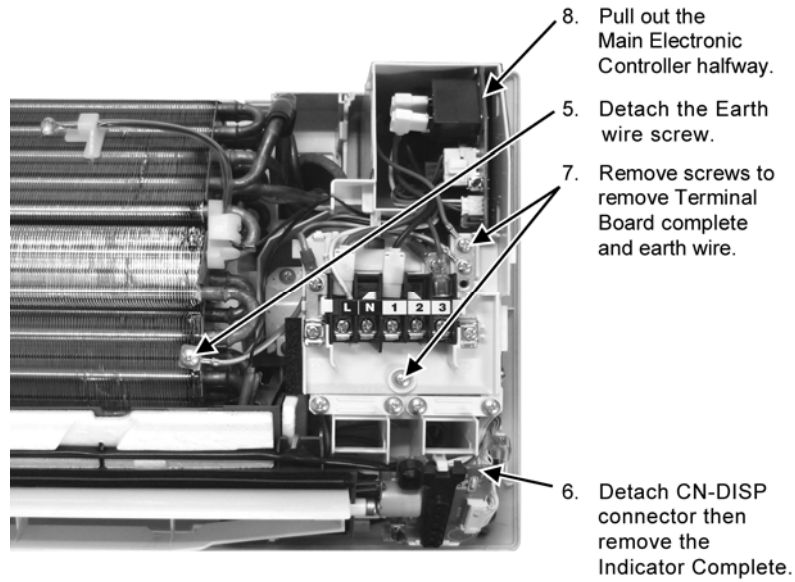

Figure 3

9. Detach AC303 (WHT) wire from PCB, then detach AC306 (BLK) and AC304 (RED) wires from Terminal Board Complete.

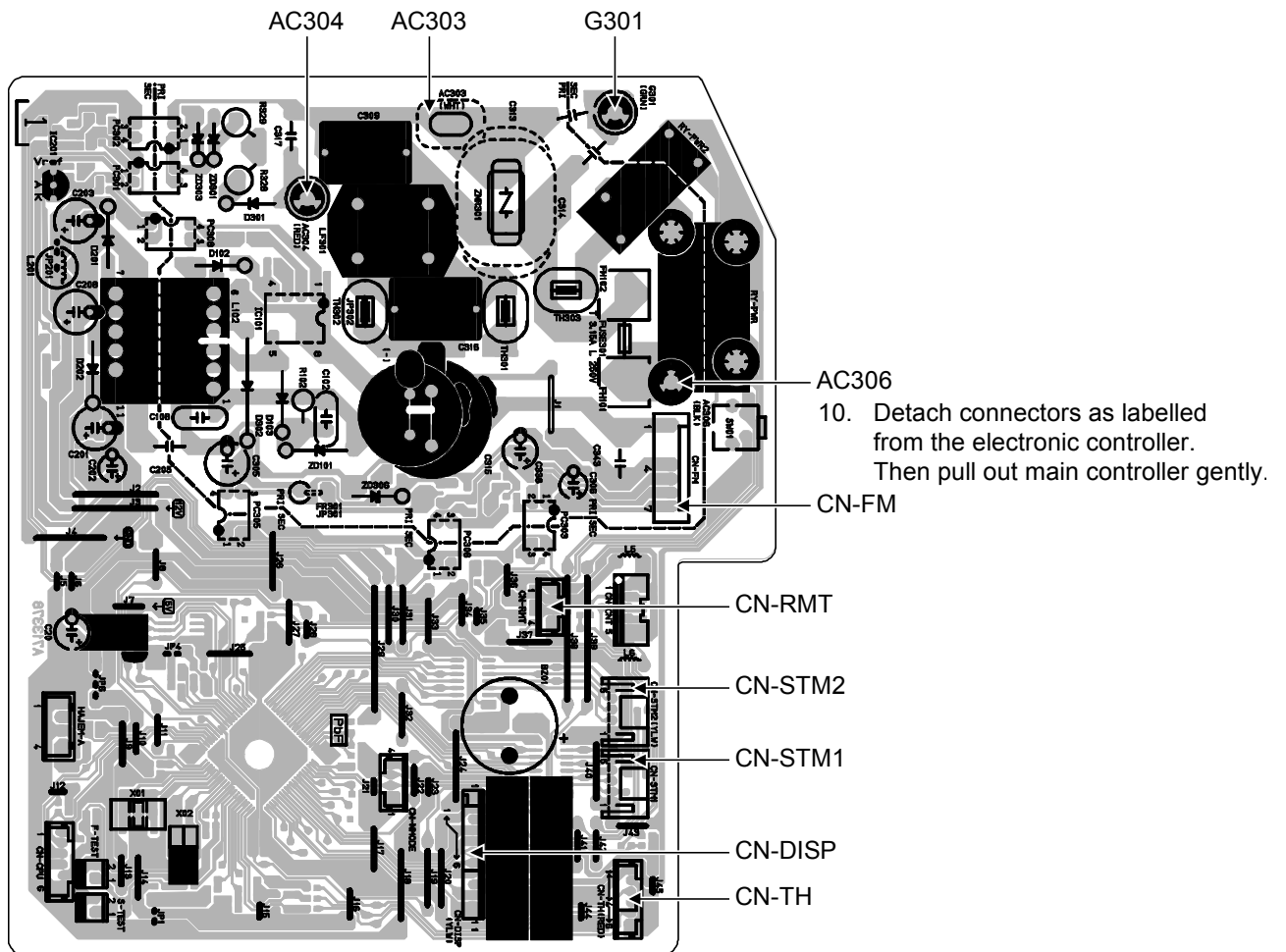

Figure 4

10. Detach connectors as labelled from the electronic controller. Then pull out main controller gently.

16.1.4 To remove discharge grille

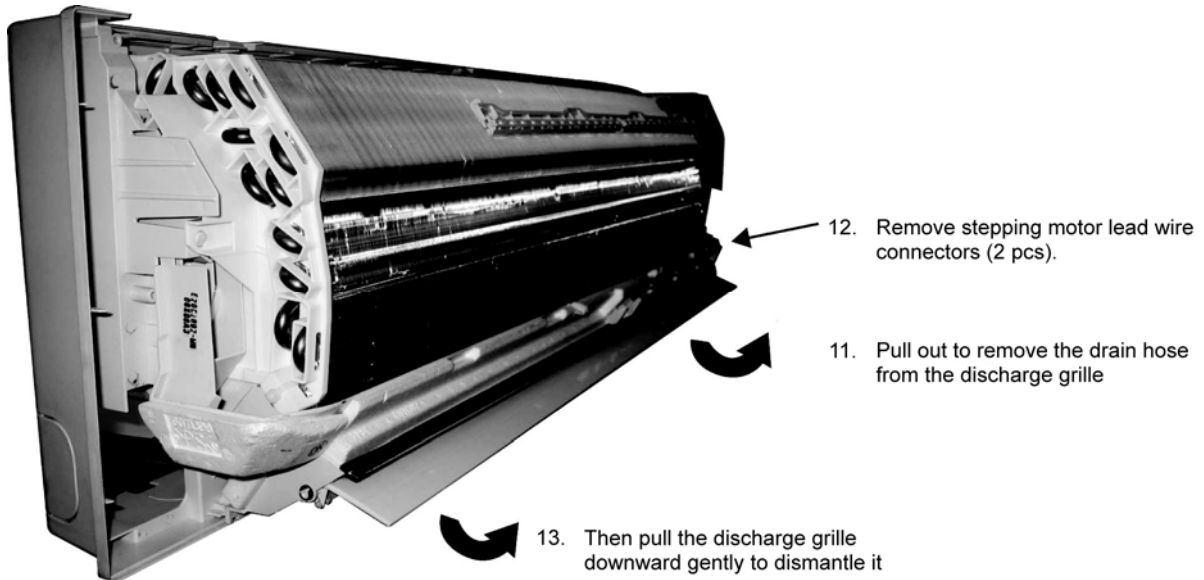

Figure 5

16.1.5 To remove control board

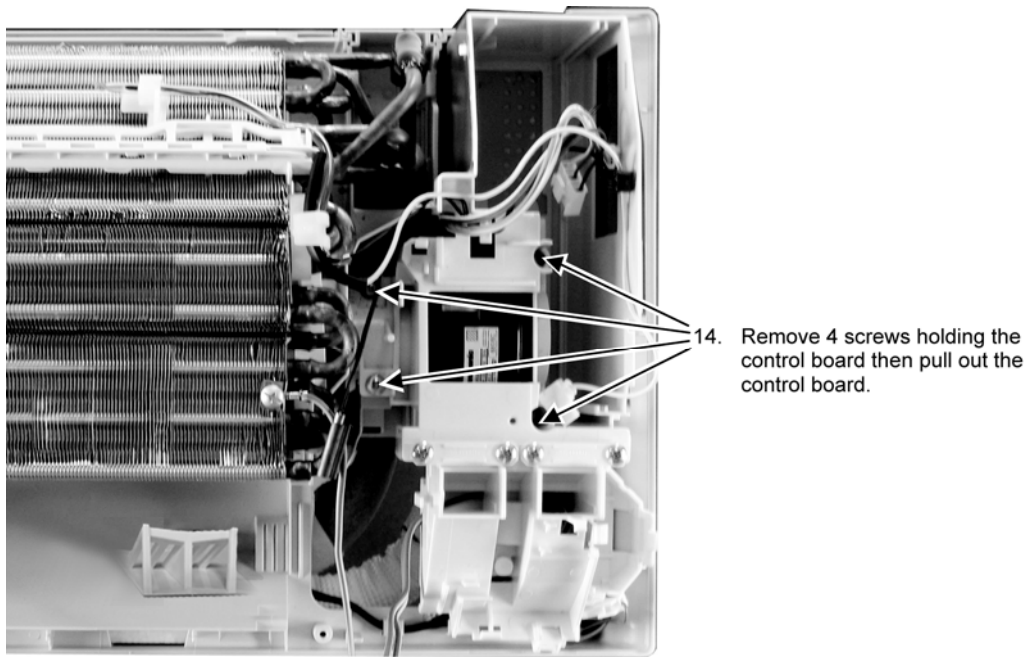

Figure 6

16.1.6 To remove cross flow fan and indoor fan motor

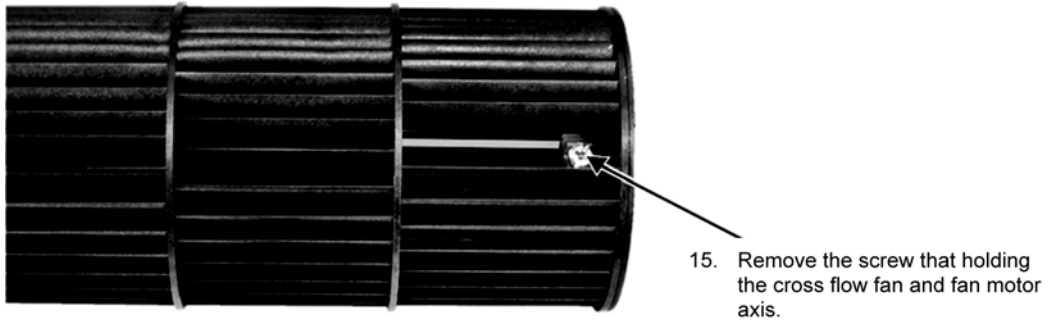

Figure 7

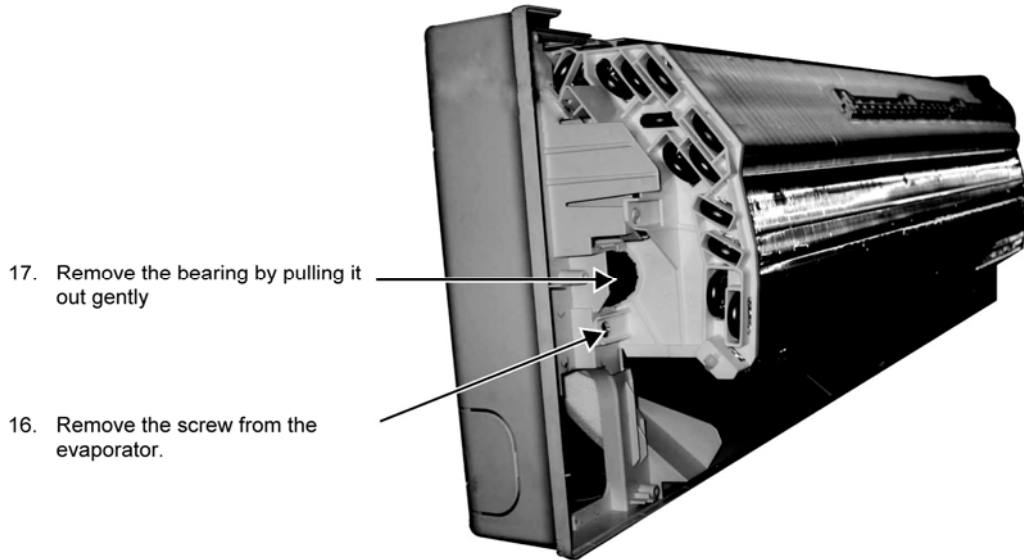
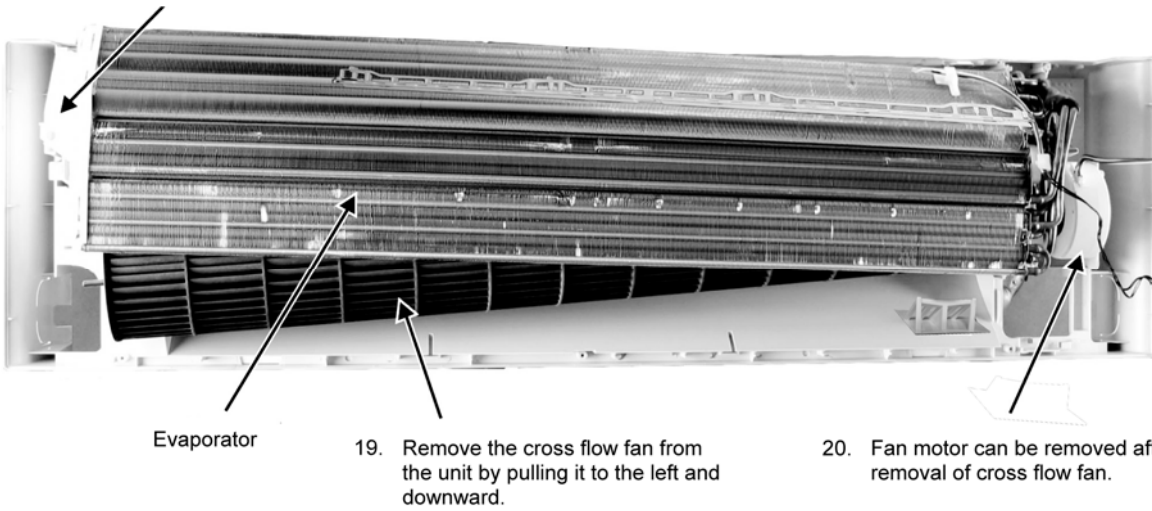

Figure 8

18. Push the holdfast to the left and lift up the evaporator.



Reminder: To reinstall the fan motor, adjust the fan motor connector to 45° towards you before fixing control board.

Figure 9

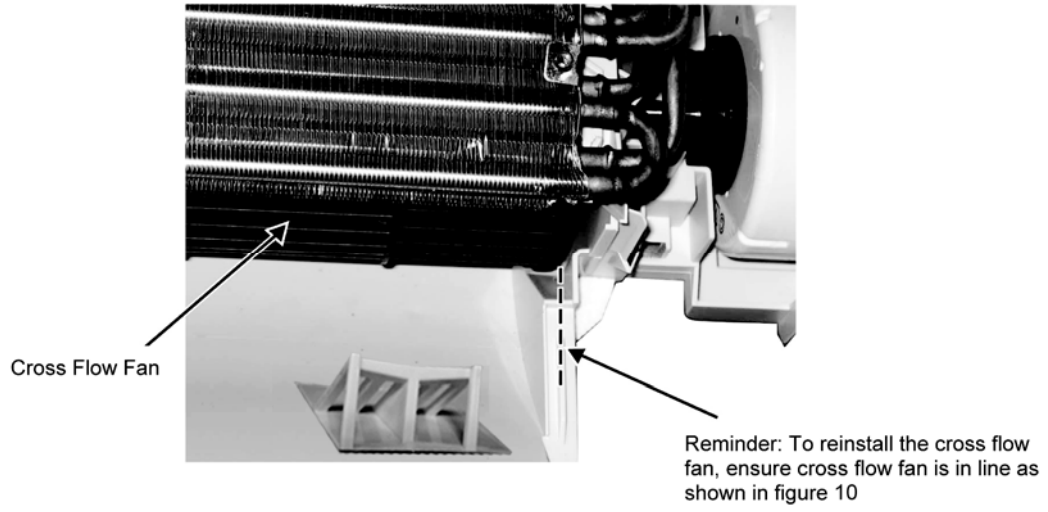

Figure 10

16.2 Outdoor Electronic Controller Removal Procedure

16.2.1 CU-RE18RKE

1 Remove the 8 screws of the Top Panel.

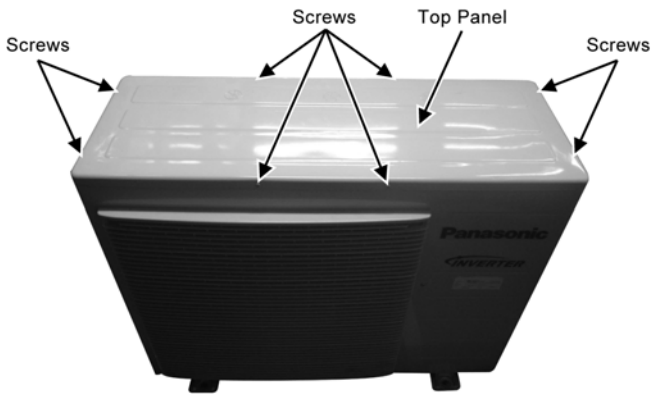

Fig. 1

2 Remove the 8 screws of the Front Panel.

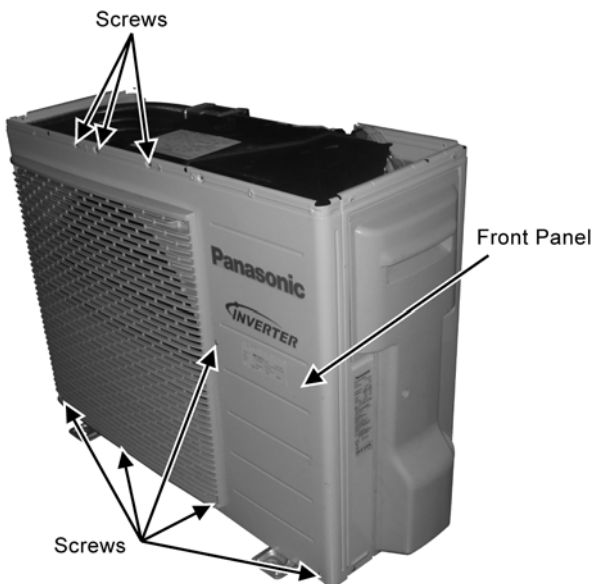

Fig. 2

3 Remove the Top Cover of the Electronic Controller.

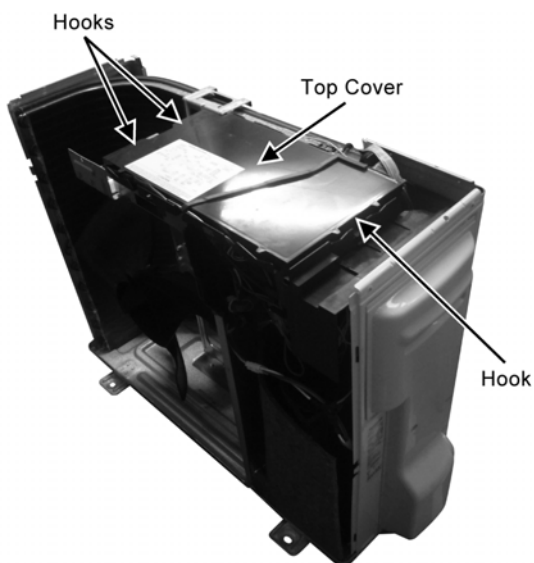

Fig. 3

4 Remove the Control Board.

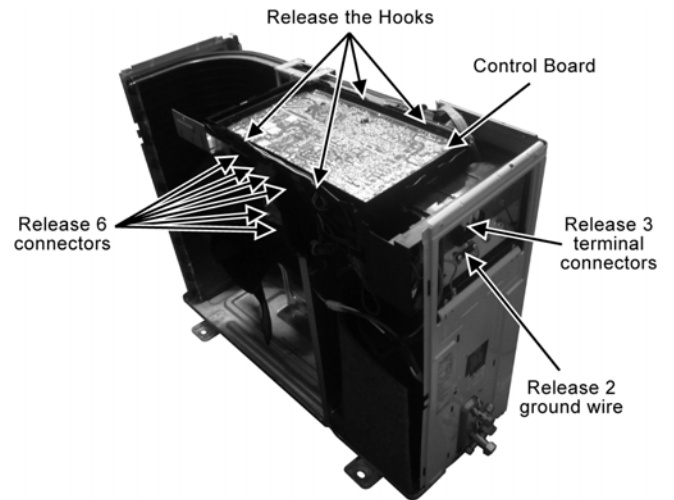

Fig. 4

5 Remove the 6 screws of the Electronic Controller.

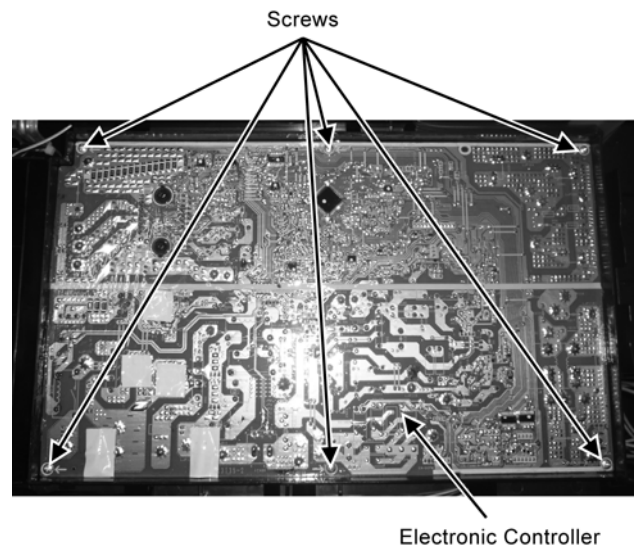

Fig. 5

⚠ Caution! When handling electronic controller, be careful of electrostatic discharge.

16.2.2 CU-RE24RKE

- 1 Remove the 8 screws of the Top Panel.

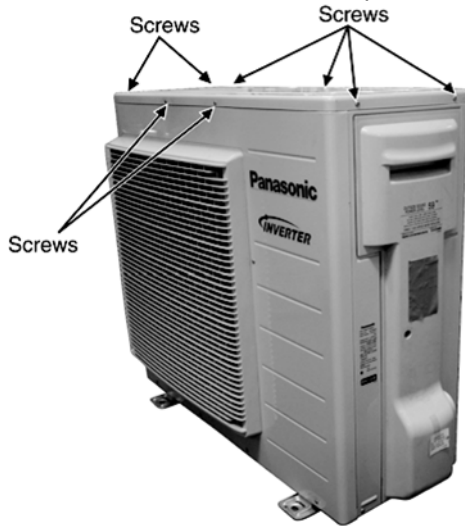

Fig. 1

- 2 Remove the 8 screws of the Front Panel.

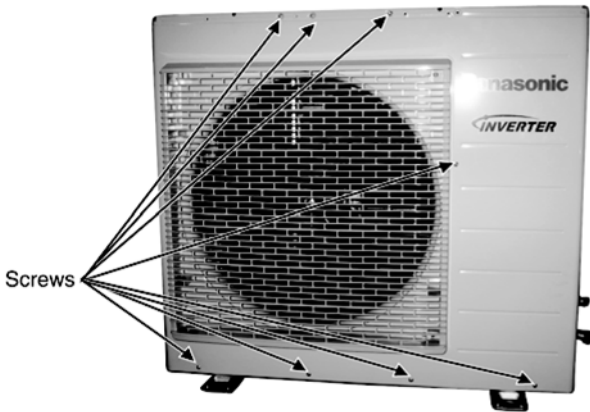

Fig. 2

- 3 Remove the Top Cover of the Electronic Controller.

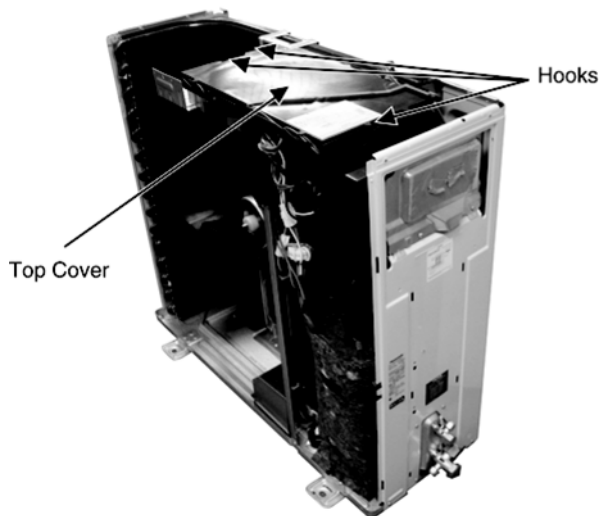

Fig. 3

- 4 Remove the Control Board.

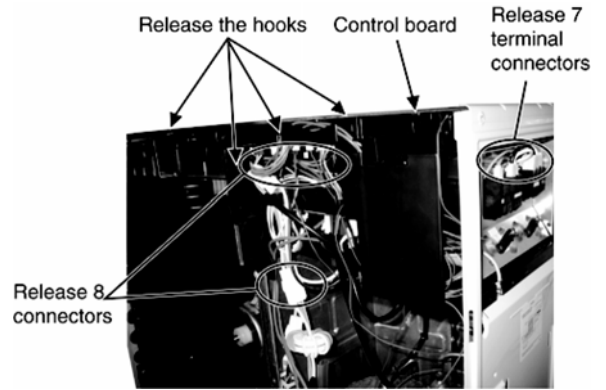

Fig. 4

- 5 Remove the 6 screws of the Electronic Controller.

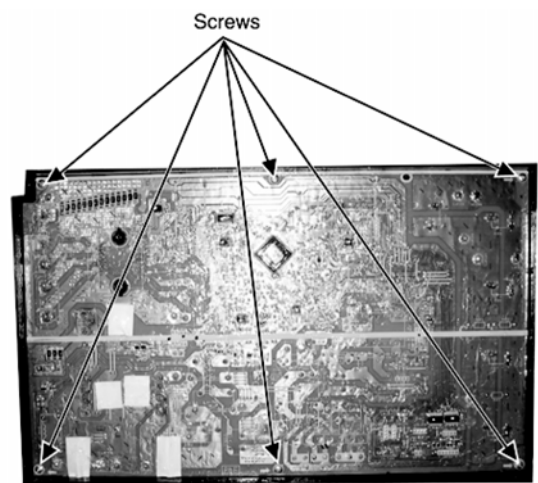

Fig. 5

⚠ Caution! When handling electronic controller, be careful of electrostatic discharge.

17. Technical Data

Technical data provided are based on the air conditioner running under free frequency.

17.1 Cool Mode Performance Data

Unit setting: Standard piping length, Hi Fan, Cool mode at 16°C

Voltage: 230V

CS-RE18RKEW/CU-RE18RKE

Indoor (°C)		Outdoor DB (°C)																				
DB	WB	-10			-7			0			5			16			25			35		
		TC	SHC	IP	TC	SHC	IP	TC	SHC	IP	TC	SHC	IP	TC	SHC	IP	TC	SHC	IP	TC	SHC	IP
27	19.0	5707	4247	1028	5959	4347	938	5528	4194	1106	5716	4252	1019	5620	4252	1013	5229	4019	1273	5000	4090	1470
	22.0	6546	3471	898	6270	3315	1014	6053	3294	1155	5853	3202	1071	6062	3382	1016	5686	3181	1287	5242	2427	1489
23	15.7	5022	4052	1134	5066	4112	1135	5179	4083	1047	5119	4072	1079	5211	4094	1013	4838	3933	1249	4347	3743	1441
	18.4	5614	3267	1038	5379	3186	1143	6068	3418	911	5532	3101	1126	5688	3231	1015	5318	3061	1262	4785	2882	1467
20	13.3	4421	3841	1125	4205	3716	1242	4260	3730	829	4258	3749	921	4556	3896	848	4531	3891	1248	4008	3600	1433
	15.8	4409	2880	1299	4679	2979	1176	4482	2888	862	5023	3197	791	6087	3594	1018	5430	3331	1260	4477	2859	1448

(Dry bulb value based on 46% humidity)

CS-RE24RKEW / CU-RE24RKE

Indoor (°C)		Outdoor DB (°C)																				
DB	WB	-10			-7			0			5			16			25			35		
		TC	SHC	IP	TC	SHC	IP	TC	SHC	IP	TC	SHC	IP	TC	SHC	IP	TC	SHC	IP	TC	SHC	IP
27	19.0	7761	5393	1468	8105	5520	1340	7519	5325	1580	7774	5399	1455	7644	5399	1447	7112	5104	1818	6800	5193	2100
	22.0	8903	4408	1283	8528	4210	1448	8232	4183	1649	7961	4066	1529	8244	4294	1451	7733	4039	1838	7129	3082	2128
23	15.7	6830	5145	1620	6889	5222	1622	7043	5185	1495	6961	5171	1541	7088	5198	1447	6580	4995	1784	5912	4754	2058
	18.4	7636	4149	1483	7316	4046	1633	8252	4340	1301	7523	3937	1609	7736	4102	1450	7233	3888	1803	6508	3660	2096
20	13.3	6012	4877	1607	5719	4719	1774	5794	4736	1184	5790	4761	1315	6196	4947	1211	6163	4942	1783	5451	4572	2048
	15.8	5997	3657	1855	6364	3783	1680	6096	3667	1231	6831	4060	1129	8279	4564	1454	7385	4230	1800	6089	3630	2068

(Dry bulb value based on 46% humidity)

17.2 Heat Mode Performance Data

Unit setting: Standard piping length, Hi Fan, Heat mode at 30°C
Voltage: 230V

17.2.1 CS-RE18RKEW/CU-RE18RKE

Indoor (°C)	Outdoor WB (°C)									
DB	-15		-7		2		7		12	
	TC	IP	TC	IP	TC	IP	TC	IP	TC	IP
24	3808	2034	4717	2505	5431	2452	5368	1628	5908	1735
20	3920	1960	4980	2410	5800	2350	5800	1540	6143	1665
16	3660	1873	4772	2304	5569	2251	5647	1456	6308	1576

17.2.2 CS-RE24RKEW/CU-RE24RKE

Indoor (°C)	Outdoor WB (°C)									
DB	-15		-7		2		7		12	
	TC	IP	TC	IP	TC	IP	TC	IP	TC	IP
24	4575	2431	5806	2858	6714	2890	7959	2759	8760	2940
20	4710	2343	6130	2750	7170	2770	8600	2610	9109	2822
16	4398	2239	5874	2629	6885	2653	8373	2467	9353	2672

TC - Total Cooling Capacity (kW)
SHC - Sensible Heat Capacity (kW)
IP - Input Power (kW)

18. Service Data

Service data provided are based on the air conditioner running under rated frequency during forced cooling / forced heating mode.

18.1 Cool Mode Outdoor Air Temperature Characteristic

Condition

- Indoor room temperature: 27°C DryBulb/19°C Wet Bulb
- Unit setting: Standard piping length, forced cooling at 16°C, Hi fan
- Compressor frequency: Rated for cooling operation
- Voltage: 230V

18.1.1 CS-RE18RKEW CU-RE18RKE

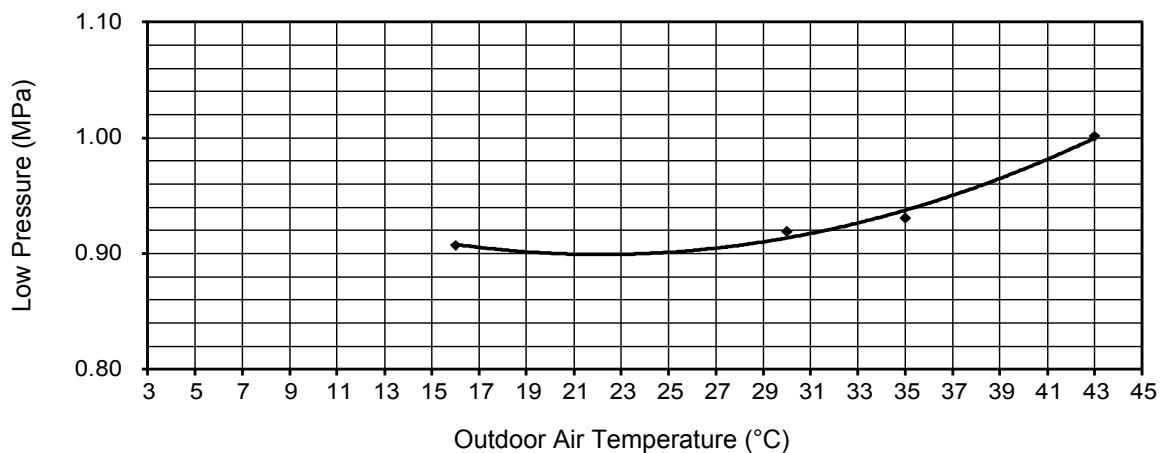
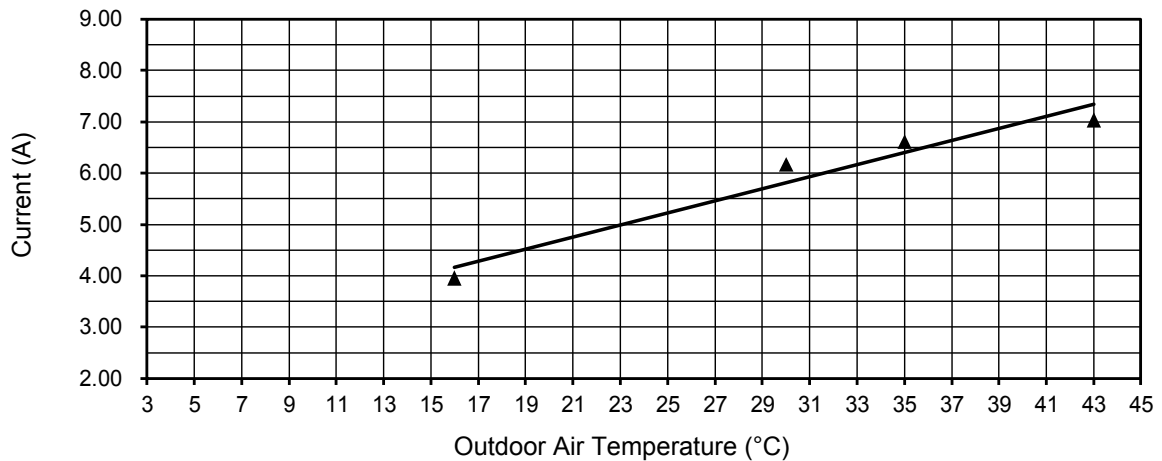
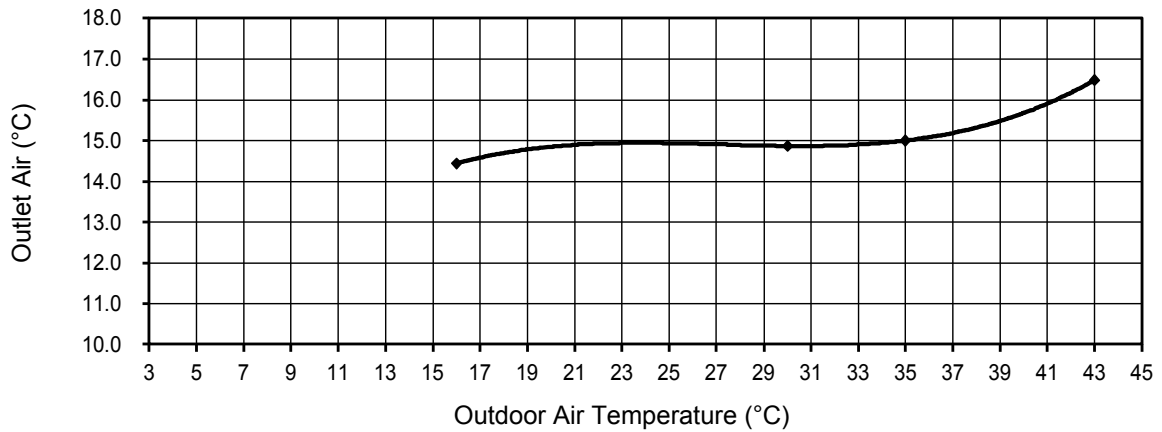

18.1.2 CS-RE24RKEW CU-RE24RKE

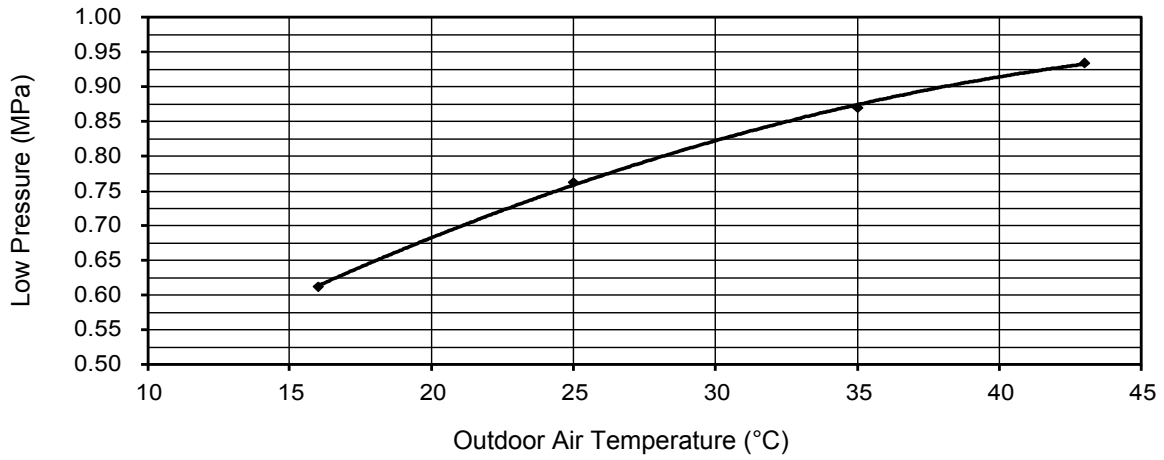
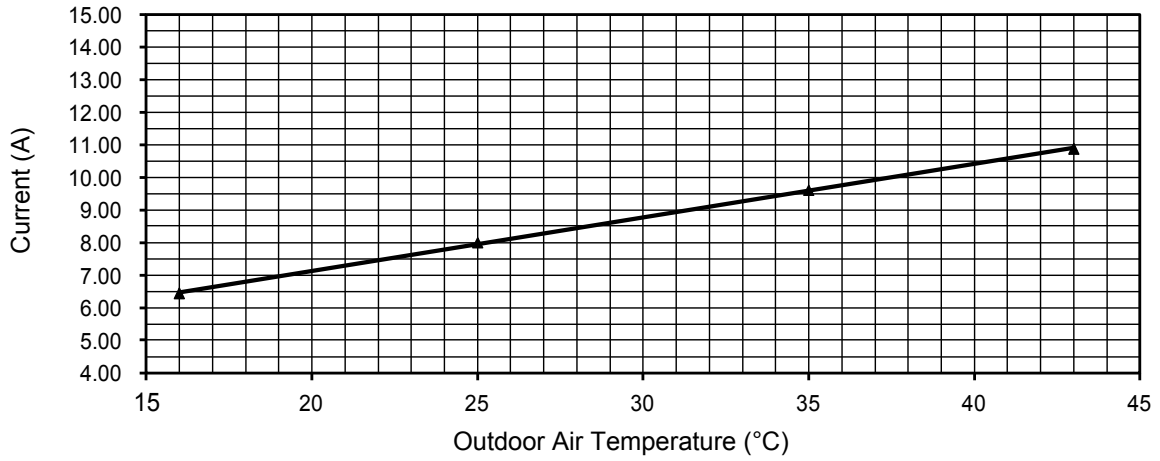
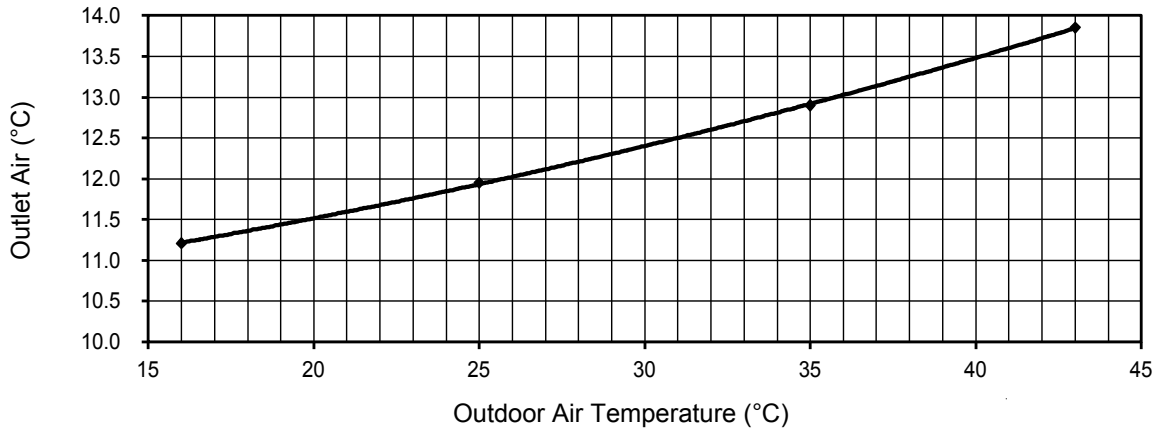

18.2 Heat Mode Outdoor Air Temperature Characteristic

Condition

- Indoor room temperature: 20°C DryBulb/ -°C Wet Bulb
- Unit setting: Standard piping length, forced heating at 30°C, Hi fan
- Compressor frequency: Rated for Heating operation
- Voltage: 230V

18.2.1 CS-RE18RKEW CU-RE18RKE

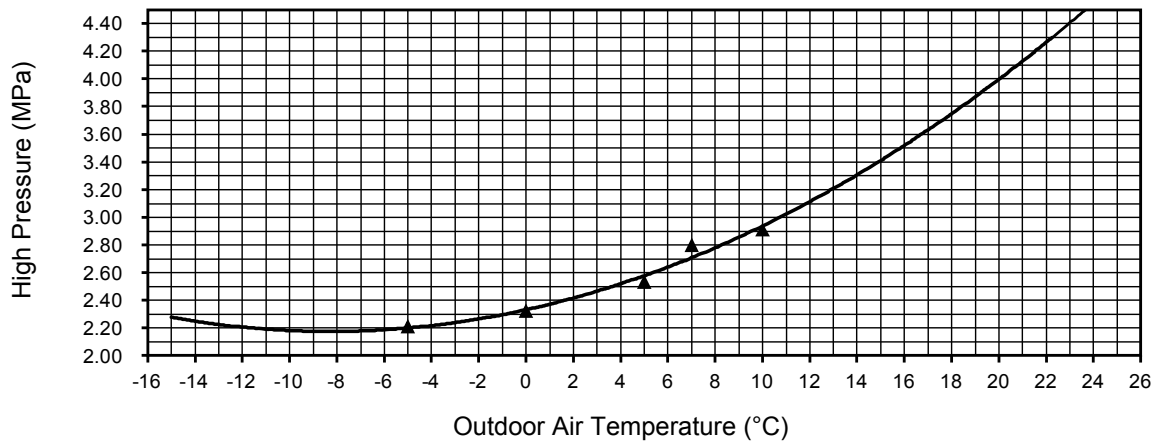
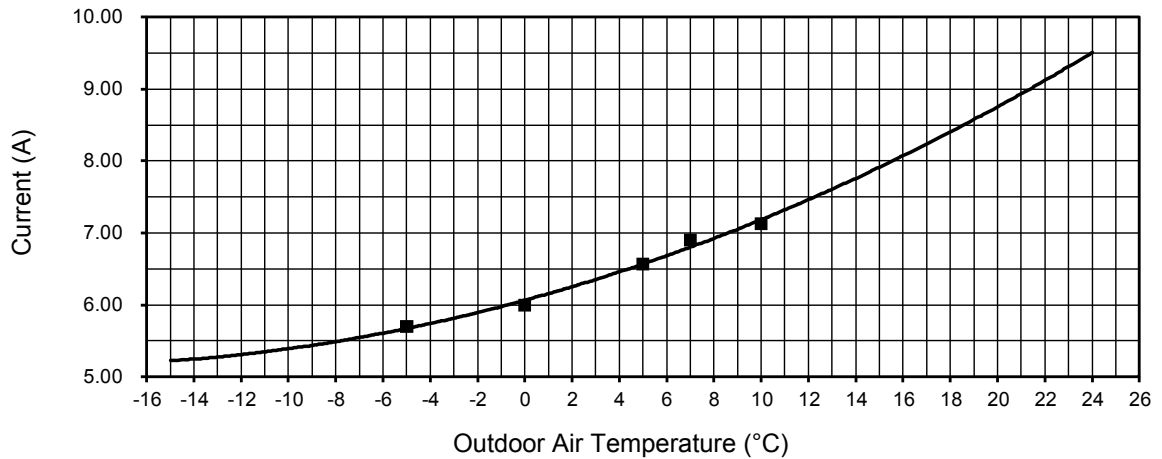
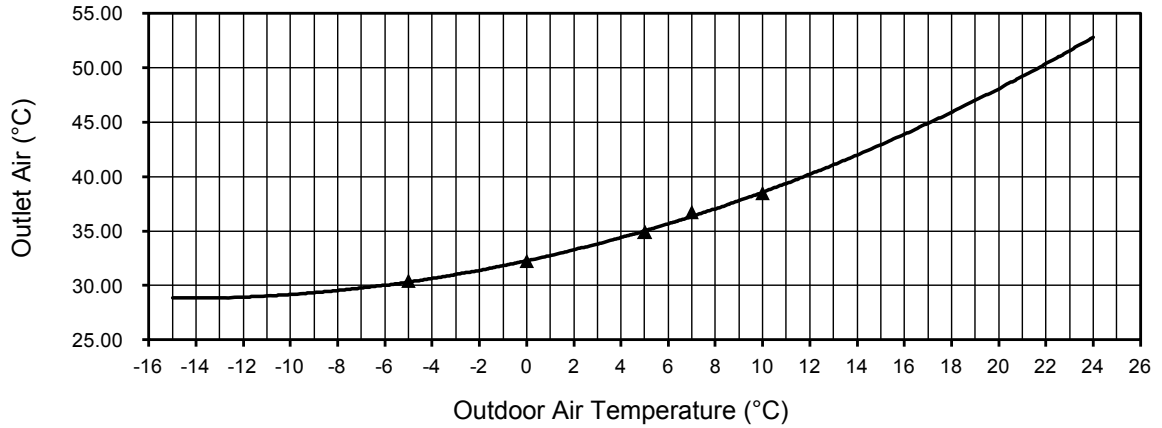

18.2.2 CS-RE24RKEW CU-RE24RKE

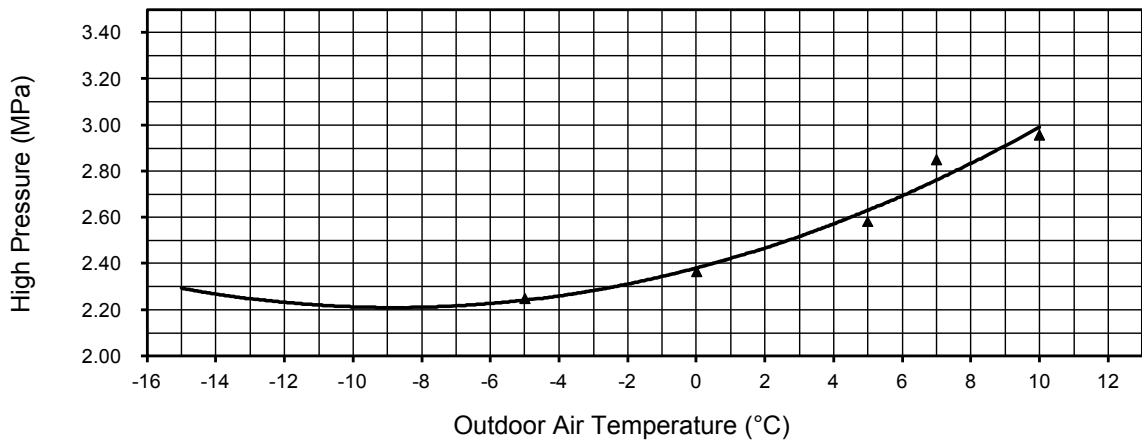
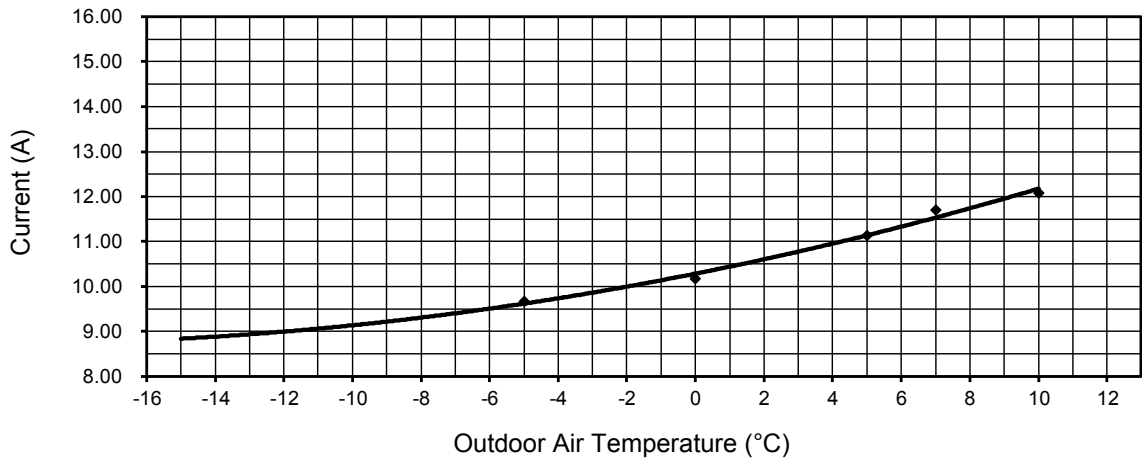
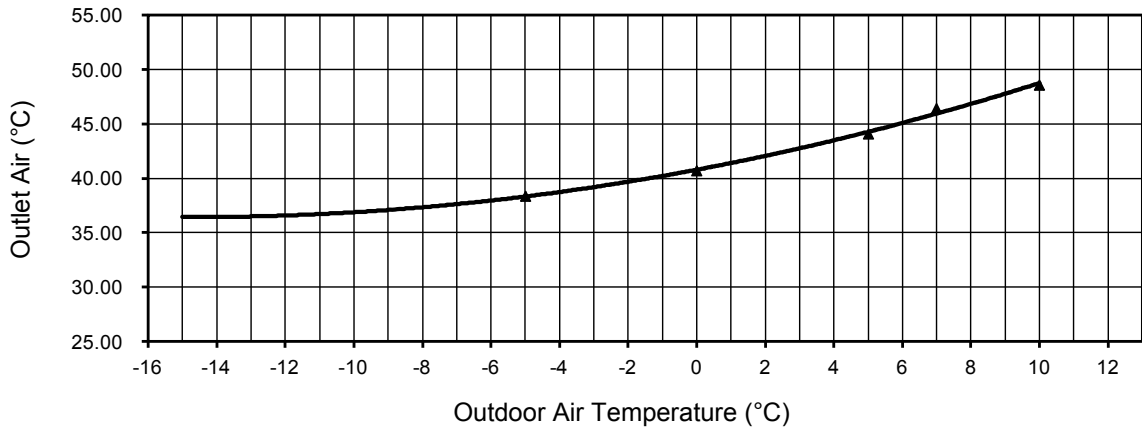

18.3 Piping Length Correction Factor

The characteristic of the unit has to be corrected in accordance with the piping length.

18.3.1 CS-RE18RKEW CU-RE18RKE CS-RE24RKEW CU-RE24RKE

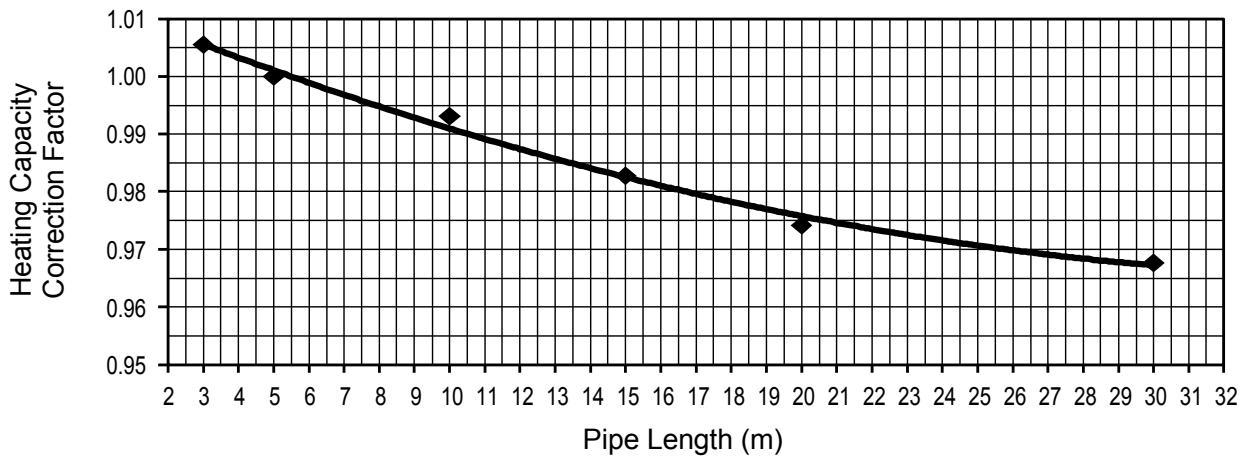
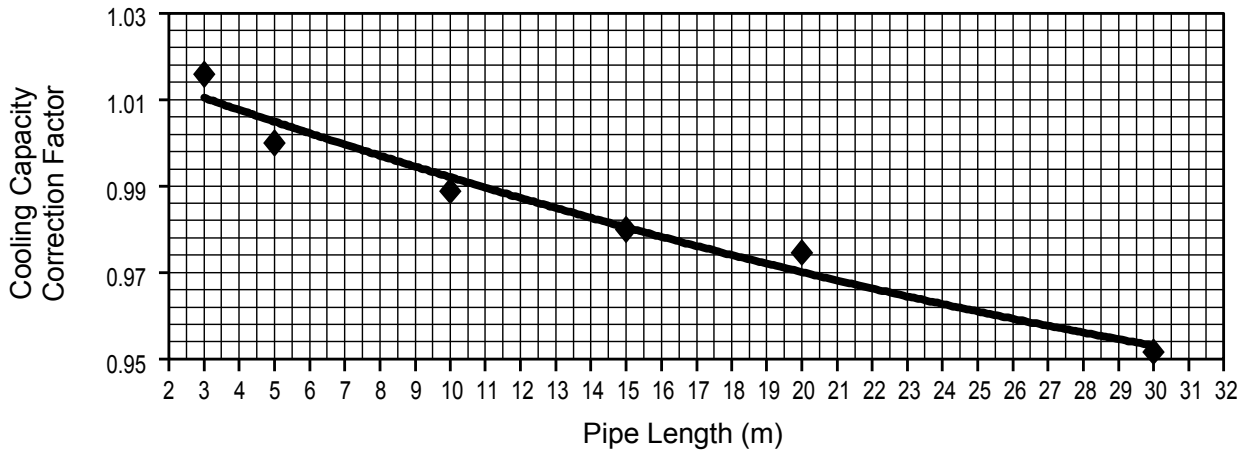

Note: The graphs show the factor after added right amount of additional refrigerant.

19. Exploded View and Replacement Parts List

19.1 Indoor Unit

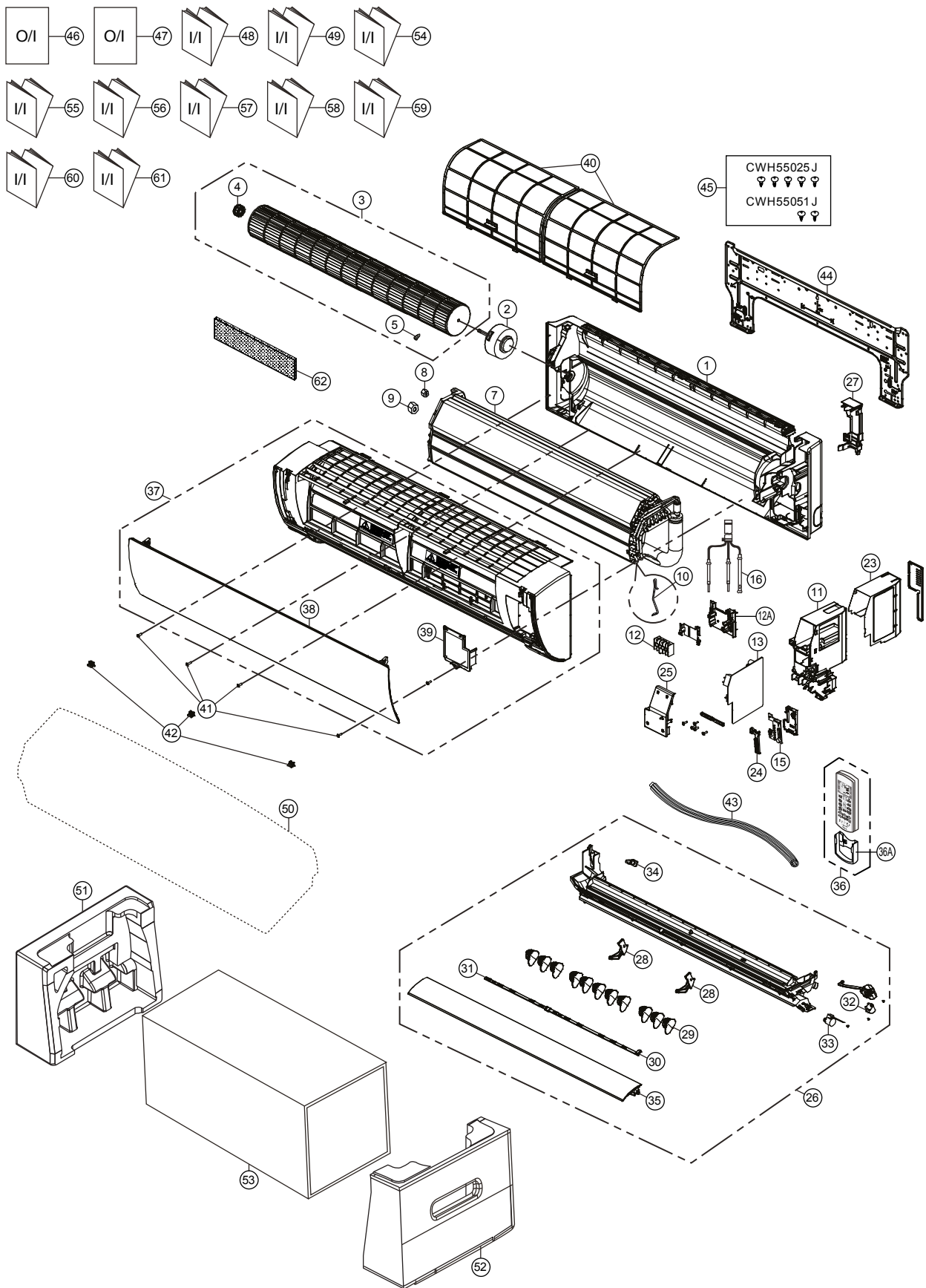

Note:
The above exploded view is for the purpose of parts disassembly and replacement.
The non-numbered parts are not kept as standard service parts.

<Model: CS-RE18RKEW CS-RE24RKEW

SAFETY	REF. NO.	PART NAME & DESCRIPTION	QTY.	CS-RE18RKEW	CS-RE24RKEW	REMARK
	1	CHASSIS COMPLETE	1	CWD50C1654	←	
	2	FAN MOTOR	1	ARW7627AC	←	O
	3	CROSS-FLOW FAN COMPLETE	1	CWH02C1077	←	
	4	BEARING ASSY	1	CWH64K007	←	O
	5	SCREW - CROSS-FLOW FAN	1	CWH551146	←	
	7	EVAPORATOR	1	CWB30C4396	CWB30C4424	
	8	FLARE NUT (LIQUID)	1	CWT251030	←	
	9	FLARE NUT (GAS)	1	CWT251032	CWT251033	
	10	CLIP FOR SENSOR	1	CWH32143	←	
	11	CONTROL BOARD CASING	1	CWH102449	←	
	12	TERMINAL BOARD COMPLETE	1	CWA28C2305	←	O
	12A	PARTICULAR PIECE - TERMINAL	1	CWD933137	←	
	13	ELECTRONIC CONTROLLER - MAIN	1	CWA73C9078	CWA73C9079	O
	15	ELECTRONIC CONTROLLER - INDICATOR	1	CWA747149	←	O
	16	SENSOR COMPLETE	1	CWA50C2663	←	O
	23	CONTROL BOARD TOP COVER	1	CWH131467	←	
	24	INDICATOR HOLDER	1	CWD933406	←	
	25	CONTROL BOARD FRONT COVER CO.	1	CWH13C1247	←	
	26	DISCHARGE GRILLE COMPLETE	1	CWE20C3242	←	
	27	BACK COVER CHASSIS	1	CWD933031	←	
	28	FULCRUM	2	CWH621138	←	
	29	VERTICAL VANE	11	CWE241374	←	
	30	CONNECTING BAR	1	CWE261257	←	
	31	CONNECTING BAR	1	CWE261258	←	
	32	AIR SWING MOTOR ASSY	1	CWA98K1018	←	O
	33	AIR SWING MOTOR	1	CWA981241	←	O
	34	CAP - DRAIN TRAY	1	CWH521259	←	
	35	HORIZONTAL VANE COMPLETE	1	CWE24C1392	←	
	36	REMOTE CONTROL COMPLETE	1	CWA75C4571	←	O
	36A	REMOTE CONTROL HOLDER	1	CWH361078	←	
	37	FRONT GRILLE COMPLETE	1	CWE11C6004	CWE11C6005	O
	38	INTAKE GRILLE COMPLETE	1	CWE22C1897	←	
	39	GRILLE DOOR COMPLETE	1	CWE14C1090	←	
	40	AIR FILTER	2	CWD001283	←	O
	41	SCREW - FRONT GRILLE	4	XTT4+16CFJ	←	
	42	CAP - FRONT GRILLE	3	CWH521227	←	
	43	DRAIN HOSE	1	CWH851173	←	
	44	INSTALLATION PLATE	1	CWH361098	←	
	45	BAG COMPLETE - INSTALLATION SCREW	1	CWH82C1705	←	
	46	OPERATING INSTRUCTION	1	CWF569892	←	
	47	OPERATING INSTRUCTION	1	CWF569893	←	
	48	INSTALLATION INSTRUCTION	1	CWF616688	←	
	49	INSTALLATION INSTRUCTION	1	CWF616689	←	
	50	BAG	1	CWG861498	←	
	51	SHOCK ABSORBER (L)	1	CWG713402	←	
	52	SHOCK ABSORBER (R)	1	CWG713403	←	
	53	C.C.CASE	1	CWG567455	CWG567454	
	54	INSTALLATION INSTRUCTION	1	CWF616690	←	

SAFETY	REF. NO.	PART NAME & DESCRIPTION	QTY.	CS-RE18RKEW	CS-RE24RKEW	REMARK
	55	INSTALLATION INSTRUCTION	1	CWF616691	←	
	56	INSTALLATION INSTRUCTION	1	CWF616692	←	
	57	INSTALLATION INSTRUCTION	1	CWF616693	←	
	58	INSTALLATION INSTRUCTION	1	CWF616694	←	
	59	INSTALLATION INSTRUCTION	1	CWF616695	←	
	60	INSTALLATION INSTRUCTION	1	CWF616696	←	
	61	INSTALLATION INSTRUCTION	1	CWF616697	←	
	62	AIR PURIFYING FILTER	1	CWD00C1291	←	

(Note)

- All parts are supplied from PAPAMY, Malaysia (Vendor Code: 00029488).
- "O" marked parts are recommended to be kept in stock.

19.2 Outdoor Unit

19.2.1 CU-RE18RKE

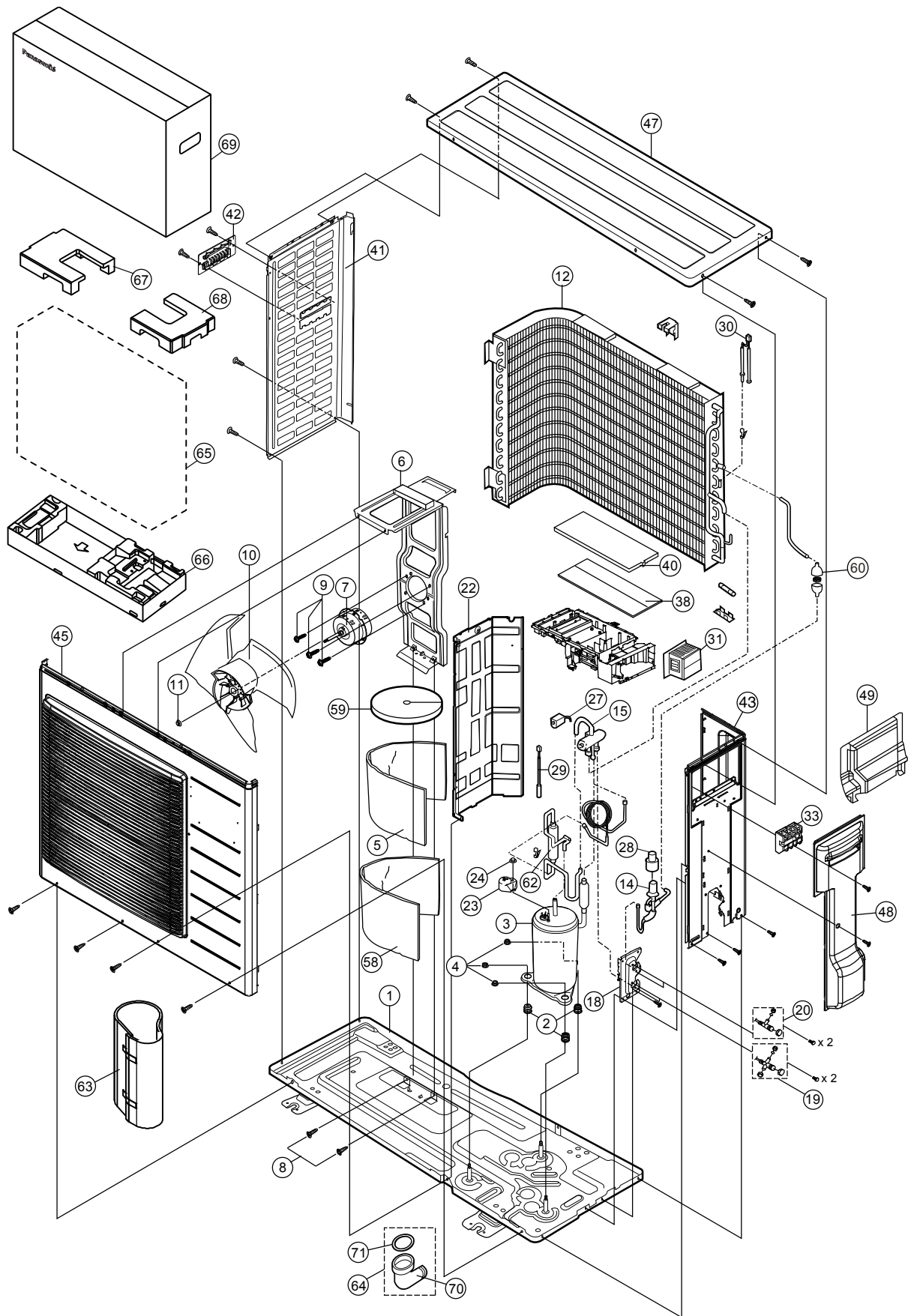

Note:
The above exploded view is for the purpose of parts disassembly and replacement.
The non-numbered parts are not kept as standard service part.

SAFETY	REF. NO.	PART NAME & DESCRIPTION	QTY.	CU-RE18RKE	REMARK
	1	CHASSIS ASSY	1	CWD52K1261	
	2	ANTI - VIBRATION BUSHING	3	CWH50077	
⚠	3	COMPRESSOR	1	5RD132XBA21	O
	4	NUT - COMPRESSOR MOUNT	3	CWH561096	
	5	SOUND PROOF MATERIAL	1	CWG302632	
	6	FAN MOTOR BRACKET	1	CWD541153	
⚠	7	FAN MOTOR	1	ARW8401AC	O
	8	SCREW - FAN MOTOR BRACKET	2	CWH551217	
	9	SCREW - FAN MOTOR MOUNT	4	CWH551106J	
	10	PROPELLER FAN ASSY	1	CWH03K1065	
	11	NUT - PROPELLER FAN	1	CWH56053J	
	12	CONDENSER	1	CWB32C4137	
	14	EXPANSION VALVE	1	CWB051016J	
	15	4-WAYS VALVE	1	CWB001026J	O
	18	HOLDER COUPLING	1	CWH351227	
	19	3-WAY VALVE (GAS)	1	CWB011361	O
	20	2-WAYS VALVE (LIQUID)	1	CWB021292	O
	22	SOUND PROOF BOARD	1	CWH151257	
	23	TERMINAL COVER	1	CWH171039A	
	24	NUT - TERMINAL COVER	1	CWH7080300J	
⚠	27	V-COIL COMPLETE (FOR 4 WAY VALVE)	1	CWA43C2169J	O
⚠	28	V-COIL COMPLETE (FOR EXPANSION VALVE)	1	CWA43C2257	O
	29	SENSOR CO - COMP. TEMP	1	CWA50C2185	O
	30	SENSOR - COMPLETE	1	CWA50C2517	O
⚠	31	REACTOR	1	G0C203J00003	O
⚠	33	TERMINAL BOARD ASSY	1	CWA28K1110J	O
⚠	38	ELECTRONIC CONTROLLER - MAIN	1	CWA73C9096R	O
	40	CONTROL BOARD COVER - TOP	1	CWH131333	
	41	CABINET SIDE PLATE CO. (LEFT)	1	CWE041560A	
	42	HANDLE	1	CWE161010	
	43	CABINET SIDE PLATE (RIGHT)	1	CWE041798A	
	45	CABINET FRONT PLATE CO.	1	CWE06K1077	
	47	CABINET TOP PLATE	1	CWE031083A	
	48	CONTROL BOARD COVER - COMPLETE	1	CWH13C1238	
	49	CONTROL BOARD COVER	1	CWH131409A	
	58	SOUND PROOF MATERIAL	1	CWG302636	
	59	SOUND PROOF MATERIAL	1	CWG302630	
	60	STRAINER	1	CWB11094	
	62	RECEIVER	1	CWB14011	
	63	SOUND PROOF MATERIAL	1	CWG302950	
	64	BAG - COMPLETE	1	CWG87C900	
	65	BAG	1	CWG861461	
	66	BASE BOARD - COMPLETE	1	CWG62C1131	
	67	SHOCK ABSORBER (LEFT)	1	CWG713217	
	68	SHOCK ABSORBER (RIGHT)	1	CWG713218	
	69	C.C.CASE	1	CWG568360	

SAFETY	REF. NO.	PART NAME & DESCRIPTION	QTY.	CU-RE18RKE	REMARK
	70	FLEXIBLE PIPE (L-TUBE)	1	CWH5850080	
	71	PACKING - L.TUBE	1	CWB81012	

(Note)

- All parts are supplied from PAPAMY, Malaysia (Vendor Code: 00029488).
- “O” marked parts are recommended to be kept in stock.

19.2.2 CU-RE24RKE

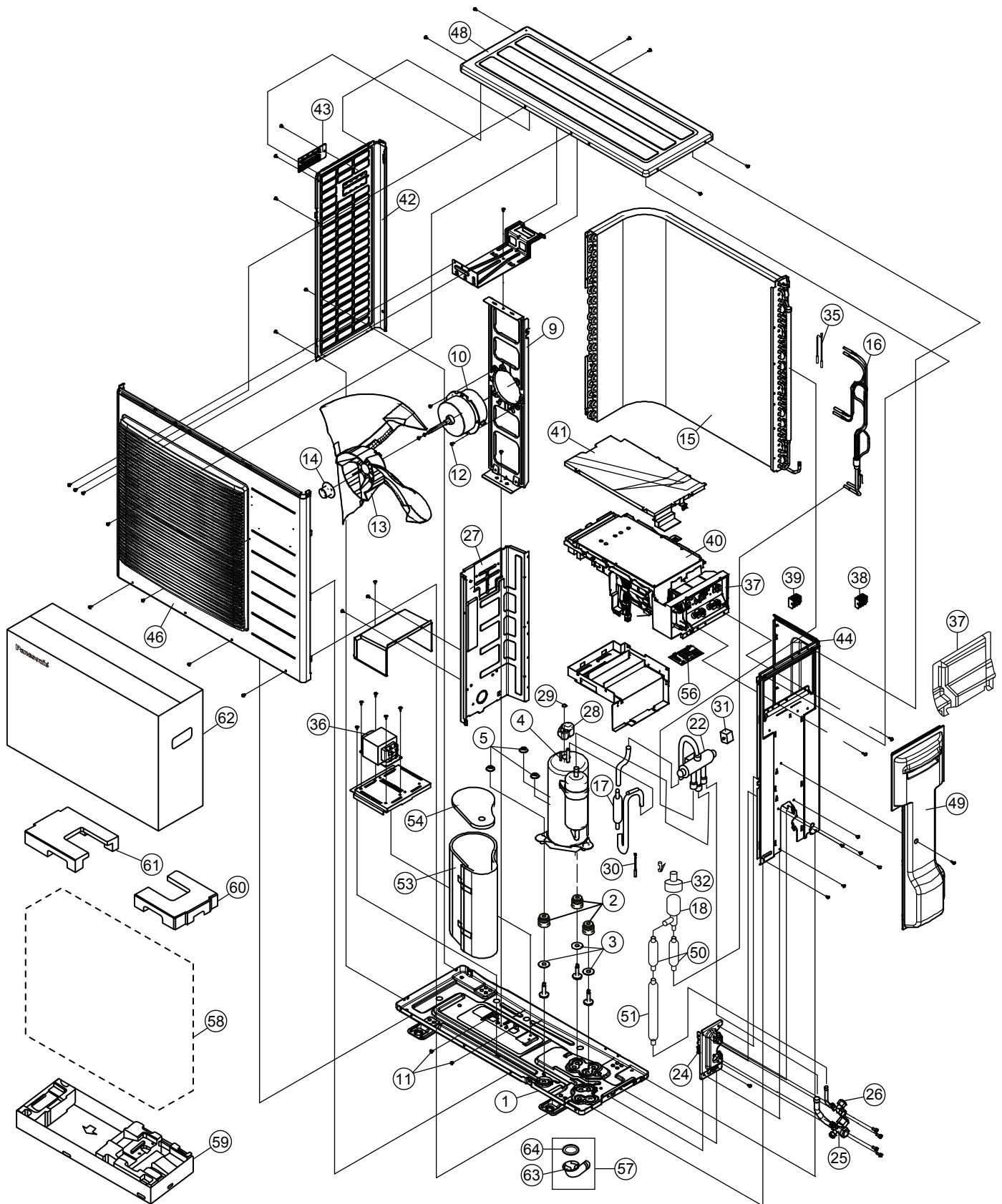

Note:
The above exploded view is for the purpose of parts disassembly and replacement.
The non-numbered parts are not kept as standard service part.

SAFETY	REF. NO.	PART NAME & DESCRIPTION	QTY.	CU-RE24RKE	REMARK
	1	CHASSIS ASSY	1	CWD52K1190	
	2	ANTI - VIBRATION BUSHING	3	CWH50055	
	3	PACKING	3	CWB81043	
⚠	4	COMPRESSOR	1	5KD240XAF21	O
	5	NUT - COMPRESSOR MOUNT	3	CWH561049	
	9	FAN MOTOR BRACKET	1	CWD541127	
⚠	10	FAN MOTOR	1	EHDS83JAC	O
	11	SCREW - FAN MOTOR BRACKET	2	CWH551217	
	12	SCREW - FAN MOTOR MOUNT	4	CWH551323	
	13	PROPELLER FAN ASSY	1	CWH00K1006	
	14	NUT - PROPELLER FAN	1	CWH561092	
	15	CONDENSER	1	CWB32C3706	
	16	TUBE ASSY CO.(CAP TUBE)	1	CWT01C5849	
	17	DISCHARGE MUFFLER	1	CWB121013	
	18	EXPANSION VALVE	1	CWB051018J	
	22	4-WAYS VALVE	1	CWB001026J	O
	24	HOLDER COUPLING	1	CWH351228	
	25	3-WAY VALVE (GAS)	1	CWB011363	O
	26	2-WAYS VALVE (LIQUID)	1	CWB021434	O
	27	SOUND PROOF BOARD	1	CWH151197	
	28	TERMINAL COVER	1	CWH171039A	
	29	NUT - TERMINAL COVER	1	CWH7080300J	
	30	SENSOR CO - COMP. TEMP	1	CWA50C2185	O
⚠	31	V-COIL COMPLETE (FOR 4 WAY VALVE)	1	CWA43C2169J	O
⚠	32	V-COIL COMPLETE (FOR EXPANSION VALVE)	1	CWA43C2258	O
	35	SENSOR - COMPLETE	1	CWA50C2517	O
⚠	36	REACTOR	2	G0C403J00001	O
	37	CONTROL BOARD COVER	1	CWH131332	
⚠	38	TERMINAL BOARD ASSY	1	CWA28K1076J	O
⚠	39	TERMINAL BOARD ASSY	1	CWA28K1162	O
⚠	40	ELECTRONIC CONTROLLER - MAIN	1	CWA73C9095R	O
	41	CONTROL BOARD COVER - TOP	1	CWH131333	
	42	CABINET SIDE PLATE CO. (LEFT)	1	CWE041585A	
	43	HANDLE	1	CWE161010	
	44	CABINET SIDE PLATE (RIGHT)	1	CWE041799A	
	46	CABINET FRONT PLATE CO.	1	CWE06K1063	
	48	CABINET TOP PLATE	1	CWE031083A	
	49	CONTROL BOARD COVER - COMPLETE	1	CWH13C1185	
	50	STRAINER	2	CWB111032	
	51	RECEIVER	1	CWB14017	
	53	SOUND PROOF MATERIAL	1	CWG302951	
	54	SOUND PROOF MATERIAL	1	CWG302246	
⚠	56	ELECTRONIC CONTROLLER - NF	1	CWA748207	O
	57	BAG - COMPLETE	1	CWG87C900	
	58	BAG	1	CWG861154	
	59	BASE BOARD-COMplete	1	CWG62C1081	
	60	SHOCK ABSORBER (RIGHT)	1	CWG712879	
	61	SHOCK ABSORBER (LEFT)	1	CWG712880	
	62	C.C.CASE	1	CWG568361	

SAFETY	REF. NO.	PART NAME & DESCRIPTION	QTY.	CU-RE24RKE	REMARK
	63	FLEXIBLE PIPE (L-TUBE)	1	CWH5850080	
	64	PACKING - L.TUBE	1	CWB81012	

(Note)

- All parts are supplied from PAPAMY, Malaysia (Vendor Code: 00029488).
- “O” marked parts are recommended to be kept in stock.