

PUHZ-ZRP35VKA
PUHZ-ZRP50VKA

Unit : mm

PIPING-WIRING DIRECTION

Piping and wiring connection can be made from the rear direction only.

FOUNDATION BOLTS

Please secure the unit firmly with 4 foundation (M10) bolts. (Bolts, washers and nut must be purchased locally).

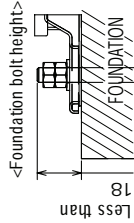

Free space around the outdoor unit (basic example)

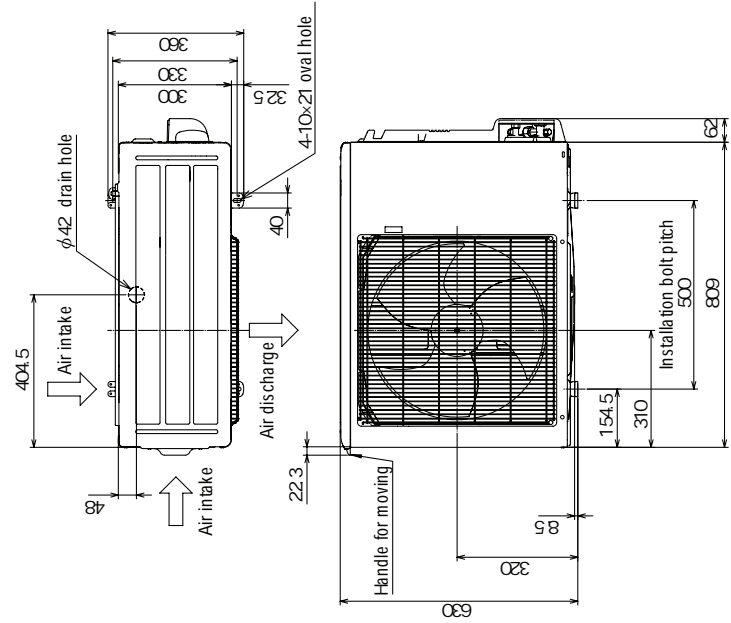
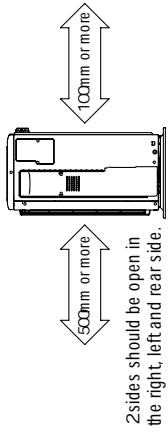
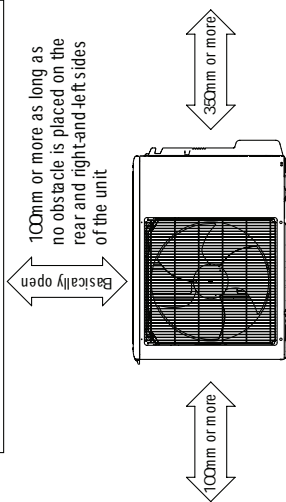

PUHZ-ZRP60VHA
PUHZ-ZRP71VHA

Unit : mm

4 PIPING-WIRING DIRECTIONS

Piping and wiring connections can be made from 4 directions: front, right, rear and below.

3 FOUNDATION BOLTS

Please secure the unit firmly with 4 foundation (M10) bolts. (Bolts and washers must be purchased locally.)

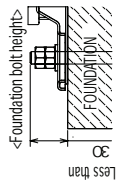

2 SERVICE SPACE

Dimensions of space needed for service access are shown in the below diagram.

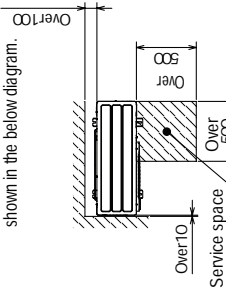

1 FREE SPACE (Around the unit)

The diagram below shows a basic example. Explanation of particular details is given in the installation manuals etc.

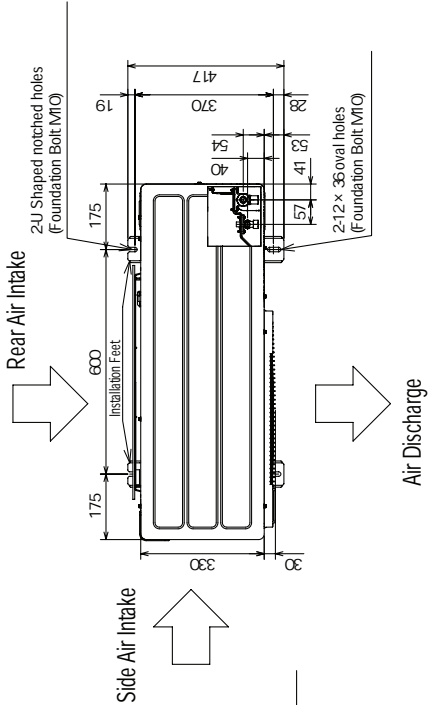
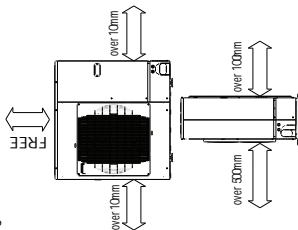

Example of Notes

- ① Refrigerant GAS pipe connection (FLARE) φ15.88(5/8inch)
- ② Refrigerant LIQUID pipe connection (FLARE) φ9.52(3/8inch)
- *1...Indication of STOP VALVE connection location.

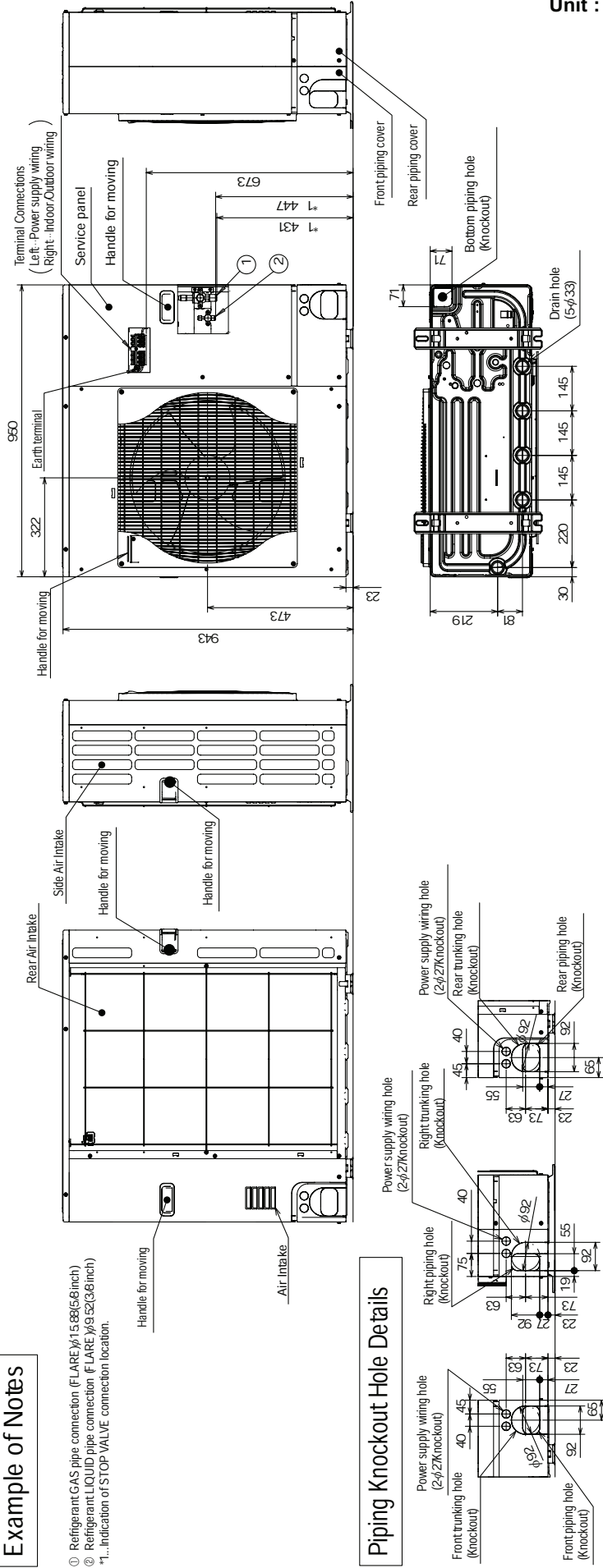

Piping Knockout Hole Details

