

# Air-Conditioners For Building Application INDOOR UNIT

## PLFY-P·VFM-E1

### OPERATION MANUAL

**FOR USER**

For safe and correct use, please read this operation manual thoroughly before operating the air-conditioner unit.

### BEDIENUNGSHANDBUCH

**FÜR BENUTZER**

Zum sicheren und einwandfreien Gebrauch der Klimaanlage dieses Bedienungshandbuch vor Inbetriebnahme gründlich durchlesen.

### MANUEL D'UTILISATION

**POUR L'UTILISATEUR**

Pour une utilisation correcte sans risques, veuillez lire le manuel d'utilisation en entier avant de vous servir du climatiseur.

### BEDIENINGSHANDLEIDING

**VOOR DE GEBRUIKER**

Voor een veilig en juist gebruik moet u deze bedieningshandleiding grondig doorlezen voordat u de airconditioner gebruikt.

### MANUAL DE INSTRUCCIONES

**PARA EL USUARIO**

Lea este manual de instrucciones hasta el final antes de poner en marcha la unidad de aire acondicionado para garantizar un uso seguro y correcto.

### ISTRUZIONI DI FUNZIONAMENTO

**PER L'UTENTE**

Leggere attentamente questi istruzioni di funzionamento prima di avviare l'unità, per un uso corretto e sicuro della stessa.

### ΕΓΧΕΙΡΙΔΙΟ ΟΔΗΓΙΩΝ ΧΡΗΣΕΩΣ

**ΓΙΑ ΤΟΝ ΧΡΗΣΤΗ**

Για ασφάλεια και σωστή χρήση, παρακαλείστε διαβάσετε προσεκτικά αυτό το εγχειρίδιο χρήσεως πριν θέσετε σε λειτουργία τη μονάδα κλιματισμού.

### MANUAL DE OPERAÇÃO

**PARA O UTILIZADOR**

Para segurança e utilização correctas, leia atentamente o manual de operação antes de pôr a funcionar a unidade de ar condicionado.

### DRIFTSMANUAL

**TIL BRUGER**

Læs venligst denne driftsmanual grundigt før airconditionanlægget betjenes af hensyn til sikker og korrekt brug.

### DRIFTSMANUAL

**FÖR ANVÄNDAREN**

Läs denna driftsmanual noga för säkert och korrekt bruk innan luftkonditioneringen används.

### İŞLETME ELKİTABI

**KULLANICI İÇİN**

Emniyetli ve doğru biçimde nasıl kullanılacağını öğrenmek için lütfen klima cihazını işletmeden önce bu elkitabını dikkatle okuyunuz.

### РУКОВОДСТВО ПО ЭКСПЛУАТАЦИИ

**ДЛЯ ПОЛЬЗОВАТЕЛЯ**

Для обеспечения правильного и безопасного использования следует ознакомиться с инструкциями, указанными в данном руководстве по эксплуатации, тщательным образом до того, как приступить к использованию кондиционера.

### BRUKSANVISNING

**FOR BRUKER**

Vennligst les nøye gjennom denne bruksanvisningen, for sikkert og riktig bruk av klimaanlegget.

### INSTRUKCJA OBSŁUGI

**INFORMACJA DLA UŻYTKOWNIKA**

Aby zapewnić bezpieczne i prawidłowe korzystanie z urządzenia, należy wcześniej uważnie przeczytać niniejszą instrukcję obsługi.

**English (GB)****Deutsch (D)****Français (F)****Nederlands (NL)****Español (E)****Italiano (I)****Ελληνικά (GR)****Português (P)****Dansk (DA)****Svenska (SV)****Türkçe (TR)****Русский (RU)****Norsk (NO)****Polski (PL)**

# Contents

1. Safety Precautions .....	2	5. Emergency Operation for Wireless Remote-controller .....	14
2. Parts Names .....	3	6. Care and Cleaning .....	14
3. Operation .....	6	7. Troubleshooting .....	16
4. Timer .....	13	8. Specifications .....	17

## Note:

The phrase "Wired remote controller" in this operation manual refers to the PAR-32MAA.  
If you need any information for the other remote controller, please refer to the instruction book included in this box.

## 1. Safety Precautions

- ▶ Before installing the unit, make sure you read all the "Safety Precautions".
- ▶ The "Safety Precautions" provide very important points regarding safety. Make sure you follow them.
- ▶ Please report to or take consent by the supply authority before connection to the system.

### Symbols used in the text

#### ⚠ Warning:

Describes precautions that should be observed to prevent danger of injury or death to the user.

#### ⚠ Caution:

Describes precautions that should be observed to prevent damage to the unit.

### Symbols used in the illustrations

⚡: Indicates a part which must be grounded.

#### ⚠ Warning:

- These appliances are not accessible to the general public.
- The unit must not be installed by the user. Ask the dealer or an authorized company to install the unit. If the unit is installed improperly, water leakage, electric shock or fire may result.
- Do not stand on, or place any items on the unit.
- Do not splash water over the unit and do not touch the unit with wet hands. An electric shock may result.
- Do not spray combustible gas close to the unit. Fire may result.
- Do not place a gas heater or any other open-flame appliance where it will be exposed to the air discharged from the unit. Incomplete combustion may result.
- Do not remove the front panel or the fan guard from the outdoor unit when it is running.
- Never repair the unit or transfer it to another site by yourself.
- When you notice exceptionally abnormal noise or vibration, stop operation, turn off the power switch, and contact your dealer.
- Never insert fingers, sticks etc. into the air inlets or outlets.
- If you detect odd smells, stop using the unit, turn off the power switch and consult your dealer. Otherwise, a breakdown, electric shock or fire may result.
- This air conditioner is NOT intended for use by children or infirm persons without supervision.
- If the refrigeration gas blows out or leaks, stop the operation of the air conditioner, thoroughly ventilate the room, and contact your dealer.
- This appliance is intended to be used by expert or trained users in shops, in light industry and on farms, or for commercial use by lay persons.

- Young children must be supervised to ensure that they do not play with the air conditioner.
- This appliance is not intended for use by persons (including children) with reduced physical, sensory or mental capabilities, or lack of experience and knowledge, unless they have been given supervision or instruction concerning use of the appliance by a person responsible for their safety.
- This appliance can be used by children aged from 8 years and above and persons with reduced physical, sensory or mental capabilities or lack of experience and knowledge if they have been given supervision or instruction concerning use of the appliance in a safe way and understand the hazards involved. Children shall not play with the appliance. Cleaning and user maintenance shall not be made by children without supervision.
- When installing or relocating, or servicing the air conditioner, use only the specified refrigerant (R410A) to charge the refrigerant lines. Do not mix it with any other refrigerant and do not allow air to remain in the lines.  
If air is mixed with the refrigerant, then it can be the cause of abnormal high pressure in the refrigerant line, and may result in an explosion and other hazards. The use of any refrigerant other than that specified for the system will cause mechanical failure or system malfunction or unit breakdown. In the worst case, this could lead to a serious impediment to securing product safety.

#### ⚠ Caution:

- Do not use any sharp object to push the buttons, as this may damage the remote controller.
- Never block or cover the indoor or outdoor unit's air inlets or outlets.
- Never wipe the remote controller with benzene, thinner chemical rags, etc.
- Do not operate the unit for a long time in high humidity, e.g. leaving a door or window open. In the cool mode, if the unit is operated in a room with high humidity (80% RH or more) for a

long time, water condensed in the air conditioner may drop and wet or damage furniture, etc.

- Do not touch the upper air outlet vane or the lower air outlet damper during operation. Otherwise, condensation may form and the unit may stop operating.

### Disposing of the unit

When you need to dispose of the unit, consult your dealer.

## 2. Parts Names

### Indoor Unit

		PLFY-P·VFM-E1
Fan speed	3 speed + Auto	
Vane	Steps	5 steps
	Auto Swing	○
Louver	—	
Filter	Long-life	
Filter cleaning indication	2,500 hr	
Enter the model setting number for the indoor unit you want to operate.	066 (002)	

\* For systems that are capable of simultaneous cooling and heating operation, use the setting indicated in parentheses ( ). For details on the setting procedure, refer to the Installation Manual.

### Wired Remote Controller

#### Controller interface

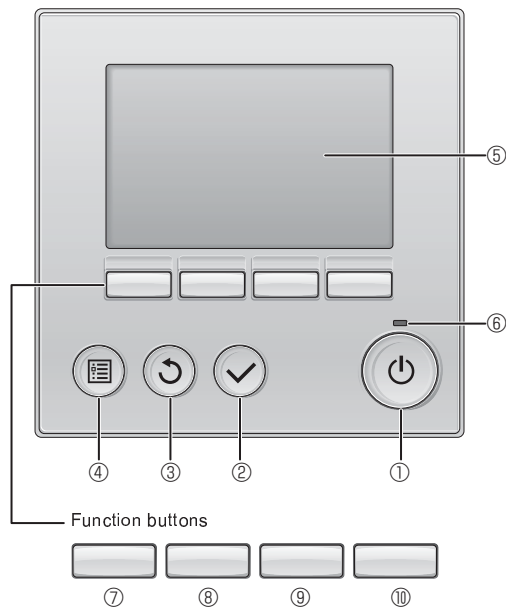

#### ① [ON/OFF] button

Press to turn ON/OFF the indoor unit.

#### ② [SELECT] button

Press to save the setting.

#### ③ [RETURN] button

Press to return to the previous screen.

#### ④ [MENU] button

Press to bring up the Main menu.

#### ⑤ Backlit LCD

Operation settings will appear.

When the backlight is off, pressing any button turns the backlight on and it will stay lit for a certain period of time depending on the screen.

When the backlight is off, pressing any button turns the backlight on and does not perform its function. (except for the [ON/OFF] button)

### PLFY-P·VFM-E1

#### 4-way Ceiling Cassette

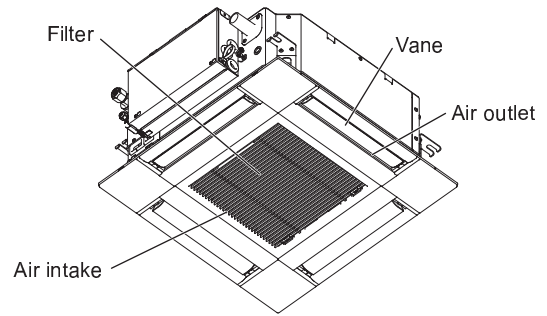

The functions of the function buttons change depending on the screen.

Refer to the button function guide that appears at the bottom of the LCD for the functions they serve on a given screen.

When the system is centrally controlled, the button function guide that corresponds to the locked button will not appear.

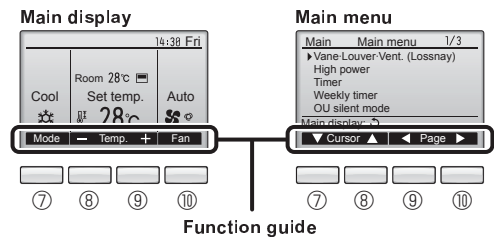

#### ⑥ ON/OFF lamp

This lamp lights up in green while the unit is in operation. It blinks while the remote controller is starting up or when there is an error.

#### ⑦ Function button [F1]

Main display: Press to change the operation mode.

Main menu: Press to move the cursor down.

#### ⑧ Function button [F2]

Main display: Press to decrease temperature.

Main menu: Press to move the cursor up.

#### ⑨ Function button [F3]

Main display: Press to increase temperature.

Main menu: Press to go to the previous page.

#### ⑩ Function button [F4]

Main display: Press to change the fan speed.

Main menu: Press to go to the next page.

## 2. Parts Names

### Display

The main display can be displayed in two different modes: "Full" and "Basic". The factory setting is "Full". To switch to the "Basic" mode, change the setting on the Main display setting. (Refer to operation manual included with remote controller.)

<Full mode>

\* All icons are displayed for explanation.

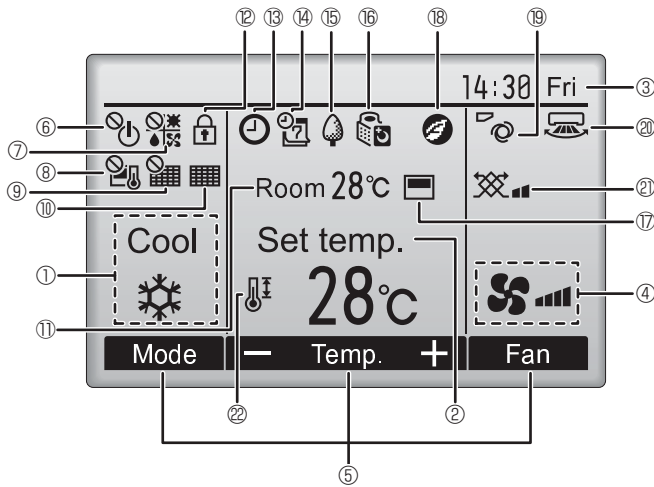

<Basic mode>

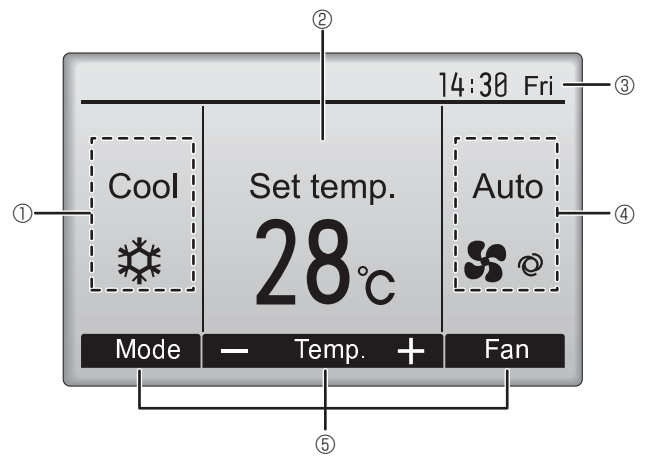

#### ① Operation mode

Indoor unit operation mode appears here.

#### ② Preset temperature

Preset temperature appears here.

#### ③ Clock (See the Installation Manual.)

Current time appears here.

#### ④ Fan speed

Fan speed setting appears here.

#### ⑤ Button function guide

Functions of the corresponding buttons appear here.



Appears when the ON/OFF operation is centrally controlled.



Appears when the operation mode is centrally controlled.



Appears when the preset temperature is centrally controlled.



Appears when the filter reset function is centrally controlled.



Indicates when filter needs maintenance.

#### ⑪ Room temperature (See the Installation Manual.)

Current room temperature appears here.



Appears when the buttons are locked.



Appears when the On/Off timer, Night setback, or Auto-off timer function is enabled.



Appears when the timer is disabled by the centralized control system.



Appears when the Weekly timer is enabled.



Appears while the units are operated in the energy-save mode. (Will not appear on some models of indoor units)



Appears while the outdoor units are operated in the silent mode. (This indication is not available for CITY MULTI models.)



Appears when the built-in thermistor on the remote controller is activated to monitor the room temperature (⑪).



Appears when the thermistor on the indoor unit is activated to monitor the room temperature.



Appears when the units are operated in the energy-save mode with 3D i-see Sensor.



Indicates the vane setting.



Indicates the louver setting.



Indicates the ventilation setting.



Appears when the preset temperature range is restricted.

Most settings (except ON/OFF, mode, fan speed, temperature) can be made from the Menu screen. (Refer to operation manual included with remote controller.)

## 2. Parts Names

### ■ Wireless Remote-Controller (Optional parts)

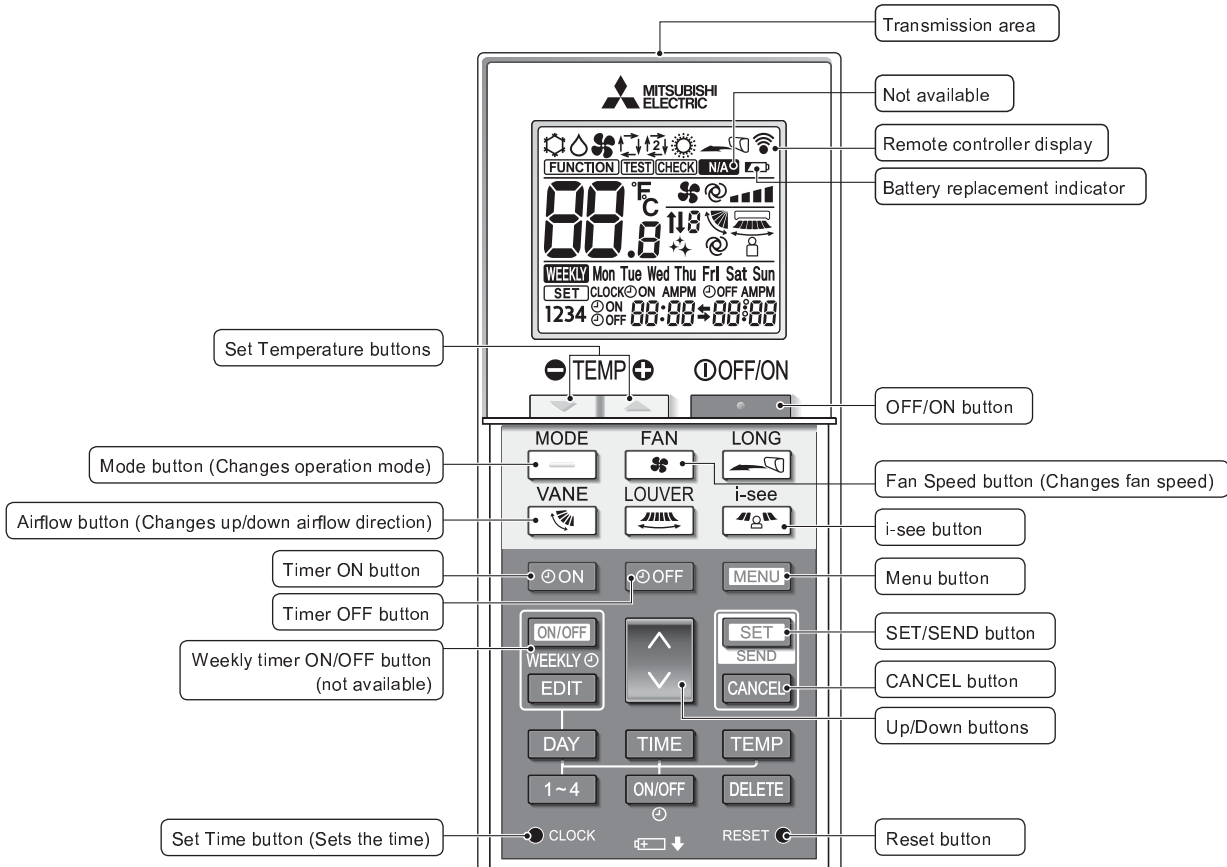

**Operation mode**

Cool	Dry
Fan	Auto (single set point)
Heat	Auto* (dual set point)

\* The initial setting is necessary. Refer to Installation manual.

**Temperature setting**  
The units of temperature can be changed. For details, refer to the Installation manual.

**Vane setting**

Step 1 Step 2 Step 3 Step 4 Step 5 Swing Auto

**Not available**  
Appears when a non-supported function is selected.

**Battery replacement indicator**  
Appears when the remaining battery power is low.

**Fan speed setting**

**3D i-see sensor (Air distribution)**

Default Direct Indirect

When Direct or Indirect is selected, the vane setting is set to "Auto".

## 2. Parts Names

### Notes (Only for wireless remote controller):

- When using the wireless remote controller, point it towards the receiver on the indoor unit.
- If the remote controller is operated within approximately 2 minutes after power is supplied to the indoor unit, the indoor unit may beep twice as the unit is performing the initial automatic check.
- The indoor unit beeps to confirm that the signal transmitted from the remote controller has been received. Signals can be received up to approximately 7 meters in a direct line from the indoor unit in an area 45° to the left and right of the unit. However, illumination such as fluorescent lights and strong light can affect the ability of the indoor unit to receive signals.
- If the operation lamp near the receiver on the indoor unit is blinking, the unit needs to be inspected. Consult your dealer for service.
- Handle the remote controller carefully! Do not drop the remote controller or subject it to strong shocks. In addition, do not get the remote controller wet or leave it in a location with high humidity.
- To avoid misplacing the remote controller, install the holder included with the remote controller on a wall and be sure to always place the remote controller in the holder after use.
- If the indoor unit beeps 4 times when you are using the wireless remote controller, switch the auto mode setting to the AUTO (single set point) mode or AUTO (dual set point) mode. For details, refer to the included Notice (A5 sheet) or the Installation Manual.

### Battery installation/replacement

1. Remove the top cover, insert two LR6 AA batteries, and then install the top cover.

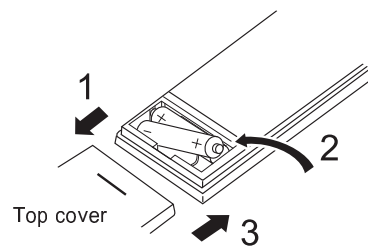

Two LR6 AA batteries  
Insert the negative (-) end of each battery first. Install the batteries in the correct directions (+, -)!

2. Press the Reset button.

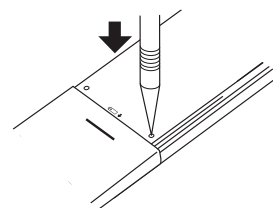

Press the Reset button with an object that has a narrow end.

## 3. Operation

- About the operation method, refer to the operation manual that comes with each remote controller.

### 3.1. Turning ON/OFF

#### [ON]



Press the [ON/OFF] button.  
The ON/OFF lamp will light up in green, and the operation will start.

#### [OFF]



Press the [ON/OFF] button again.  
The ON/OFF lamp will come off, and the operation will stop.

#### Note:

Even if you press the ON/OFF button immediately after shutting down the operation in progress, the air conditioner will not start for about 3 minutes. This is to prevent the internal components from being damaged.

#### ■ Operation status memory

	Remote controller setting
Operation mode	Operation mode before the power was turned off
Preset temperature	Preset temperature before the power was turned off
Fan speed	Fan speed before the power was turned off

#### ■ Settable preset temperature range

Operation mode	Preset temperature range
Cool/Dry	19 – 30 °C
Heat	17 – 28 °C
Auto (Single set point)	19 – 28 °C
Auto (Dual set points)	[Cool] Preset temperature range for the Cool mode [Heat] Preset temperature range for the Heat mode
Fan/Ventilation	Not settable

The settable temperature range varies with the model of outdoor units and remote controller.

### 3. Operation

#### 3.2. Mode Selection

Press the [F1] button to go through the operation modes in the order of "Cool", "Dry", "Fan", "Auto", and "Heat". Select the desired operation mode.

- Operation modes that are not available to the connected outdoor unit models will not appear on the display.

**What the blinking mode icon means**  
The mode icon will blink when other indoor units in the same refrigerant system (connected to the same outdoor unit) are already operated in a different mode. In this case, the rest of the unit in the same group can only be operated in the same mode.

#### 3.3. Temperature setting

##### <Cool, Dry, Heat, and Auto (single set point)>

Example display (Centigrade in 0.5-degree increments)

Press the [F2] button to decrease the preset temperature, and press the [F3] button to increase.

- Refer to the table on page 6 for the settable temperature range for different operation modes.
- Preset temperature range cannot be set for Fan/Ventilation operation.
- Preset temperature will be displayed either in Centigrade in 0.5- or 1-degree increments, or in Fahrenheit, depending on the indoor unit model and the display mode setting on the remote controller.

##### Automatic operation (single set point)

- According to a set temperature, cooling operation starts if the room temperature is too hot and heating operation starts if the room temperature is too cold.
- During automatic operation, if the room temperature changes and remains 1.5 °C or more above the set temperature for 3 minutes, the air conditioner switches to cool mode. In the same way, if the room temperature remains 1.5 °C or more below the set temperature for 3 minutes, the air conditioner switches to heat mode.

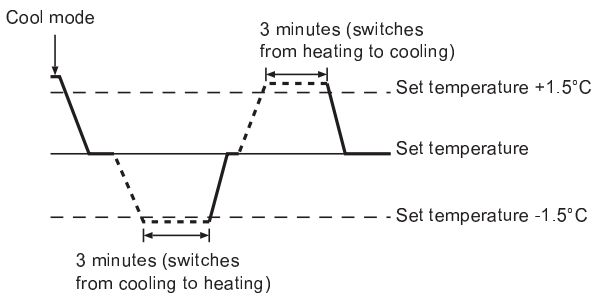

- Because the room temperature is automatically adjusted in order to maintain a fixed effective temperature, cooling operation is performed a few degrees warmer and heating operation is performed a few degrees cooler than the set room temperature once the temperature is reached (automatic energy-saving operation).

##### <Auto (dual set point) mode>

- ① The current preset temperatures will appear. Press the [F2] or [F3] button to display the Settings screen.

- ② Press the [F1] or [F2] button to move the cursor to the desired temperature setting (cooling or heating). Press the [F3] button to decrease the selected temperature, and [F4] to increase.
  - Refer to the table on page 6 for the settable temperature range for different operation modes.
  - The preset temperature settings for cooling and heating in the Auto (dual set point) mode are also used by the Cool/Dry and Heat modes.
  - The preset temperatures for cooling and heating in the Auto (dual set point) mode must meet the conditions below:
    - Preset cooling temperature is higher than preset heating temperature.
    - The minimum temperature difference requirement between cooling and heating preset temperatures (varies with the models of indoor units connected) is met.
  - \* If preset temperatures are set in a way that does not meet the minimum temperature difference requirement, both preset temperatures will automatically be changed within the allowable setting ranges.

**Navigating through the screens**

- To return to the Main screen ..... [RETURN] button

##### <Auto operation (dual set point) mode>

When the operation mode is set to the Auto (dual set point) mode, two preset temperatures (one each for cooling and heating) can be set. Depending on the room temperature, indoor unit will automatically operate in either the Cool or Heat mode and keep the room temperature within the preset range.

The graph below shows the operation pattern of indoor unit operated in the Auto (dual set point) mode.

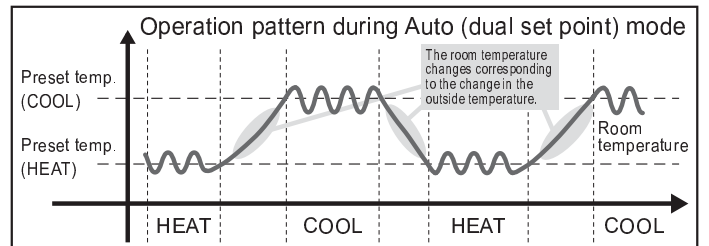

### 3. Operation

#### 3.4. Fan speed setting

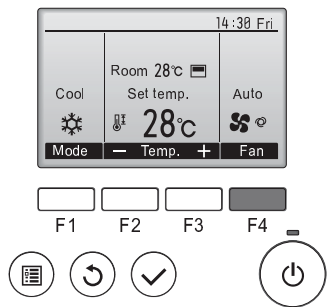

Press the [F4] button to go through the fan speeds in the following order.

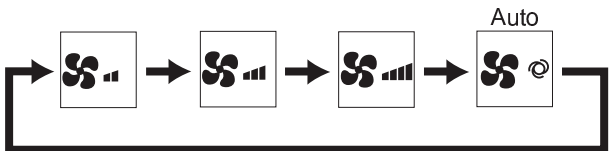

- The available fan speeds depend on the models of connected indoor units.

**Notes:**

- The number of available fan speeds depends on the type of unit connected. Note also that some units do not provide an “Auto” setting.
- In the following cases, the actual fan speed generated by the unit will differ from the speed shown the remote controller display.
  1. While the display is showing “STAND BY” or “DEFROST”.
  2. When the temperature of the heat exchanger is low in the heat mode. (e.g. immediately after heat operation starts)
  3. In HEAT mode, when room temperature is higher than the temperature setting.
  4. When the unit is in DRY mode.

#### 3.5. Airflow direction setting

##### 3.5.1 Navigating through the Main menu

###### <Accessing the Main menu>

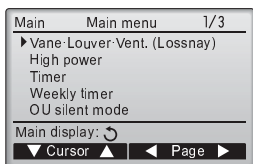

Press the [MENU] button. The Main menu will appear.

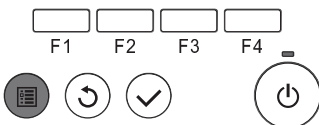

###### <Item selection>

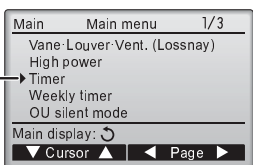

Press [F1] to move the cursor down. Press [F2] to move the cursor up.

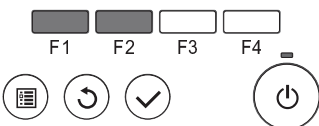

###### <Navigating through the pages>

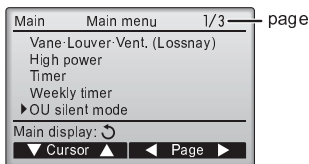

Press [F3] to go to the previous page. Press [F4] to go to the next page.

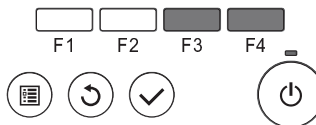

###### <Exiting the Main menu screen>

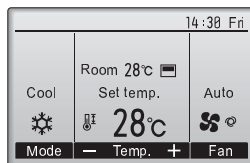

Press the [RETURN] button to exit the Main menu and return to the Main display.

If no buttons are touched for 10 minutes, the screen will automatically return to the Main display. Any settings that have not been saved will be lost.

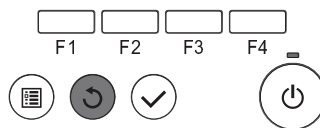

###### <Display of unsupported functions>

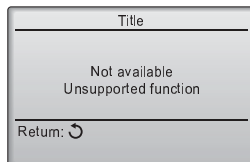

The message at left will appear if the user selects a function not supported by the corresponding indoor unit model.

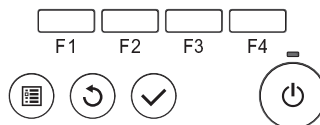

##### 3.5.2 Vane·Vent. (Lossnay)

###### <Accessing the menu>

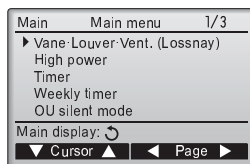

Select “Vane·Louver·Vent. (Lossnay)” from the Main menu (refer to page 8), and press the [SELECT] button.

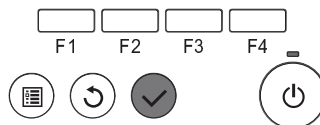



### 3. Operation

#### <Vane setting>

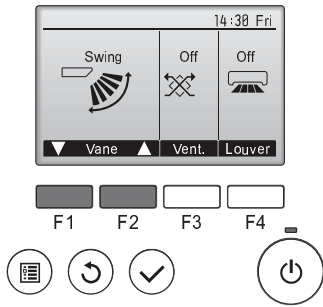

Press the [F1] or [F2] button to go through the vane setting options: "Auto", "Step 1", "Step 2", "Step 3", "Step 4", "Step 5" and "Swing". Select the desired setting.

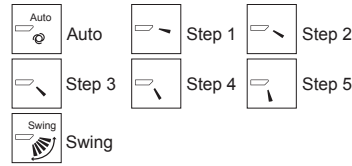

Select "Swing" to move the vanes up and down automatically. When set to "Step 1" through "Step 5", the vane will be fixed at the selected angle.

#### <Vent. setting>

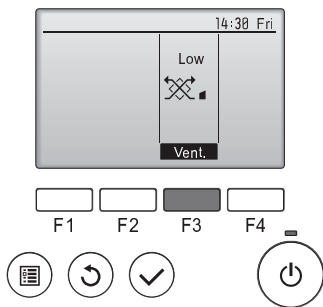

Press the [F3] button to go through the ventilation setting options in the order of "Off", "Low", and "High". \* Settable only when LOSSNAY unit is connected.



The fan on some models of indoor units may be interlocked with certain models of ventilation units.

#### <Returning to the Main menu>

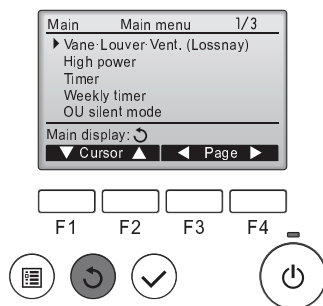

Press the [RETURN] button to go back to the Main menu.

#### < How to set the fixed up/down air direction >

##### Notes:

- This function cannot be set depending on the outdoor unit to be connected.
- For PLFY-P·VFM-E series, only the particular outlet can be fixed to certain direction with the procedures below. Once fixed, only the set outlet is fixed every time air conditioner is turned on. (Other outlets follow UP/DOWN air direction setting of remote controller.)

##### ■ Explanation of word

- "Refrigerant address No." and "Unit No." are the numbers given to each air conditioner.
- "Outlet No." is the number given to each outlet of air conditioner. (Refer to the illustration below.)
- "Up/Down air direction" is the direction (angle) to fix.

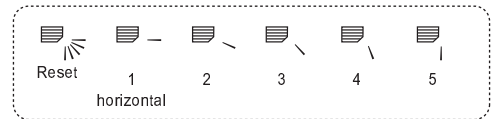

##### Remote controller setting

The airflow direction of this outlet is controlled by the airflow direction setting of remote controller.

##### Fixed

The airflow direction of this outlet is fixed in particular direction. \* When it is cold because of direct airflow, the airflow direction can be fixed horizontally to avoid direct airflow.

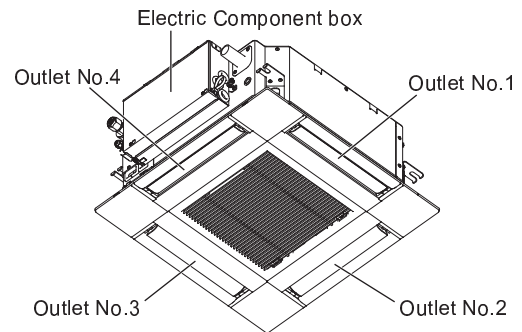

##### Note:

The outlet No. is indicated by the number of grooves on both ends of each air outlet. Set the air direction while checking the information shown on the remote controller display.

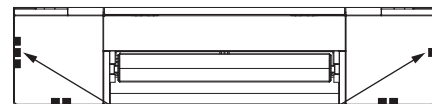

Air outlet identification marks

### 3. Operation

#### Manual vane angle (Wired remote controller)

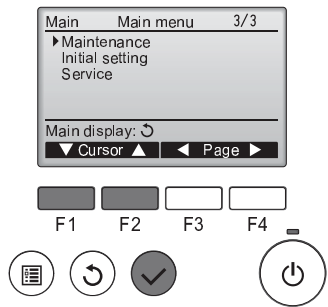

① Select "Maintenance" from the Main menu (refer to page 8), and press the [SELECT] button.



② Select "Manual vane angle" with the [F1] or [F2] button, and press the [SELECT] button.

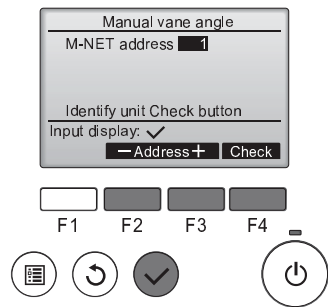

③ Select the "M-NET address" for the units to whose vanes are to be fixed, with the [F2] or [F3] button, and press the [SELECT] button. Press the [F4] button to confirm the unit. The vane of only the target indoor unit is pointing downward.

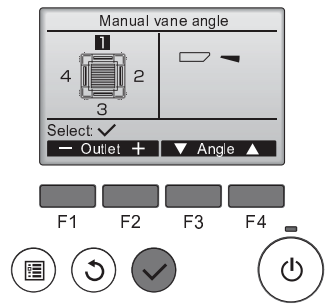

④ The current vane setting will appear.

Select the desired outlets from 1 through 4 with the [F1] or [F2] button.

- Outlet: "1", "2", "3", "4" and "1, 2, 3, 4, (all outlets)"

Press the [F3] or [F4] button to go through the option in the order of "No setting (reset)", "Step 1", "Step 2", "Step 3", "Step 4", "Step 5" and "Draft reduction\*". Select the desired setting.

\* Draft reduction  
The airflow direction for this setting is more horizontal than the airflow direction for the "Step 1" setting in order to reduce a drafty feeling. The draft reduction can be set for only 1 vane.

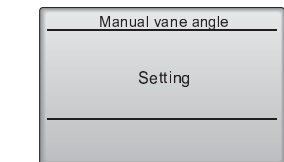

**Note:**  
Do not set the draft reduction in an environment with high humidity. Otherwise, condensation may form and drip.

#### Vane setting

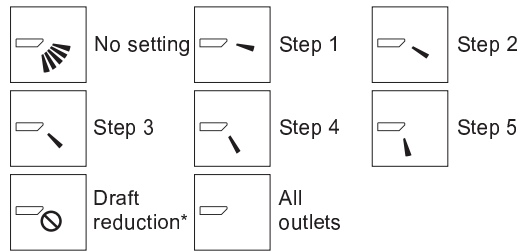

Press the [SELECT] button to save the settings. A screen will appear that indicates the setting information is being transmitted. The setting changes will be made to the selected outlet. The screen will automatically return to the one shown above (step 5) when the transmission is completed. Make the settings for other outlets, following the same procedures.

If all outlets are selected, will be displayed the next time the unit goes into operation.

Navigating through the screens

- To go back to the Main menu..... [MENU] button
- To return to the previous screen ..... [RETURN] button

#### Confirmation procedure

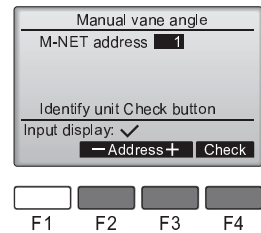

① Select the "M-NET address" for the units to whose vanes are to be fixed, with the [F2] or [F3] button. Press the [F4] button to confirm the unit.

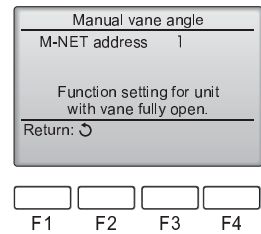

② After pressing the [F4] button, wait approximately 15 seconds, and then check the current state of the air conditioner.  
→ The vane is pointing downward.  
→ This air conditioner is displayed on the remote controller.  
→ All outlets are closed. → Press the [RETURN] button and continue the operation from the beginning.  
→ The messages shown to the left are displayed. → The target device does not exist at this refrigerant address.

• Press the [RETURN] button to return to the initial screen.

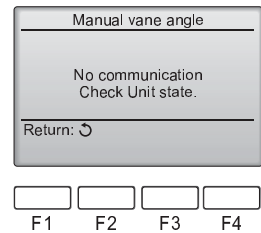

③ Change the "M-NET address" to the next number.  
• Refer to step ① to change the "M-NET address" and continue with the confirmation.

**⚠ Caution:**  
To prevent falls, maintain a stable footing when operating the unit.

### 3. Operation

#### Manual vane angle (Wireless remote controller)

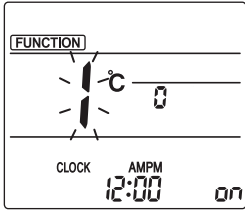

Fig. 3-1

- Going to the Manual vane setting mode  
Press the **[MENU]** button.  
(Start this operation from the status of remote controller display turned off.)  
"FUNCTION" is lighted and "1" blinks. (Fig. 3-1)  
Press the **[▲]** button to select "2", and then press the **[SET]** button.

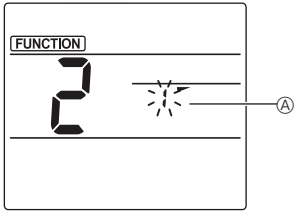

Fig. 3-2

- Selecting the vane number (Fig. 3-2)  
Press the **[▼]** buttons to select the vane number **Ⓐ**, and then press the **[SET]** button.

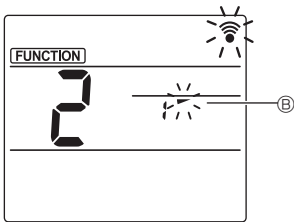

Fig. 3-3

- Setting the vane angle (Fig. 3-3)  
Press the **[▼]** buttons to select the vane angle **Ⓑ**.  
Point the wireless remote controller toward the receiver on the indoor unit, and then press the **[SET]** button.
- Press the **[MENU]** button to complete the settings.

Display	↗	↘	↙	↘
Setting	Step 1	Step 2	Step 3	Step 4
Display	↙	↘	No display	
Setting	Step 5	No setting	Draft reduction*	

\* The draft reduction can be set for only 1 vane.  
The setting is enabled only for the last vane that was set.

#### 3.6. 3D i-See sensor setting

##### 3.6.1 3D i-See sensor setting

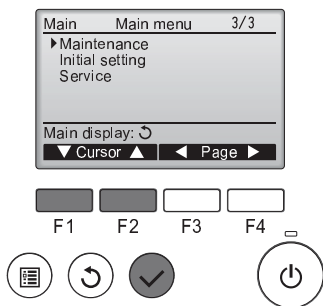

- Select "Maintenance" from the Main menu (refer to page 8), and press the **[SELECT]** button.

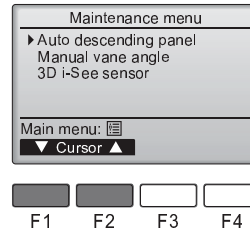

- Select "3D i-See sensor" with the **[F1]** or **[F2]** button, and press the **[SELECT]** button.

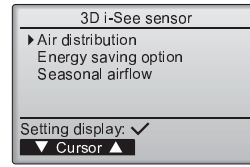

- Select the desired menu with the **[F1]** or **[F2]** button, and press the **[SELECT]** button.
  - Air distribution  
Select the airflow direction control method when the airflow direction is set to "Auto".
  - Energy saving option  
Operates the energy-save mode according to whether persons are detected in the room by the 3D i-See sensor.
  - Seasonal airflow  
When the thermostat turns off, the fan and the vanes operate according to the control settings.

##### 3.6.2 Air distribution

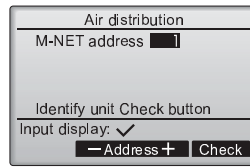

- Select the M-NET address for the units to whose vanes are to be fixed, with the **[F2]** or **[F3]** button, and press the **[SELECT]** button. Press the **[F4]** button to confirm the unit.  
The vane of only the target indoor unit is pointing downward.

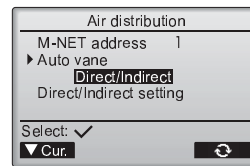

- Select the menu with the **[F4]** button.  
Default → Area → Direct/Indirect → Default...  
Default: The vanes move the same as during normal operation. During cooling mode, all of the vanes move to the horizontal airflow direction. During heating mode, all of the vanes move to the down airflow direction.  
Area: The vanes move to the down airflow direction toward areas with a high floor temperature during cooling mode and toward areas with a low floor temperature during heating mode. Otherwise, the vanes move to the horizontal airflow direction.  
Direct/Indirect: The vanes automatically move relative to the areas where persons are detected. The vanes operate as indicated in the following table.

	Vane setting	
	Direct	Indirect
Cooling	horizontal → swing	keep horizontal
Heating	keep downward	downward → horizontal

### 3. Operation

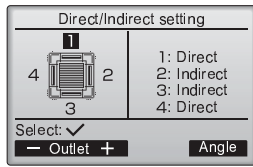

③ When Direct/Indirect is selected, set each air outlet.  
 Select the air outlet with the [F1] or [F2] button, and change the setting with the [F4] button.  
 After changing the settings for all of the air outlets, press the [SELECT] button to save the settings.

\* In order to enable this function, the airflow direction must be set to "Auto".

#### ■ i-See button (Wireless remote controller)

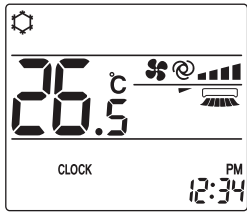

① Each time is pressed during operation, the setting changes in the following order: OFF → Direct → Indirect.

Display			
Setting	OFF	Direct	Indirect

When the setting is changed from OFF to Direct or Indirect, the vane setting changes to "Auto". This setting is applied collectively to all of the vanes.

#### 3.6.3 Energy saving option

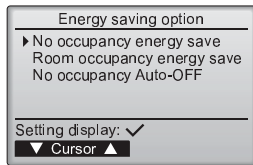

① Select the desired menu with the [F1] or [F2] button.

**No occupancy energy save**  
 If there are no persons in the room for 60 minutes or more, energy-saving operation equal to 2 °C is performed.

**Room occupancy energy save**  
 If the occupancy rate decreases to approximately 30% of the maximum occupancy rate, energy-saving operation equal to 1 °C is performed.

**No occupancy Auto-OFF**  
 If there are no persons in the room for the set amount of time (60–180 minutes), the operation is automatically stopped.

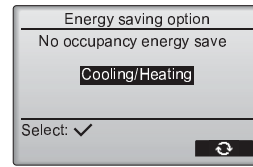

② When No occupancy energy save or Room occupancy energy save is selected

Select the setting with the [F4] button.  
 OFF → Cooling only → Heating only → Cooling/Heating → OFF...

After changing the setting, press the [SELECT] button to save the setting.

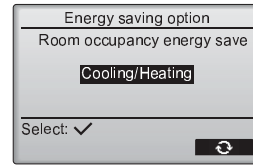

OFF: The function is disabled.  
 Cooling only: The function is enabled only during cooling mode.  
 Heating only: The function is enabled only during heating mode.  
 Cooling/Heating: The function is enabled during both cooling mode and heating mode.

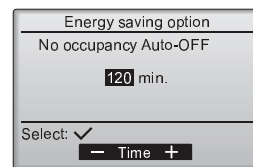

③ When No occupancy Auto-OFF is selected  
 Set the time with the [F3] or [F4] button.

—: The setting is disabled (the operation will not stop automatically).  
 60 – 180: The time can be set in 10-minute increments.

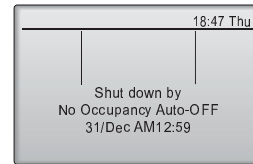

④ The message at left will appear if the operation was stopped automatically by the No occupancy Auto-OFF setting.

## 3. Operation

### 3.6.4 Seasonal airflow function



- ① Select the setting with the [F4] button.  
OFF → Cooling only → Heating only → Cooling/Heating → OFF...

After changing the setting, press the [SELECT] button to save the setting.

OFF: The function is disabled.  
Cooling only: When the thermostat turns off during cooling mode, the vanes move up and down.  
Heating only: When the thermostat turns off during heating mode, the vanes move to the horizontal airflow direction to circulate the air.  
Cooling/Heating: The function is enabled during both cooling mode and heating mode.

- \* In order to enable this function, the airflow direction must be set to "Auto".

#### Notes:

Any person at the following places cannot be detected.

- Along the wall on which the air conditioner is installed
- Directly under the air conditioner
- Where any obstacle, such as furniture, is between the person and the air conditioner

A person may not be detected in the following situations.

- Room temperature is high.
- A person wears heavy clothes and his/her skin is not exposed.
- A heating element of which temperature changes significantly is present.
- Some heat sources, such as a small child or pet, may not be sensed.
- A heat source does not move for a long time.

The 3D i-See sensor operates once approximately every 3 minutes to measure the floor temperature and detect persons in the room.

- The intermittent operating sound is a normal sound produced when the 3D i-See sensor is moving.

#### Notes:

- During swing operation, the directional indication on the screen does not change in sync with the directional vanes on the unit.
- Available directions depend on the type of unit connected.
- In the following cases, the actual air direction will differ from the direction indicated on the remote controller display.
  1. While the display is in "STAND BY" or "DEFROST" states.
  2. Immediately after starting heat mode (while the system is waiting for the mode change to take effect).
  3. In heat mode, when room temperature is higher than the temperature setting.

### 3.7. Ventilation

For LOSSNAY combination

■ The following 2 patterns of operation is available.

- Run the ventilator together with indoor unit.
- Run the ventilator independently.

#### Notes: (for wireless remote controller)

- Running the ventilator independently is not available.
- No indication on the remote controller.

## 4. Timer

- Timer functions are different by each remote controller.
- For details on how to operate the remote controller, refer to the appropriate operation manual included with each remote controller.

## 5. Emergency Operation for Wireless Remote-controller

### ■ PLFY-P-VFM-E1

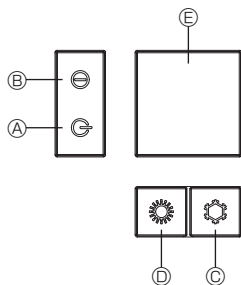
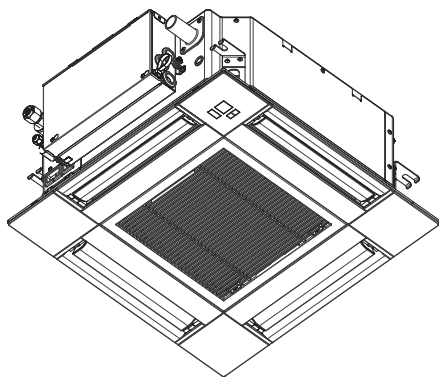

### When the remote controller cannot be used

When the batteries of the remote controller run out or the remote controller malfunctions, the emergency operation can be done using the emergency buttons on the grille.

- Ⓐ DEFROST/STAND BY lamp
- Ⓑ Operation lamp
- Ⓒ Emergency operation cooling switch
- Ⓓ Emergency operation heating switch
- Ⓔ Receiver

### Starting operation

- To operate the cooling mode, press the ⚙ button Ⓒ for more than 2 seconds.
- To operate the heating mode, press the ⚙ button Ⓓ for more than 2 seconds.
- Lighting of the Operation lamp Ⓑ means the start of operation.

### Notes:

- Details of emergency mode are as shown below.

Details of EMERGENCY MODE are as shown below.

Operation mode	COOL	HEAT
Set temperature	24°C	24°C
Fan speed	High	High
Airflow direction	Horizontal	Downward 4 (5)

### Stopping operation

- To stop operation, press the ⚙ button Ⓒ or the ⚙ button Ⓓ for more than 2 seconds.

## 6. Care and Cleaning

### ■ Filter information

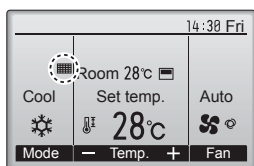

⏏ will appear on the Main display in the Full mode when it is time to clean the filters.

**Wash, clean, or replace the filters when this sign appears. Refer to the indoor unit Instructions Manual for details.**

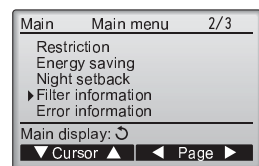

Select "Filter information" from the Main menu (refer to page 8), and press the [SELECT] button.

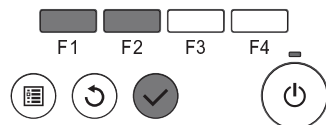

Press the [F4] button to reset filter sign. Refer to the indoor unit Instructions Manual for how to clean the filter.

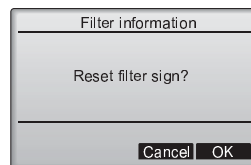
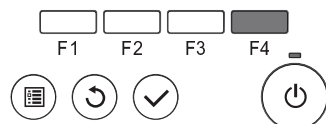

Select "OK" with the [F4] button.

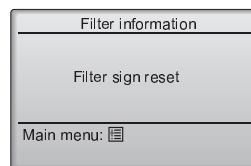
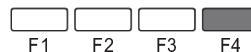



A confirmation screen will appear.

### Navigating through the screens

- To go back to the Main menu..... [MENU] button
- To return to the previous screen ..... [RETURN] button

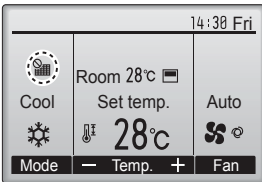
## 6. Care and Cleaning



When the  is displayed on the Main display in the Full mode, the system is centrally controlled and the filter sign cannot be reset.

If two or more indoor units are connected, filter cleaning timing for each unit may be different, depending on the filter type.

The icon  will appear when the filter on the main unit is due for cleaning.

When the filter sign is reset, the cumulative operation time of all units will be reset.

The icon  is scheduled to appear after a certain duration of operation, based on the premise that the indoor units are installed in a space with ordinary air quality. Depending on the air quality, the filter may require more frequent cleaning.

The cumulative time at which filter needs cleaning depends on the model.

- This indication is not available for wireless remote controller.

### ⚠ Caution:

- Ask authorized people to clean the filter.

### ► Cleaning the filters

- Clean the filters using a vacuum cleaner. If you do not have a vacuum cleaner, tap the filters against a solid object to knock off dirt and dust.
- If the filters are especially dirty, wash them in lukewarm water. Take care to rinse off any detergent thoroughly and allow the filters to dry completely before putting them back into the unit.

### ⚠ Caution:

- Do not dry the filters in direct sunlight or by using a heat source, such as an electric heater: this may warp them.
- Do not wash the filters in hot water (above 50°C), as this may warp them.
- Make sure that the air filters are always installed. Operating the unit without air filters can cause malfunction.

### ⚠ Caution:

- Before you start cleaning, stop operation and turn OFF the power supply.
- Indoor units are equipped with filters to remove the dust of sucked-in air. Clean the filters using the methods shown in the following sketches.

### ⚠ Caution:

- In removing the filter, precautions must be taken to protect your eyes from dust. Also, if you have to climb up on a stool to do the job, be careful not to fall.
- When the filter is removed, do not touch the metallic parts inside the indoor unit, otherwise injury may result.

### ■ PLFY-P-VFM-E1

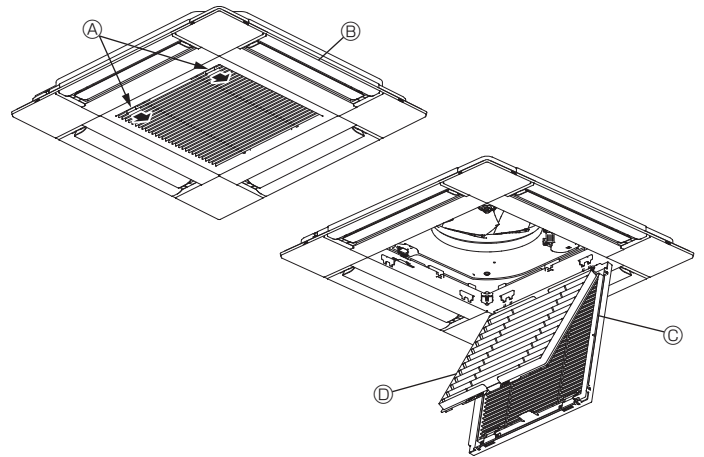

- ① Slide the levers on the intake grille in the direction indicated by the arrow and it should open.
- ② Open the intake grille.
- ③ Release the knob on the center edge of the intake grille and pull the filter forward to remove the filter.

- Ⓐ Intake grille levers
- Ⓑ Grille
- Ⓒ Intake grille
- Ⓓ Filter

### Cleaning the indoor unit

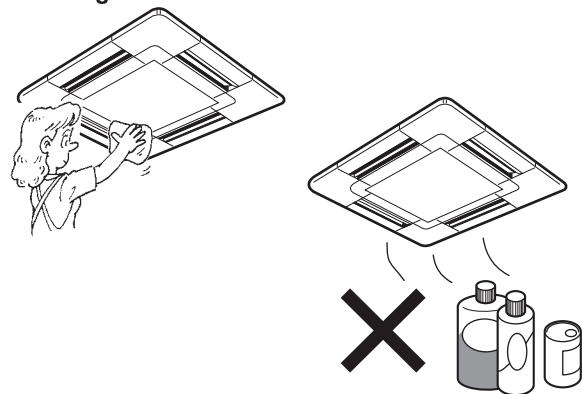







- Wipe the outside of the unit with a clean, dry, soft cloth.
- Clean off any oil stains or finger marks using a neutral household detergent (such as dishwashing liquid or laundry detergent).

### ⚠ Caution:

Never use gasoline, benzene, thinner, scouring powder or any type of non-neutral detergent, as these substances may damage the unit's case.

## 7. Troubleshooting

Having trouble?	Here is the solution. (Unit is operating normally.)
Air conditioner does not heat or cool well.	<ul style="list-style-type: none"> <li>■ Clean the filter. (Airflow is reduced when the filter is dirty or clogged.)</li> <li>■ Check the temperature adjustment and adjust the set temperature.</li> <li>■ Make sure that there is plenty of space around the outdoor unit. Is the indoor unit air inlet or outlet blocked?</li> <li>■ Has a door or window been left open?</li> </ul>
When heating operation starts, warm air does not blow from the indoor unit soon.	<ul style="list-style-type: none"> <li>■ Warm air does not blow until the indoor unit has sufficiently warmed up.</li> </ul>
During heat mode, the air conditioner stops before the set room temperature is reached.	<ul style="list-style-type: none"> <li>■ When the outdoor temperature is low and the humidity is high, frost may form on the outdoor unit. If this occurs, the outdoor unit performs a defrosting operation. Normal operation should begin after approximately 10 minutes.</li> </ul>
Airflow up/down direction changes during operation or airflow up/down direction cannot be set.	<ul style="list-style-type: none"> <li>■ During cool mode, the vanes automatically move to the horizontal (down) position after 1 hour when the down (horizontal) airflow up/down direction is selected. This is to prevent water from forming and dripping from the vanes.</li> <li>■ During heat mode, the vanes automatically move to the horizontal airflow up/down direction when the airflow temperature is low or during defrosting mode.</li> </ul>
When the airflow up/down direction is changed, the vanes always move up and down past the set position before finally stopping at the position.	<ul style="list-style-type: none"> <li>■ When the airflow up/down direction is changed, the vanes move to the set position after detecting the base position.</li> </ul>
A flowing water sound or occasional hissing sound is heard.	<ul style="list-style-type: none"> <li>■ These sounds can be heard when refrigerant is flowing in the air conditioner or when the refrigerant flow is changing.</li> </ul>
A cracking or creaking sound is heard.	<ul style="list-style-type: none"> <li>■ These sounds can be heard when parts rub against each due to expansion and contraction from temperature changes.</li> </ul>
The room has an unpleasant odor.	<ul style="list-style-type: none"> <li>■ The indoor unit draws in air that contains gases produced from the walls, carpeting, and furniture as well as odors trapped in clothing, and then blows this air back into the room.</li> </ul>
A white mist or vapor is emitted from the indoor unit.	<ul style="list-style-type: none"> <li>■ If the indoor temperature and the humidity are high, this condition may occur when operation starts.</li> <li>■ During defrosting mode, cool airflow may blow down and appear like a mist.</li> </ul>
Water or vapor is emitted from the outdoor unit.	<ul style="list-style-type: none"> <li>■ During cool mode, water may form and drip from the cool pipes and joints.</li> <li>■ During heat mode, water may form and drip from the heat exchanger.</li> <li>■ During defrosting mode, water on the heat exchanger evaporates and water vapor may be emitted.</li> </ul>
The air conditioner does not operate even though the ON/OFF button is pressed. The operation mode display on the remote controller disappears.	<ul style="list-style-type: none"> <li>■ Is the power switch of the indoor unit turned off? Turn on the power switch.</li> </ul>
"  appears in the remote controller display.	<ul style="list-style-type: none"> <li>■ During central control, " appears in the remote controller display and air conditioner operation cannot be started or stopped using the remote controller.</li> </ul>
When restarting the air conditioner soon after stopping it, it does not operate even though the ON/OFF button is pressed.	<ul style="list-style-type: none"> <li>■ Wait approximately three minutes. (Operation has stopped to protect the air conditioner.)</li> </ul>
Air conditioner operates without the ON/OFF button being pressed.	<ul style="list-style-type: none"> <li>■ Is the on timer set? Press the ON/OFF button to stop operation.</li> <li>■ Is the air conditioner connected to a central remote controller? Consult the concerned people who control the air conditioner.</li> <li>■ Does " appear in the remote controller display? Consult the concerned people who control the air conditioner.</li> <li>■ Has the auto recovery feature from power failures been set? Press the ON/OFF button to stop operation.</li> </ul>
Air conditioner stops without the ON/OFF button being pressed.	<ul style="list-style-type: none"> <li>■ Is the off timer set? Press the ON/OFF button to restart operation.</li> <li>■ Is the air conditioner connected to a central remote controller? Consult the concerned people who control the air conditioner.</li> <li>■ Does " appear in the remote controller display? Consult the concerned people who control the air conditioner.</li> </ul>
Remote controller timer operation cannot be set.	<ul style="list-style-type: none"> <li>■ Are timer settings invalid? If the timer can be set,  or  appears in the remote controller display.</li> </ul>
"PLEASE WAIT" appears in the remote controller display.	<ul style="list-style-type: none"> <li>■ The initial settings are being performed. Wait approximately 3 minutes.</li> </ul>
An error code appears in the remote controller display.	<ul style="list-style-type: none"> <li>■ The protection devices have operated to protect the air conditioner.</li> <li>■ Do not attempt to repair this equipment by yourself. Turn off the power switch immediately and consult your dealer. Be sure to provide the dealer with the model name and information that appeared in the remote controller display.</li> </ul>
Draining water or motor rotation sound is heard.	<ul style="list-style-type: none"> <li>■ When cooling operation stops, the drain pump operates and then stops. Wait approximately 3 minutes.</li> </ul>
(For PLFY-VFM) The vanes do not move or the indoor unit does not respond to input from the wireless remote controller.	<ul style="list-style-type: none"> <li>■ The junction wire connectors of the vane motor and signal receiver may not be connected correctly. Have an installer check the connections. (The colors of the male and female sections of the junction wire connectors must match.)</li> </ul>



## 7. Troubleshooting

Having trouble?	Here is the solution. (Unit is operating normally.)												
Noise is louder than specifications.	<ul style="list-style-type: none"> <li>The indoor operation sound level is affected by the acoustics of the particular room as shown in the following table and will be higher than the noise specification, which was measured in an echo-free room.</li> </ul> <table border="1"> <thead> <tr> <th></th> <th>High sound-absorbing rooms</th> <th>Normal rooms</th> <th>Low sound-absorbing rooms</th> </tr> </thead> <tbody> <tr> <td>Location examples</td> <td>Broadcasting studio, music room, etc.</td> <td>Reception room, hotel lobby, etc.</td> <td>Office, hotel room</td> </tr> <tr> <td>Noise levels</td> <td>3 to 7 dB</td> <td>6 to 10 dB</td> <td>9 to 13 dB</td> </tr> </tbody> </table>		High sound-absorbing rooms	Normal rooms	Low sound-absorbing rooms	Location examples	Broadcasting studio, music room, etc.	Reception room, hotel lobby, etc.	Office, hotel room	Noise levels	3 to 7 dB	6 to 10 dB	9 to 13 dB
	High sound-absorbing rooms	Normal rooms	Low sound-absorbing rooms										
Location examples	Broadcasting studio, music room, etc.	Reception room, hotel lobby, etc.	Office, hotel room										
Noise levels	3 to 7 dB	6 to 10 dB	9 to 13 dB										
Nothing appears in the wireless remote controller display, the display is faint, or signals are not received by the indoor unit unless the remote controller is close.	<ul style="list-style-type: none"> <li>The batteries are low. Replace the batteries and press the Reset button.</li> <li>If nothing appears even after the batteries are replaced, make sure that the batteries are installed in the correct directions (+, -).</li> </ul>												
The operation lamp near the receiver for the wireless remote controller on the indoor unit is flashing.	<ul style="list-style-type: none"> <li>The self diagnosis function has operated to protect the air conditioner.</li> <li>Do not attempt to repair this equipment by yourself. Turn off the power switch immediately and consult your dealer. Be sure to provide the dealer with the model name.</li> </ul>												
Warm air blows from the indoor unit intermittently when heat mode is off or during fan mode.	<ul style="list-style-type: none"> <li>When another indoor unit is operating in heat mode, the control valve opens and closes occasionally to maintain stability in the air conditioning system. This operation will stop after a while. <ul style="list-style-type: none"> <li>* If this will cause an undesirable rise in the room temperature in small rooms, etc., stop the operation of the indoor unit temporarily.</li> </ul> </li> </ul>												
The wireless remote controller does not operate (the indoor unit beeps 4 times).	<ul style="list-style-type: none"> <li>Switch the auto mode setting to the AUTO (single set point) mode or AUTO (dual set point) mode. For details, refer to the included Notice (A5 sheet) or the Installation Manual.</li> </ul>												

### Range of application

The range of working temperatures for both the indoor and outdoor units of the series Y, R2, Multi-S is as below.

### ⚠ Warning:

If the air conditioner operates but does not cool or heat (depending on model) the room, consult your dealer since there may be a refrigerant leak. Be sure to ask the service representative whether there is refrigerant leakage or not when repairs are carried out.

The refrigerant charged in the air conditioner is safe. Refrigerant normally does not leak, however, if refrigerant gas leaks indoors, and comes into contact with the fire of a fan heater, space heater, stove, etc., harmful substances will be generated.

## 8. Specifications

Model	PLFY-P15VFM-E1	PLFY-P20VFM-E1	PLFY-P25VFM-E1	PLFY-P32VFM-E1	PLFY-P40VFM-E1	PLFY-P50VFM-E1
Power source (Voltage/Frequency) <V/Hz>	~N/220-230-240/50, 220/60					
Capacity (Cooling/Heating) <kW>	1.7/1.9	2.2/2.5	2.8/3.2	3.6/4.0	4.5/5.0	5.6/6.3
Dimension (Height) <mm>	245 (10)					
Dimension (Width) <mm>	570 (625)					
Dimension (Depth) <mm>	570 (625)					
Net weight <kg>	14 (3)			15 (3)		
Fan Airflow volume (Low-Middle-High) <m <sup>3</sup> /min>	6.5-7.5-8.0	6.5-7.5-8.5	6.5-8.0-9.0	7.0-8.0-9.5	7.5-9.0-11.0	9.0-11.0-13.0
Noise level (Low-Middle-High) <dB>	26-28-30	26-29-31	26-30-33	26-30-34	28-33-39	33-39-43

### Notes

\* Operation temperature of indoor unit.  
Cooling mode: 15°C WB - 24°C WB  
Heating mode: 15°C DB - 27°C DB

\*1 Cooling/Heating capacity indicates the maximum value at operation under the following condition.  
Cooling: Indoor 27 °C DB/19 °C WB, Outdoor 35 °C DB  
Heating: Indoor 20 °C DB, Outdoor 7 °C DB/6 °C WB

\*2 This figure ( ) indicates panel's.