

HITACHI

Inspire the Next

PM

NO. 0000E

SERVICE MANUAL

TECHNICAL INFORMATION

RAD-18RPA
RAD-25RPA / RAC-25NPA
RAD-35RPA / RAC-35NPA
RAD-50RPA / RAC-50NPA

FOR SERVICE PERSONNEL ONLY

REFER TO THE FOUNDATION MANUAL

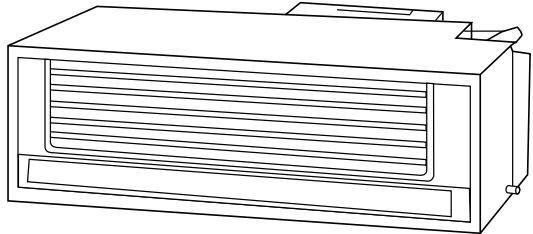

RAD-18RPA
 RAD-25RPA
 RAD-35RPA
 RAD-50RPA

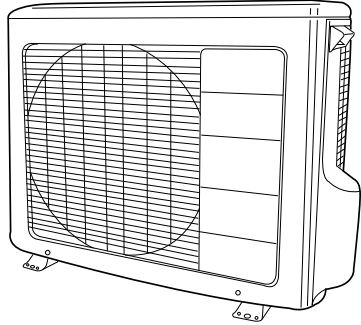
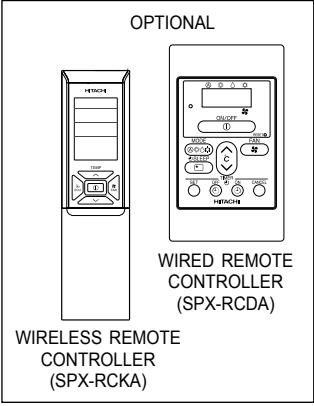

RAC-25NPA
 RAC-35NPA
 RAC-50NPA

CONTENTS

SPECIFICATIONS----- 5

HOW TO USE ----- 7

CONSTRUCTION AND DIMENSIONAL DIAGRAM-----52

MAIN PARTS COMPONENT -----55

WIRING DIAGRAM -----57

CIRCUIT DIAGRAM -----59

BLOCK DIAGRAM -----67

BASIC MODE -----73

REFRIGERATING CYCLE DIAGRAM-----87

DESCRIPTION OF MAIN CIRCUIT OPERATION-----89

SERVICE CALL Q & A----- 120

PARTS LIST AND DIAGRAM----- 148

SPECIFICATIONS

TYPE		DC INVERTER (WALL TYPE)							
		INDOOR UNIT		INDOOR UNIT	OUTDOOR UNIT	INDOOR UNIT	OUTDOOR UNIT	INDOOR UNIT	OUTDOOR UNIT
MODEL		RAD-18RPA		RAD-25RPA	RAC-25NPA	RAD-35RPA	RAC-35NPA	RAD-50RPA	RAC-50NPA
POWER SOURCE		1 PHASE, 50Hz, 220-240V		1 PHASE, 50Hz, 220-240V		1 PHASE, 50Hz, 220-240V		1 PHASE, 50Hz, 220-240V	
COOLING	TOTAL INPUT (W)	560 (155-850)		695 (155-1,050)		1,240 (155-1,280)		2,000 (155-2,060)	
	TOTAL AMPERES (A)	2.56~2.35		3.19~2.93		5.69~5.22		9.10~8.37	
	CAPACITY	(kW)	1.80 (0.9 ~ 2.5)		2.50 (0.9 ~ 3.0)		3.50 (0.9 ~ 4.0)		5.0 (0.9 ~ 5.6)
(B.T.U./h)		6,150 (3,070-8,540)		8,540 (3,070-10,240)		11,950 (3,070-13,660)		17,070 (3,070-19,120)	
HEATING	TOTAL INPUT (W)	690 (155-1,050)		970 (155-1,400)		1,700 (155-1,920)		2,300 (155-2,530)	
	TOTAL AMPERES (A)	3.20-2.92		4.45-4.08		7.81-7.15		9.87-9.05	
	CAPACITY	(kW)	2.50 (0.9 ~ 3.2)		3.50 (0.9 ~ 5.0)		4.80 (0.9 ~ 6.6)		6.0 (0.9 ~ 7.5)
(B.T.U./h)		8,540 (3,070-10,930)		11,950 (3,070-17,070)		16,390 (3,070-22,530)		20,490 (3,070-25,610)	
DIMENSIONS (mm)	W	750		750	750	750	750	750	850
	H	235		235	570	235	570	235	650
	D	400		400	280	400	280	400	298
NET WEIGHT (kg)		16		16	38	16	38	16	45

SPECIFICATIONS AND PARTS ARE SUBJECT TO CHANGE FOR IMPROVEMENT

ROOM AIR CONDITIONER

INDOOR UNIT + OUTDOOR UNIT

SAFETY DURING REPAIR WORK

1. In order to disassemble and repair the unit in question, be sure to disconnect the power cord plug from the power outlet before starting the work.

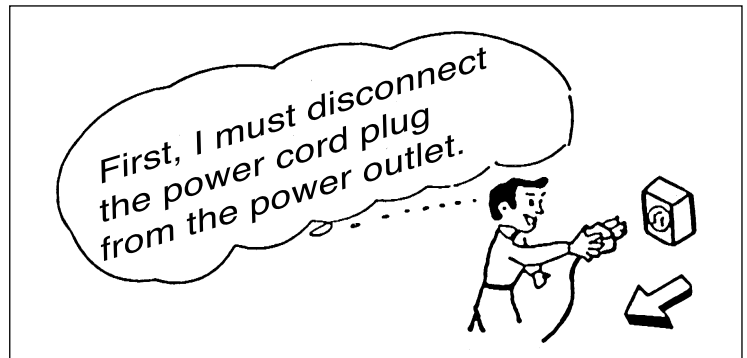

2. If it is necessary to replace any parts, they should be replaced with respective genuine parts for the unit, and the replacement must be effected in correct manner according to the instructions in the Service Manual of the unit.

If the contacts of electrical parts are defective, replace the electrical parts without trying to repair them.

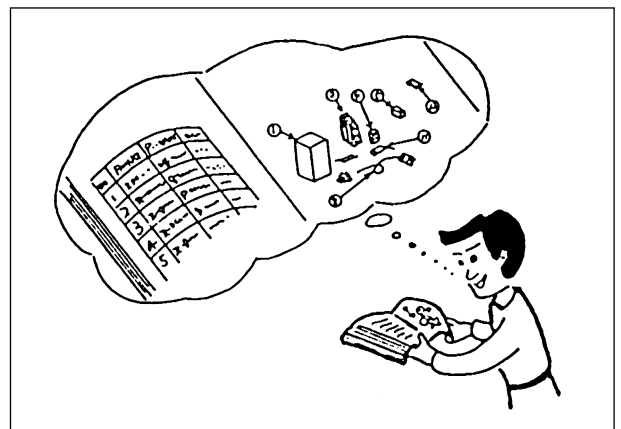

3. After completion of repairs, the initial state should be restored.
4. Lead wires should be connected and laid as in the initial state.
5. Modification of the unit by user himself should absolutely be prohibited.
6. Tools and measuring instruments for use in repairs or inspection should be accurately calibrated in advance.
7. In installing the unit having been repaired, be careful to prevent the occurrence of any accident such as electrical shock, leak of current, or bodily injury due to the drop of any part.
8. To check the insulation of the unit, measure the insulation resistance between the power cord plug and grounding terminal of the unit. The insulation resistance should be $1M\Omega$ or more as measured by a 500V DC megger.
9. The initial location of installation such as window, floor or the other should be checked for being and safe enough to support the repaired unit again. If it is found not so strong and safe, the unit should be installed at the initial location reinforced or at a new location.
10. Any inflammable thing should never be placed about the location of installation.
11. Check the grounding to see whether it is proper or not, and if it is found improper, connect the grounding terminal to the earth.



WORKING STANDARDS FOR PREVENTING BREAKAGE OF SEMICONDUCTORS

1. Scope

The standards provide for items to be generally observed in carrying and handling semiconductors in relative manufacturers during maintenance and handling thereof. (They apply the same to handling of abnormal goods such as rejected goods being returned).

2. Object parts

- (1) Micro computer
- (2) Integrated circuits (IC)
- (3) Field-effect transistors (FET)
- (4) P.C. boards or the like on which the parts mentioned in (1) and (2) of this paragraph are equipped.

3. Items to be observed in handling

- (1) Use a conductive container for carrying and storing of parts. (Even rejected goods should be handled in the same way).

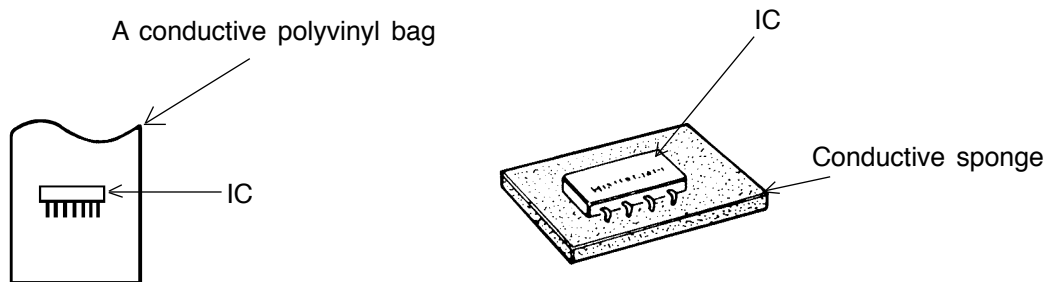

Fig. 1. Conductive Container

- (2) When any part is handled uncovered (in counting, packing and the like), the handling person must always use himself as a body earth. (Make yourself a body earth by passing $1M\Omega$ earth resistance through a ring or bracelet).
- (3) Be careful not to touch the parts with your clothing when you hold a part even if a body earth is being taken.
- (4) Be sure to place a part on a metal plate with grounding.
- (5) Be careful not to fail to turn off power when you repair the printed circuit board. At the same time, try to repair the printed circuit board on a grounded metal plate.

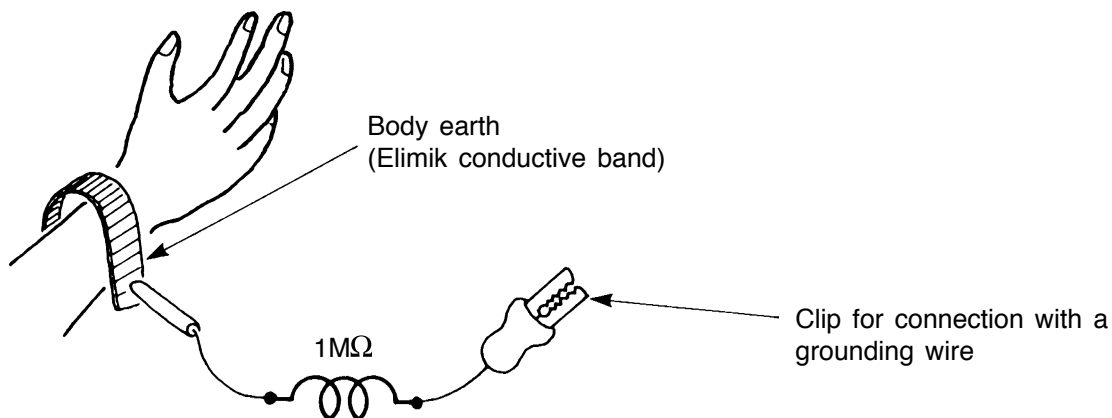

Fig. 2. Body Earth

(6) Use a three wire type soldering iron including a grounding wire.

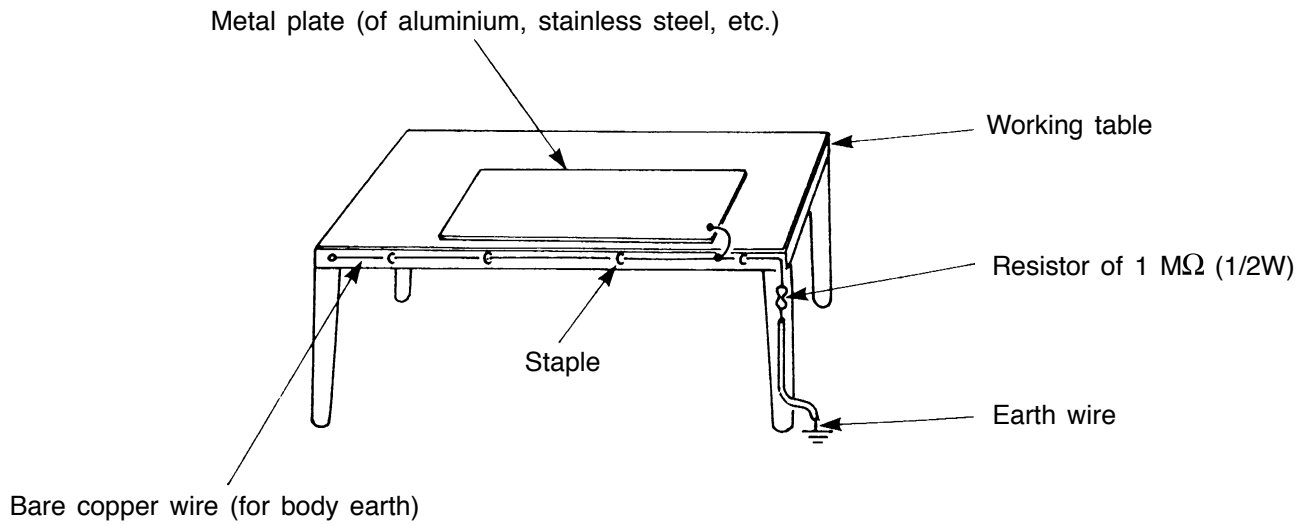

Fig. 3. Grounding of the working table

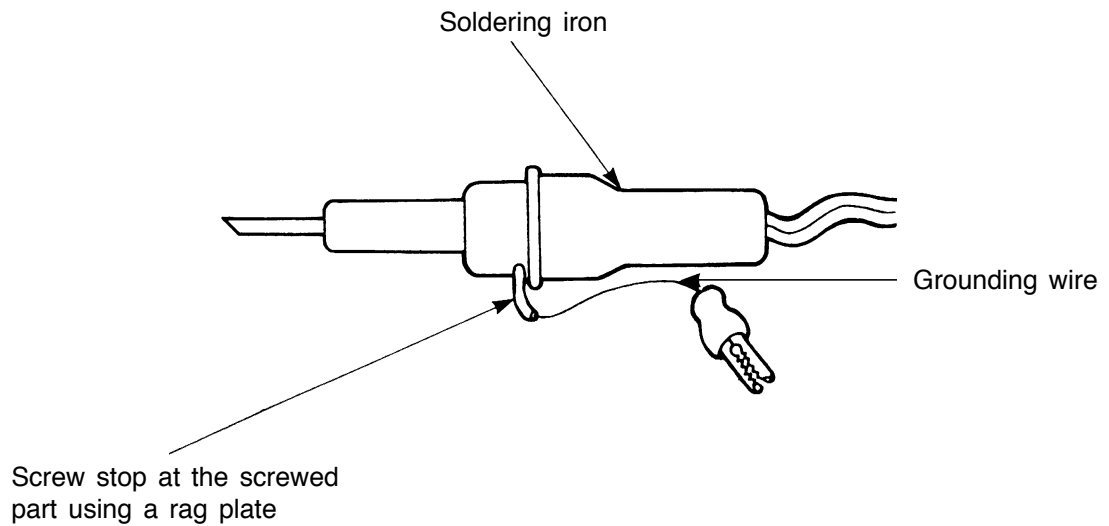

Fig. 4. Grounding a soldering iron

Use a high insulation mode (100V, 10MΩ or higher) when ordinary iron is to be used.

(7) In checking circuits for maintenance, inspection or some others, be careful not to have the test probes of the measuring instrument shortcircuit a load circuit or the like.

 **CAUTION**

1. In quiet operation or stopping the running, slight flowing noise of refrigerant in the refrigerating cycle is heard occasionally, but this noise is not abnormal for the operation.
2. When it thunders near by, it is recommend to stop the operation and to disconnect the power cord plug from the power outlet for safety.
3. The room air conditioner does not start automatically after recovery of the electric power failure for preventing fuse blowing. Re-press START/STOP button after 3 minutes from when unit stopped.
4. If the room air conditioner is stopped by adjusting thermostat, or missoperation, and re-start in a moment, there is occasion that the cooling and heating operation does not start for 3 minutes, it is not abnormal and this is the result of the operation of IC delay circuit. This IC delay circuit ensures that there is no danger of blowing fuse or damaging parts even if operation is restarted accidentally.
5. This room air conditioner should not be used at the cooling operation when the outside temperature is below 10°C (50°F).
6. This room air conditioner (the reverse cycle) should not be used when the outside temperature is below -15°C (5°F).
If the reverse cycle is used under this condition, the outside heat exchanger is frosted and efficiency falls.
7. When the outside heat exchanger is frosted, the frost is melted by operating the hot gas system, it is not trouble that at this time fan stops and the vapour may rise from the outside heat exchanger.

SPECIFICATIONS

MODEL		RAD-18RPA RAD-25RPA RAD-35RPA RAD-50RPA	RAC-25NPA RAC-35NPA	RAC-50NPA
FAN MOTOR		20W	40 W	
FAN MOTOR CAPACITOR		NO	NO	
FAN MOTOR PROTECTOR		NO	NO	
COMPRESSOR		–	JU1012D	JU1013D
COMPRESSOR MOTOR CAPACITOR		NO	NO	
OVERLOAD PROTECTOR		NO	YES	
OVERHEAT PROTECTOR		NO	YES	
FUSE (for MICROPROCESSOR)		YES(IC)	3.0A	
POWER RELAY		NO	G4A	
POWER SWITCH		NO	NO	
TEMPORARY SWITCH		YES	NO	
SERVICE SWITCH		NO	YES	
TRANSFORMER		NO	NO	
VARISTOR		NO	450NR	
NOISE SUPPRESSOR		NO	YES	
THERMOSTAT		YES(IC)	YES(IC)	
REMOTE CONTROL SWITCH (LIQUID CRYSTAL)		YES	NO	
REFRIGERANT CHARGING VOLUME (Refrigerant 410A)	UNIT	-----	1150g	1400g
	PIPES (MAX. 20m)	WITHOUT REFRIGERANT BECAUSE COUPLING IS FLARE TYPE.		

[Indoor unit installation]

CAUTION

Always install the indoor unit at level. If the indoor unit is inclined, water may leak.

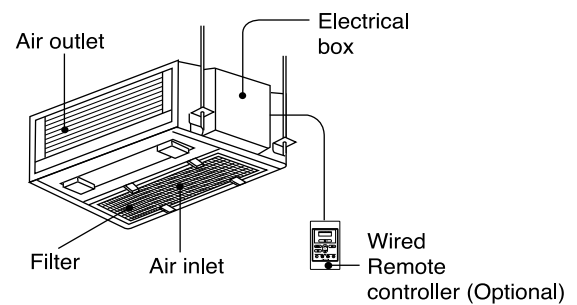
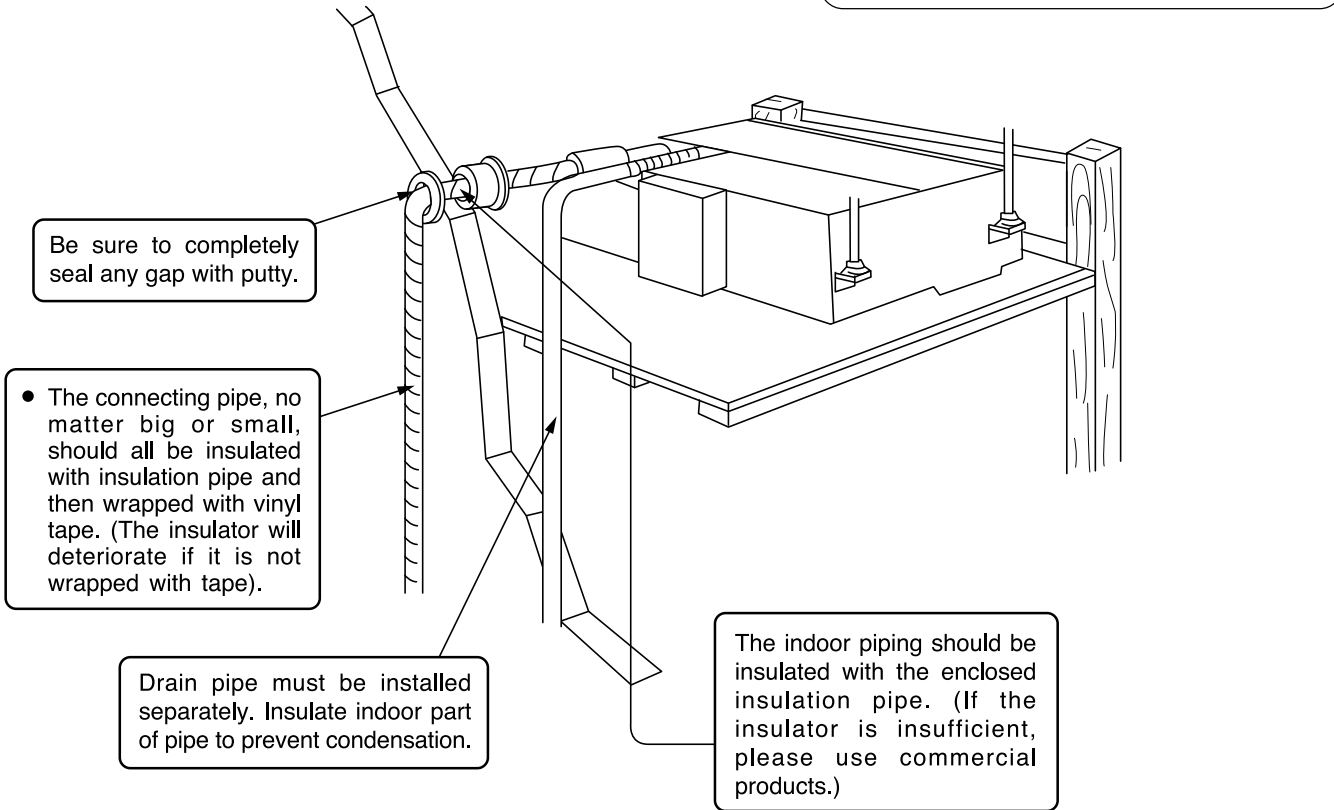



- “Height difference” and “Piping length” of Indoor and Outdoor unit are different by Outdoor unit. Please refer to the installation manual in Outdoor unit.





SAFETY PRECAUTION

- Please read the “Safety Precaution” carefully before operating the unit to ensure correct usage of the unit.
- Pay special attention to signs of “**▲ Warning**” and “**▲ Caution**”. The “Warning” section contains matters which, if not observed strictly, may cause death or serious injury. The “Caution” section contains matters which may result in serious consequences if not observed properly. Please observe all instructions strictly to ensure safety.
- The sign indicate the following meanings.

 Make sure to connect earth line.	 The sign in the figure indicates prohibition.
 Indicates the instructions that must be followed.	

- Please keep this manual after reading.





PRECAUTIONS DURING INSTALLATION

WARNING	<ul style="list-style-type: none"> ● Do not reconstruct the unit. Water leakage, fault, short circuit or fire may occur if you reconstruct the unit by yourself. 	
	<ul style="list-style-type: none"> ● Please ask your sales agent or qualified technician for the installation of your unit. Water leakage, short circuit or fire may occur if you install the unit by yourself. 	
	<ul style="list-style-type: none"> ● Please use earth line. Do not place the earth line near water or gas pipes, lightning-conductor, or the earth line of telephone. Improper installation of earth line may cause electric shock. 	
CAUTION	<ul style="list-style-type: none"> ● A circuit breaker should be installed depending on the mounting site of the unit. Without a circuit breaker, the danger of electric shock exists. 	
	<ul style="list-style-type: none"> ● Do not install near location where there is flammable gas. The outdoor unit may catch fire if flammable gas leaks around it. 	
	<ul style="list-style-type: none"> ● Please ensure smooth flow of water when installing the drain hose. 	

PRECAUTIONS DURING SHIFTING OR MAINTENANCE

WARNING	<ul style="list-style-type: none"> ● Should abnormal situation arises (like burning smell), please stop operating the unit and turn off the circuit breaker. Contact your agent. Fault, short circuit or fire may occur if you continue to operate the unit under abnormal situation. 	
	<ul style="list-style-type: none"> ● Please contact your agent for maintenance. Improper self maintenance may cause electric shock and fire. 	
	<ul style="list-style-type: none"> ● Please contact your agent if you need to remove and reinstall the unit. Electric shock or fire may occur if you remove and reinstall the unit yourself improperly. 	
	<ul style="list-style-type: none"> ● If the supply cord is damaged, it must be replaced by the special cord obtainable at authorized service/parts centers. 	

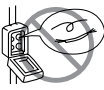
PRECAUTIONS DURING OPERATION

WARNING	<ul style="list-style-type: none"> ● Avoid an extended period of direct air flow for your health. 	
	<ul style="list-style-type: none"> ● Do not insert a finger, a rod or other objects into the air outlet or inlet. As the fan is rotating at a high speed, it will cause injury. Before cleaning, be sure to stop the operation and turn the breaker OFF. 	
	<ul style="list-style-type: none"> ● Do not use any conductor as fuse wire, this could cause fatal accident. 	
	<ul style="list-style-type: none"> ● During thunder storm, disconnect and turn off the circuit breaker. 	

PRECAUTIONS DURING OPERATION

- The product shall be operated under the manufacturer specification and not for any other intended use.

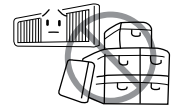

- Do not attempt to operate the unit with wet hands, this could cause fatal accident.

- When operating the unit with burning equipments, regularly ventilate the room to avoid oxygen insufficiency.

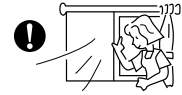

- Do not direct the cool air coming out from the air-conditioner panel to face household heating apparatus as this may affect the working of apparatus such as the electric kettle, oven etc.

- Please ensure that outdoor mounting frame is always stable, firm and without defect. If not, the outdoor unit may collapse and cause danger.



- Do not splash or direct water to the body of the unit when cleaning it as this may cause short circuit.

- Do not use any aerosol or hair sprays near the indoor unit. This chemical can adhere on heat exchanger fin and blocked the evaporation water flow to drain pan. The water will drop on tangential fan and cause water splashing out from indoor unit.

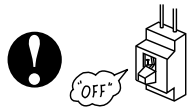

- Please switch off the unit and turn off the circuit breaker during cleaning, the high-speed fan inside the unit may cause danger.

- Turn off the circuit breaker if the unit is not to be operated for a long period.

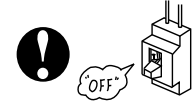

- Do not climb on the outdoor unit or put objects on it.

- Do not put water container (like vase) on the indoor unit to avoid water dripping into the unit. Dripping water will damage the insulator inside the unit and causes short-circuit.

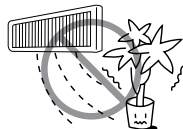

- Do not place plants directly under the air flow as it is bad for the plants.

- When operating the unit with the door and windows opened, (the room humidity is always above 80%) and with the air deflector facing down or moving automatically for a long period of time, water will condense on the air deflector and drips down occasionally. This will wet your furniture. Therefore, do not operate under such condition for a long time.
- If the amount of heat in the room is above the cooling or heating capability of the unit (for example: more people entering the room, using heating equipments and etc.), the preset room temperature cannot be achieved.

- This appliance is not intended for use by young children or infirm persons unless they have been adequately supervised by a responsible person to ensure that they can use the appliance safely.
- Young children should be supervised to ensure that they do not play with the appliance.



C
A
U
T
I
O
N

MULTI-AIR CONDITIONER

With this multi-air conditioner, several indoor units can be connected to one outdoor unit to be driven. You can operate the required number of indoor units.

Combination of Operations:

When operation mode is selected:

- You cannot operate the indoor units in the following combinations.

One unit	Other unit
Heating	Cooling
	Dehumidifying
	Circulating (fan)

- The indoor unit which is switched on first continues to operate, but other indoor units which is switched on later does not operate while the lamp lights.
- To re-start an indoor unit which was operated later, stop the indoor unit which was operated first or later and reset the type of operation, then perform operation again.

During automatic operation:

- When heating operation is automatically selected for the first indoor unit, the next indoor unit will then start to heat. Also, if cooling or dehumidifying is automatically selected for the first indoor unit, the next indoor unit will also start to cool or dehumidify.

Adjusting the Number of Indoor Units:

Decrease the number of indoor units to be operated especially when it is very hot or cold or when you want to reach the present temperature quickly.

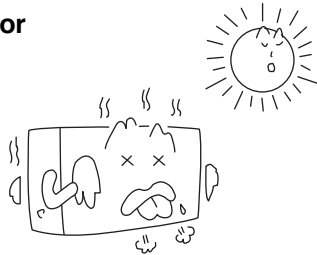

Stopped Indoor Units:

When an indoor unit is operated in the cooling, heating or dehumidifying mode in the room, the sound of refrigerant flow may be heard from a stopped indoor unit or a stopped indoor unit may become warm. This is because the indoor unit returns refrigerant to the outdoor unit to be ready for operation.

NAMES AND FUNCTIONS OF EACH PART

INDOOR UNIT

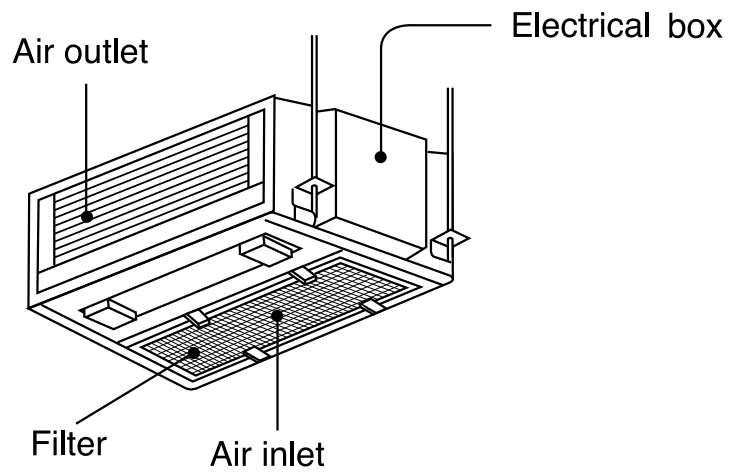

MODEL NAME AND DIMENSIONS

MODEL	WIDTH (mm)	HEIGHT (mm)	DEPTH (mm)
RAD-18RPA/RAD-25RPA/RAD-35RPA/RAD-50RPA	750	235	400

Note

- The recommended temperature range for safety testing should be as below:

		Cooling		Heating	
		Minimum	Maximum	Minimum	Maximum
Indoor	Dry bulb °C	21	32	20	27
	Wet bulb °C	15	23	12	19
Outdoor	Dry bulb °C	21	43	2	21
	Wet bulb °C	15	26	1	15

CIRCUIT BREAKER

When you do not use the room air conditioner, set the circuit breaker to “OFF”.

HOW TO USE THE AIR CONDITIONER EFFECTIVELY

1. An average room temperature setting is probably the best for you as well as being economical.

- Excessive cooling or heating is not recommended for health reasons. High electricity bills may also result.
- Close the curtains or blinds to prevent heat from flowing into or escaping the room as well as to make more effective use of electricity.



2. At intervals, the doors and windows should be opened to let fresh air in.



Make sure the room is ventilated when operating the air conditioner at the same time as other heating appliances.



3. Using the timer is recommended before going to sleep or going out.



4. The following must never be used for cleaning the indoor and outdoor units.

- Benzene, thinner and scrub can damage plastic surfaces or coating.
- Hot water above 40°C can shrink the filter and deform plastic parts.



5. Do not block the air intake and air outlet.

- Do not block the air outlets and intakes of the indoor and outdoor units with curtains or other obstacles which could degrade air conditioner performance and cause unit failure.

THE IDEAL WAYS OF OPERATION

Suitable Room Temperature

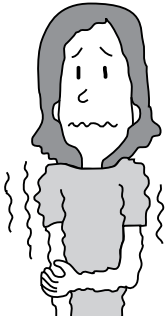

⚠ Warning

Freezing temperature is bad for health and a waste of electric power.

Install curtain or blinds

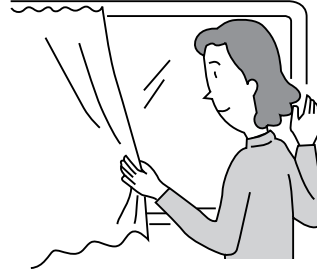

It is possible to reduce heat entering the room through windows.

Ventilation

⚠ Caution

Do not close the room for a long period of time. Occasionally open the door and windows to allow the entrance of fresh air.



Effective Usage Of Timer

At night, please use the “OFF or ON timer operation mode”, together with your wake up time in the morning. This will enable you to enjoy a comfortable room temperature. Please use the timer effectively.

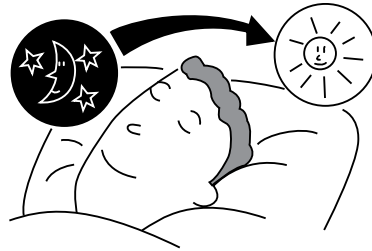

Do Not Forget To Clean The Air Filter

Dusty air filter will reduce the air volume and the cooling efficiency. To prevent from wasting electric energy, please clean the filter every 2 weeks.

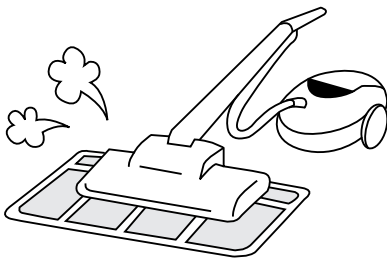

Please Adjust Suitable Temperature For Baby And Children

Please pay attention to the room temperature and air flow direction when operating the unit for baby, children and old folks who have difficulty in movement.

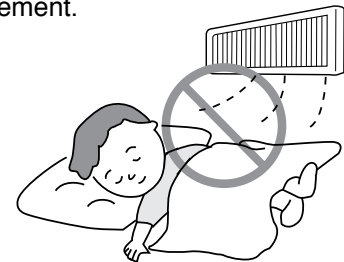

FOR USER'S INFORMATION

The Air Conditioner And The Heat Source In The Room

⚠ Caution

If the amount of heat in the room is above the cooling capability of the air conditioner (for example: more people entering the room, using heating equipments and etc.), the preset room temperature cannot be achieved.

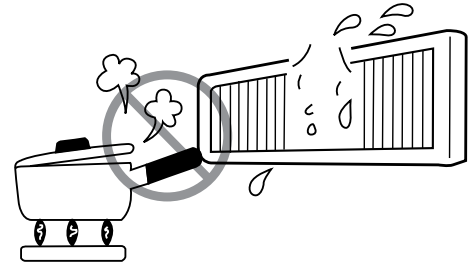

Not Operating For A Long Time

When the indoor unit is not to be used for a long period of time, please switch off the power from the mains. If the power from mains remains "ON", the indoor unit still consumes about 10W in the operation control circuit even if it is in "OFF" mode.

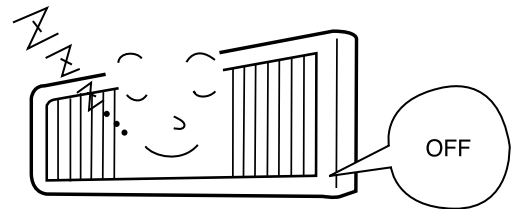

When Lightning Occurs

⚠ Warning

To protect the whole unit during lightning, please stop operating the unit and remove the plug from the socket.

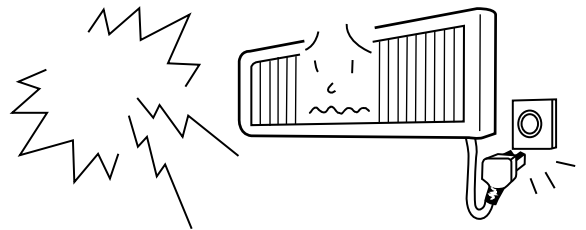

Interference From Electrical Products

⚠ Caution

To avoid noise interference, please place the indoor unit and its remote controller at least 1m away from electrical products.

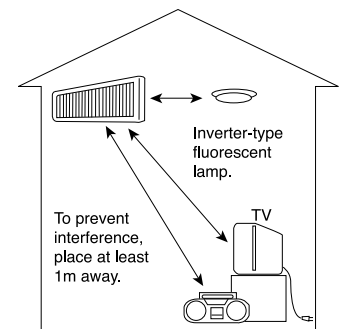

MAINTENANCE

⚠ WARNING

- Before cleaning, stop unit operation with the remote controller and turn off the circuit breaker.

⚠ CAUTION

- Do not expose the unit to water as it may cause an electric shock.
- For cleaning inside the air conditioner, consult your sales agent.
- Avoid using detergent when cleaning the heat exchanger of the indoor unit. Unit failure may result.
- When cleaning the heat exchanger with a vacuum cleaner, make sure to wear gloves so as not to injure your hands on the heat exchanger fins.

1. AIR FILTER

Clean the air filter, as it removes dust inside the room. Be sure to clean the filter once every two weeks so as not to consume electricity unnecessarily.

PROCEDURE

- 1** Pull the filter toward the center until it detached from the holders. Then take it out from holders (refer to diagram).
- 2** Remove dust from the filter using a vacuum cleaner. If there is too much dust, use neutral detergent. After using neutral detergent, wash with clean water and dry in the shade.
- 3** Install the filters.
Gently insert back the filter into the holders.

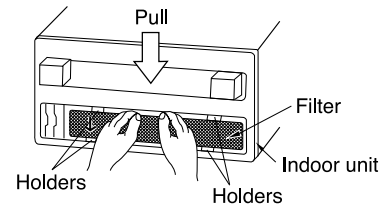
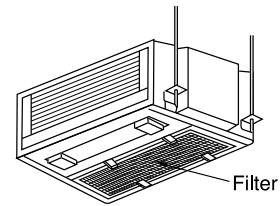

⚠ CAUTION

- Do not wash with hot water at more than 40°C. The filter may shrink.
- When washing it, shake off moisture completely and dry it in the shade; do not expose it directly to the sun. The filter may shrink.
- Do not operate the air conditioner with the filter removed. Dust may enter the air conditioner and cause trouble.

REGULAR INSPECTION

PLEASE CHECK THE FOLLOWING POINTS BY QUALIFIED SERVICE PERSONAL EITHER EVERY HALF YEARLY OR YEARLY. CONTACT YOUR SALES AGENT OR SERVICE SHOP.

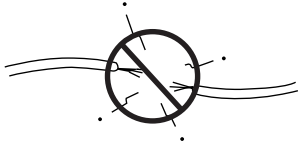
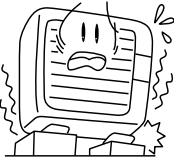
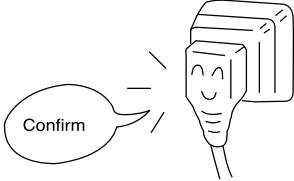
1		Is the earth line disconnected or broken?
2		Is the mounting frame seriously affected by rust and is the outdoor unit tilted or unstable?
3		Is the plug of power line firmly plugged into the socket? (Please ensure no loose contact between them).

AFTER SALE SERVICE AND WARRANTY

WHEN ASKING FOR SERVICE, CHECK THE FOLLOWING POINTS.

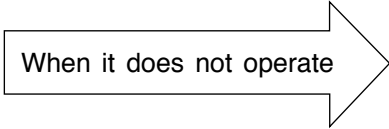
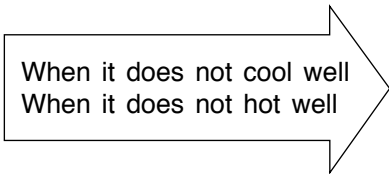
CONDITION	CHECK THE FOLLOWING POINTS
	<ul style="list-style-type: none"> ● Is the fuse all right? ● Is the voltage extremely high or low? ● Is the circuit breaker "ON"?
	<ul style="list-style-type: none"> ● Was the air filter cleaned? ● Does sunlight fall directly on the outdoor unit? ● Is the air flow of the outdoor unit obstructed? ● Are the doors or windows opened, or is there any source of heat in the room? ● Is the set temperature suitable?













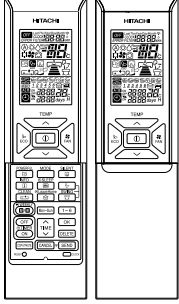







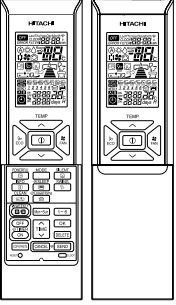







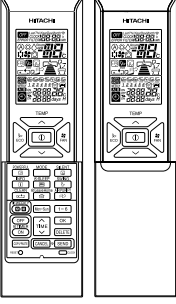







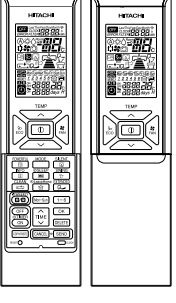



Notes

- In quiet or stop operation, the following phenomena may occasionally occur, but they are not abnormal for the operation.
 - (1) Slight flowing noise of refrigerant in the refrigerating cycle.
 - (2) Slight rubbing noise from the fan casing which is cooled and then gradually warmed as operation stops.
- The odor will possibly be emitted from the room air conditioner because the various odor, emitted by smoke, foodstuffs, cosmetics and so on, sticks to it. So the air filter and the evaporator regularly must be cleaned to reduce the odor.

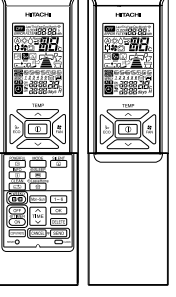
- Please contact your sales agent immediately if the air conditioner still fails to operate normally after the above inspections. Inform your agent of the model of your unit, production number, date of installation. Please also inform him regarding the fault.
- Power supply shall be connected at the rated voltage, otherwise the unit will be broken or could not reach the specified capacity.

PRECAUTIONS FOR USE

- In case of power failure happen, Wired Remote Controller may not show current operating mode when power comes back. However unit will continue to operate at previous setting mode.
- Some features of Wireless Remote Controller are not available when use Wired Remote Controller as mentioned below:

Standard Wireless Remote Controller	Features not available on Wired Remote Controller
<p>RAR-5E1</p> 	<ul style="list-style-type: none"> ● Powerful  ● Information  ● One touch clean  ● Leave home  ● Silent  ● Weekly timer  ● Auto swing (vertical)  ● Auto swing (horizontal) 
<p>RAR-5E2</p> 	<ul style="list-style-type: none"> ● Powerful  ● Information  ● One touch clean  ● Leave home  ● Silent  ● Weekly timer  ● Auto swing (vertical) 
<p>RAR-5E3</p> 	<ul style="list-style-type: none"> ● Powerful  ● Information  ● One touch clean  ● Leave home  ● Silent  ● Weekly timer  ● Auto swing (vertical)  ● Air purify 
<p>RAR-5E4</p> 	<ul style="list-style-type: none"> ● Powerful  ● Information  ● One touch clean  ● Leave home  ● Silent  ● Weekly timer  ● Auto swing (vertical)  ● Extended 
<p>RAR-5E5</p> 	<ul style="list-style-type: none"> ● Powerful  ● Information  ● One touch clean  ● Leave home  ● Silent  ● Weekly timer 

NAMES AND FUNCTIONS OF REMOTE CONTROLLER

■ This controls the operation function and timer setting of the room air conditioner.

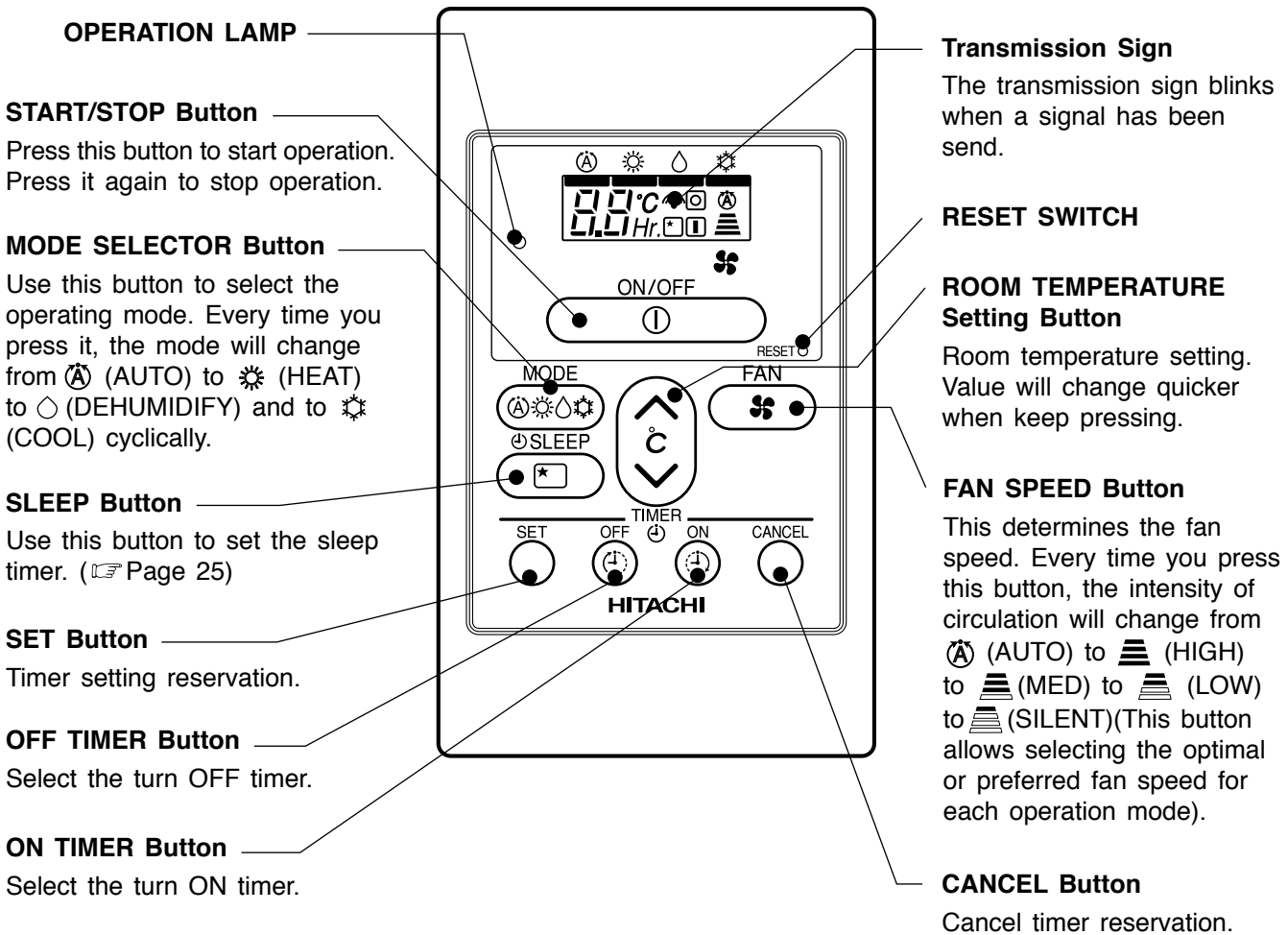

Precautions for Use

- Do not put the remote controller in the following places.
 - Under direct sunlight.
 - In the vicinity of a heater.
- Handle the remote controller carefully. Do not drop it on the floor, and protect it from water.
- Once the outdoor unit stops, it will not restart for about 3 minutes (unless you turn the power switch off and on or unplug the power cord and plug it in again).
This is to protect the device and does not indicate a failure.
- If you press the MODE SELECTOR button during operation, the device may stop for about 3 minutes for protection.

VARIOUS FUNCTIONS

Auto Restart Control

- If there is a power failure, operation will be automatically restarted when the power is resumed with previous operation mode.
(As the operation is not stopped by remote controller.)
- If you intend not to continue the operation when the power is resumed, switch off the power supply. When you switch on the circuit breaker, the operation will be automatically restarted with previous operation mode.

Note: 1. If you do not require Auto Restart Control, please consult your sales agent.
2. Auto Restart Control is not available when Timer or Sleep Timer mode is set.

AUTOMATIC OPERATION

The device will automatically determine the mode of operation, HEAT or COOL depending on the current room temperature. The selected mode of operation will change when the room temperature varies.

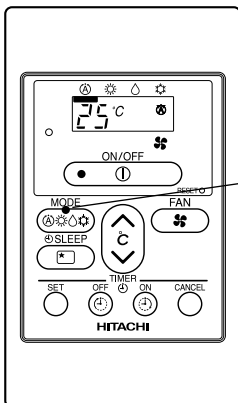

1

Press the MODE selector button so that the display indicates the (AUTO) mode of operation.

- When AUTO has been selected, the device will automatically determine the mode of operation, HEAT or COOL depending on the current room temperature. However the mode of operation will not change when indoor unit is connected to multi type outdoor unit.
- If the mode automatically selected by the unit is not satisfactory, manually change the mode setting (HEAT, DEHUMIDIFY or COOL).

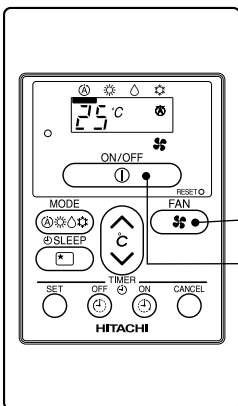

2

Press the (FAN SPEED) button to select AUTO, HIGH, MED, LOW or SILENT.

Set the desired FAN SPEED with the (FAN SPEED) button (the display indicates the setting).

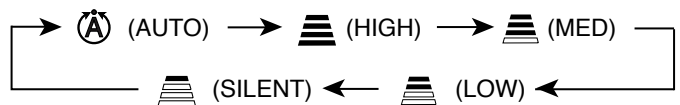

**START
STOP**

Press the (START/STOP) button.
Operation starts.
Press the button again to stop operation.

- As the settings are stored in the memory in the remote controller, you only have to press the (START/STOP) button next time.

HEATING OPERATION

- Use the device for heating when the outdoor temperature is under 21°C.
When it is too warm (over 21°C), the heating function may not work in order to protect the device.
- In order to maintain reliability of the device, please use this device when outdoor temperature is above -15°C

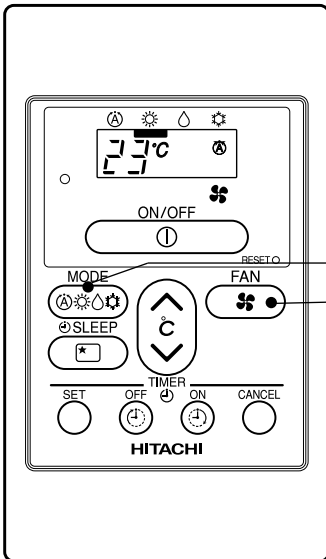

1

Press the MODE SELECTOR button so that the display indicates ☀ (HEAT).

Set the desired FAN SPEED with the 🌀 (FAN SPEED) button (the display indicates the setting).

2



Set the desired room temperature with the ROOM TEMPERATURE setting button (the display indicates the setting).

3

The temperature setting and the actual room temperature may vary depending on conditions.

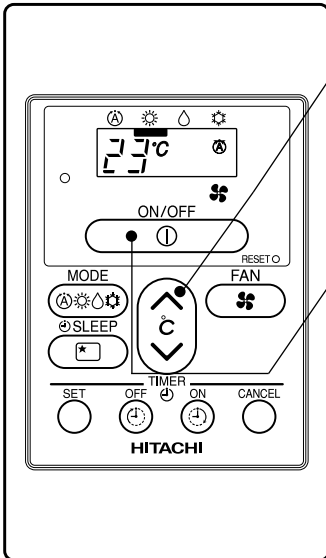

**START
STOP**

Press the ⏻ (START/STOP) button. Heating operation starts. Press the button again to stop operation.

- As the settings are stored in the memory of the remote controller, you only have to press the ⏻ (START/STOP) button next time.
- During AUTO fan, the fan speed automatically changes as below:
 - When the difference between room temperature and setting temperature is large, fan starts to run at HI speed.
 - After room temperature reaches the preset temperature, fan speed will be changed to lower speed to obtain optimum room temperature condition for natural healthy heating.

Defrosting

Defrosting will be performed about once an hour when frost forms on the heat exchange of the outdoor unit, for 5~10 minutes each time.
During defrosting operation, the operation lamp blinks in a cycle of 3 seconds on and 0.5 second off.
The maximum time for defrosting is 20 minutes.
However, if the indoor unit is connected to multi type outdoor unit, the maximum time for defrosting is 15 minutes.
(If the piping length used is longer than usual, frost is likely to form.)

DEHUMIDIFYING OPERATION

Use the device for dehumidifying when the room temperature is over 16°C.
When it is under 15°C, the dehumidifying function will not work.

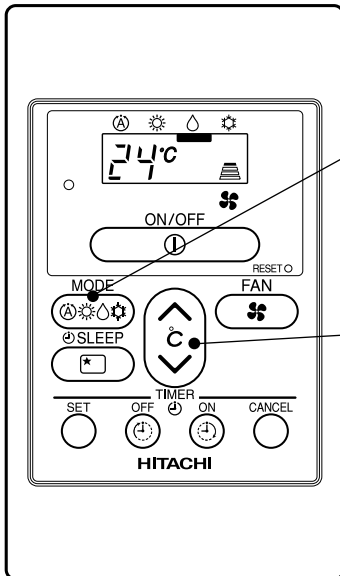

1

Press the MODE SELECTOR button so that the display indicates ◊ (DEHUMIDIFY).
Press  (FAN SPEED) button to select SILENT or LOW fan speed.

2

Set the desired room temperature with the ROOM TEMPERATURE setting button (the display indicates the setting).

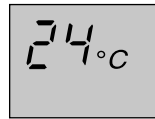

The range of 20-26°C is recommended as the room temperature for dehumidifying.

**START
STOP**

Press the  (START/STOP) button. Dehumidifying operation starts. Press the button again to stop operation.

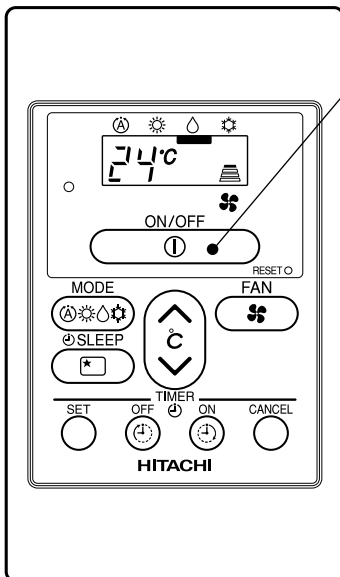

- As the settings are stored in the memory in the remote controller, you only have to press the  (START/STOP) button next time.

■ Dehumidifying Function

- When the room temperature is higher than the temperature setting: The device will dehumidify the room, reducing the room temperature to the preset level.
When the room temperature is lower than the temperature setting: Dehumidifying will be performed at the temperature setting slightly lower than the current room temperature, regardless of the temperature setting.
- The preset room temperature may not be reached depending on the number of people present in the room or other room conditions.

COOLING OPERATION

Use the device for cooling when the outdoor temperature is $-10\sim 43^{\circ}\text{C}$.
 If indoor humidity is very high (80%), some dew may form on the air outlet grille of the indoor unit.

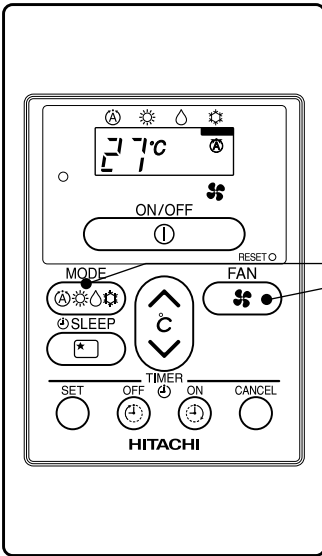

1

Press the MODE SELECTOR button so that the display indicates  (COOL).

2

Set the desired FAN SPEED with the  (FAN SPEED) button (the display indicates the setting).

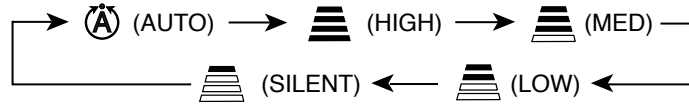



3

Set the desired room temperature with the ROOM TEMPERATURE setting button (the display indicates the setting).

The temperature setting and the actual room temperature may vary depending on conditions.

**START
STOP**

Press the  (START/STOP) button. Cooling operation starts. Press the button again to stop operation. The cooling function does not start if the temperature setting is higher than the current room temperature (even though the  (OPERATION) lamp lights). The cooling function will start as soon as you set the temperature below the current room temperature.

- As the settings are stored in the memory of the remote controller, you only have to press the  (START/STOP) button next time.
- During AUTO fan, the fan speed automatically changes as below:
 - When the difference between room temperature and setting temperature is large, fan starts to run at HI speed.
 - After room temperature reaches the preset temperature, fan speed will be changed to lower speed to obtain optimum room temperature condition for natural healthy cooling.

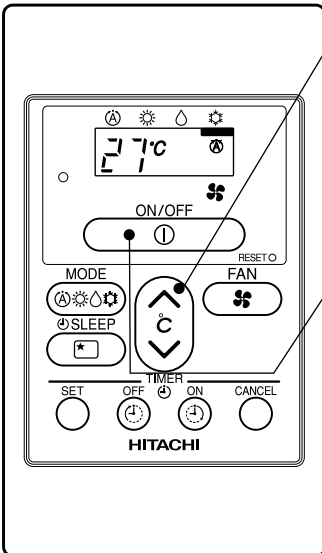





LEAVE HOME(LH) AND CLEAN (ONE TOUCH CLEAN) OPERATIONS

- Leave Home (LH) and CLEAN(One Touch Clean) operations activation buttons are not available on this device. The operations shall be activated by wireless remote controller.
- Please refer to wireless 'Remote Controller Manual' to activate the operations.

NOTE

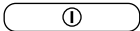
- If  or  is displayed on the wired remote controller display, the unit will operate Leave Home (LH) operation mode or CLEAN (One Touch Clean) which shall be activated by wireless remote controller.
- Push start/stop  button to stop Leave Home (LH) or CLEAN (One Touch Clean) operation.

TIMER RESERVATION

■ ON Timer and OFF Timer are available.

OFF Timer Reservation

1 ⌚ OFF TIMER setting

- Select the OFF TIMER by pressing the ⌚ (OFF) Button.
- Setting timer will change according to the below sequence when you press the button.

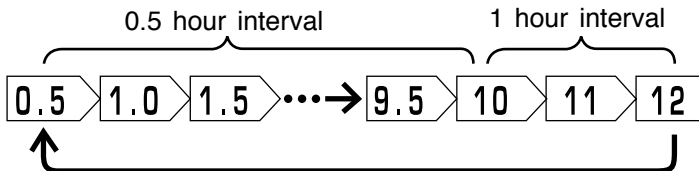

- The value change quicker if you keep pressing the button.

2 Press the ○ (SET) button

- OFF TIMER is reserved.
- The ☐ (OFF) Mark starts lighting instead of blinking.

ON Timer Reservation

1 ⌚ ON TIMER setting

- Select the ON TIMER by pressing the ⌚ (ON) Button.
- At the beginning of setting, timer is set to 6 hours.
- Setting timer will change according to the below sequence.

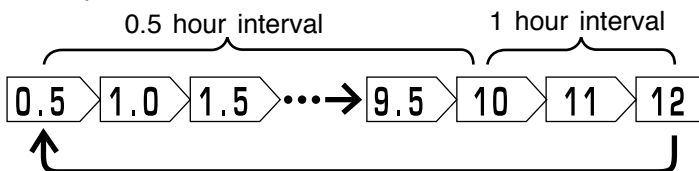

- The value change quicker if you keep pressing the button.

2 Press the ○ (SET) button

- ON TIMER is reserved.
- The □ (ON) Mark starts lighting instead of blinking.

CANCELLATION of Timer Reservation

1 Press the ○ (CANCEL) button

- As the timer settings are stored in remote controller memory, you only have to press the ○ (SET) button in order to use the same setting next time.

■ Operation stop at setting timer

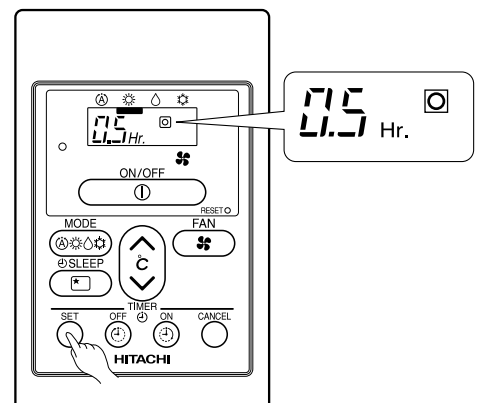
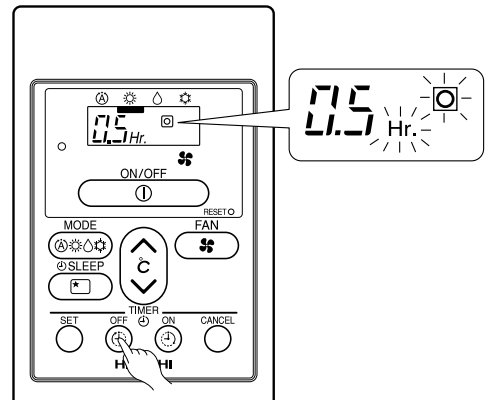

■ Operation will start for setting temperature at setting timer (The starting time may different depend on the room temperature and set temperature).

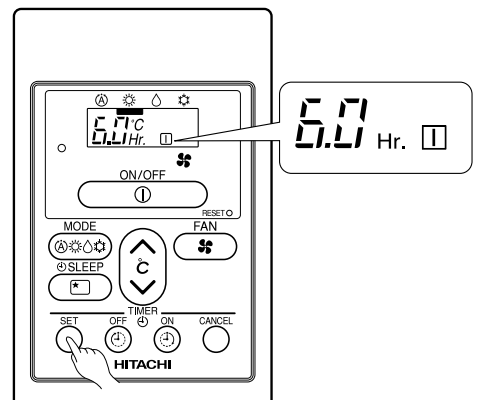
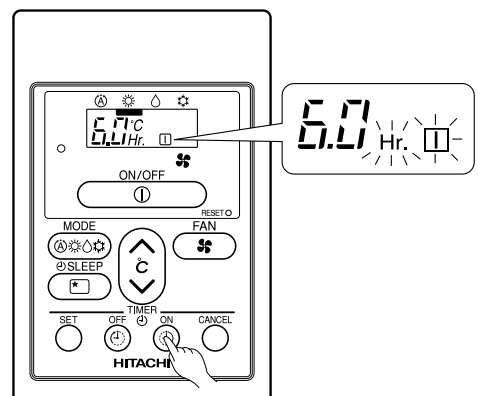

HOW TO SET THE SLEEP TIMER

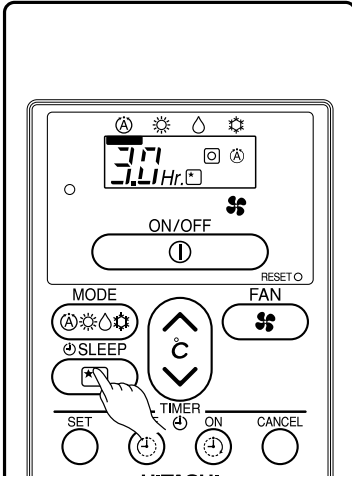

Example: Setting 3 hours sleep timer.

Mode	Indication
Sleep timer	

Sleep Timer: The device will continue working for the designated number of hours and then turn off.
Press the SLEEP button.
The timer information will be displayed on the remote controller.

How to Cancel Reservation

Press the ○ (CANCEL) button. The ◻ and ★ (RESERVED) sign goes out.

Explanation of the sleep timer

The device will control the FAN SPEED and room temperature automatically so as to be quiet and good for people's health.

NOTE

- If you set the sleep timer after the off or on-timer has been set, the sleep timer becomes effective instead of the off or on-timer set earlier.
- You can not set other timer during sleep timer operation.
- After sleep timer time is up and when press sleep button again, the sleep timer will be set as last setting.
- Sleep timer effective only once.

INSTALLATION OF WIRED REMOTE CONTROLLER

- (a) Connection to the electrical box;
- Remove the cover of electric box
 - Connect the connector of wired remote controller to CN1102 of electrical board
 - Assemble back the cover of electrical box
- (b) Wiring installation for wired remote controller (2 methods);
- Wired remote controller casing can be opened by pressing the slots with minus screw driver (see below diagram)

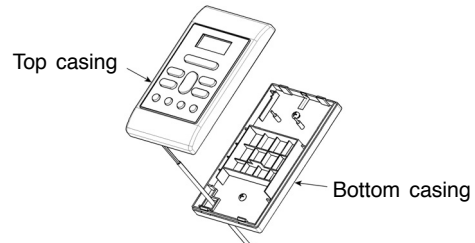
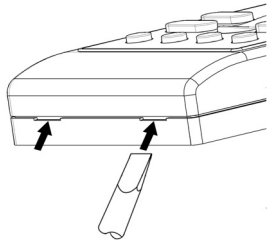

- Decide the fixing location of remote controller so that the length of wire shall be within 15 meters.



- Do not cut the provided wire. Excess wire should be properly wound and fitted at safe place.
- Do not join the wire with additional wire.

Wiring installation illustrations

Wall recessed wiring installation (Supplied)

1. When connecting the wires via the wall's recessed slot;
 - Fix the bottom casing to the wall by provided screw.
 - Assemble the top casing to the fixed bottom casing. (Refer to the illustration below for detail installation)

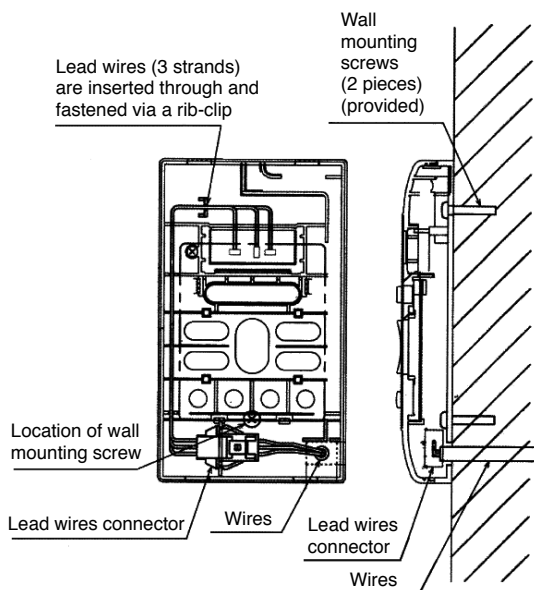

Inside top wiring installation (Alternative)

2. When the wires to be connected from the inside top portion of top casing;
 - Break off a perforated aperture located at the top portion of the bottom casing by nipper. Smoothen the aperture by cutter.
 - Fix the bottom casing to the wall by provided screw.
 - Connect the wires to the lead wires connector.
 - Mount the wires through the provided slot on top casing.
 - Assemble the top casing to the fixed bottom casing (Refer to the illustration below for detail installation)

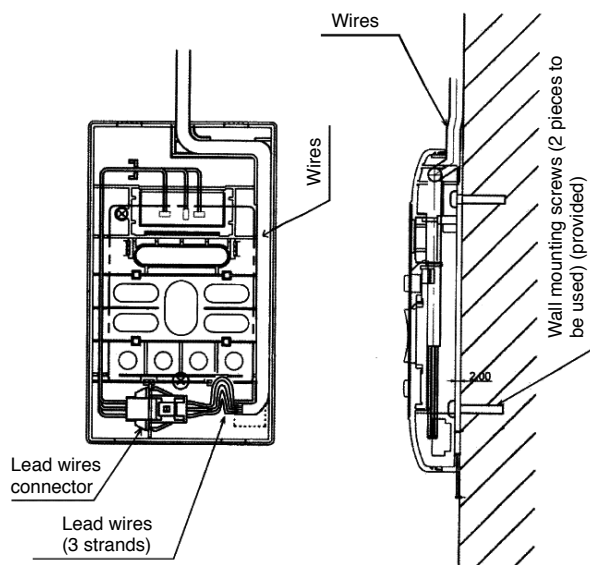

PREPARATION BEFORE OPERATION

■ To install the batteries

1. Slide the cover to take it off.
2. Install two dry batteries AAA.LR03 (alkaline).
The direction of the batteries should match the marks in the case.
3. Replace the cover at its original position.

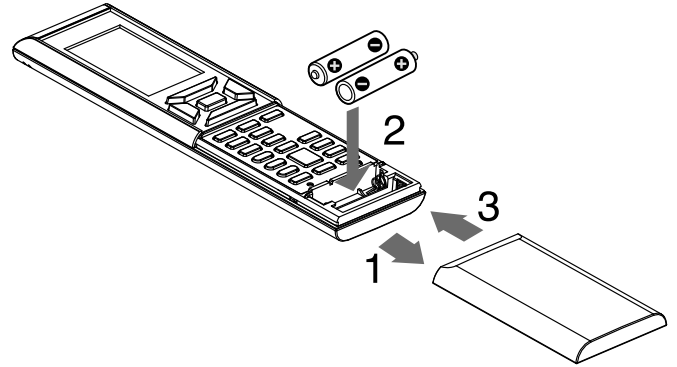

■ To fix the remote controller holder to the wall

1. Choose a place from where the signals can reach the unit.
2. Fix the remote controller holder to a wall, a pillar or similar location with the provided screws.
3. Place the remote controller in the remote controller holder.

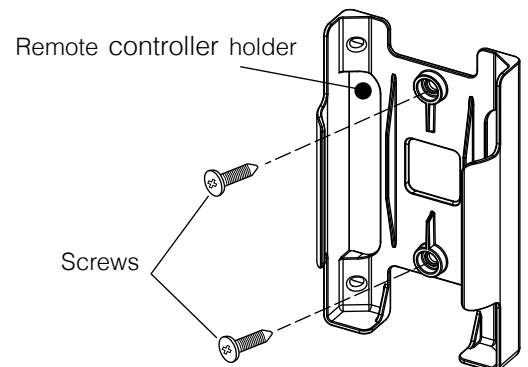
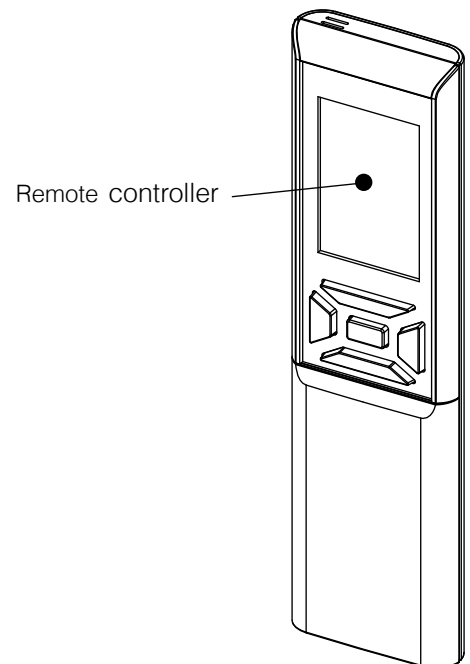

NOTE

Notes on batteries

- When replacing the batteries, use batteries of the same type, and replace both old batteries together.
- When the system is not used for a long time, take the batteries out.
- The batteries will last for approximately 1 year. However, if the remote controller display begins to fade and degradation of reception performance occurs within a year, replace both batteries with new size AAA.LR03 (alkaline).
- The attached batteries are provided for the initial use of the system.
The usable period of the batteries may be short depending on the manufactured date of the air conditioner.

Notes on the remote controller

- Never expose the remote controller to direct sunlight.
- Dust on the signal transmitter or receiver will reduce the sensitivity. Wipe off dust with soft cloth.
- Signal communication may be disabled if an electronic-starter-type fluorescent lamp (such as inverter-type lamps) is in the room. Consult the shop if that is the case.
- If the remote controller signals happen to operate another appliance, move that appliance to somewhere else, or consult the service shop.
- When the remote controller is not in use, please close the slide cover to prevent failure.

PREPARATION BEFORE OPERATION

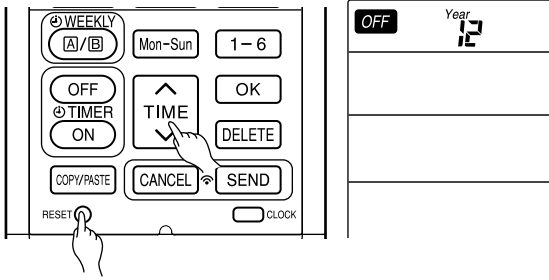

To set calendar and clock

1. Press **RESET** (RESET) button when first time setting. "Year" blinks.
 2. Press **TIME** (TIME) button to set the current year.
 3. Press **CLOCK** (CLOCK) button. "Day" and "Month" blink.
 4. Press **TIME** (TIME) button to set the current day and month.
 5. Press **CLOCK** (CLOCK) button. "CLOCK" blinks.
 6. Press **TIME** (TIME) button to set the clock to the current time.
 7. Press **CLOCK** (CLOCK) button.
- Calendar and clock are set.

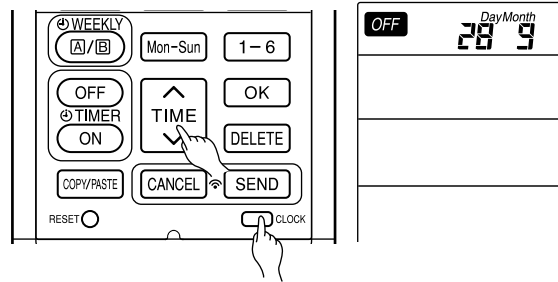

To modify the calendar and clock, press **CLOCK** (CLOCK) button.
Then follow steps 1 to 7.

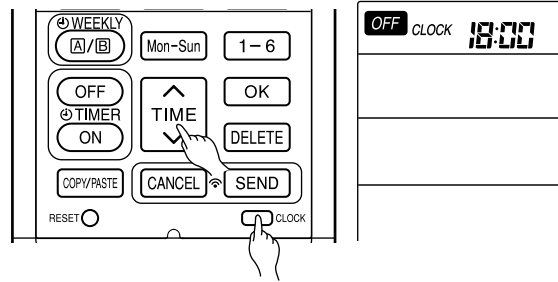

Calendar and clock need to be set again after changing batteries.

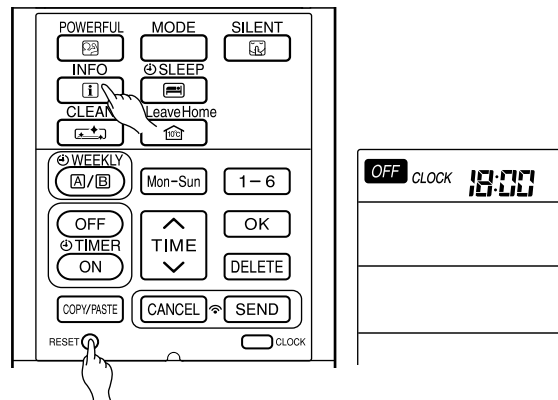

- After changing the batteries,
1. Press **RESET** (RESET) button.
 2. Direct remote controller towards indoor unit and press **INFO** (INFO) button.
 3. The calendar and clock from indoor unit will be transmitted.

- Calendar and clock will not be transmitted from indoor unit when the following occurs:
 - When there is a power failure.
 - When breaker is OFF by user (unit is not in STANDBY MODE).

NOTE

Note on setting the calendar and clock.

- If the calendar and clock are not set, the ON-timer, OFF-timer and Weekly Timer cannot be set.
- If the calendar and clock are not set correctly, the ON-timer, OFF-timer and Weekly Timer will not operate correctly.
- When the ON-timer, OFF-timer and Weekly Timer are set, the calendar and clock cannot be changed. If there is a need to change the calendar and clock, ON-timer, OFF-timer and Weekly Timer need to be cancelled.

NAMES AND FUNCTIONS OF REMOTE CONTROLLER

REMOTE CONTROLLER

- This controls the operation of the indoor unit. The range of control is about 7 meters. If indoor lighting is controlled electronically, the range of control may be shorter.
This unit can be fixed on a wall using the fixture provided. Before fixing it, make sure the indoor unit can be controlled from the remote controller.
- Handle the remote controller with care. Dropping it or getting it wet may compromise its signal transmission capability.
- After new batteries are inserted into the remote controller, the unit will initially require approximately 10 seconds to respond to commands and operate.
- When remote controller is not in use for about 3 minutes during OFF condition, indicated by **OFF** on the display, the LCD will turn off.
- During clock setting, the LCD will turn off about 10 minutes later if the remote controller is not in use.
- When pressing any button, the LCD will turn on.
- The LCD will not turn off during TIMER setting.

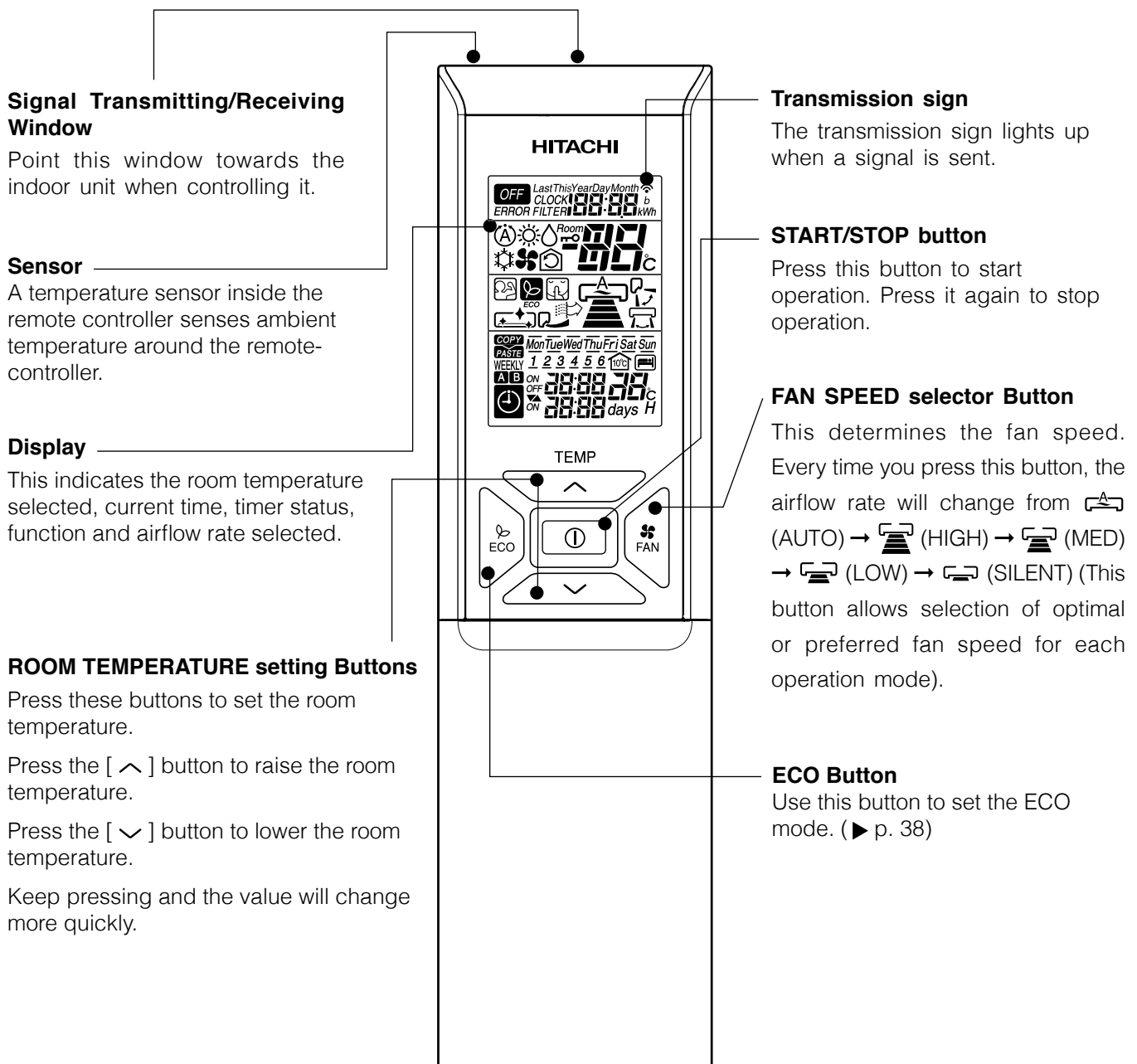

NAMES AND FUNCTIONS OF REMOTE CONTROLLER

POWERFUL Button

Use this button to set the POWERFUL mode. (▶ p. 36)

INFORMATION Button

(▶ p. 50)

ONE TOUCH CLEAN Button

(▶ p. 40)

LEAVE HOME Button

(▶ p. 39)

ECO SLEEP TIMER Button

Use this button to set the ECO sleep timer. (▶ p. 42)

ON / OFF TIMER setting Buttons

(▶ p. 41)

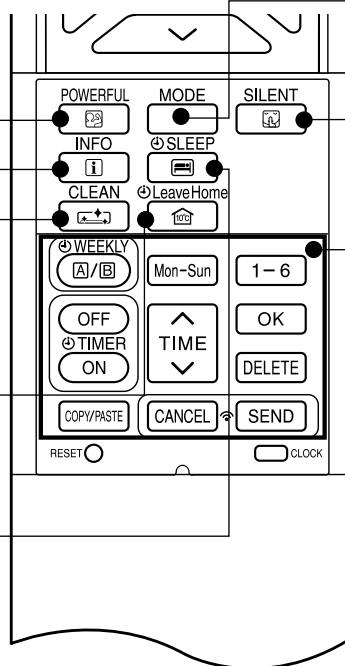

MODE selector Button

Use this button to select the operating mode. Every time you press this button, the mode will change from (AUTO) → (HEAT) → (DEHUMIDIFY) → (COOL) and → (FAN) cyclically.

SILENT Button

Use this button to set the SILENT mode. (▶ p. 37)

WEEKLY TIMER setting Buttons

(▶ p. 44)

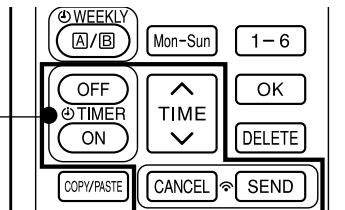

	MODE SELECTOR
	AUTO
	HEAT
	DEHUMIDIFY
	COOL
	FAN
	FAN SPEED
	AUTO
	SILENT
	LOW
	MED
	HIGH
	START / STOP

	ECO
	FAN
	POWERFUL
	SILENT
	INFO
	SLEEP TIMER
	LEAVE HOME
	CLEAN
Mon-Sun	DAY
1-6	PROGRAM NO.

	ON / OFF TIMER
	TIME
	OK
	DELETE
	COPY / PASTE
	CANCEL
	SEND
	CLOCK

Precautions for Use

- Do not put the remote controller in the following places.
 - Under direct sunlight.
 - In the vicinity of a heater.
- Handle the remote controller carefully. Do not drop it on the floor, and protect it from water.
- Once the outdoor unit stops, it will not restart for about 3 minutes (unless you turn the power switch off and on or unplug the power cord and plug it in again). This is to protect the device and does not indicate a failure.
- If you press the MODE selector button during operation, the device may stop for about 3 minutes for protection.

VARIOUS FUNCTIONS

Auto Restart Control

- If there is a power failure, operation will be automatically restarted when the power is resumed with previous operation mode and airflow direction.
(As the operation is not stopped by remote controller.)
- If you intend not to continue the operation when the power is resumed, switch off the power supply.
When you switch on the circuit breaker, the operation will be automatically restarted with previous operation mode and airflow direction.

Note: 1. If you do not require Auto Restart Control, please consult your sales agent.
2. Auto Restart Control is not available when Timer or Sleep Timer mode is set.

AUTOMATIC OPERATION

The device will automatically determine the mode of operation, HEAT or COOL depending on the current room temperature. The selected mode of operation will change when the room temperature varies. However, the mode of operation will not change when indoor unit is connected to multi type outdoor unit.

1 Press the MODE selector button so that the display indicates the **A** (AUTO) mode of operation.

- When AUTO has been selected, the device will automatically determine the mode of operation, HEAT or COOL depending on the current room temperature. However the mode of operation will not change when indoor unit is connected to multi type outdoor unit.
- If the mode automatically selected by the unit is not satisfactory, manually change the mode setting (HEAT, DEHUMIDIFY, COOL or FAN).

2 Set the desired FAN SPEED with the **FAN** (FAN SPEED) button (the display indicates the setting).

→ **(AUTO)** → **(HIGH)** → **(MED)** → **(LOW)** → **(SILENT)** →

3 Set the desired room temperature with the TEMPERATURE buttons (the display indicates the setting).
The temperature setting and the actual room temperature may vary depending on conditions.

START STOP Press the **(START/STOP)** button.
Operation starts with a beep.
Press the button again to stop operation.

- As the settings are stored in the memory of the remote controller, you only have to press the **(START/STOP)** button next time.

Press the **FAN** (FAN SPEED) button to select AUTO, HIGH, MED, LOW or SILENT.

HEATING OPERATION

- Use the device for heating when the outdoor temperature is under 21°C. When it is too warm (over 21°C), the heating function may not work in order to protect the device.
- In order to maintain reliability of the device, please use this device when outdoor temperature is above -15°C.

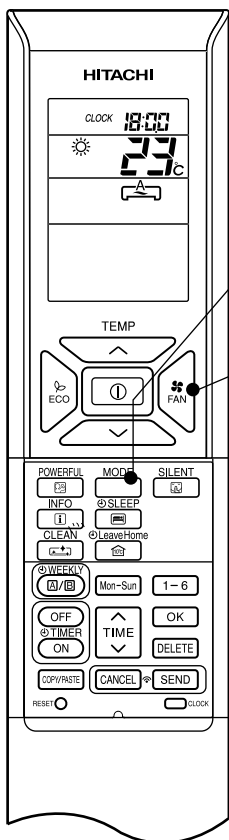

1

Press the MODE selector button so that the display indicates (HEAT).

2

Set the desired FAN SPEED with the (FAN SPEED) button (the display indicates the setting).

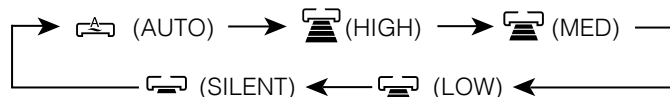

3

Set the desired room temperature with the TEMPERATURE buttons (the display indicates the setting).

The temperature setting and the actual room temperature may vary depending on conditions.

START STOP

Press the (START/STOP) button. Heating operation starts with a beep. Press the button again to stop operation.

- As the settings are stored in the memory of the remote controller, you only have to press the (START/STOP) button next time.
- During AUTO fan, the fan speed automatically changes as below:
 - When the difference between room temperature and setting temperature is large, fan starts to run at HI speed.
 - After room temperature reaches the preset temperature, fan speed will be changed to lower speed to obtain optimum room temperature condition for natural healthy heating.

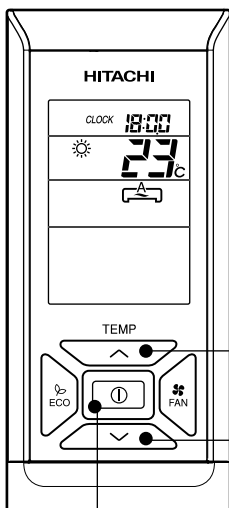

Defrosting



Defrosting will be performed about once an hour when frost forms on the heat exchange of the outdoor unit, for 5~10 minutes each time. During defrosting operation, the operation lamp blinks in a cycle of 3 seconds on and 0.5 second off. The maximum time for defrosting is 20 minutes. However, if the indoor unit is connected to multi type outdoor unit, the maximum time for defrosting is 15 minutes. (If the piping length used is longer than usual, frost is likely to form.)

DEHUMIDIFYING OPERATION

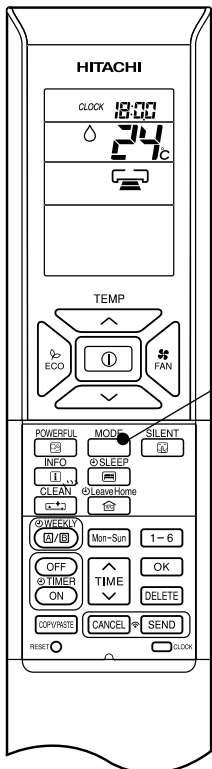
Use the device for dehumidifying when the room temperature is over 16°C.
When it is under 15°C, the dehumidifying function will not work.



1

Press the MODE selector button so that the display indicates  (DEHUMIDIFY).
The fan speed is set at LOW.
Press  (FAN SPEED) button to select SILENT or LOW fan speed.

2

Set the desired room temperature with the ROOM TEMPERATURE setting buttons (the display indicates the setting).

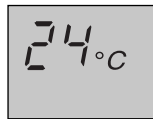

The range of 20-26°C is recommended as the room temperature for dehumidifying.

**START
STOP**

Press the  (START/STOP) button. Dehumidifying operation starts with a beep. Press the button again to stop operation.

- As the settings are stored in the memory of the remote controller, you only have to press the  (START/STOP) button next time.

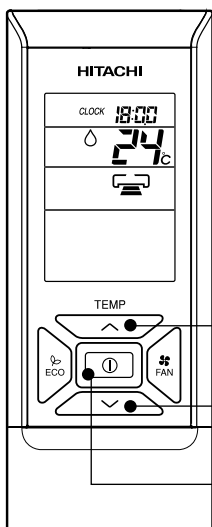



■ Dehumidifying Function

- When the room temperature is higher than the temperature setting: The device will dehumidify the room, reducing the room temperature to the preset level.
When the room temperature is lower than the temperature setting: Dehumidifying will be performed at the temperature setting slightly lower than the current room temperature, regardless of the temperature setting.
- The preset room temperature may not be reached depending on the number of people present in the room or other room conditions.

COOLING OPERATION

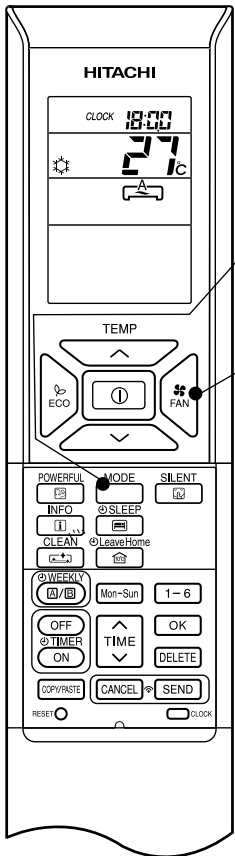
Use the device for cooling when the outdoor temperature is -10~ 43°C.
 If indoors humidity is very high (80%), some dew may form on the air outlet grille of the indoor unit.



1 Press the MODE selector button so that the display indicates  (COOL).

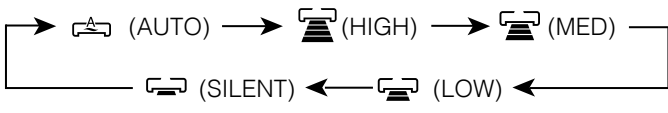

2 Set the desired FAN SPEED with the  (FAN SPEED) button (the display indicates the setting).





3 Set the desired room temperature with the TEMPERATURE buttons (the display indicates the setting).

The temperature setting and the actual room temperature may vary depending on conditions.

START STOP

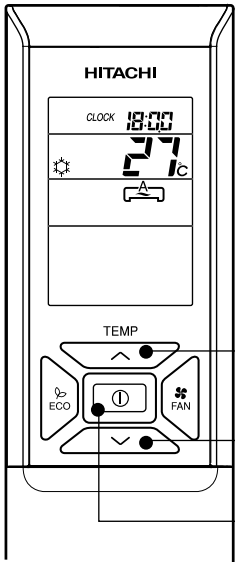
Press the  (START/STOP) button. Cooling operation starts with a beep. Press the button again to stop operation. The cooling function does not start if the temperature setting is higher than the current room temperature (even though the  (OPERATION) lamp lights). The cooling function will start as soon as user set the temperature below the current room temperature.



- As the settings are stored in the memory of the remote controller, you only have to press the  (START/STOP) button next time.
- During AUTO fan, the fan speed automatically changes as below:
 - When the difference between room temperature and setting temperature is large, fan starts to run at HI speed.
 - After room temperature reaches the preset temperature, fan speed will be changed to lower speed to obtain optimum room temperature condition for natural healthy cooling.

FAN OPERATION

User can use the device simply as an air circulator.

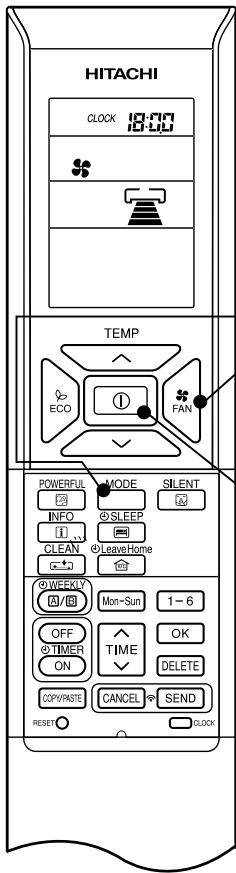

1

Press the MODE selector so that the display indicates  (FAN).

2

Set the desired FAN SPEED with the  (FAN SPEED) button (the display indicates the setting).

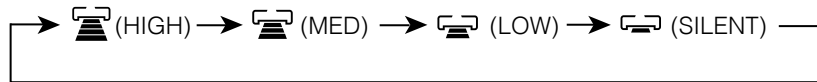

**START
STOP**

Press the  (START/STOP) button. Fan operation starts with a beep. Press the button again to stop operation.



POWERFUL OPERATION

- By pressing  (POWERFUL) button during AUTO, HEATING, DEHUMIDIFYING, COOLING or FAN operation, the air conditioner performs at the maximum power.
- During POWERFUL operation, cooler or warmer air will be blown out from indoor unit for COOLING or HEATING operation respectively.

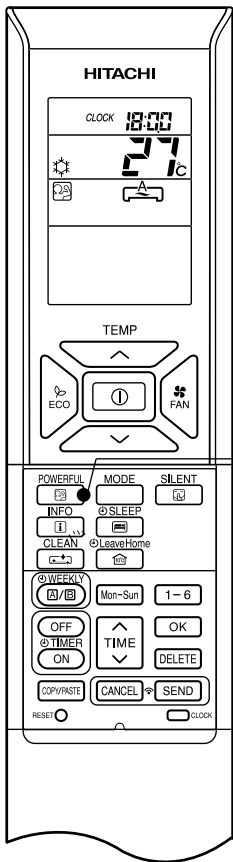



■ To start POWERFUL operation

- Press  (POWERFUL) button during operation.

“” is displayed on the LCD.

POWERFUL operation ends in 20 minutes. Then the system automatically operates with the previous settings used before POWERFUL operation.

■ To cancel POWERFUL operation

- Press the  (START/STOP) button. Or
- Press  (POWERFUL) button again.

POWERFUL operation stops.

“” disappears from the LCD.

NOTE



- When SLEEP mode, ECO mode, SILENT mode or LEAVE HOME mode is selected, POWERFUL operation is cancelled.
- During POWERFUL operation, capacity of the air conditioner will not increase
 - if the air conditioner is already running at maximum capacity.
 - just before defrost operation (when the air conditioner is running in HEATING operation).
- After auto restart, POWERFUL operation is cancelled and previous operation shall start.
- For multi model connections, POWERFUL operation may not function depending on operation conditions.

SILENT OPERATION

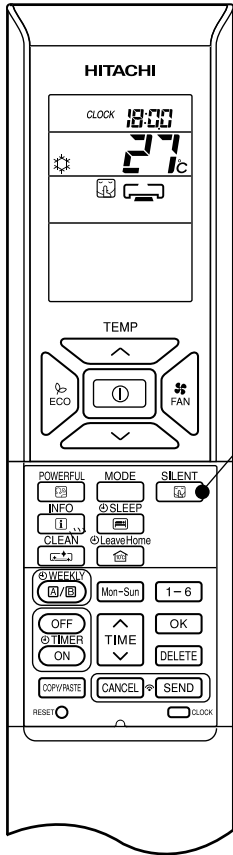



- By pressing  (SILENT) button during AUTO, HEATING, DEHUMIDIFYING, COOLING or FAN operation, the fan speed will change to ultra slow.





■ To start SILENT operation

- Press  (SILENT) button during operation.
 - "" is displayed on the LCD. Fan speed will be ultra slow.

■ To cancel SILENT operation

- Press  (START/STOP) button. Or
 - Press  (SILENT) button again or  (FAN SPEED) button.
- Fan speed will return to previous fan speed before SILENT operation starts.
- SILENT operation stops.
- "" disappears from the LCD.

NOTE

- When POWERFUL operation is selected, SILENT operation is cancelled. Fan speed will return to previous fan speed before SILENT operation.
- After auto restart, SILENT operation is cancelled. Fan speed will return to previous fan speed before SILENT operation.
- During any operation with fan speed  (SILENT), if press  (SILENT) button, fan speed will not change.



ECO OPERATION

ECO operation is an energy saving function by changing set temperature automatically and by limiting the maximum power consumption value.

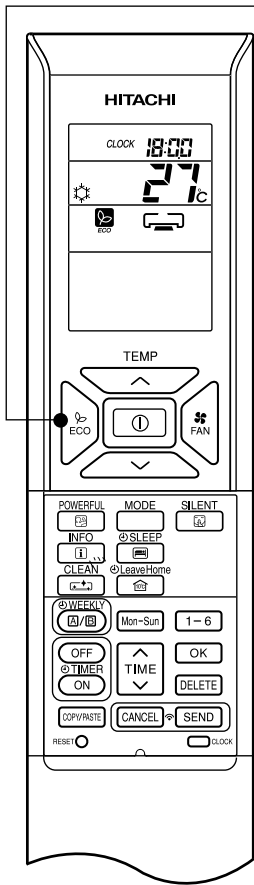

1

- By pressing the  (ECO) button during AUTO, HEATING, DEHUMIDIFYING or COOLING operation, the air conditioner performs the "ECO" operation.



■ To start ECO operation

- Press  (ECO) button during operation.

“” is displayed on the LCD.

Energy saving operation will start by changing the set temperature higher or lower automatically and reducing operation power consumption. This function may vary based on the connected outdoor unit.

■ To cancel ECO operation

- Press  (START/STOP) button. Or
- Press  (ECO) button again.

“” disappears from the LCD.

NOTE

- ECO function will not be effective when power consumption is low.
- By pressing (POWERFUL) button, ECO operation is cancelled.
- After auto restart, ECO operation is cancelled and previous operation mode shall start.
- For multi model connections, energy saving operation shall start only by changing set temperature higher or lower automatically. However, effectiveness of ECO depends on operation conditions.

10°C LEAVE HOME(LH) OPERATION

Prevent the room temperature from falling too much by setting temperature 10°C automatically when no one is at home.
This operation is able to operate by "Continuous operation" or "Day timer operation". Please use "Day timer operation" to set the number of days up to 99 days.

Continuous operation

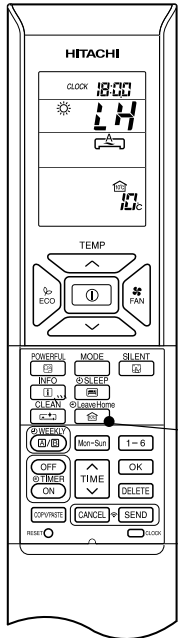

Day timer operation

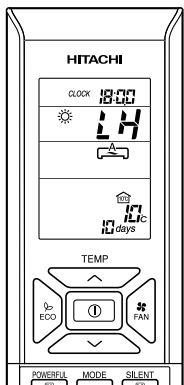

To start LEAVE HOME operation

Option 1. Continuous operation.

- Press (LEAVE HOME) button during stop or operation.
Room temperature is set at 10°C and heating operation starts.
“☀”, “LH”, “”, “” is displayed on the LCD.

Option 2. Day timer operation.

- Press (LEAVE HOME) button during stop or operation.
Room temperature is set at 10°C and heating operation starts.
“☀”, “LH”, “”, “” is displayed on the LCD.

- Set number of operation days (1 to 99 days), if needed.

Press (TIME) button to select number of days.

Number of days blink.

- * Press “ (UP)” to set number of days from 1 day, 2 days, 3 days 98 days, 99 days, 1 day and so on.
- * Press “ (DOWN)” to set number of days from 99 days, 98 days, 97 days 3 days, 2 days, 1 day, 99 days and so on.
- * Number of day is counted when clock indicates 0:00.

- Press (SEND) button to confirm number of operation days. Display for number of operation days will stop blinking.
- Press (CANCEL) button to reset number of operation days or to have continuous operation.

To cancel LEAVE HOME operation

- Press (START/STOP) button. Or
- Press (LEAVE HOME) button again.
Return to previous operation mode. Or
- Change to other operation mode by pressing (MODE) button.

NOTE

- After reaching the set number of operation days for Leave Home or by pressing the (Leave Home) button again, the unit will operate in previous mode.
- During Leave Home operation, fan speed and horizontal air deflector position cannot be changed.
- By pressing (Leave Home) button, implementation of Weekly Timer or Once Timer is cancelled.
- In case of power supply shut down, after autorestart, all setting for number of days operation will be reset and unit shall be in continuous operation.
- For multi connections, when each room is running in different operation modes such as FAN only, COOLING, DEHUMIDIFYING or AUTO mode, Leave Home operation cannot operate even though it is possible to set Leave Home operation.
In order to start Leave Home operation, all rooms must stop its operation. Then, press (LEAVE HOME) button to operate Leave Home operation.
- For multi connections, when all rooms are running HEATING operation, it is possible to operate Leave Home operation by pressing the (LEAVE HOME) button.
- For multi connections, if two or more rooms are set to operate Leave Home operation, the capability to reach the set temperature at 10°C may not possible. In addition, this also depends on outdoor temperature.
- POWERFUL, SILENT and ECO operations are not applicable during Leave Home operation.



CLEAN (ONE TOUCH CLEAN) OPERATION

Drying indoor heat exchanger after cooling operation to prevent mildew.

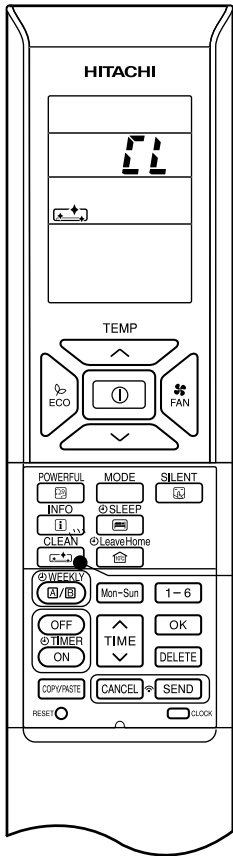



■ To start CLEAN operation

- Press  (CLEAN) button when unit is OFF.
Total time taken for One Touch Clean operation is 60 minutes.
During this operation, HEATING or FAN operation shall operate.

During one touch clean, operation lamp is blinking.

“”, “” is displayed on the LCD.

■ To cancel CLEAN operation

- Press  (START/STOP) button. Or
- Press  (CLEAN) button again.

NOTE

- When CLEAN operation finish, unit will switch OFF automatically.
- If Weekly Timer or Once Timer is set, there is a need to cancel those timer before operating CLEAN function.
- For multi connections, when pressing  (CLEAN) button, operation is limited to FAN operation.
- For multi connections, when one room operates CLEAN operation first, other rooms can operate COOLING, DEHUMIDIFYING or FAN operation. However, when other rooms need to operate HEATING operation, air conditioner will be in STANDBY mode. After CLEAN operation finish, HEATING operation will start.



ONCE TIMER (ON/OFF TIMER) OPERATION

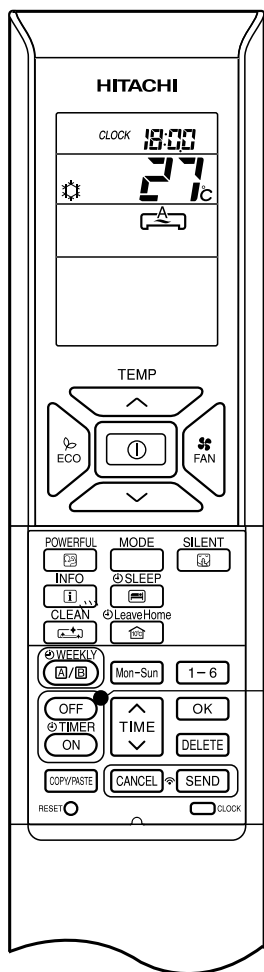

OFF TIMER

The device can be set to turn off at a preset time.

1. Press (OFF-TIMER) button. and **0:00** blink on the display.
2. Set the "turn-off time" with (TIME) button.
3. After setting, direct the remote controller towards the indoor and press (SEND) button.
 and "set time" lights up instead of blinking.

A beep sound emitted from indoor unit and the (TIMER) lamp on the indoor unit lights up.

ON TIMER

The device will turn on at a designated time.

1. Press (ON-TIMER) button. and **0:00** blink on the display.
2. Set the "turn-on time" with (TIME) button.
3. After setting, direct the remote controller towards the indoor and press (SEND) button.
 and "set time" light up instead of blinking.

A beep sound emitted from indoor unit and the (TIMER) lamp on the indoor unit lights up.

ON/OFF TIMER

- The device will turn on (off) and off (on) at the designated time.
- The switching occurs first at the preset time that comes earlier.
- The arrow mark appears on the display to indicate the sequence of switching operations.

1. Press (OFF-TIMER) button so that and **0:00** blink on the display.
2. Set the "turn-off" time with (TIME) button. After setting, direct the remote controller towards the indoor and press (SEND) button.
3. Press (ON-TIMER) button so that and set "turn-off" time light up. The and **0:00** blink.
4. Set the "turn-on" time with (TIME) button.
5. After setting, direct the remote controller towards the indoor and press (SEND) button.
 and set "turn-on" time light up instead of blinking.

A beep sound emitted from indoor unit and the (TIMER) lamp on the indoor unit lights up.

- The timer may be used in three ways: OFF-timer, ON-timer and ON/OFF (OFF/ON)-timer. Set the current time first because it serves as a reference.

■ To cancel Reservation

- Point the signal window of the remote controller towards the indoor unit and press (CANCEL) button.
 and "ON or OFF set time" goes out with a beep and the (TIMER) lamp on the indoor unit turns off.

NOTE

- User can set only one of the OFF-timer, ON-timer or ON/OFF-timer.
- If WEEKLY TIMER already set, by setting the ONCE TIMER, ONCE TIMER operation is prioritized. When ONCE TIMER operation is complete, WEEKLY TIMER operation will be activated.



ECO SLEEP TIMER OPERATION

The timer can be set up to a duration of 7 hours.

By pressing (SLEEP) button during AUTO, HEATING, DEHUMIDIFYING, COOLING or FAN operation, the unit shifts the room temperature and reduces the fan speed. It results in energy saving.

Set the current time first before operating the ECO SLEEP TIMER operation.

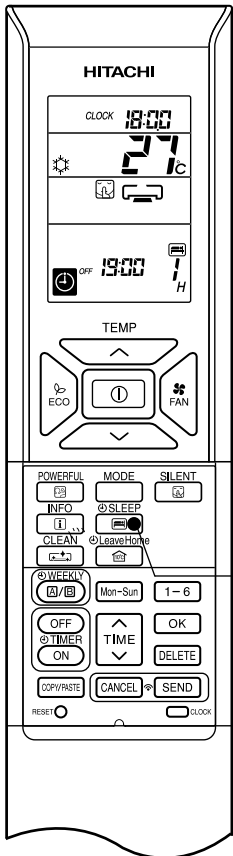

To start ECO SLEEP TIMER operation

Press (SLEEP) button during operation.

- “”, “”, “”, “OFF”, off time, “” and number of hour are displayed on the remote controller display.
- During ECO SLEEP TIMER operation, fan speed will be ultra slow.
- A beep sound emitted from indoor unit and the (TIMER) lamp on the indoor unit lights up.

Pressing (SLEEP) button repeatedly, the number of hours will change as below:

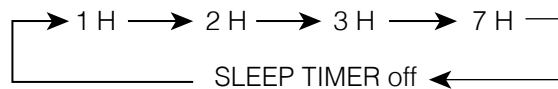

- During ECO SLEEP TIMER operation, air conditioner will continue to operate for the designated number of hours and then turn off.
- When the ECO SLEEP TIMER has been set, the display on the remote controller indicates the turn off time.



Example: If ECO SLEEP TIMER is set for 1 hour at 18:00, the switch off time will be at 19:00.

To cancel ECO SLEEP TIMER operation

Press (START/STOP) button.

- Room air conditioner will switch off.

Press (SLEEP) button again until “”, “”, “”, off time, “” and number of hour disappear from the remote controller display.

Press (CANCEL) button.

- A beep sound emitted from indoor unit and the (TIMER) lamp on the indoor unit turns off.
- SLEEP TIMER operation is cancelled.



ECO SLEEP TIMER OPERATION

To set ECO SLEEP TIMER and ON TIMER

The air conditioner will be turned off by ECO SLEEP TIMER and turned on by ON TIMER.

1. Set the ON TIMER.
2. Press (SLEEP) button and set ECO SLEEP TIMER.



Example:
In this case, air conditioner will turn off in 2 hours (at 1:38) and it will be turned on at 6:00 the next morning.

To cancel ECO SLEEP TIMER and ON TIMER operation

Direct the remote controller towards the indoor unit and press (CANCEL) button.

- “”, “”, “”, “OFF”, off time, “”, number of hour, “ON” and ON TIMER set time disappear from the remote controller display.
- A beep sound emitted from indoor unit and the (TIMER) lamp on the indoor unit turns off.
- ECO SLEEP TIMER and ON TIMER reservations are cancelled.

30 minutes after setting ECO SLEEP TIMER, outdoor fan speed will be reduced to lower the noise level and to have comfort operation.

1 hour after setting ECO SLEEP TIMER, set temperature will be slightly shifted. Amount of temperature shifted depends on type of air conditioner.

These automatic operation changes contribute to energy saving without losing comfort.

The level of energy consumption depends on outside temperature, room temperature, set temperature or air conditioner type.

Cooling operation [diagram representation for illustrative purpose only]

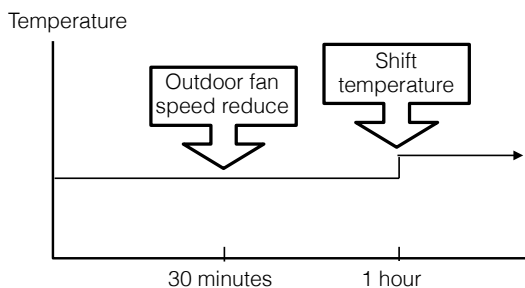

Heating operation [diagram representation for illustrative purpose only]

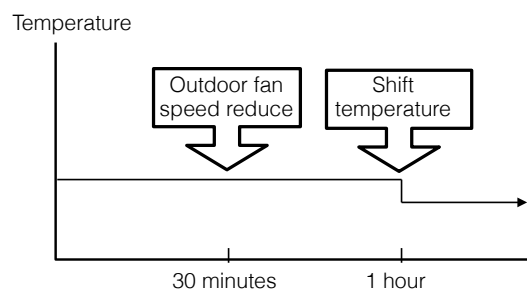

NOTE

- If ECO SLEEP TIMER is set when OFF TIMER or ON/OFF TIMER has been set earlier, the ECO SLEEP TIMER becomes effective instead of the OFF TIMER or ON/OFF TIMER.



WEEKLY TIMER OPERATION

- It is possible to select Mode A or Mode B. For each mode, up to 6 programs can be set per day. In total, a maximum of 42 programs can be set for a week for each mode.
- If calendar and clock are not set, the reservation setting for WEEKLY TIMER cannot be set.
- If calendar and clock are not set correctly, WEEKLY TIMER will not operate correctly.
- Reservation for calendar and clock shall be set first before operating WEEKLY TIMER.

Step 1: Set the reservation schedule to the remote controller. Send the registered reservation to indoor unit and then operate.

Step 2: Select Mode A or Mode B and activate or deactivate WEEKLY TIMER .

Step 3: Copy and cancel the reservation schedule.

Step 1 : Set reservation schedule to the remote controller. Send the registered reservation to indoor unit and then operate.

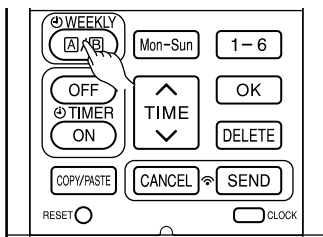

1

How to set a WEEKLY TIMER.

1. Select Mode A or Mode B

Press (WEEKLY) button. WEEKLY lights up. **A** and blink on the display. (Mode A is selected).

Press (WEEKLY) button again, **B** and blink on the display. (Mode B is selected).

- If no reservation has been made, ON/OFF, --:-- , appear.
- If reservation has been made, ON/OFF, --:-- , will not appear.

2

2. Set a program

Press (WEEKLY) button for about 3 seconds. The selection mode can be changed.

, day: Mon, program no. : 1, ON/OFF, setting time and setting temperature blink on the display.

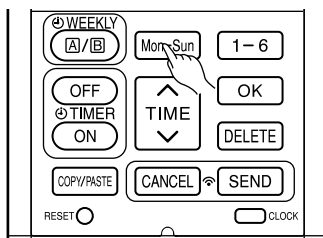

3

3. Select the desired day of the week

Press (DAY) button.

The day changes from Mon → Tue → Wed → Thu → Fri → Sat → Sun → Mon, Tue, Wed, Thu, Fri, Sat, Sun [Full days] → Mon, Tue, Wed, Thu, Fri [weekday] → Sat, Sun [weekend] → Mon → Tue

Select [Full days] for daily reservation.

Select [weekday] for Monday to Friday reservation.

Select [weekend] for Saturday and Sunday reservation.

- After reservation has been set, it is easy to check and edit at the same time.

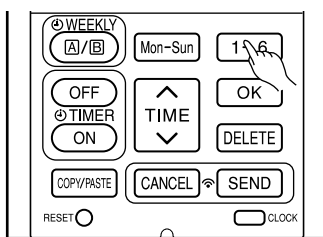

4

4. Press button to select a program number.

The number changes from 1 → 2 → 3 → 4 → 5 → 6 → 1 → 2

- If program number has been set, follow above in order to make changes.



WEEKLY TIMER OPERATION

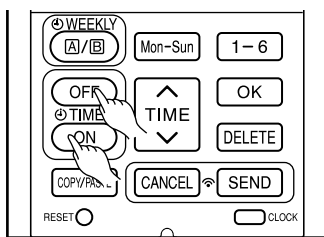

5

5. Press (ON-OFF TIMER) button to select ON TIMER or OFF TIMER reservation.

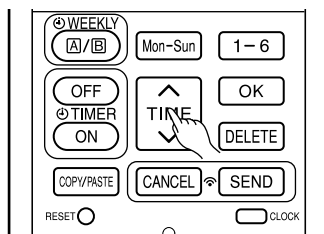

6

6. Press (TIME) button to set time reservation.

7. Press (TEMP \wedge or \vee) button to set temperature reservation.

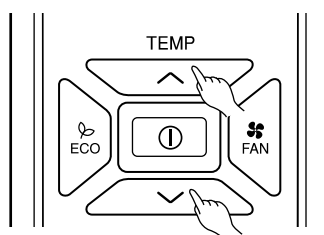

7

8. Press (OK) button. The reservations are set. Day, program number, ON reservation, setting temperature will light up. will be continuously blinks. If reservation is not complete, settings will not be stored in memory.

To continue with the reservation, press buttons. Follow step 3 to 8 for reservation.

9. After all the reservations have been set, press (SEND) button while directing the remote controller towards the indoor unit for about 3 seconds. Timer lamp on the indoor unit will blink rapidly.

After beep sound emitted from indoor unit, TIMER lamp will light up.

Please ensure that the TIMER lamp lights up.

This indicates that the reservation has been stored in the indoor unit and Timer function has been completed.

The reservation contents will appear on the remote controller display.

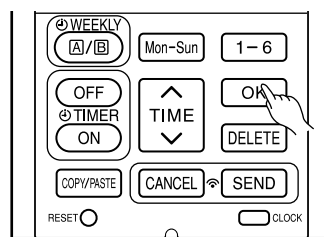

8

- If TIMER lamp on the indoor unit does not light up, press (SEND) button while directing the remote controller towards the indoor unit for about 3 seconds.

- **CAUTION !** Do not press (CANCEL) button during reservation setting because this will result in all reservation contents to be lost.

- The reservation contents will not stored in the indoor unit until (SEND) button has been pressed.

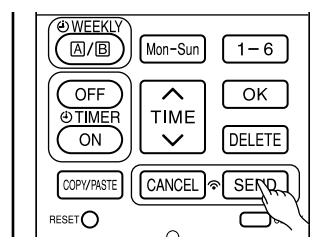

9

NOTE

- Up to 6 programs can be set per day. Setting ON TIMER or OFF TIMER for each program number can be at random. When pressing (SEND) button, the set ON TIMER or OFF TIMER for each program number will automatically arranged so that program number 1 shall have the earliest time and program number 6 shall have the latest time.

If the setting time is the same, Priority will be given to the latest reservation contents.

- **CAUTION !** If the remote controller is left idle and (SEND) button is not pressed within 3 minutes after reservations have been made , all current reservations will be lost.



WEEKLY TIMER OPERATION

Step 2: Select Mode A or Mode B and activate or deactivate WEEKLY TIMER.

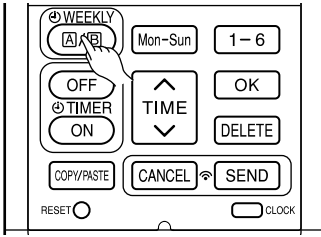

1

■ How to select Mode A or Mode B of WEEKLY TIMER setting.

1. Press (WEEKLY) button. **A** and blink on the display. (Normally Mode A will blink first).
2. Press (WEEKLY) button again. **B** and blink on the display.
3. Select Mode A or Mode B. Press (SEND) button while directing the remote controller towards the indoor unit for about 3 seconds. Timer lamp on the indoor unit will blink rapidly.

2

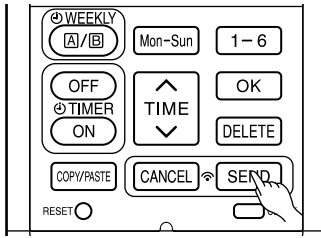

3

After beep sound emitted from indoor unit, TIMER lamp will light up.

Please ensure that the TIMER lamp lights up.

This indicates that Mode A or Mode B selection and active WEEKLY TIMER have been confirmed.

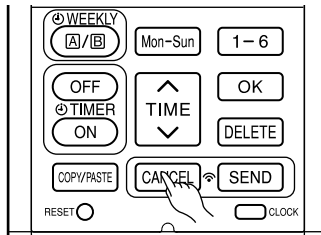

1

■ Setting non-active WEEKLY TIMER .

1. Direct the remote controller towards the indoor unit and press (CANCEL) button.
Beep sound will be emitted from indoor unit and TIMER lamp will be OFF. Reservation indication on remote display will also disappear. This indicates that non-active WEEKLY TIMER has been confirmed.
- To activate back the setting of WEEKLY TIMER , repeat the steps for "How to select Mode A or Mode B of WEEKLY TIMER setting".

NOTE

- When setting ONCE TIMER, operation of WEEKLY TIMER is interrupted. After ONCE TIMER operation is complete, WEEKLY TIMER operation will be activated.
- When ONCE TIMER is cancelled, operation of WEEKLY TIMER is also cancelled. Need to set WEEKLY TIMER operation for activation.
- After auto restart, WEEKLY TIMER operation is cancelled. Need to set WEEKLY TIMER operation for activation.

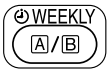

WEEKLY TIMER OPERATION

Step 3: Copy and cancel the reservation schedule.

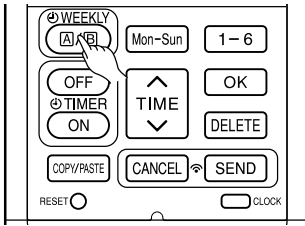

1

■ How to copy and paste.

Editing the reservation schedule is easy by copying data from one day to another day.

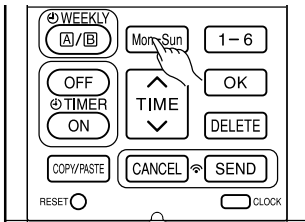

2

2. Press **WEEKLY (A/B)** (WEEKLY) button for about 3 seconds to start editing the reservation schedule.

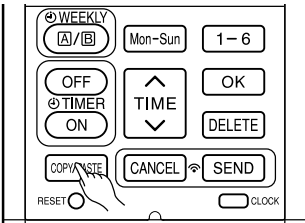

3

3. Press **Mon-Sun** (DAY) button to select a day of the week to copy.

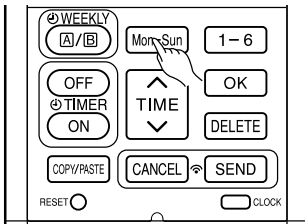

4

4. Press **COPY/PASTE** (COPY/PASTE) button. Then "PASTE" blinks on the display.
* Press **CANCEL** (CANCEL) button to cancel the COPY mode. Normal setting mode is activated.

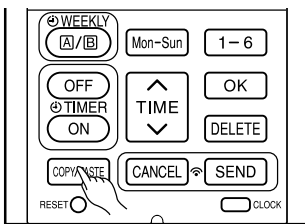

5

5. Press **Mon-Sun** (DAY) button to select a day of the week to paste.

6. Press **COPY/PASTE** (COPY/PASTE) button one more time to paste.  only blinks on the display.

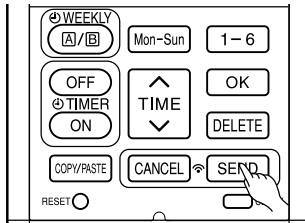

6

7. To continue copying to other days, press **Mon-Sun** or **1-6** or **TIME** or .

Then start from step 3.

8. After copy and paste completed, press **SEND** (SEND) button while directing the remote controller towards the indoor unit for about 3 seconds. Timer lamp on the indoor unit will blink rapidly. After beep sound emitted from indoor unit, TIMER lamp will light up.

8

Please ensure that the TIMER lamp lights up.

If TIMER lamp does not light up, Press **SEND** (SEND) button again.

● Reservation data will not change if **SEND** (SEND) button is not pressed.

NOTE

● If there is no reservation data, copying data from one day to another day cannot be done.

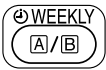

WEEKLY TIMER OPERATION

Step 3: Copy and cancel the reservation schedule.

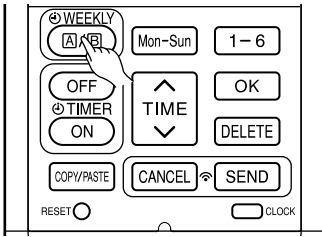

1

- How to delete WEEKLY TIMER data.

[Delete one program number reservation]

2

- Press (WEEKLY) button to select Mode A or Mode B.
- Press (WEEKLY) button for 3 seconds to start editing the reservation schedule.

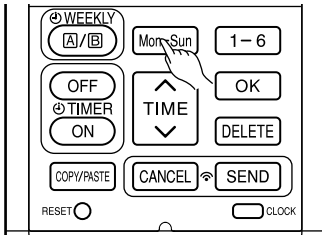

3

- Press (DAY) button to select a day of the week to edit.
- Press to select program number. Selected program number will blink.
- Press (DELETE) button. Reservation of selected program number is deleted.

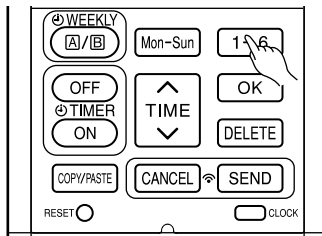

4

- After deleting, press (SEND) button while directing the remote controller towards the indoor unit for about 3 seconds. Timer lamp on the indoor unit will blink rapidly. After beep sound emitted from indoor unit, TIMER lamp will light up.

Please ensure that the TIMER lamp lights up.

- Reservation will not change if (SEND) button is not pressed.

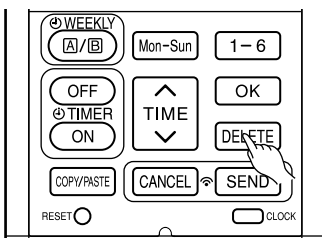

5

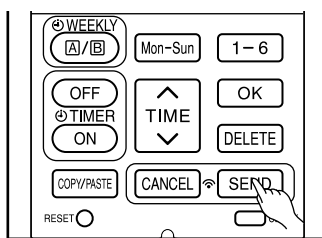

6



WEEKLY TIMER OPERATION

Step 3: Copy and cancel the reservation schedule.

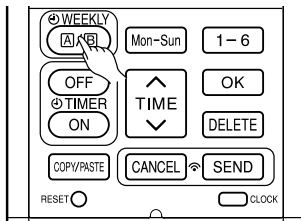

①

[Delete one day reservation]

1. Press (WEEKLY) button to select Mode A or Mode B.

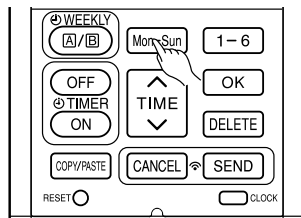

②

2. Press (WEEKLY) button for 3 seconds to start editing the reservation schedule.

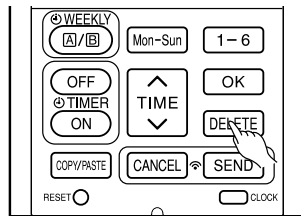

③

3. Press (DAY) button to select a day of the week to edit.

4. Press (DELETE) button for about 10 seconds. Reservations for all program numbers will be deleted.

- If press for a short time, reservation for one program number will be deleted.

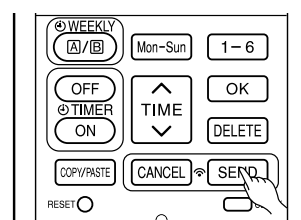

④

5. After deleting, press (SEND) button while directing the remote controller towards the indoor unit for about 3 seconds. Timer lamp on the indoor unit will blink rapidly.

After beep sound emitted from indoor unit, TIMER lamp will light up.

Please ensure that the TIMER lamp lights up.

- Reservation will not change if (SEND) button is not pressed.

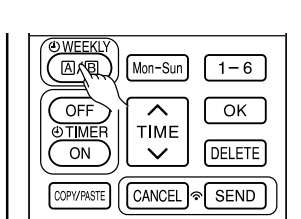

⑤

[Delete Mode A or Mode B]

1. Press (WEEKLY) button to select Mode A or Mode B.

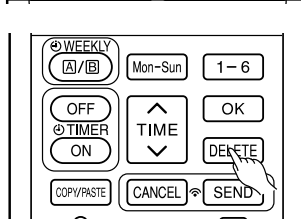

①



2. Direct the remote controller towards the indoor unit and press (DELETE) button for about 10 seconds while Mode A or Mode B display blinks.

After beep sound emitted from indoor unit, reservations for Mode A or Mode B will disappear.

②

NOTE

- If all reservations in the remote controller were deleted and pressed (SEND) button, no signal will be transmitted to indoor unit. TIMER lamp will remain off and no changes will be done to the reservations stored in the indoor unit.

- By pressing  (INFO) button, temperature around remote controller and monthly power consumption will be displayed on the remote controller.
- After changing the batteries, direct the remote controller towards the indoor unit and press  (INFO) button. Current calendar and clock will be transmitted from indoor unit.
- In order to receive information from indoor unit, the distance between remote controller and receiver of indoor units is within 2 meters.

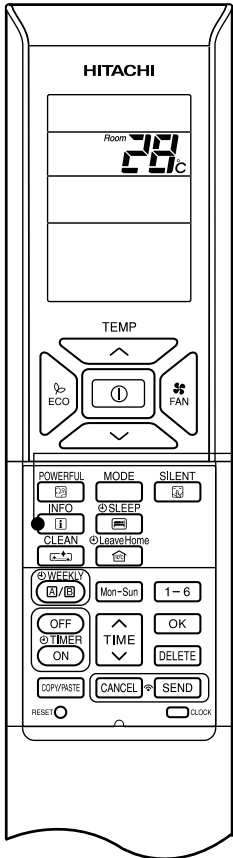

■ To check temperature around remote controller

1

Press  (INFO) button.

Temperature will be displayed for 10 seconds.

■ To check monthly power consumption

Direct the remote controller towards the receiver of indoor unit (within 2 meters in front of indoor unit) and press  (INFO) button. Wait for 2 seconds for signal transmission.

While temperature around remote controller is displayed, press  (INFO) button repeatedly. The display will show as below:

this month power consumption amount for heating → last month power consumption amount for heating → this month power consumption amount for cooling → last month power consumption amount for cooling → temperature around remote controller → this month power consumption amount for heating cyclically.

- If indication is not given, bring remote controller closer to the receiver of the indoor unit.
- Indicated value shall be regarded as a guide only.



■ Current calendar and clock can be retrieved from indoor unit

Direct the remote controller towards the receiver of indoor unit (within 2 meters in front of indoor unit) and press  (INFO) button. Wait for 2 seconds for signal transmission.

Once received the current calendar and clock, check whether they are correct or not by pressing  (CLOCK) button.

- If there is no power supply to indoor unit or calendar and clock have not been set, INFO function cannot be used for sending or receiving information.

NOTE

- In case failure occurs to the air conditioner, by pressing  (INFO) button, an error code will be displayed. Direct the remote controller towards the receiver of indoor unit (within 2 meters in front of indoor unit) and press  (INFO) button. Wait for 2 seconds for signal transmission. An error code will be displayed. Call service center and inform the error code.
- Information of "Monthly power consumption" are not available for model RAM-130NP6A.
- Info Function to check monthly power consumption. During installation, in case of power failure or breaker ON / OFF, ensure to set the clock and calendar for each indoor unit (unit in standby mode or auto restart), for single or multi connection, by pressing  (START / STOP) button. Failure to do the above, monthly power consumption amount will not be displayed on the remote controller.

OPERATION MODE LOCK

The remote controller can be set to fix the HEATING mode (including FAN), COOLING mode (including FAN) and DEHUMIDIFYING mode (including FAN) operations.

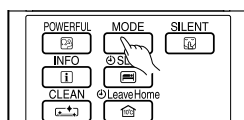
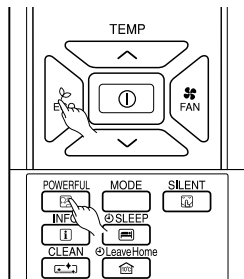

■ Method to lock HEATING mode (including FAN) operation.

Press (ECO) and (POWERFUL) buttons simultaneously for about 5 seconds when the remote controller is OFF.

“”, “” and “” will be displayed for about 10 seconds. Later, “” and “” will remain.

This indicates that HEATING mode operation is locked.

When pressing (MODE) button, “” or “” will be displayed.

■ Method to unlock HEATING mode (including FAN) operation.

Press (ECO) and (POWERFUL) buttons simultaneously for about 5 seconds when the remote controller is OFF.

All operation mode symbols will appear on the display for about 10 seconds. After that, operation mode symbol before cancellation will be displayed.

This indicates that HEATING mode operation is unlocked.

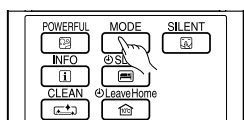
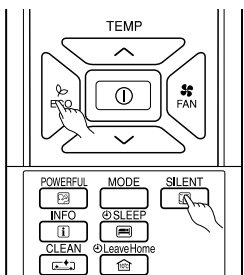

■ Method to lock COOLING and DEHUMIDIFYING modes (including FAN) operations.

Press (ECO) and (SILENT) buttons simultaneously for about 5 seconds when the remote controller is OFF.

“”, “”, “” and “” will be displayed for about 10 seconds. Later, “” and “” will remain.

This indicates that COOLING and DEHUMIDIFYING mode operation is locked.

When pressing (MODE) button, “”, “” or “” will be displayed.

■ Method to unlock COOLING and DEHUMIDIFYING modes (including FAN) operations.

Press (ECO) and (SILENT) buttons simultaneously for about 5 seconds when the remote controller is OFF.

All operation mode symbols will appear on the display for about 10 seconds. After that, operation mode symbol before cancellation will be displayed.

This indicates that COOLING and DEHUMIDIFYING modes operation is unlocked.

NOTE

- Operation Mode Lock function will not activate if TIMER reservations activate. TIMER reservations shall be deactivated first. Then, Operation Mode Lock function can be activated.
- HEATING, COOLING and DEHUMIDIFYING mode (including FAN) operations can be unlocked by pressing the (RESET) button. However, by pressing the (RESET) button, all the information stored in the remote controller will disappear. You may need to set the necessary information again.
- For multi connections, unit and mode which is set to lock HEATING and switched on first shall have higher priority. Other units which are chosen to operate at different modes shall be in STANDBY until either the first unit operation is switched off or the mode is selected to be same as the first unit.

CONSTRUCTION AND DIMENSIONAL DIAGRAM FOR INDOOR

MODEL RAD-18RPA, RAD-25RPA, RAD-35RPA, RAD-50RPA*

Unit: mm

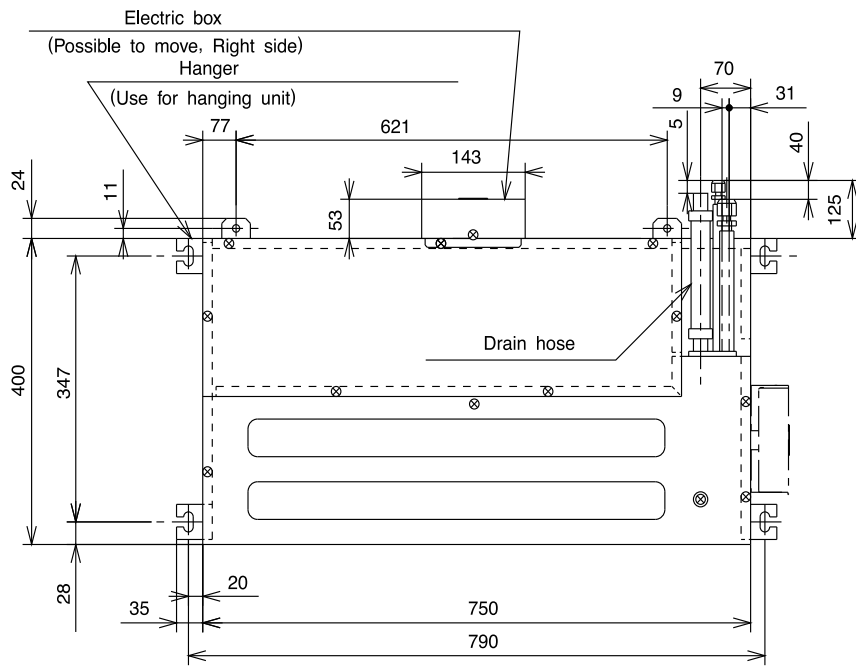

OPTIONAL
Wired Remote Controller
(SPX-RCDA)

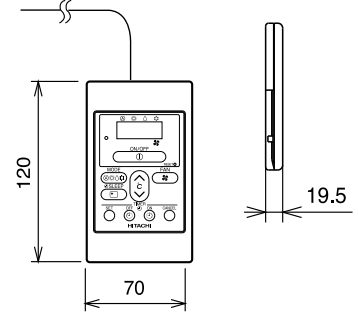

OPTIONAL
Wireless Remote Controller
(SPX-RCKA)

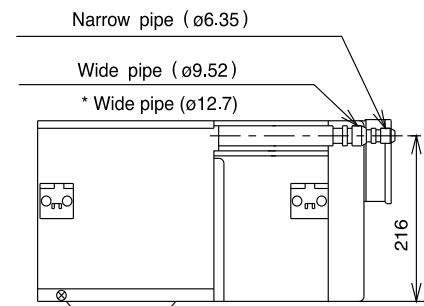
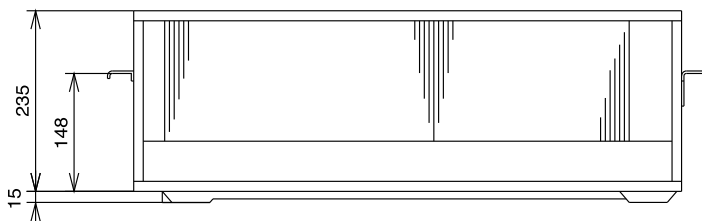
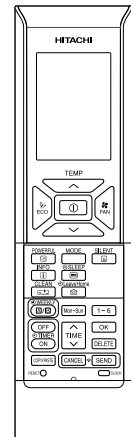

BACK SUCTION

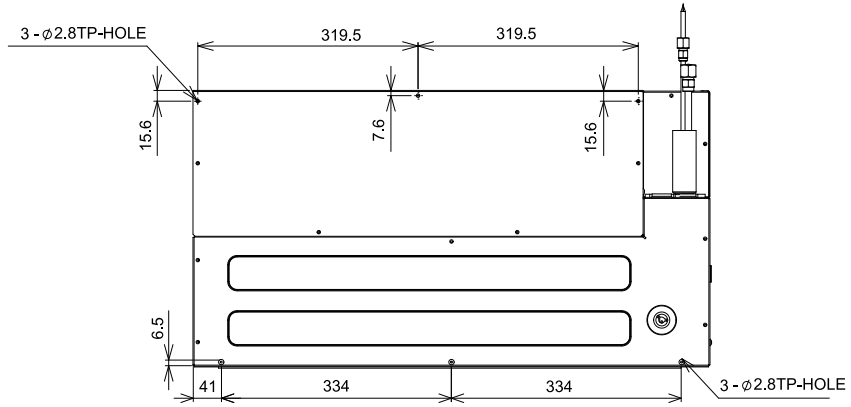
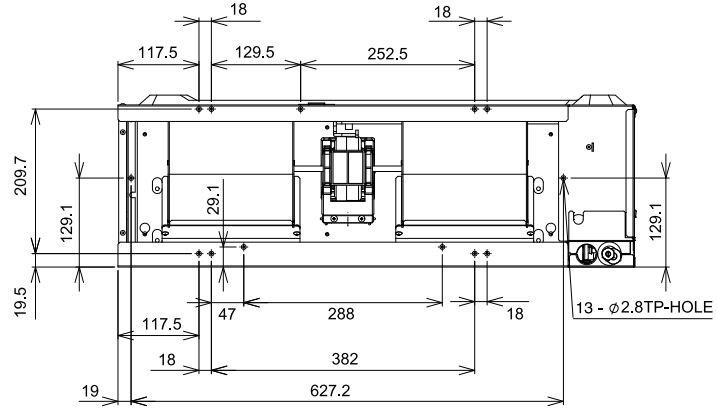

DISCHARGE

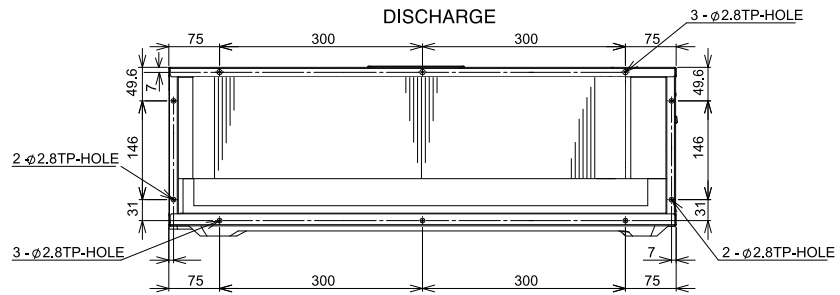

BOTTOM SUCTION

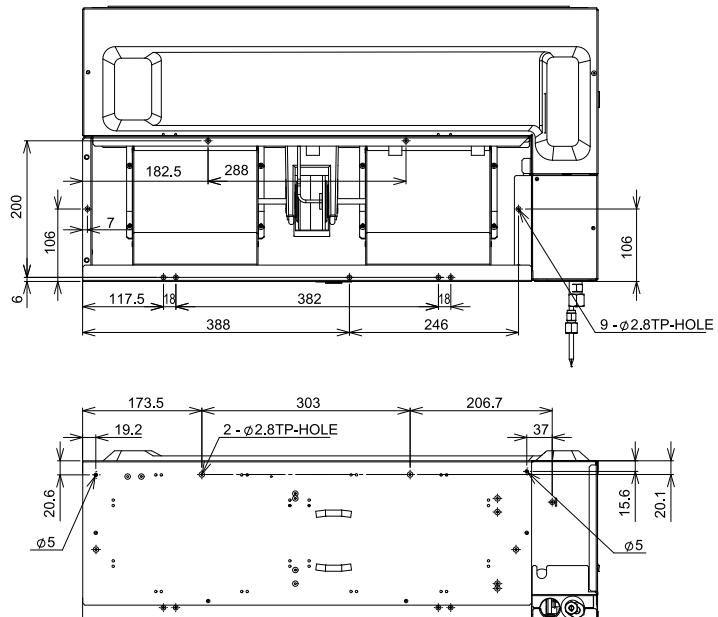

Cautions:

1. Use insulated pipes for both large and small diameters.

CONSTRUCTION AND DIMENSIONAL DIAGRAM FOR OUTDOOR

MODEL RAC-25NPA, RAC-35NPA

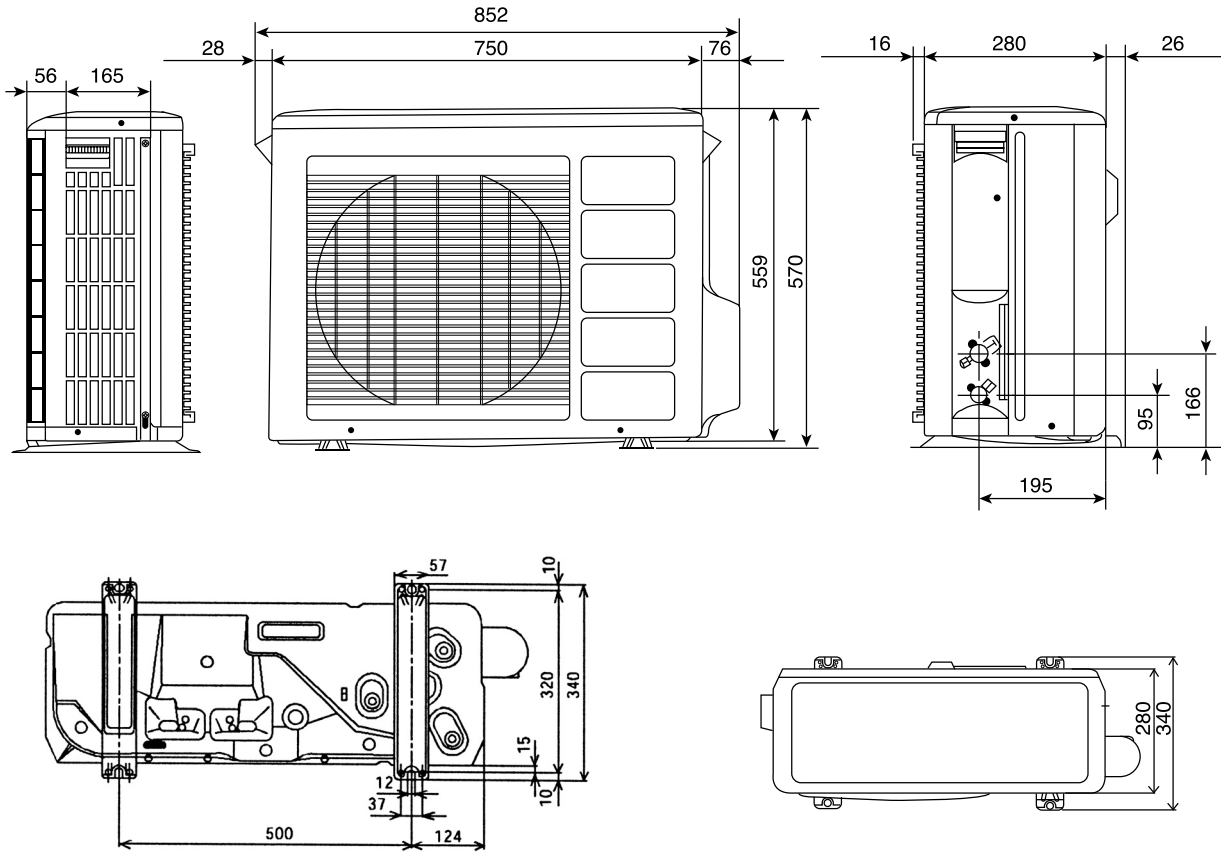

MODEL RAC-50NPA

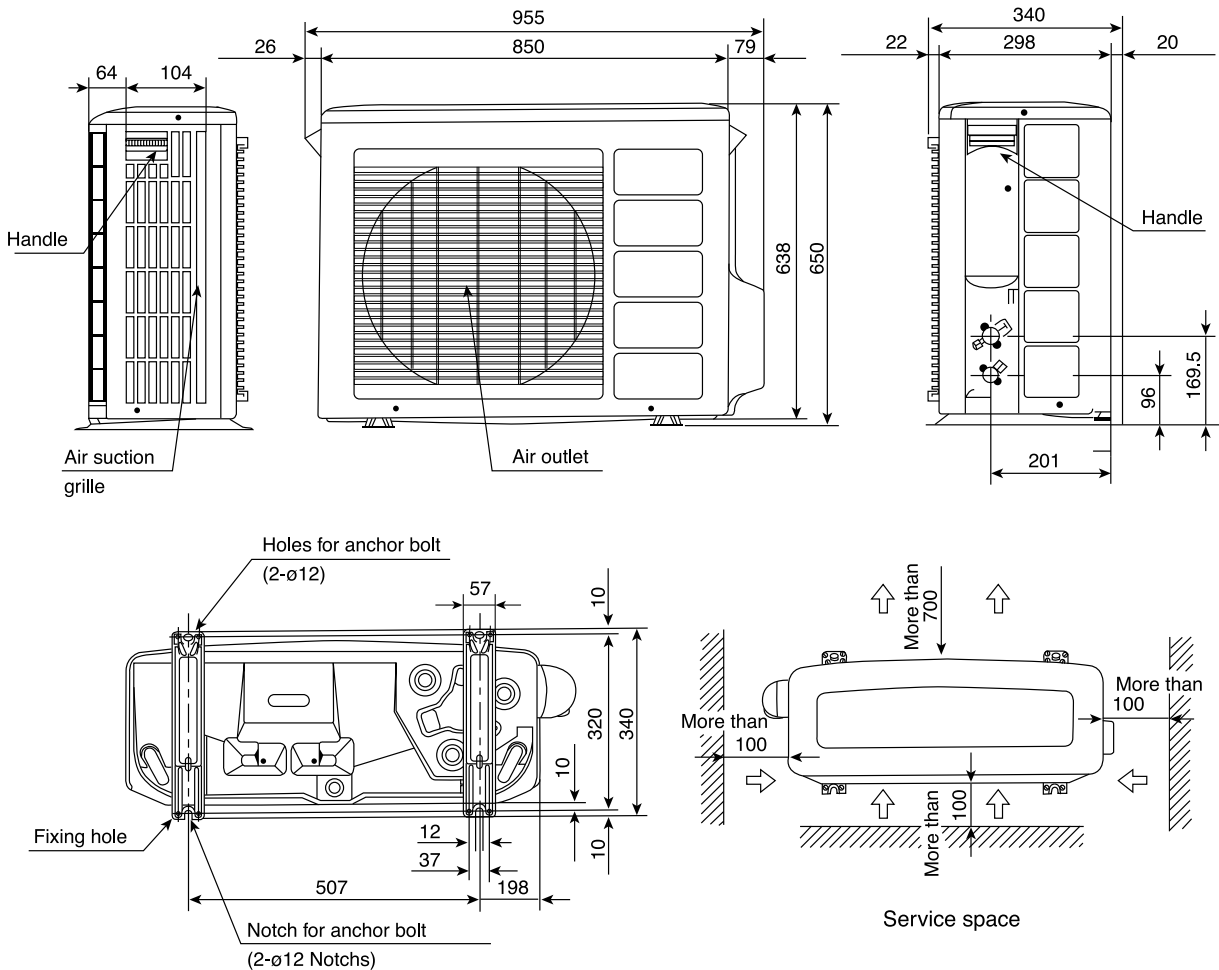

MAIN PARTS COMPONENT

THERMOSTAT

Thermostat Specifications

MODEL			RAD-18RPA, RAD-25RPA, RAD-35RPA, RAD-50RPA	
THERMOSTAT MODEL			IC	
OPERATION MODE			COOL	HEAT
TEMPERATURE °C (°F)	INDICATION 16	ON	14.9 (59.3)	20.4 (68.8)
		OFF	14.3 (58.3)	21.0 (69.1)
	INDICATION 24	ON	22.9 (73.7)	28.4 (83.1)
		OFF	22.3 (72.7)	29.0 (84.1)
	INDICATION 32	ON	30.9 (88.1)	36.4 (97.7)
		OFF	30.3 (87.1)	37.0 (98.8)

FAN MOTOR

Fan Motor Specifications

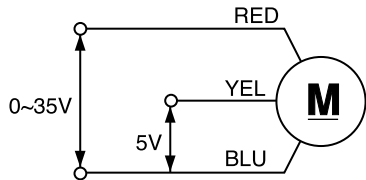
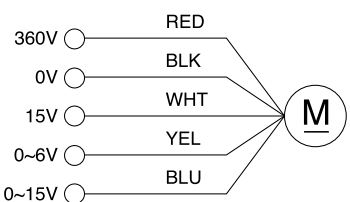
MODEL	RAD-18RPA, RAD-25RPA, RAD-35RPA, RAD-50RPA	RAC-25NPA, RAC-35NPA, RAC-50NPA
POWER SOURCE	DC: 0 ~ 35V	DC360V
OUTPUT	20W	40W
CONNECTION		

BLU : BLUE

YEL : YELLOW

BRN : BROWN

WHT : WHITE

GRY : GRAY

ORN : ORANGE

GRN : GREEN

RED : RED

BLK : BLACK

PNK : PINK

VIO : VIOLET

COMPRESSOR MOTOR

Compressor Motor Specifications

MODEL		RAC-25NPA/RAC-35NPA	RAC-50NPA
COMPRESSOR MODEL		JU1012D	JU1013D
PHASE		SINGLE	
RATED VOLTAGE		AC 220 ~ 240 V	
RATED FREQUENCY		50 Hz	
POLE NUMBER		4	
CONNECTION			
RESISTANCE VALUE (Ω)	20°C (68°F)	2M = 1.05	
	75°C (167°F)	2M = 1.28	

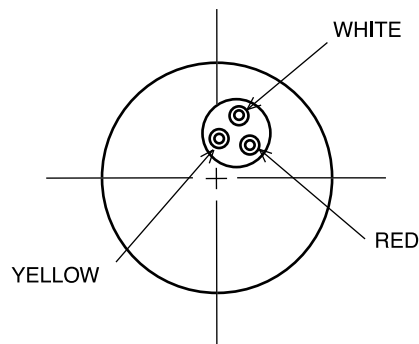

CAUTION

When the refrigerating cycle has been operated for a long time with the capillary tubes clogged or crushed or with too little refrigerant, check the color of the refrigerating machine oil inside the compressor. If the color has been changed conspicuously, replace the compressor.

WIRING DIAGRAM

MODEL RAD-18RPA, RAD-25RPA, RAD-35RPA, RAD-50RPA
 RAC-25NPA, RAC-35NPA, RAC-50NPA

BLU : BLUE
 GRY : GRAY
 BLK : BLACK

YEL : YELLOW
 ORN : ORANGE
 PNK : PINK

BRN : BROWN
 GRN : GREEN
 VIO : VIOLET

WHT : WHITE
 RED : RED

OUTDOOR UNIT

INDOOR UNIT

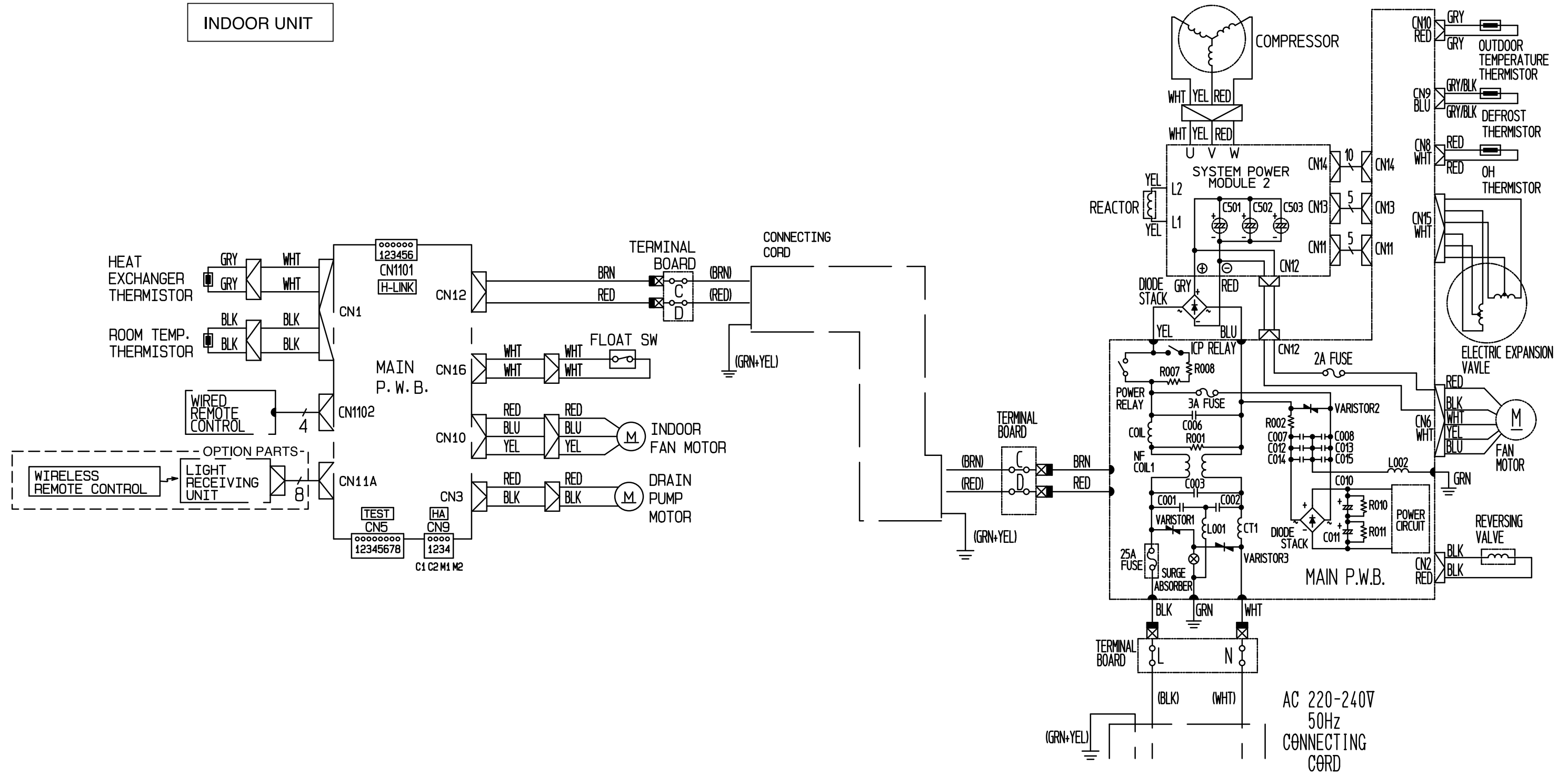

AC 220-240V
 50Hz
 CONNECTING
 CORD

CIRCUIT DIAGRAM

Wired Remote Controller

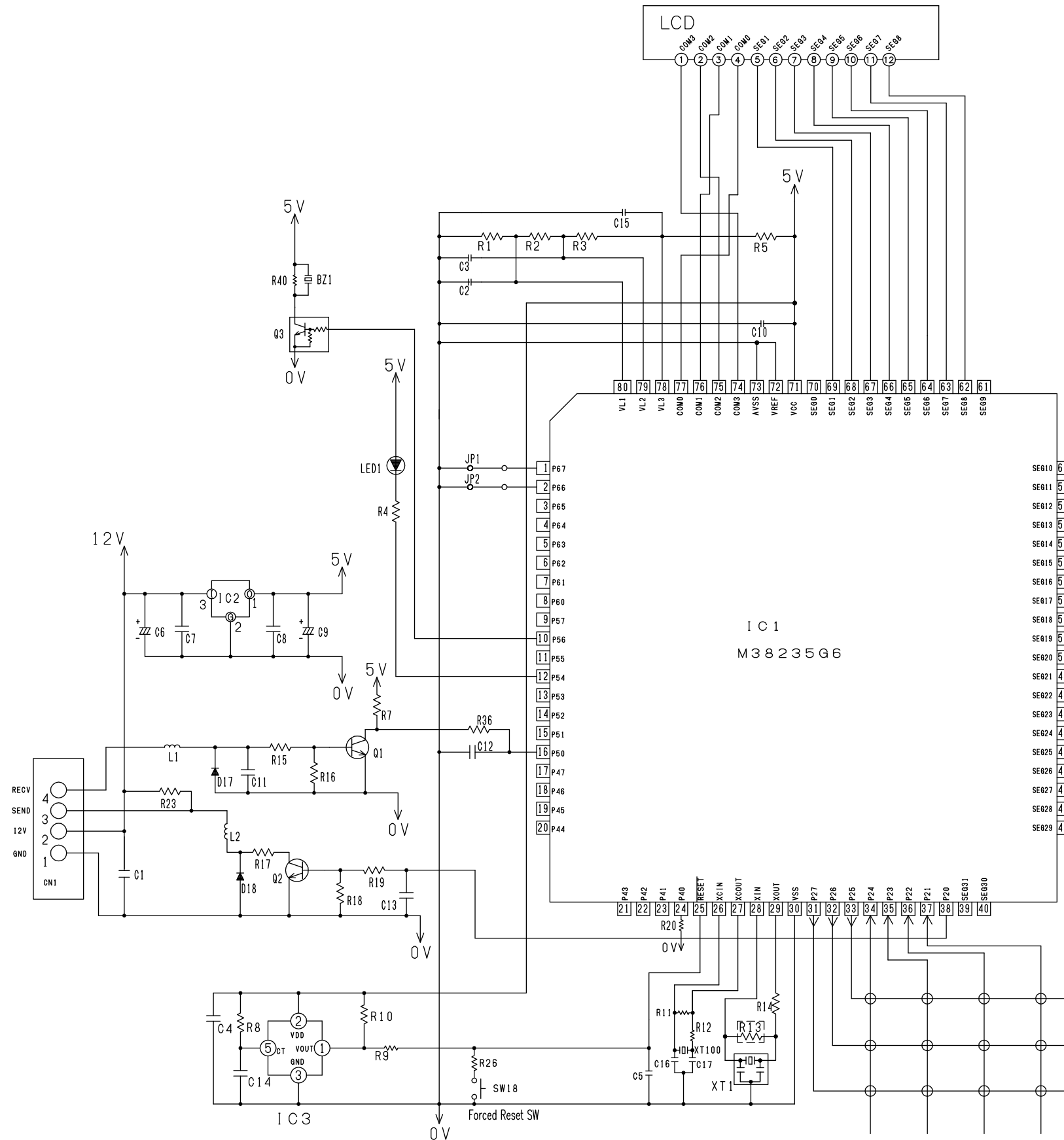

Resistor

symbol	resistance (Ω)	tolerance	power rating (W)	mounting form	surface	remark
R1	220k	5%	1/10	C	A	1608
R2	220k	5%	1/10	C	A	1608
R3	220k	5%	1/10	C	A	1608
R4	1k	5%	1/10	C	A	1608
R5	430k	5%	1/10	C	A	1608
R7	10k	5%	1/10	C	A	1608
R8	No Mount		1/10	C	A	1608
R9	1k	5%	1/10	C	A	1608
R10	300k	5%	1/10	C	A	1608
R11	10M	5%	1/10	C	A	1608
R12	220k	5%	1/10	C	A	1608
R13	No Mount		1/10	C	A	1608
R14	0	5%	1/10	C	A	1608
R15	10k	5%	1/10	C	A	1608
R16	10k	5%	1/10	C	A	1608
R17	0	5%	1/10	C	A	1608
R18	10k	5%	1/10	C	A	1608
R19	10k	5%	1/10	C	A	1608
R20	4.7k	5%	1/10	C	A	1608
R23	10k	5%	1/10	C	A	1608
R26	1k	5%	1/10	C	A	1608
R36	1k	5%	1/10	C	A	1608
R40	No Mount		1/10	C	A	1608
JP1	No Mount		1/10	C	A	1608
JP2	No Mount		1/10	C	A	1608

Capacitor

symbol	capacitance (µF)	rated voltage (V)	type	mounting form	surface	remark	temperature compensating
C1	0.1	25	C	C	A	1608	B
C2	0.1	25	C	C	A	1608	B
C3	0.1	25	C	C	A	1608	B
C4	0.1	25	C	C	A	1608	B
C5	0.1	25	C	C	A	1608	B
C6	10	25	D	C	A		
C7	0.1	25	C	C	A	1608	B
C8	0.1	25	C	C	A	1608	B
C9	10	25	D	C	A		
C10	1	16	C	C	A	1608	B
C11	470p	50	C	C	A	1608	B
C12	470p	50	C	C	A	1608	B
C13	470p	50	C	C	A	1608	B
C14	0.01	50	C	C	A	1608	B
C15	0.1	25	C	C	A	1608	B
C16	18p	50	C	C	A	1608	CH
C17	22p	50	C	C	A	1608	CH

表1 キーマトリックス表

Table1. Key-matrix table

Output \ Input	P21	P22	P23	P24
P25	(自動風向) (Auto lower)	取消 Cancel	風速切換 Wind speed select	予約 Book
P26	切タイマー Off	入タイマー On	温度 Temperature up	温度 Temperature down
P27	運転/停止 Start/Stop	—	おやすみ Sleep	運転切換 Drive mode select

Diode

symbol	product name	mounting form	surface
D17	1SS355	C	A
D18	1SS355	C	A

LED

symbol	product name	mounting form	surface
LED1	SML-811WT (A)	C	A

IC

symbol	product name	mounting form	surface
IC1	M38235G6-105HP	C	A
IC2	NJM78L05UA	C	A
IC3	S-80942CNMC-69CT2G	C	A

Coil

symbol	product name	mounting form	surface
L1	BLM18AG102SN1D	C	A
L2	BLM18AG102SN1D	C	A

Transistor

symbol	product name	mounting form	surface
Q1	2SC2412K	C	A
Q2	2SC2412K	C	A
Q3	No Mount	C	A

Resonators

symbol	product name	mounting form	surface
XT100	CFS2063276	H	A
XT1	CSTCR4M00G55-R0	C	A

Connector

symbol	product name	mounting form	surface
CN1	S4B-ZR-SM4A-TF	C	A

Buzzer

symbol	product name	mounting form	surface
BZ1	NO MOUNT	C	B

CIRCUIT DIAGRAM

Wireless Remote Controller

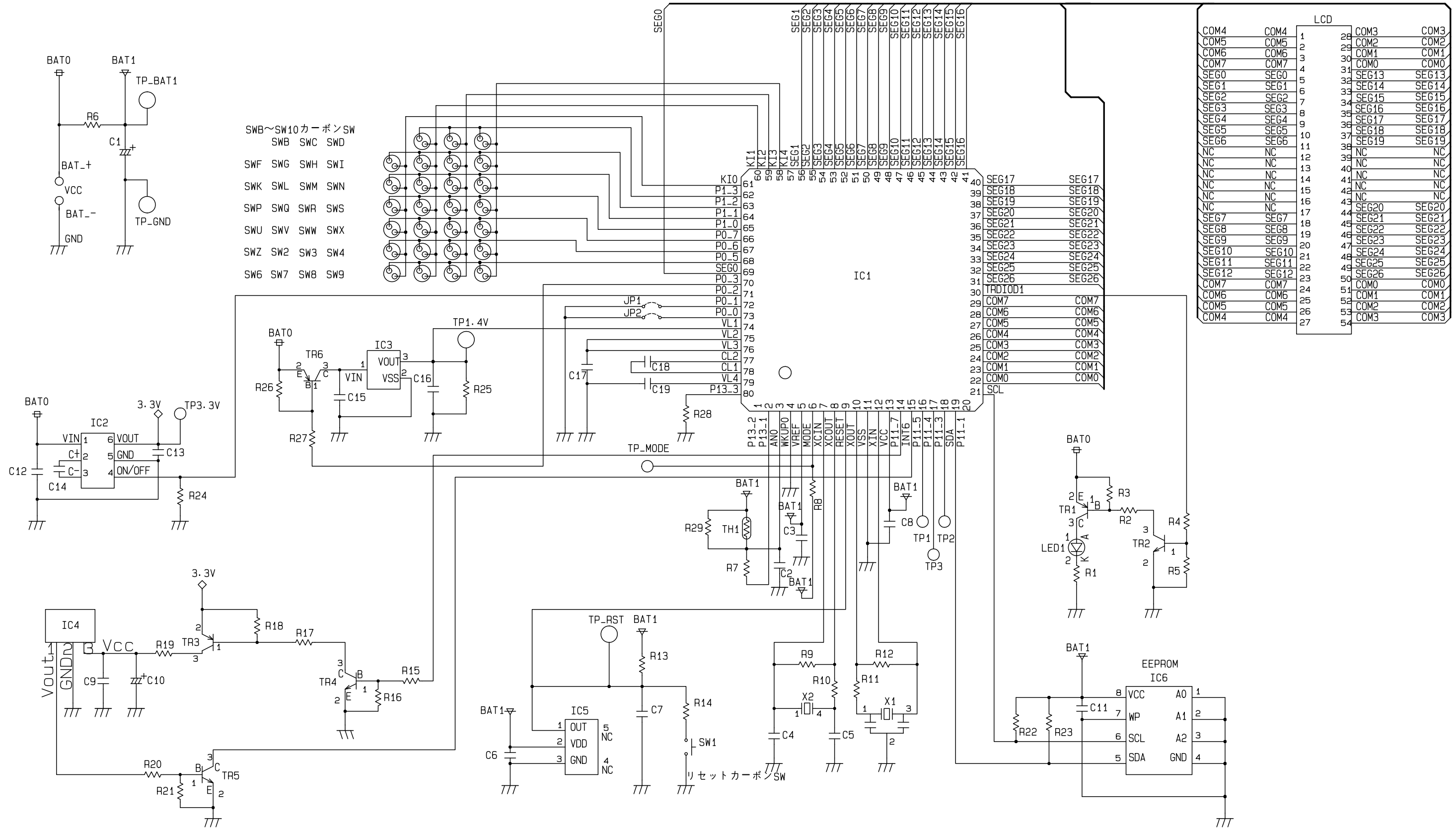

LCD			
COM4	COM4	1	26
COM5	COM5	2	29
COM6	COM6	3	30
COM7	COM7	4	34
SEG0	SEG0	5	34
SEG1	SEG1	6	34
SEG2	SEG2	7	34
SEG3	SEG3	8	36
SEG4	SEG4	9	36
SEG5	SEG5	10	36
SEG6	SEG6	11	37
NC	NC	12	38
NC	NC	13	39
NC	NC	14	40
NC	NC	15	41
NC	NC	16	43
NC	NC	17	44
SEG7	SEG7	18	45
SEG8	SEG8	19	46
SEG9	SEG9	20	47
SEG10	SEG10	21	48
SEG11	SEG11	22	48
SEG12	SEG12	23	49
COM7	COM7	24	51
COM6	COM6	25	51
COM5	COM5	26	53
COM4	COM4	27	54
COM3	COM3	28	54
COM2	COM2	29	54
COM1	COM1	30	54
COM0	COM0	31	54
SEG13	SEG13	32	54
SEG14	SEG14	33	54
SEG15	SEG15	34	54
SEG16	SEG16	35	54
SEG17	SEG17	36	54
SEG18	SEG18	37	54
SEG19	SEG19	38	54
SEG20	SEG20	39	54
SEG21	SEG21	40	54
SEG22	SEG22	41	54
SEG23	SEG23	42	54
SEG24	SEG24	43	54
SEG25	SEG25	44	54
SEG26	SEG26	45	54

CIRCUIT DIAGRAM
 MODEL RAD-18RPA, RAD-25RPA, RAD-35RPA, RAD-50RPA

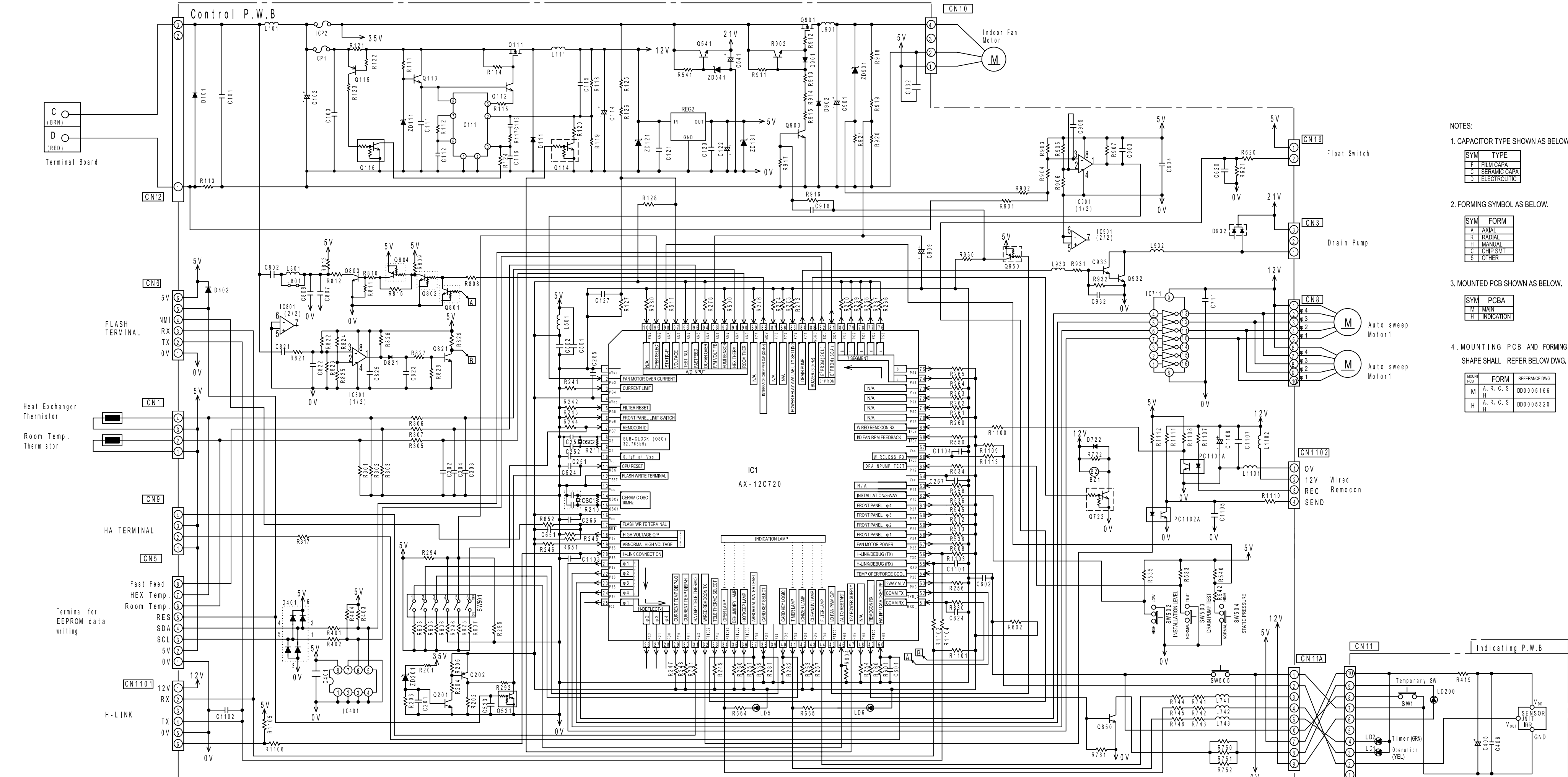

- NOTES:
- CAPACITOR TYPE SHOWN AS BELOW.
- | SYM | TYPE |
|-----|--------------|
| F | FILM CAPA |
| C | CERAMIC CAPA |
| D | ELECTROLYTIC |
- FORMING SYMBOL AS BELOW.
- | SYM | FORM |
|-----|----------|
| A | AXIAL |
| R | RADIAL |
| H | MANUAL |
| C | CHIP SMT |
| S | OTHER |
- MOUNTED PCB SHOWN AS BELOW.
- | SYM | PCBA |
|-----|------------|
| M | MAIN |
| H | INDICATION |
- MOUNTING PCB AND FORMING SHAPE SHALL REFER BELOW DWG.
- | INDIC | FORM | REFERENCE DWG |
|-------|------------|---------------|
| M | A, R, C, S | DD0005186 |
| H | A, R, C, S | DD0005320 |

RESISTOR

SYMBOL	VALUE (Ω)	TOL.	POWER (W)	FORM	PCBA	ASSEMBLY	REF. PART NO.
R101	27k	5%	1/16W	C	M	17	1802
R102	10k	5%	1/16W	C	M	17	1802
R103	10k	5%	1/16W	C	M	17	1802
R104	10k	5%	1/16W	C	M	17	1802
R105	10k	5%	1/16W	C	M	17	1802
R106	10k	5%	1/16W	C	M	17	1802
R107	10k	5%	1/16W	C	M	17	1802
R108	10k	5%	1/16W	C	M	17	1802
R109	10k	5%	1/16W	C	M	17	1802
R110	10k	5%	1/16W	C	M	17	1802

CAPACITOR

SYMBOL	VALUE (μF)	TOL.	POWER (W)	FORM	PCBA	ASSEMBLY	REF. PART NO.
C101	0.1	5%		C	M	17	1802
C102	0.1	5%		C	M	17	1802
C103	0.1	5%		C	M	17	1802
C104	0.1	5%		C	M	17	1802
C105	0.1	5%		C	M	17	1802
C106	0.1	5%		C	M	17	1802
C107	0.1	5%		C	M	17	1802
C108	0.1	5%		C	M	17	1802
C109	0.1	5%		C	M	17	1802
C110	0.1	5%		C	M	17	1802

DIODE

SYMBOL	MODEL NAME	FORM	PCBA	ASSEMBLY	REF. PART NO.
D101	1N4148	C	M	17	1802
D102	1N4148	C	M	17	1802
D103	1N4148	C	M	17	1802
D104	1N4148	C	M	17	1802
D105	1N4148	C	M	17	1802
D106	1N4148	C	M	17	1802
D107	1N4148	C	M	17	1802
D108	1N4148	C	M	17	1802
D109	1N4148	C	M	17	1802
D110	1N4148	C	M	17	1802

ZENER DIODE

SYMBOL	MODEL NAME	FORM	PCBA	ASSEMBLY	REF. PART NO.
Z101	5.1	C	M	17	1802
Z102	5.1	C	M	17	1802
Z103	5.1	C	M	17	1802
Z104	5.1	C	M	17	1802
Z105	5.1	C	M	17	1802
Z106	5.1	C	M	17	1802
Z107	5.1	C	M	17	1802
Z108	5.1	C	M	17	1802
Z109	5.1	C	M	17	1802
Z110	5.1	C	M	17	1802

TRANSISTOR

SYMBOL	MODEL NAME	FORM	PCBA	ASSEMBLY	REF. PART NO.
Q101	2N2222	C	M	17	1802
Q102	2N2222	C	M	17	1802
Q103	2N2222	C	M	17	1802
Q104	2N2222	C	M	17	1802
Q105	2N2222	C	M	17	1802
Q106	2N2222	C	M	17	1802
Q107	2N2222	C	M	17	1802
Q108	2N2222	C	M	17	1802
Q109	2N2222	C	M	17	1802
Q110	2N2222	C	M	17	1802

IC

SYMBOL	MODEL NAME	FORM	PCBA	ASSEMBLY	REF. PART NO.
IC101	74LS00	C	M	17	1802
IC102	74LS00	C	M	17	1802
IC103	74LS00	C	M	17	1802
IC104	74LS00	C	M	17	1802
IC105	74LS00	C	M	17	1802
IC106	74LS00	C	M	17	1802
IC107	74LS00	C	M	17	1802
IC108	74LS00	C	M	17	1802
IC109	74LS00	C	M	17	1802
IC110	74LS00	C	M	17	1802

OSCILLATOR

SYMBOL	MODEL NAME	FORM	PCBA	ASSEMBLY	REF. PART NO.
OS101	IC901	C	M	17	1802
OS102	IC901	C	M	17	1802
OS103	IC901	C	M	17	1802
OS104	IC901	C	M	17	1802
OS105	IC901	C	M	17	1802
OS106	IC901	C	M	17	1802
OS107	IC901	C	M	17	1802
OS108	IC901	C	M	17	1802
OS109	IC901	C	M	17	1802
OS110	IC901	C	M	17	1802

CONNECTOR

SYMBOL	MODEL NAME	FORM	PCBA	ASSEMBLY	REF. PART NO.
CN101	B4B-PK-K-3	H	M	17	1802
CN102	B4B-PK-K-3	H	M	17	1802
CN103	B4B-PK-K-3	H	M	17	1802
CN104	B4B-PK-K-3	H	M	17	1802
CN105	B4B-PK-K-3	H	M	17	1802
CN106	B4B-PK-K-3	H	M	17	1802
CN107	B4B-PK-K-3	H	M	17	1802
CN108	B4B-PK-K-3	H	M	17	1802
CN109	B4B-PK-K-3	H	M	17	1802
CN110	B4B-PK-K-3	H	M	17	1802

IR RECEIVER

SYMBOL	MODEL NAME	FORM	PCBA	ASSEMBLY	REF. PART NO.
IR101	HS-3033	C	M	17	1802
IR102	HS-3033	C	M	17	1802
IR103	HS-3033	C	M	17	1802
IR104	HS-3033	C	M	17	1802
IR105	HS-3033	C	M	17	1802
IR106	HS-3033	C	M	17	1802
IR107	HS-3033	C	M	17	1802
IR108	HS-3033	C	M	17	1802
IR109	HS-3033	C	M	17	1802
IR110	HS-3033	C	M	17	1802

BUZZER

SYMBOL	MODEL NAME	FORM	PCBA	ASSEMBLY	REF. PART NO.
BZ101	BUZZER	C	M	17	1802
BZ102	BUZZER	C	M	17	1802
BZ103	BUZZER	C	M	17	1802
BZ104	BUZZER	C	M	17	1802
BZ105	BUZZER	C	M	17	1802
BZ106	BUZZER	C	M	17	1802
BZ107	BUZZER	C	M	17	1802
BZ108	BUZZER	C	M	17	1802
BZ109	BUZZER	C	M	17	1802
BZ110	BUZZER	C	M	17	1802

Table 1. DSW1 (explanation of detail function)

No.	Content	Switch condition/function
1	Auto reset	OFF
2	Auto stop	OFF
3	Auto start	ON
4	Auto stop	OFF
5	Auto start	ON
6	Auto stop	OFF
7	Auto start	ON
8	Auto stop	OFF
9	Auto start	ON
10	Auto stop	OFF

BLOCK DIAGRAM

MODEL RAD-18RPA, RAD-25RPA, RAD-35RPA, RAD-50RPA
 RAC-25NPA, RAC-35NPA, RAC-50NPA

INDOOR UNIT

OUTDOOR UNIT

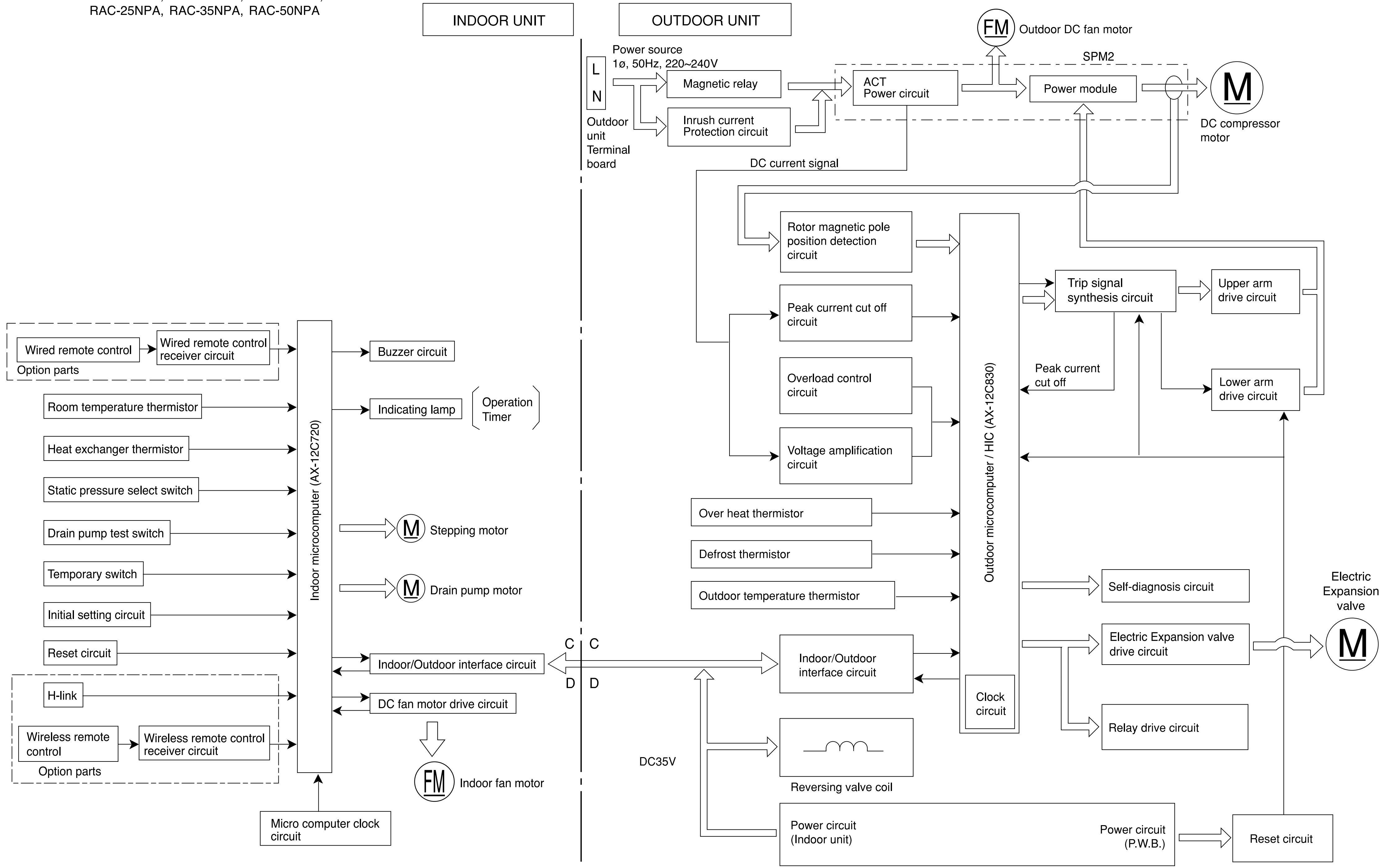

BASIC MODE

MODEL RAD-18RPA, RAD-25RPA, RAD-35RPA, RAD-50RPA

Operation mode		Fan	Cooling	Dehumidifying (dehumidifying operation by the function select button only, not including that engaged by the dehumidify button)	Heating	Auto									
Basic operation of start/stop switch															
Timer functions	Off-timer														
	On-timer														
	Off -> On On -> Off timer														
Fan speed mode (indoor fan)	Auto	<p>Changes from "Hi" to "Med" or "Lo" depending on room temperature.</p> <ol style="list-style-type: none"> Runs at "Hi" until first thermo off after operation is started. Runs at "Lo" when thermo is off. 	<p>Changes between "Lo" and "Med" depending on the room temperature.</p> <table border="1"> <thead> <tr> <th>Temperature division</th> <th>Fan speed</th> </tr> </thead> <tbody> <tr> <td>Division 1</td> <td>Lo</td> </tr> <tr> <td>Division 2</td> <td>Lo</td> </tr> <tr> <td>Division 3</td> <td>Med</td> </tr> <tr> <td>Division 4</td> <td>Med</td> </tr> </tbody> </table> <p>1. The indoor fan also stops when the compressor is in stop status.</p>	Temperature division	Fan speed	Division 1	Lo	Division 2	Lo	Division 3	Med	Division 4	Med	<p>Set to "ultra-Lo", "Lo", "Med", "Hi", "ultra-Hi" or "stop" depending on the room temperature, time and heat exchange temperature. Set to "stop" if the room temperature is 18°C in the "ultra-Lo" mode other than during preheating (cooling is recovered at 18.33°C).</p> <p>When the compressor is running at maximum speed during hot dash or when recovered from defrosting.</p> <p>In modes other than left</p>	<p>Operating mode is judged by room temperature and outdoor temperature.</p> <p>(1) Judging by outdoor temperature</p> <ul style="list-style-type: none"> Operating mode is judged by outdoor temperature. Only when the mode is not restricted by this judgment, the judgment by room temperature in the next paragraph will be performed. <ul style="list-style-type: none"> (a) Outdoor temperature $\geq 27^\circ\text{C}$: Restricted to cooling (b) Outdoor temperature $\leq 16^\circ\text{C}$: Restricted to heating <p>(2) Judging by room temperature</p> <p>Operating mode at start up is judged (initial judgment)</p> <p>(a) Conditions for judgment (any of the followings)</p> <ul style="list-style-type: none"> When auto operation is started after 1 hour has elapsed since the operation was stopped. When auto operation is started after the previous manual mode operation. When the operating mode is switched to auto while operating at manual mode. <p>(b) Judging method</p> <ul style="list-style-type: none"> Room temperature $\geq 25^\circ\text{C} \pm 3^\circ\text{C}$: Cooling Room temperature $< 25^\circ\text{C} \pm 3^\circ\text{C}$: Heating <p>* $\pm 3^\circ\text{C}$ is the fine adjustment value from the wireless remote controller.</p>
	Temperature division	Fan speed													
	Division 1	Lo													
	Division 2	Lo													
	Division 3	Med													
Division 4	Med														
Hi	Operates at "Hi" regardless of the room temperature.	Set to "ultra-Hi" when the compressor runs at maximum speed, and to "Hi" in other modes.	Set to "Hi" in modes other than when the compressor stops.	Set to "ultra-Lo", "Lo", "Med", "Hi", "ultra-Hi" or "stop" depending on the room temperature, and time. Set to "stop" if the room temperature is 18°C in the "ultra-Lo" mode other than during preheating (cooling is recovered at 18.33°C). Set to "ultra-Hi" when the compressor is running at maximum speed during hot dash or when recovered from defrosting.											
Med	Operates at "Med" regardless of the room temperature.	Same as at left.	Set to "Med" in modes other than when the compressor stops.	Set to "ultra-Lo", "Lo", "Med" or "stop" depending on the room temperature and time. Set to "stop" if the room temperature is 18°C in the "ultra-Lo" mode other than during preheating (cooling is recovered at 18.33°C).											
Lo	Operates at "Lo" regardless of the room temperature.	Same as at left.	Set to "Lo" in modes other than when the compressor stops.	Set to "ultra-Lo", "Lo", or "stop" depending on the room temperature and time. Set to "stop" if the room temperature is 18°C in the "ultra-Lo" mode other than during preheating (cooling is recovered at 18.33°C). The fan speed is controlled by the heat exchanger temperature; the overload control is executed as in the following diagram:											
Silent	Operates at "Silent" regardless of the room temperature.	Same as at left.	Set to "Silent" in modes other than when the compressor stops.												
Basic operation of temperature controller	Performs only fan operation at the set speed regardless of the room temperature.	See page 73.	See page 77.	See page 81.											
Sleep operation (with sleep button ON)	<ul style="list-style-type: none"> Enters sleep operation after set as on the left. Action during sleep operation Lo (sleep) operation 	<ul style="list-style-type: none"> Same as at left See page 75. 	<ul style="list-style-type: none"> Same as at left See page 79. 	<ul style="list-style-type: none"> Same as at left See page 83. 	<ul style="list-style-type: none"> Same as at left. Performs the sleep operation of each operation mode. 										

Table 1 Mode data file

	RAD-18RPA	RAD-25RPA	RAD-35RPA	RAD-50RPA
LABEL NAME	VALUE			
WMAX	4400 min ⁻¹	4400 min ⁻¹	5500 min ⁻¹	5300 min ⁻¹
WMAX2	4500 min ⁻¹	4400 min ⁻¹	5500 min ⁻¹	5300 min ⁻¹
WSTD	3500 min ⁻¹	3500 min ⁻¹	4950 min ⁻¹	5100 min ⁻¹
WBEMAX	3000 min ⁻¹	2800 min ⁻¹	2800 min ⁻¹	3500 min ⁻¹
CMAX	2700 min ⁻¹	2700 min ⁻¹	4400 min ⁻¹	5700 min ⁻¹
CSTD	2450 min ⁻¹	2450 min ⁻¹	4000 min ⁻¹	5500 min ⁻¹
CKYMAX_TY1	2200 min ⁻¹	2200 min ⁻¹	3500 min ⁻¹	3500 min ⁻¹
CJKMAX	1800 min ⁻¹	1800 min ⁻¹	2800 min ⁻¹	2700 min ⁻¹
CBEMAX	1600 min ⁻¹	1600 min ⁻¹	2200 min ⁻¹	2000 min ⁻¹
WMIN	1500 min ⁻¹	1500 min ⁻¹	1500 min ⁻¹	1800 min ⁻¹
CMIN	1500 min ⁻¹	1500 min ⁻¹	1500 min ⁻¹	1800 min ⁻¹
STARTMC	60 Seconds	60 Seconds	60 Seconds	60 Seconds
DWNRATEW	80%	80%	80%	80%
DWNRATEC	80%	80%	80%	80%
SHIFTW	5.00°C	5.00°C	5.00°C	5.00°C
SHIFTC	1.66°C	1.66°C	1.66°C	1.66°C
CLMXTP	30.00°C	30.00°C	30.00°C	30.00°C
YNEOF	20.00°C	20.00°C	20.00°C	20.00°C
TEION	0.00°C	0.00°C	0.00°C	0.00°C
TEIOF	9.00°C	9.00°C	9.00°C	9.00°C

Basic Cooling Operation

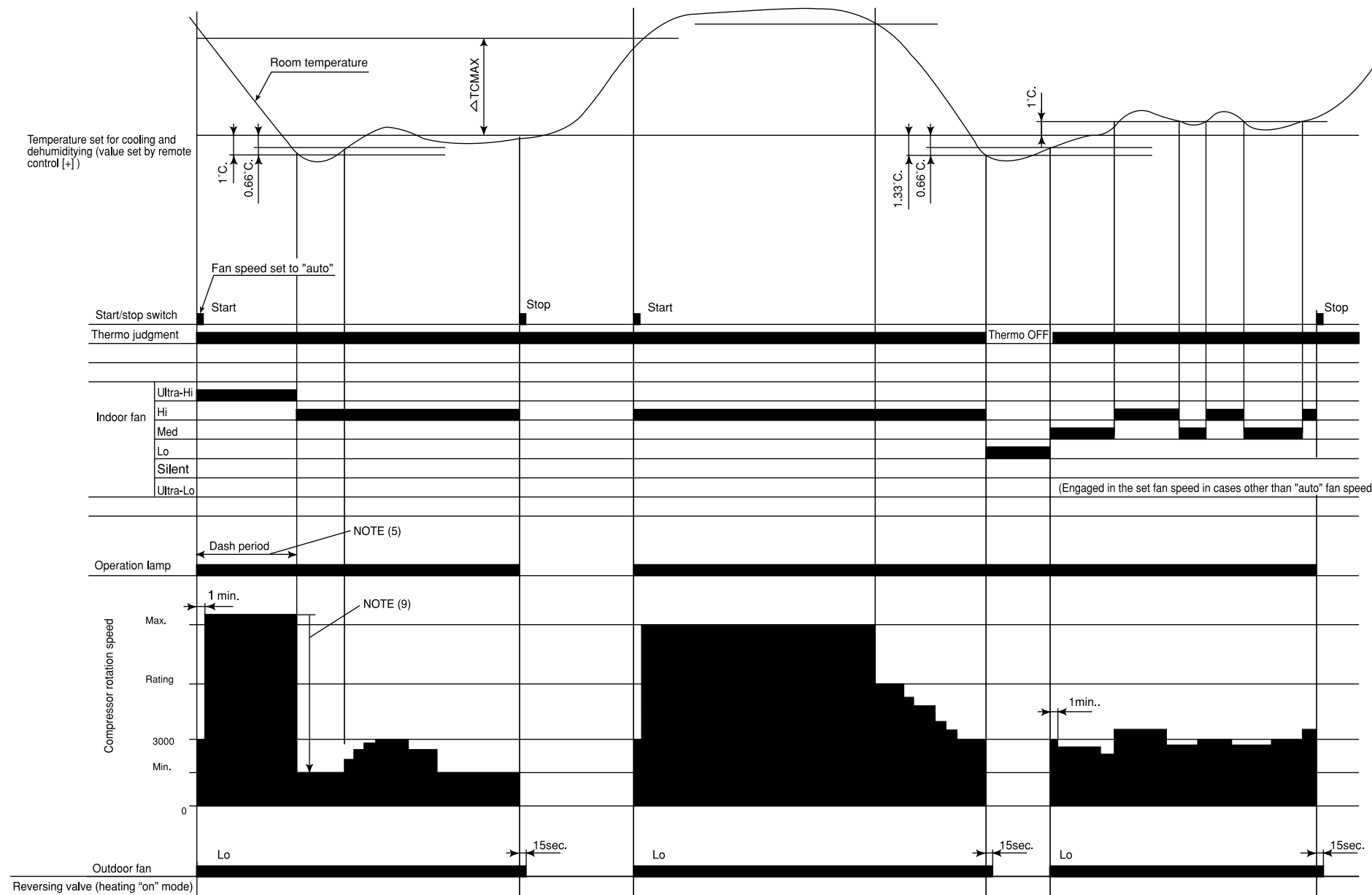

Notes:

- (1) Condition for entering into Cool Dashed mode. When fan set to “Hi” or “Auto mode” and temperature difference between indoor temperature and set temperature has a corresponding compressor rpm (calculated value in Table 2) larger than CMAX.
- (2) Cool Dashed will release when i) a maximum 25 minutes is lapsed and ii) room temperature is lower than set temperature -3°C (thermo off) and iii) when room temperature has achieved setting temperature -1°C then maximum Cool Dashed time will be revised to 20 minutes. And iv) indoor fan is set to Lo and Med fan mode and v) change operation mode.
- (3) During Cool Dashed operation, thermo off temperature is set temperature (with shift value) -3°C . After thermo off, operation continue in Fuzzy control mode.
- (4) Compressor minimum “ON” time and “OFF” time is 3 minutes.
- (5) During normal cooling mode, compressor maximum rpm CMAX will maintain for 60 minutes if indoor temperature is lower than CLMXTP. No time constrain if indoor temperature is higher than CLMXTP.
- (6) When fan is set to “Hi”, compressor rpm will be limited to CKYMAX-TY1.
- (7) When fan is set to “Med”, compressor rpm will be limited to CJKMAX.
- (8) When fan is set to “Lo”, compressor rpm will be limited to CBEMAX.
- (9) During Cool Dashed, when room temperature reaches set temperature -1°C compressor rpm is actual rpm x DWNRATEC.

Table 2 ΔTCMAX

Temperature difference	Calculated compressor rpm
1.66	2265 min^{-1}
2	2435 min^{-1}
2.33	2600 min^{-1}
2.66	2765 min^{-1}
3	2935 min^{-1}
3.33	3100 min^{-1}
3.66	3265 min^{-1}
4	3435 min^{-1}
4.33	3600 min^{-1}
4.66	3765 min^{-1}
5	3935 min^{-1}
5.33	4100 min^{-1}
5.66	4265 min^{-1}
6	4435 min^{-1}
6.33	4600 min^{-1}
6.66	4765 min^{-1}
7	4935 min^{-1}
7.33	5100 min^{-1}
7.66	5265 min^{-1}
8	5435 min^{-1}
8.33	5600 min^{-1}
8.66	5765 min^{-1}
9	5935 min^{-1}
9.33	6100 min^{-1}
9.66	6265 min^{-1}
10	6435 min^{-1}
10.33	6600 min^{-1}
10.66	6765 min^{-1}
11	6935 min^{-1}

Note:

1. See the data in Table 1 on page 71 for each constant in capital letters in the diagrams.

Cooling Defrost

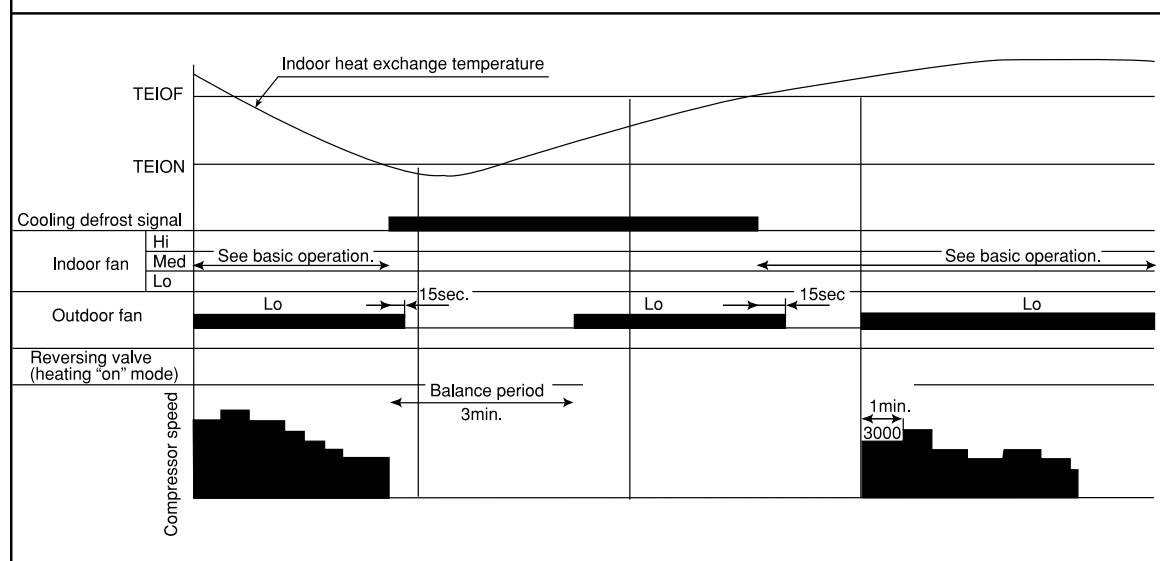

Cooling Powerful Operation

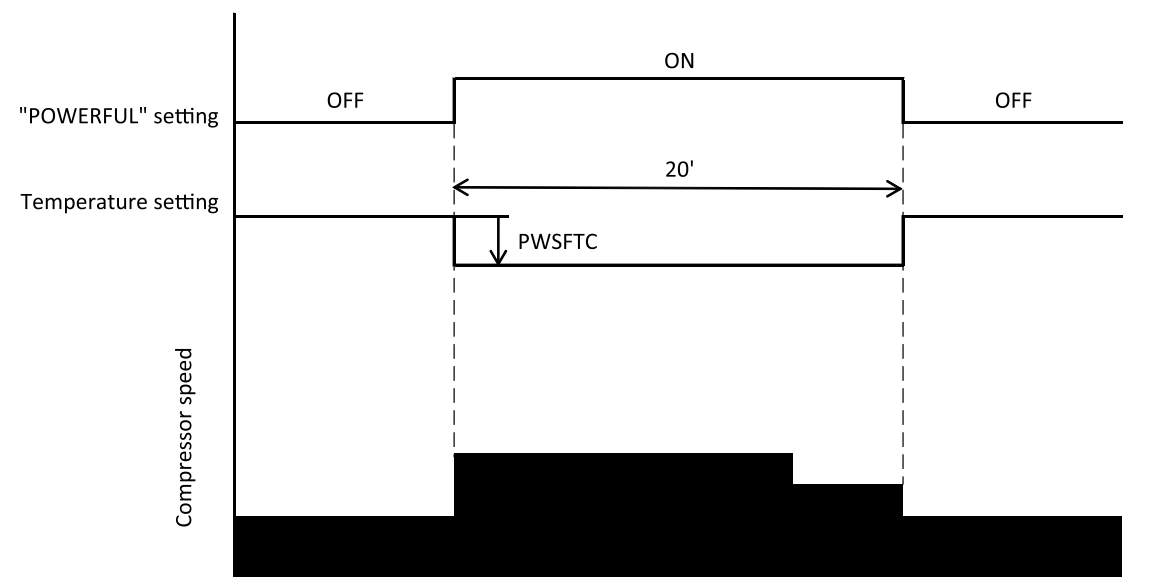

Notes :

- (1) Pressing the "POWERFUL" button will reduce the temperature setting by PWSFTC.
- (2) The powerful operation is for 20 minutes after setting.
- (3) Operation is continued forcibly thermo-ON for 20 minutes after the powerful operation is finished.
- (4) Pressing the "START/STOP" button and "POWERFUL" button during powerful operation will cancel the powerful operation.
- (5) If the sleep timer is set during powerful operation, the powerful operation will be canceled.
- (6) If the fan speed of the remote controller is set to "AUTO" or "HIGH", the compressor's maximum speed during powerful operation will be set to CMAX2. The lower limit speed is CKYMIN_PW.
- (7) If the fan speed of the remote controller is set to "MED", the compressor's maximum speed during powerful operation will be set to CJKMAX_PW. The lower limit speed is CJKMIN_PW.
- (8) If the fan speed of the remote controller is set to "LOW", the compressor's maximum speed during powerful operation will be set to CBEMAX_PW. The lower limit speed is CBEMIN_PW.
- (9) If the fan speed of the remote controller is set to "SILENT", the compressor's maximum speed during powerful operation will be set to CSZMAX_PW. The lower limit speed is CSZMIN_PW.
- (10) The fan speed increases by FNUPPW_C.

Cooling Sleep Operation

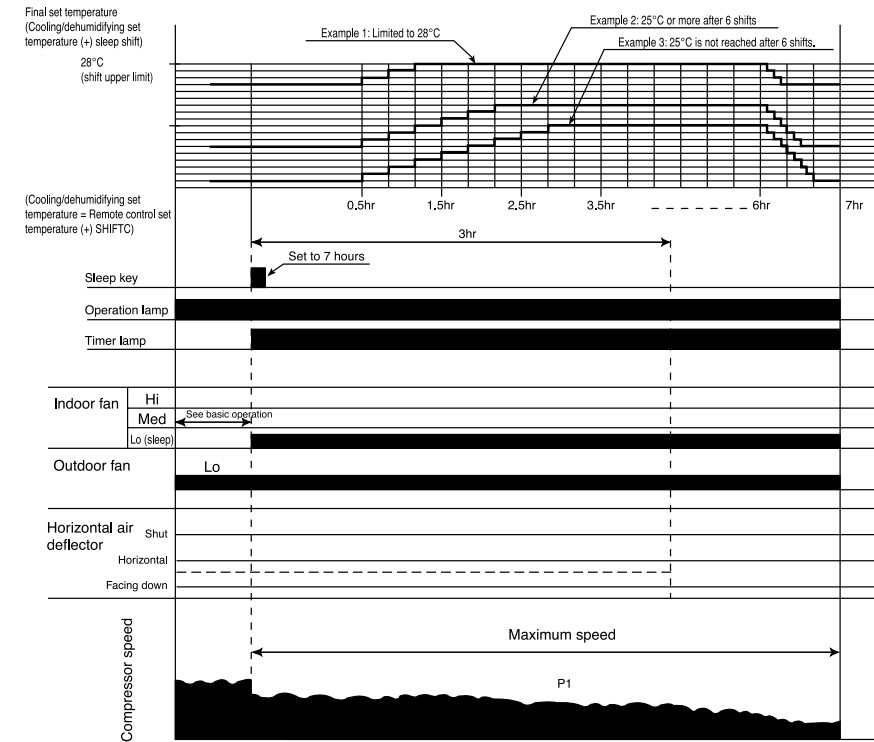

Notes:

- (1) The sleep operation starts when the sleep key is pressed.
- (2) When the sleep key is set, the maximum compressor speed is limited, and the indoor fan is set to "sleep Lo".
- (3) 30 minutes after the sleep key is set, the sleep shift of temperature starts, and upper shift is made at least 6 times. If 25°C is not reached after 6 shifts, shifts repeat until 25°C is reached.
- (4) The sleep shift upper value of set temperature is 28°C.
- (5) After 6 hours, a shift down to the initial set temperature is made at a rate of 0.33°C/5 min.
- (6) If the operation mode is changed during sleep operation, the set temperature is cleared, and shift starts from the point when switching is made.
- (7) The indoor fan speed does not change even when the fan speed mode is changed.
- (8) When operation is stopped during sleep operation, the set temperature when stopped, as well as the time, continue to be counted.
- (9) If the set time is changed during sleep operation, all data including set temperature, time, etc. is cleared and restarted.
- (10) If sleep operation is canceled by the cancel key or sleep key, all data is cleared.

Dehumidifying

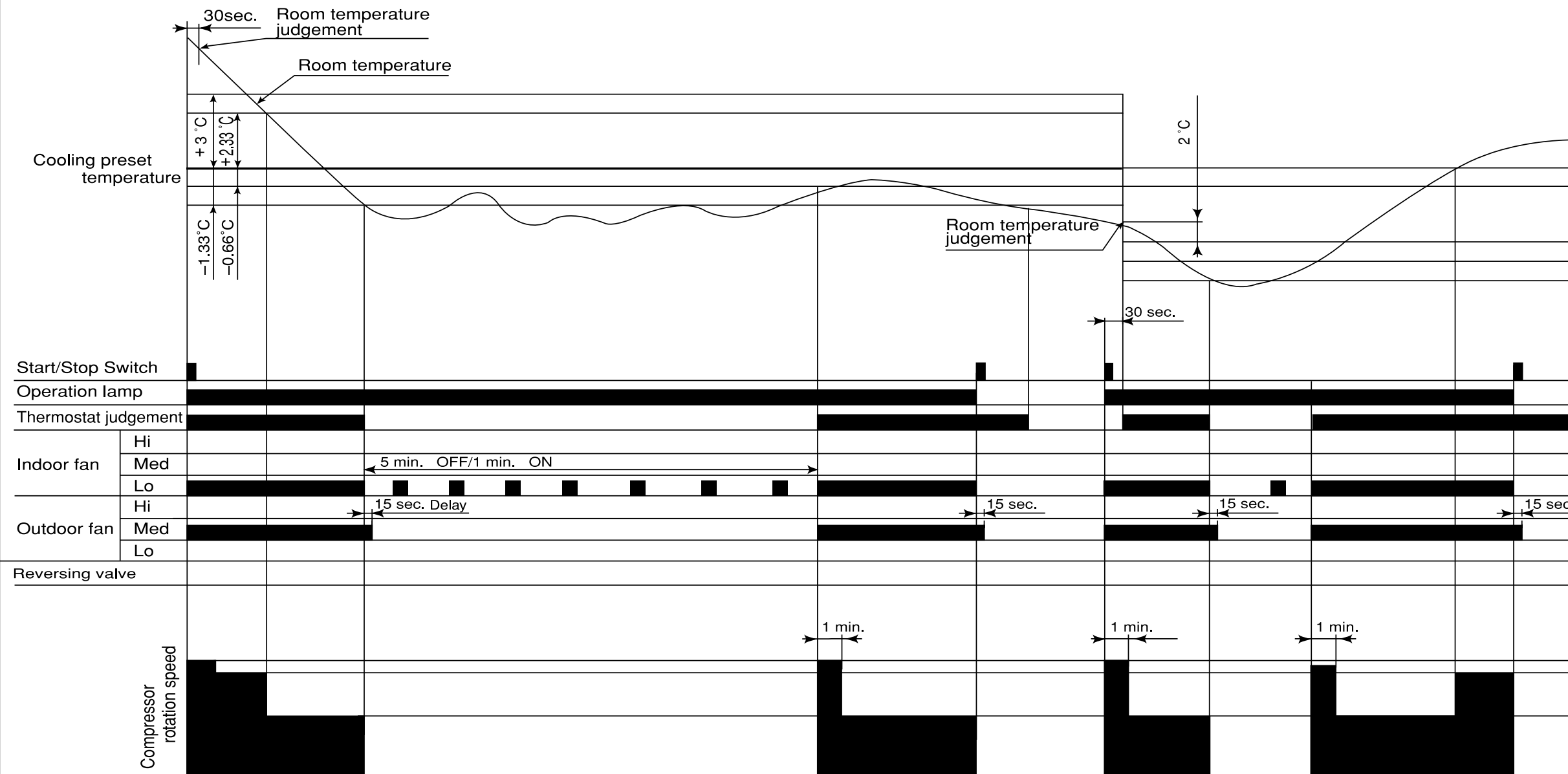

Notes:

- (1) If the room temperature is (cooling preset temperature) - (1.33°C) or less after 30 seconds from starting the operation, the operation is done assuming as the preset temperature = (room temperature at the time) - (2°C).
- (2) The indoor fan is operated in the "Lo" mode. During thermo OFF indoor fan will be OFF for 5 minutes and ON for 1 minute.
- (3) When the operation is started by the thermostat turning ON, the start of the indoor fan is delayed 32 seconds after the start of compressor operation.
- (4) The compressor is operated forcedly for 3 minutes after operation is started.
- (5) The minimum ON time and OFF time of the compressor are 3 minutes.

Dehumidifying Sleep Operation

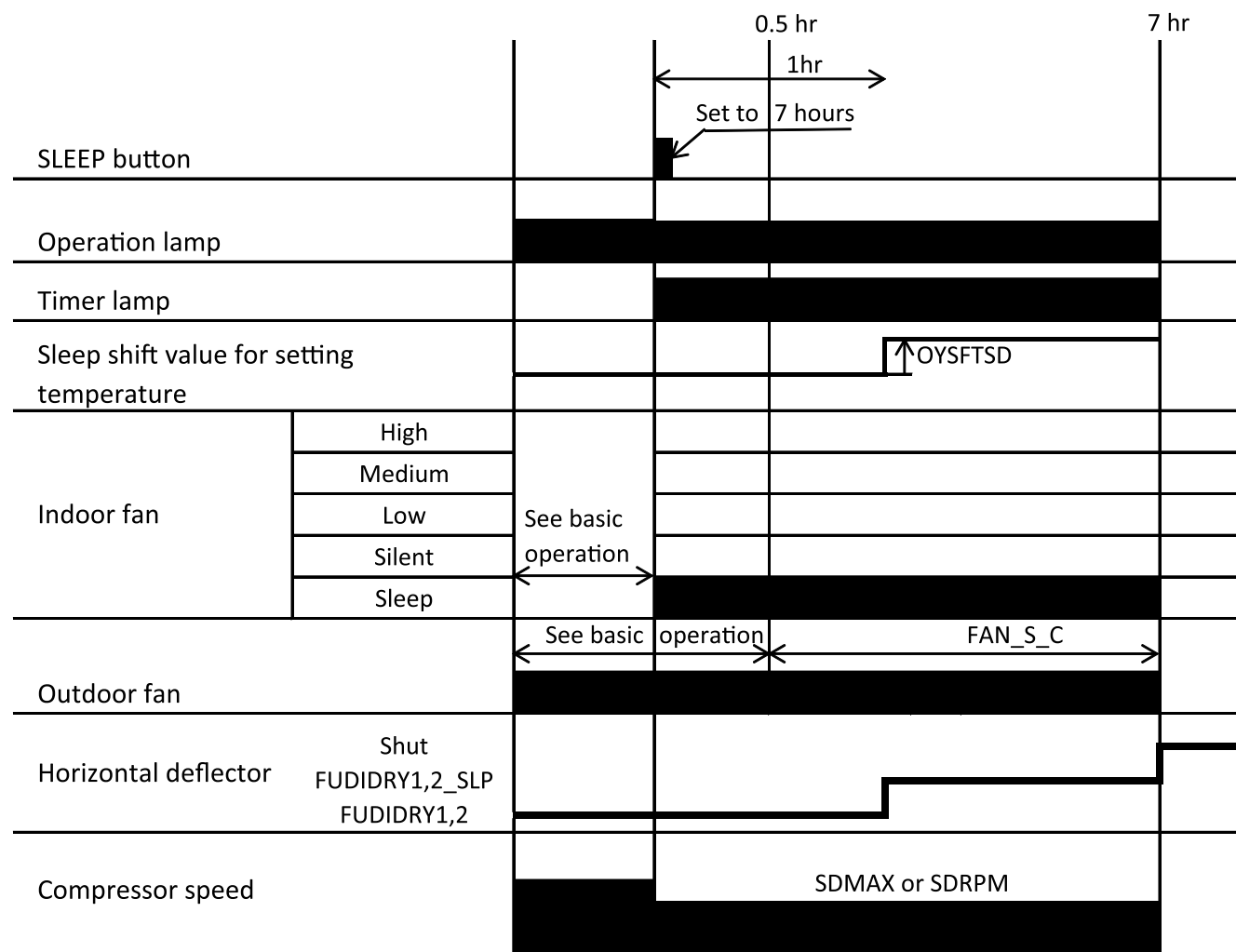

Notes :

- (1) The sleep operation starts when the "SLEEP" button is pressed.
- (2) When the sleep operation is set, the indoor fan set is "sleep"(FDOY_P).
- (3) The indoor fan speed does not change even when the fan speed mode is changed.
- (4) If sleep operation is canceled by the cancel button or sleep button, all data is cleared.
- (5) 1 hour after the sleep operation is set, the sleep shift value(OYSFTSD) is added.

Dehumidifying Powerful Operation

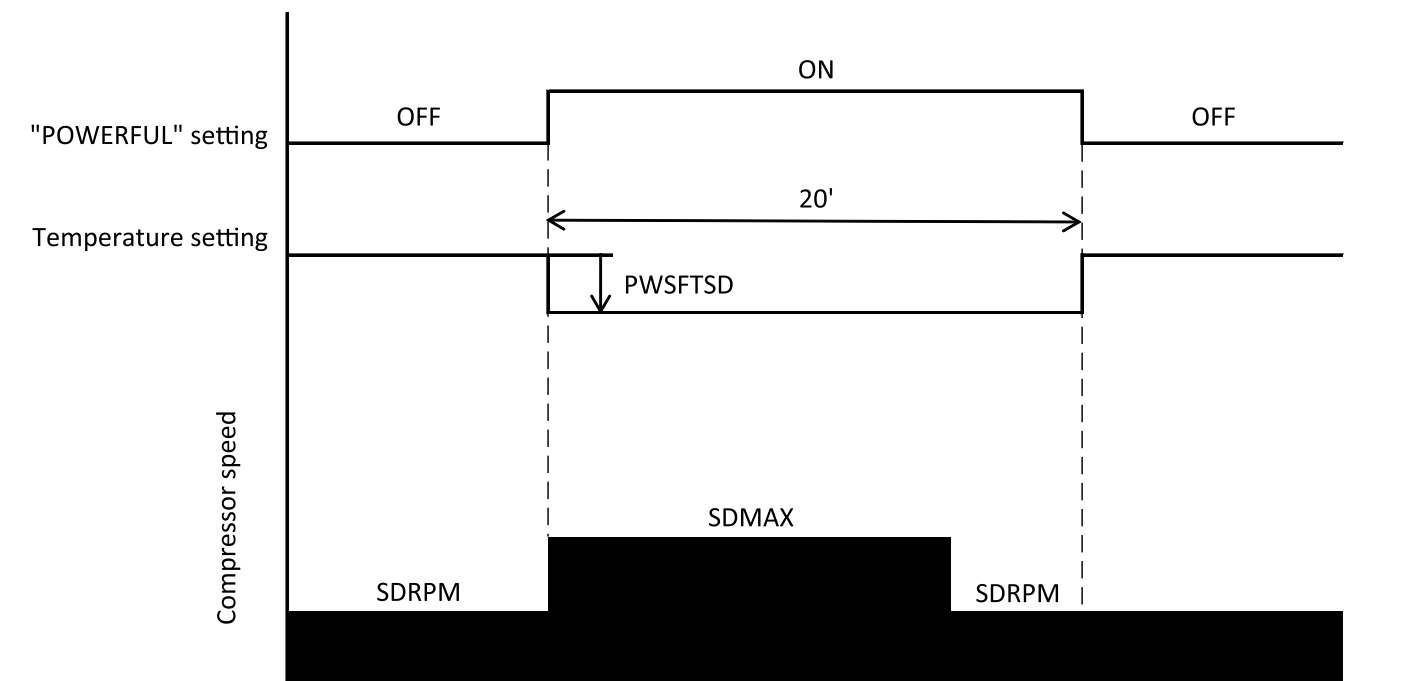

Notes :

- (1) Pressing the "POWERFUL" button will reduce the temperature setting by PWSFTSD.
- (2) The powerful operation is for 20 minutes after setting.
- (3) Operation is continued forcibly thermo-ON for 20 minutes after the powerful operation is finished.
- (4) Pressing the "START/STOP" button and "POWERFUL" button during powerful operation will cancel the powerful operation.
- (5) If the sleep timer is set during powerful operation, the powerful operation will be canceled.
- (6) If the differential (the room temperature - the temperature setting) is "the differential $\geq 3^{\circ}\text{C}$ " after powerful setting, the compressor's maximum speed during powerful operation will be set to SDMAX. Then the differential reduce "the differential $\leq 2.33^{\circ}\text{C}$ " during powerful operation, the compressor's speed will be set to SDRPM. If the differential (the room temperature - the temperature setting) is "the differential $< 3^{\circ}\text{C}$ " after powerful setting, the compressor's minimum speed during powerful operation will be set to SDRPM.
- (7) The fan speed increases by FNUPPW_D.

Basic Heating Operation

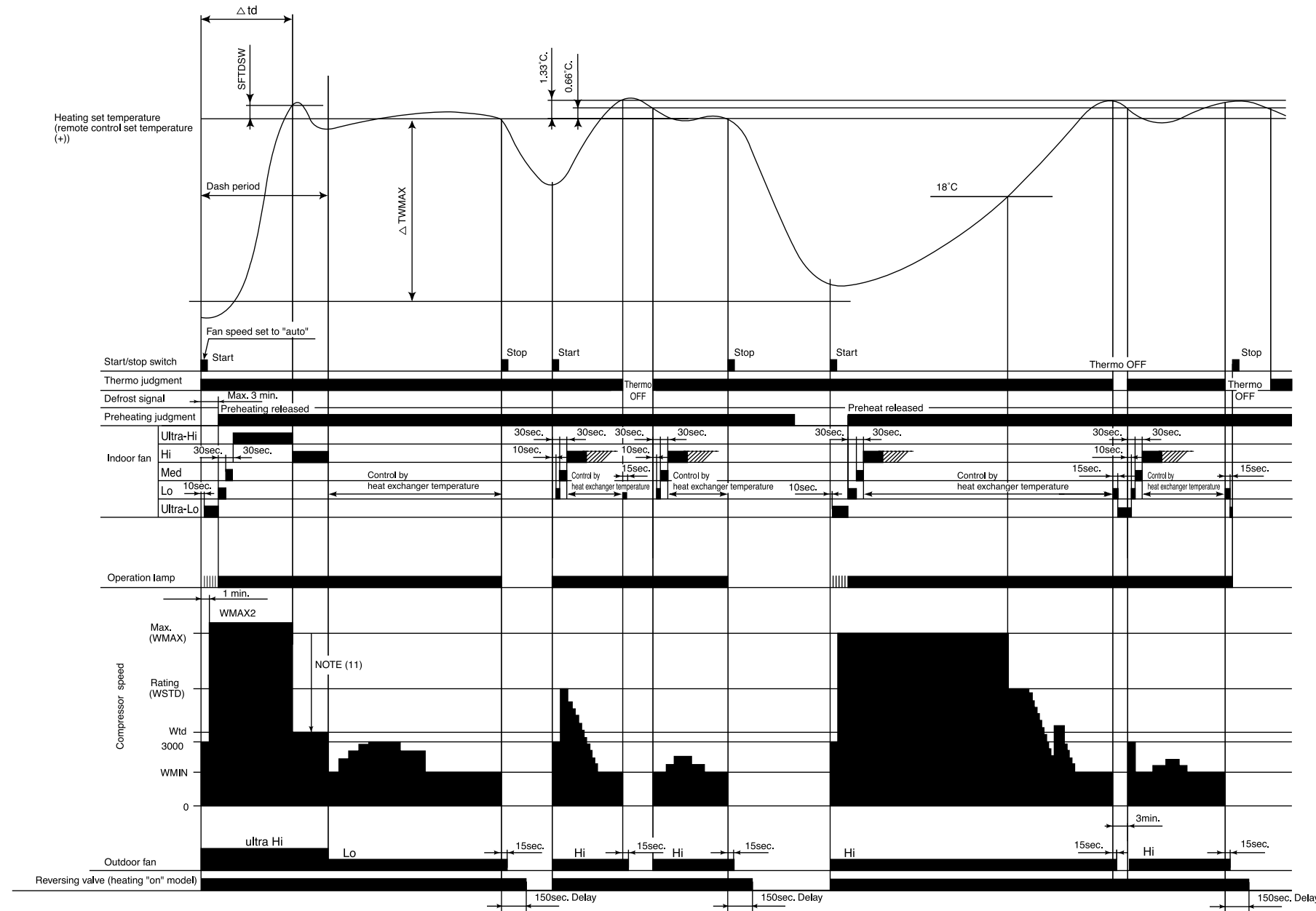

Notes:

- (1) Condition for entering into Hot Dashed mode. When fan set to "Hi" or "Auto mode" and i) Indoor temperature is lower than 18°C, and ii) outdoor temperature is lower than 10°C, and iii) Temperature difference between indoor temperature and set temperature has a corresponding compressor rpm (calculated value in Table 3) larger than WMAX.
- (2) Hot Dashed will release when i) Room temperature has achieved the set temperature + SFTDSW. ii) Thermo off.
- (3) During Hot Dashed operation, thermo off temperature is set temperature (with shift value) +3°C. After thermo off, operation continue in Fuzzy control mode.
- (4) Compressor minimum "ON" time and "OFF" time is 3 minutes.
- (5) During normal heating mode, compressor maximum rpm WMAX will maintain for 120 minutes if indoor temperature is higher than 18°C. No time limit constrain if indoor temperature is lower than 18°C and outdoor temperature is lower than 2°C.
- (6) During Hotkeep or Defrost mode, indoor operation lamp will blink at interval of 3 seconds "ON" and 0.5 second "OFF".
- (7) When heating mode starts, it will enter into Hotkeep mode if indoor heat exchanger temperature is lower than YNEOF + 0.33°C.
- (8) When fan is set to "Med" or "Lo", compressor rpm will be limited to WBEMAX.
- (9) In "Ultra-Lo" fan mode, if indoor temperature is lower than 18°C, indoor fan will stop. If indoor temperature is higher than 18°C + 0.33°C, fan will continue in "Ultra-Lo" mode. During Hotkeep or Defrost mode, fan will continue in "Ultra-Lo" mode.
- (10) During Hot Dashed or outdoor temperature is lower than -5°C, compressor rpm is WMAX2.
- (11) During Hot Dashed, when room temperature reaches set temperature + SFTDSW compressor rpm is actual rpm x DWNRATEW.

Table 3 ΔTWMAX

Temperature difference	Calculated compressor rpm
1.66	1965 min ⁻¹
2	2135 min ⁻¹
2.33	2300 min ⁻¹
2.66	2465 min ⁻¹
3	2635 min ⁻¹
3.33	2800 min ⁻¹
3.66	2965 min ⁻¹
4	3135 min ⁻¹
4.33	3300 min ⁻¹
4.66	3465 min ⁻¹
5	3635 min ⁻¹
5.33	3800 min ⁻¹
5.66	3965 min ⁻¹
6	4135 min ⁻¹
6.33	4300 min ⁻¹
6.66	4465 min ⁻¹
7	4635 min ⁻¹
7.33	4800 min ⁻¹
7.66	4965 min ⁻¹
8	5135 min ⁻¹
8.33	5300 min ⁻¹
8.66	5465 min ⁻¹
9	5635 min ⁻¹
9.33	5800 min ⁻¹
9.66	5965 min ⁻¹
10	6135 min ⁻¹
10.33	6300 min ⁻¹
10.66	6465 min ⁻¹
11	6635 min ⁻¹

Notes:

1. See the data in Table 1 on page 71 for each constant in capital letters in the diagrams.

Reversing Valve Defrosting

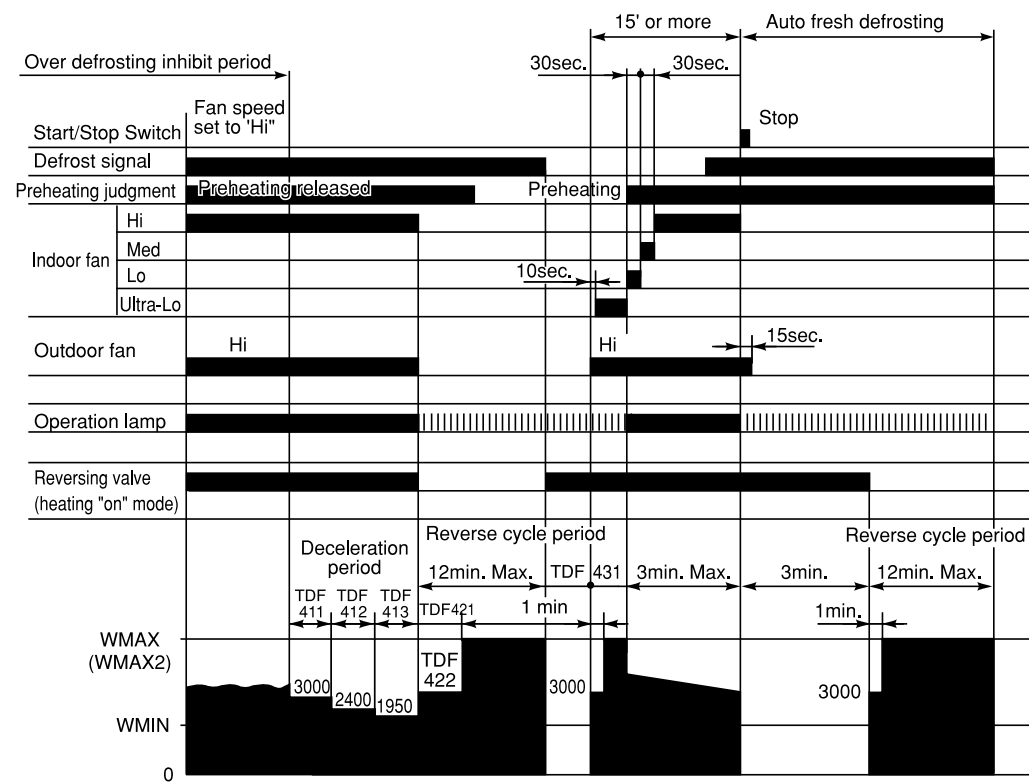

Notes:

- (1) The defrosting inhibit period is set as shown in the diagram below. When defrosting has finished once, the inhibit period is newly set, based on the outdoor temperature when the compressor was started. During this period, the defrost signal is not accepted.
- (2) If the difference between the room and outdoor temperature is large when defrosting is finished, the maximum compressor speed (WMAX) or (WMAX2) can be continued for 120 minutes maximum.
- (3) The defrosting period is 12 minutes maximum.
- (4) When operation is stopped during defrosting, it is switched to auto refresh defrosting.
- (5) Auto refresh defrosting cannot be engaged within 15 minutes after operation is started or defrosting is finished.

Setting Defrosting Inhibit Period

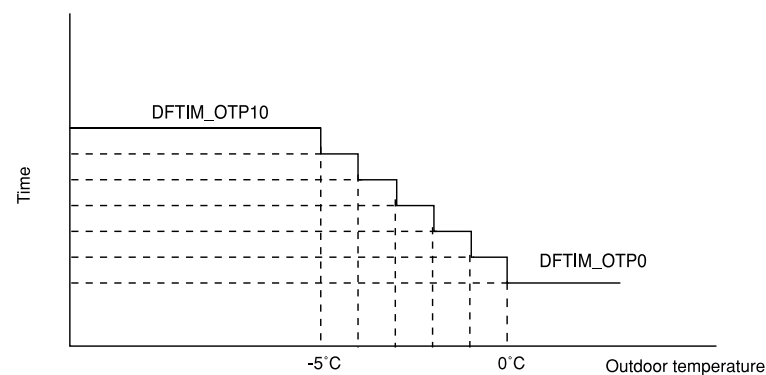

Notes:

- (1) The time is set according to the outdoor temperature when it is between 0°C and -5°C.
- (2) DFTIM_OTP0 is used when the outdoor temperature $\geq 0^\circ\text{C}$.
- (3) DFTIM_OTP10 is used when the outdoor temperature $\leq -5^\circ\text{C}$.

Heating Sleep Operation

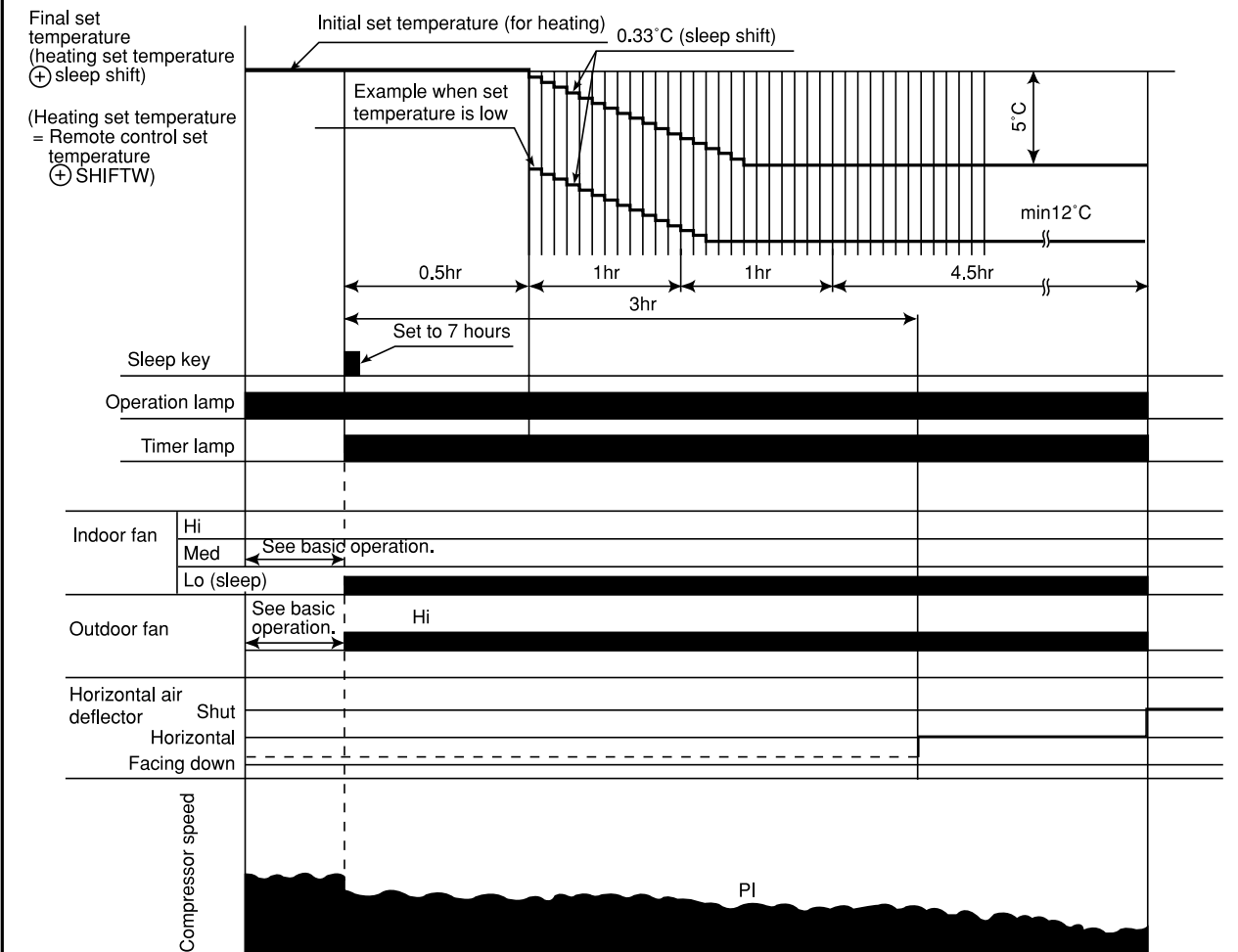

Notes:

- (1) The sleep operation starts when the sleep key is pressed.
- (2) When the sleep key is set, the maximum compressor speed is limited to WSTD+2000/2, and the indoor fan is set to "sleep Lo".
- (3) 30 minutes after the sleep key is set, the sleep shift of set temperature starts.
- (4) The maximum sleep shift of set temperature is 5°C, and the minimum is 12°C.
- (5) If the operation mode is changed during sleep operation, the changed operation mode is set and sleep control starts.
- (6) The indoor fan speed does not change even when the fan speed mode is changed. (Lo)
- (7) When defrosting is to be set during sleep operation, defrosting is engaged and sleep operation is restored after defrosting.
- (8) When operation is stopped during sleep operation, the set temperature when stopped, as well as the time, continue to be counted.
- (9) If the set time is changed during sleep operation, all data including set temperature, time, etc. is cleared and restarted.
- (10) If sleep operation is canceled by the cancel key or sleep key, all data is cleared.

Heating Powerful Operation

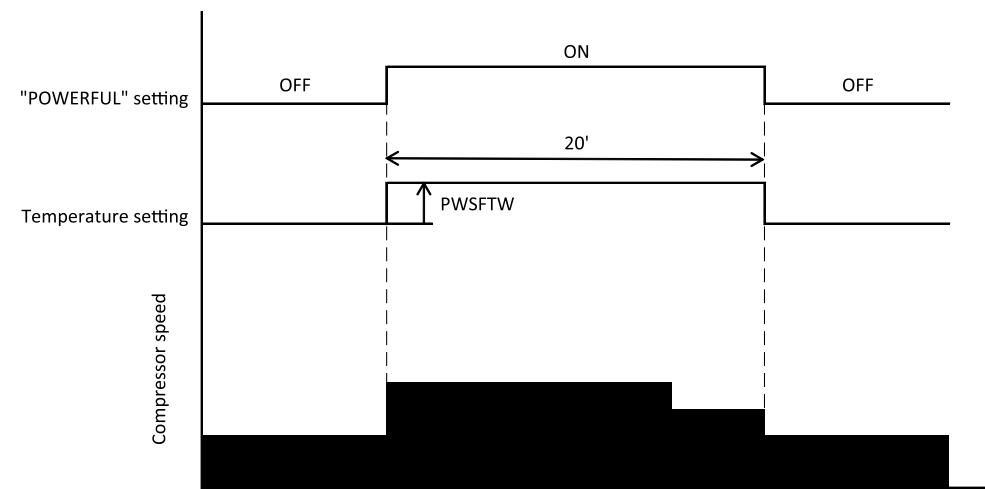

Notes :

- (1) Pressing the "POWERFUL" button will reduce the temperature setting by PWSFTW.
- (2) The powerful operation is for 20 minutes after setting.
- (3) Operation is continued forcibly thermo-ON for 20 minutes after the powerful operation is finished.
- (4) Defrost is inhibited for 20 minutes after the start of the powerful operation.
- (5) Pressing the "START/STOP" button and "POWERFUL" button during powerful operation will cancel the powerful operation.
- (6) If the sleep timer is set during powerful operation, the powerful operation will be canceled.
- (7) If the fan speed of the remote controller is set to "AUTO" or "HIGH", the compressor's maximum speed during powerful operation will be set to WMAX2. The lower limit speed is WKYMIN_PW.
- (8) If the fan speed of the remote controller is set to "MED", the compressor's maximum speed during powerful operation will be set to WJMAX_PW. The lower limit speed is WJKMIN_PW.
- (9) If the fan speed of the remote controller is set to "LOW", the compressor's maximum speed during powerful operation will be set to WBEMAX_PW. The lower limit speed is WBEMIN_PW.
- (10) If the fan speed of the remote controller is set to "SILENT", the compressor's maximum speed during powerful operation will be set to WSZMAX_PW. The lower limit speed is WSZMIN_PW.
- (11) The fan speed increases by FNUPPW_W.

Clean Operation

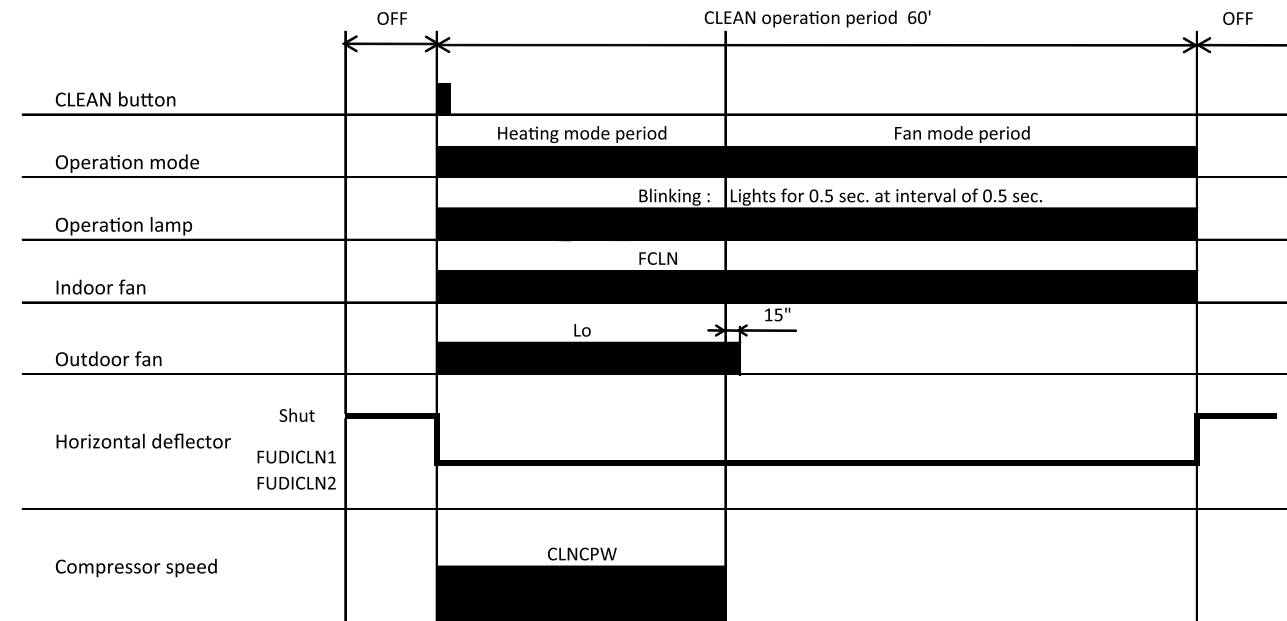

Notes :

- (1) During CLEAN operation period, heating mode will change to fan mode when HEX temperature is "CLNEVP" or more except for 3 minutes operation.
- (2) For multi connections, CLEAN operation is limited to fan mode.

Leave Home

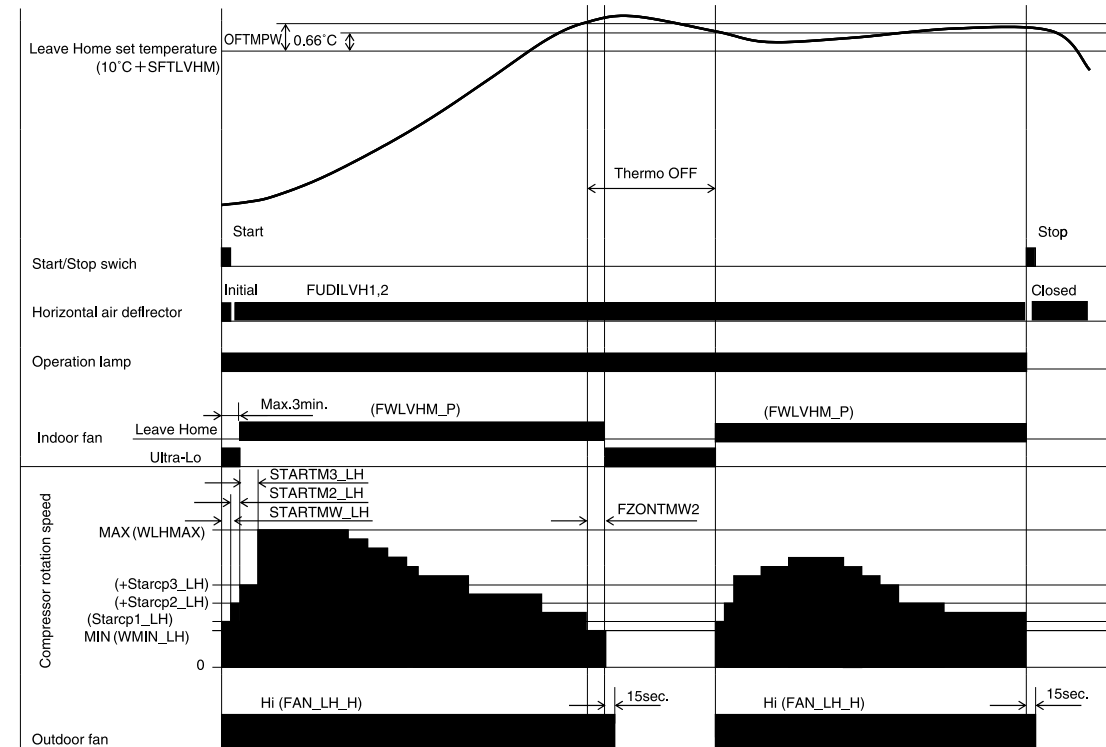

Notes:

Perform Leave Home operation according to the following control contents.

- ① Operation mode : Heating
 - ② Temperature set : 10°C
 - ③ Temperature setting correction shift : + 『SFTLVHM』
 - ④ Indoor fan : 『FWLVHM_P』
 - ⑤ Outdoor fan : 『FAN_LH_H』
 - ⑥ Compressor start control : Set the start control using the special value for the Leave Home mode.
 - ⑦ Compressor rotation speed : Upper limit speed by fuzzy control 『WLHMAX』
Lower limit speed by fuzzy control 『WMIN_LH』
 - ⑧ Operation lamp : The timer lamp lights up when the timer for the desired number of days is set.
- ※ The vertical air deflection plate is initially operated when the Leave Home mode is activated; this serves as a notification that the Leave Home mode has been set.

REFRIGERATING CYCLE DIAGRAM

MODEL RAD-18RPA

RAD-25RPA/RAC-25NPA

RAD-35RPA/RAC-35NPA

COOLING, DEHUMIDIFYING, DEFROSTING

OUTDOOR UNIT

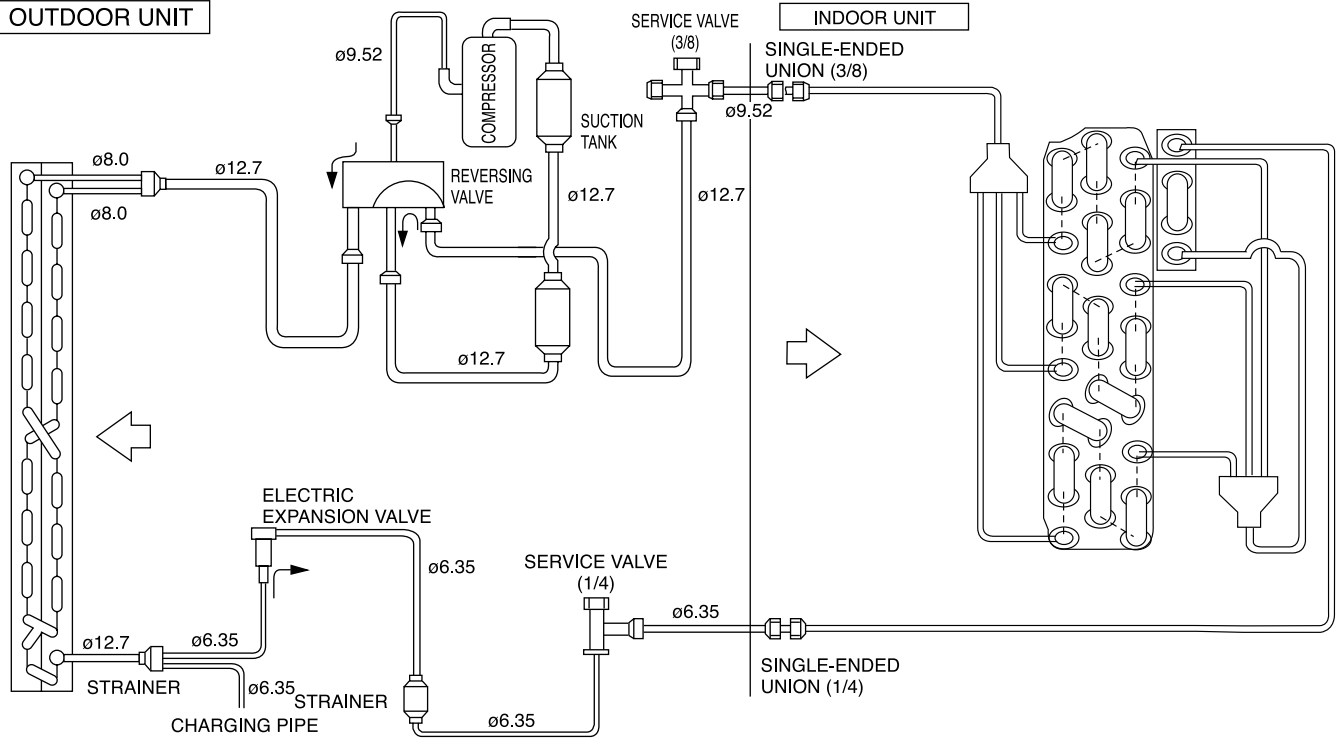

HEATING

OUTDOOR UNIT

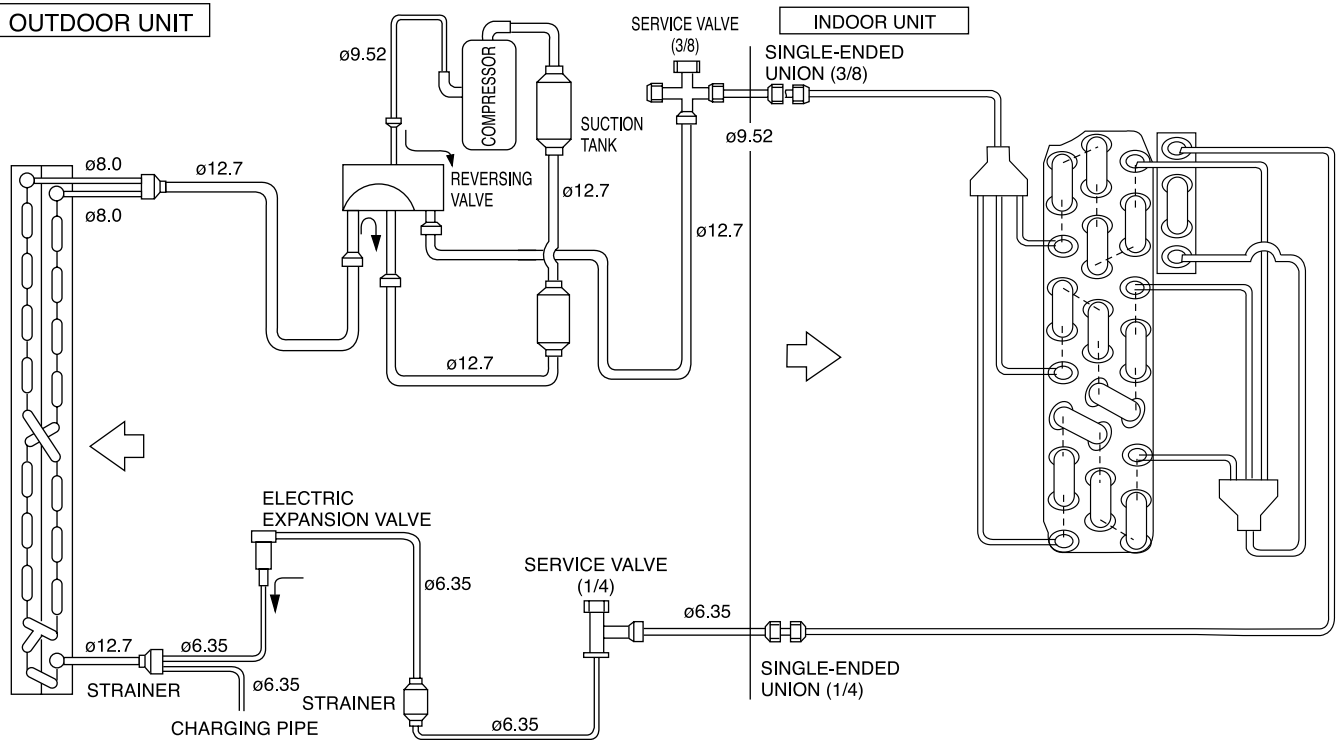

REFRIGERATING CYCLE DIAGRAM

MODEL RAD-50RPA
RAC-50NPA

COOLING, DEHUMIDIFYING, DEFROSTING

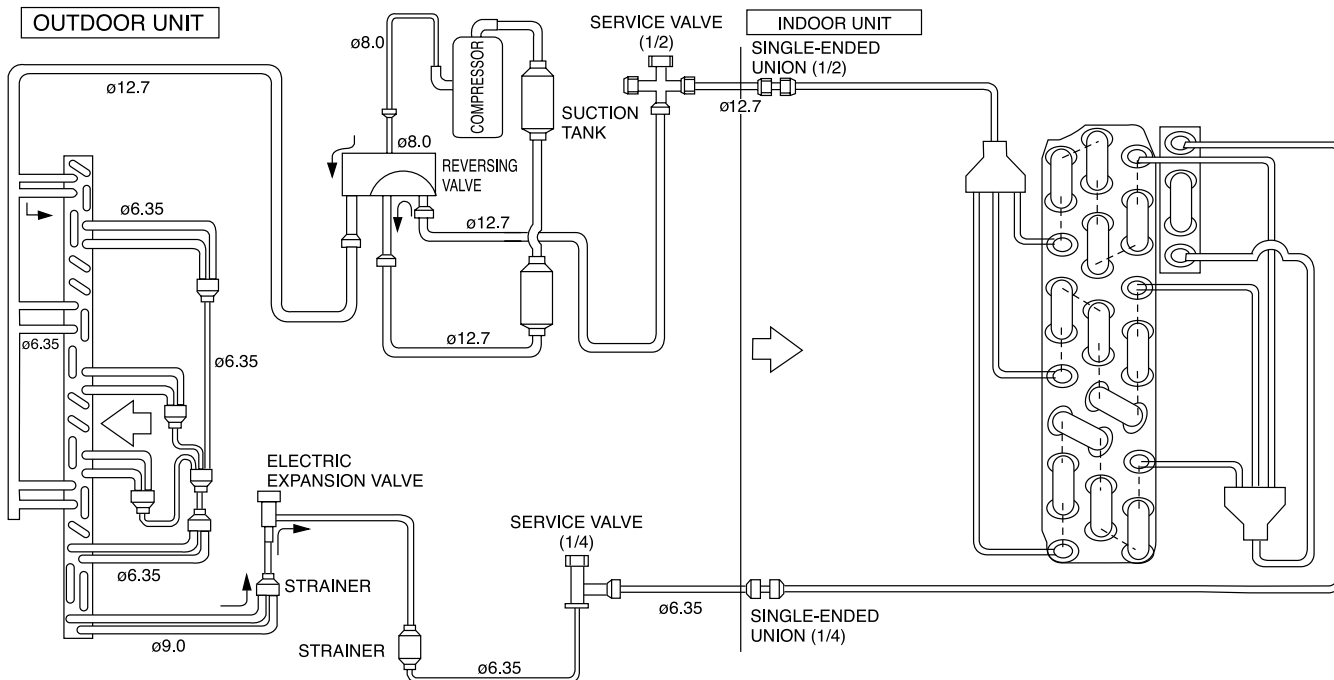

HEATING

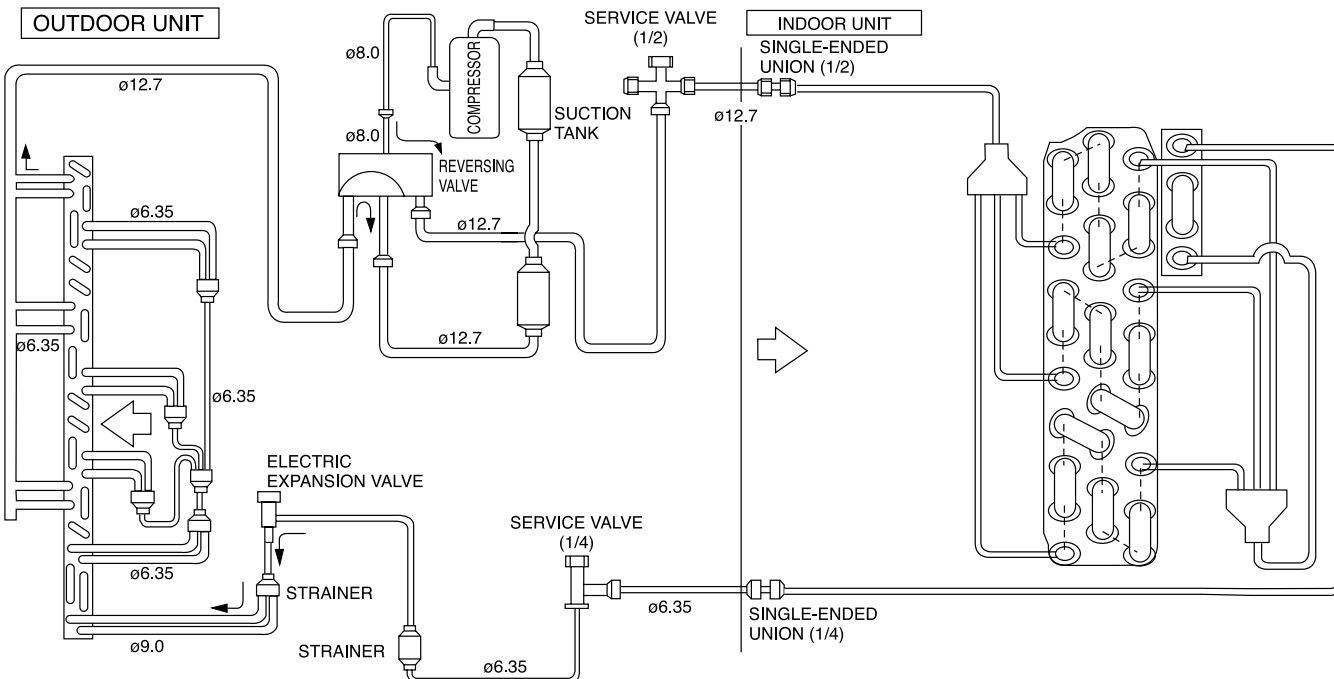

1. Receiver Circuit

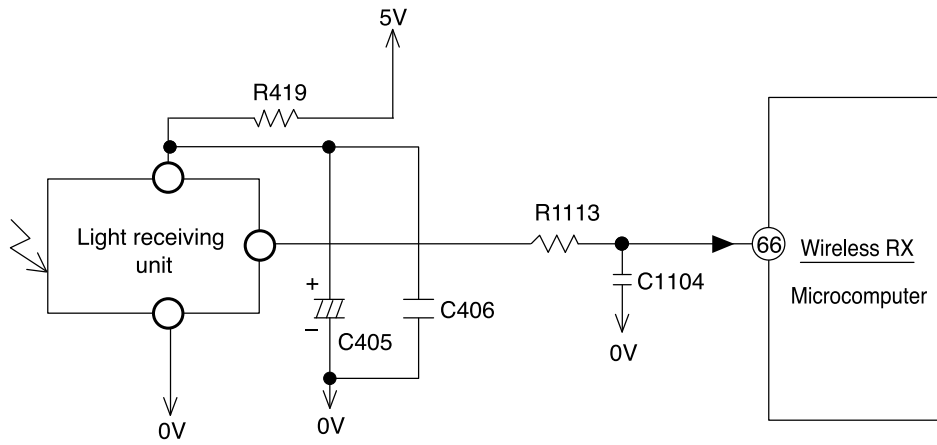

Fig. 1-1

- The light receiver unit receives the infrared signal from the wireless remote control (option part). The receiver amplifies and shapes the signal and outputs it.

2. Buzzer Circuit

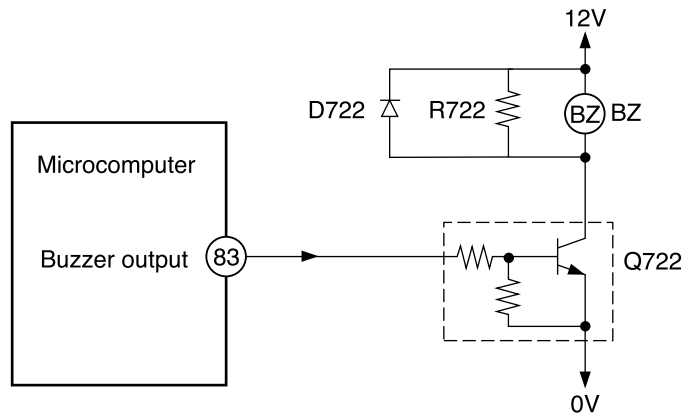

Fig. 2-1 Buzzer Circuit

- When the buzzer sounds, an approx. 3.9kHz square signal is output from buzzer output pin 83 of the microcomputer. After the amplitude of this signal has been set to 12Vp-p by a transistor, it is applied to the buzzer. The piezoelectric element in the buzzer oscillates to generate the buzzer's sound.

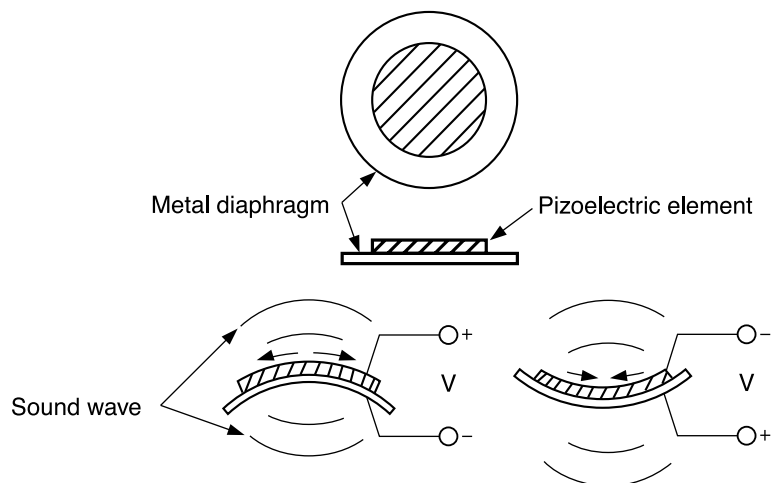
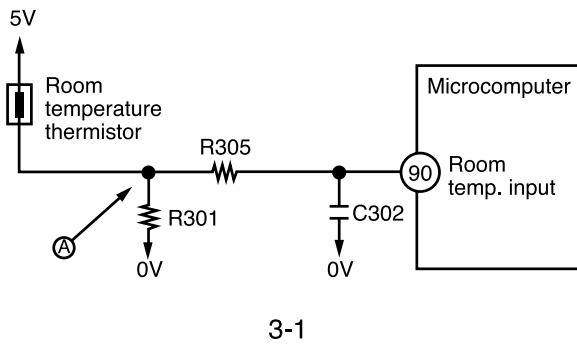

Fig. 2-2 Buzzer Operation

3. Room Temperature Thermistor Circuit

- Fig. 3-1 shows the room temperature thermistor circuit.



- The voltage at (A) depends on the room temperature as shown in Fig. 4-2.

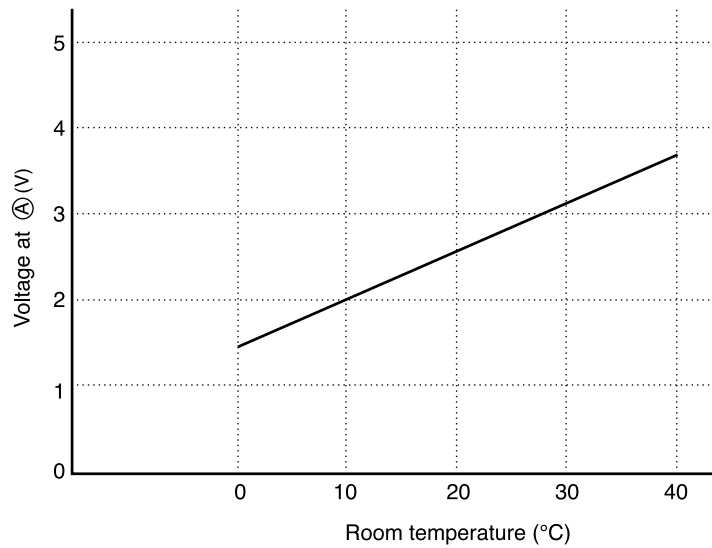
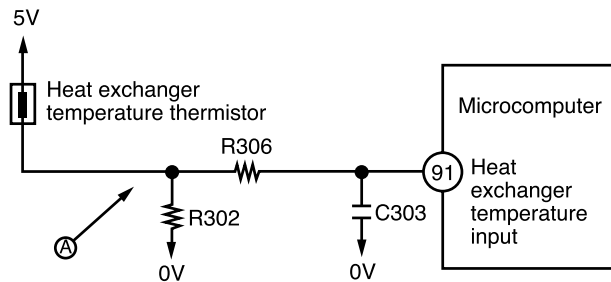

Fig. 3-2

4. Heat exchanger temperature thermistor circuit



- The circuit detects the indoor heat exchanger temperature and controls the following.

- (1) Preheating.
- (2) Low-temperature defrosting during cooling and dehumidifying operation.
- (3) Detection of the reversing valve non-operation or heat exchanger temperature thermistor open.

The voltage at (A) depends on the heat exchanger temperature as shown in Fig. 4-2.

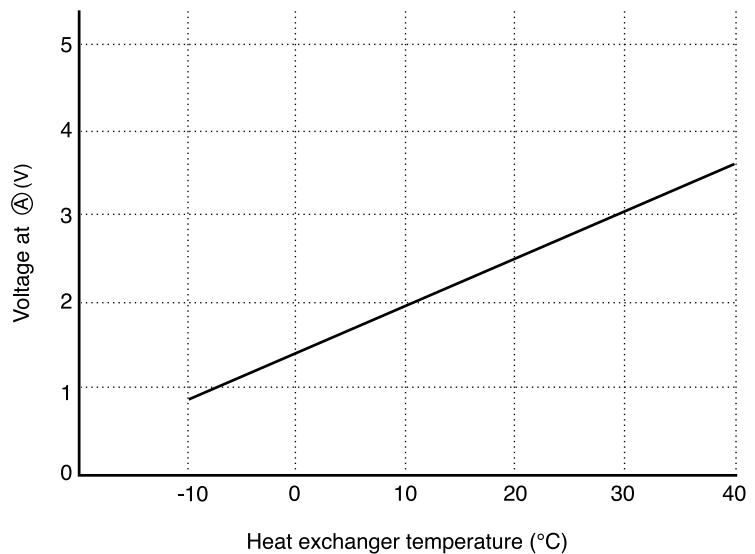

Fig. 4-2

5. Initial Setting Circuit (IC401)

- When power is supplied, the microcomputer reads the data in IC401 (E²PROM) and sets the preheating activation value and the rating and maximum speed of the compressor, etc. to their initial values.
- Data of self-diagnosis mode is stored in IC401; data will not be erased even when power is turned off.

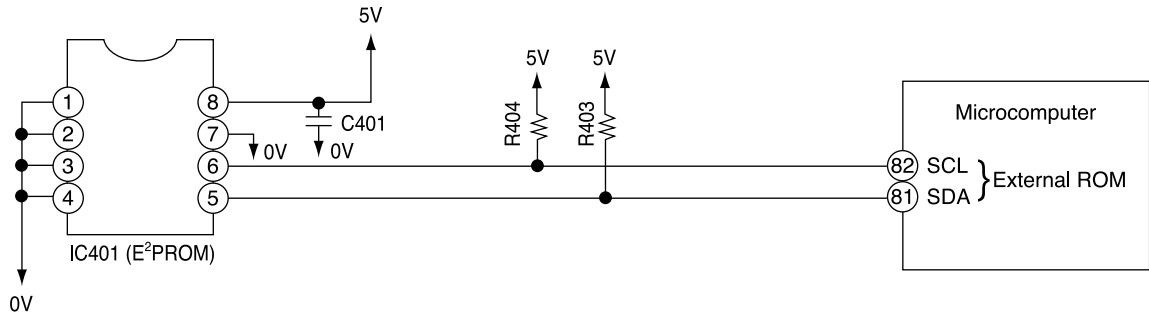

Fig. 5-1

6. Temporary Switch

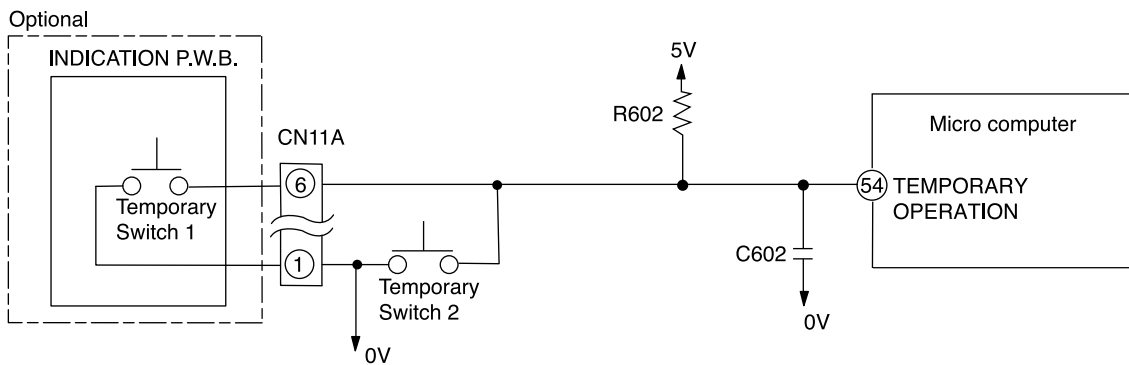

Fig. 6-1

- The temporary switch is used to operate the air conditioner temporarily when the wireless remote control is lost or faulty.

7. Drain pump drive circuit

When cool or dehumidifying operation, pin ⑧4 of the micro computer goes “Hi”, Q933 and Q932 turn on and the drain pump drive.

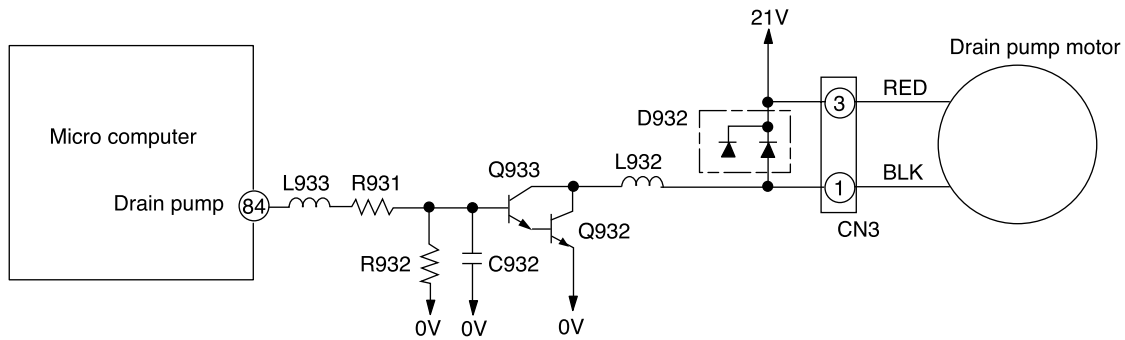

Fig. 7-1

8. Drain pump trial run switch

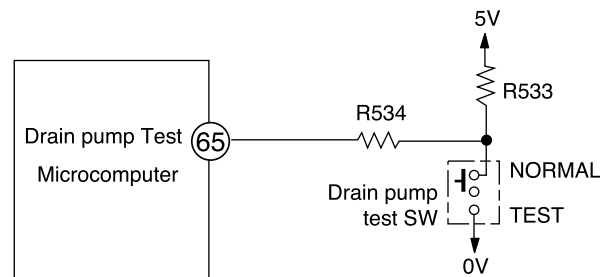

Fig. 8-1

- This switch forcibly turns the drain pump on. When the drain pump trial run switch is turned to test, the timer indicator will blink seven times, and no remote signal will be accepted.

9. Float switch

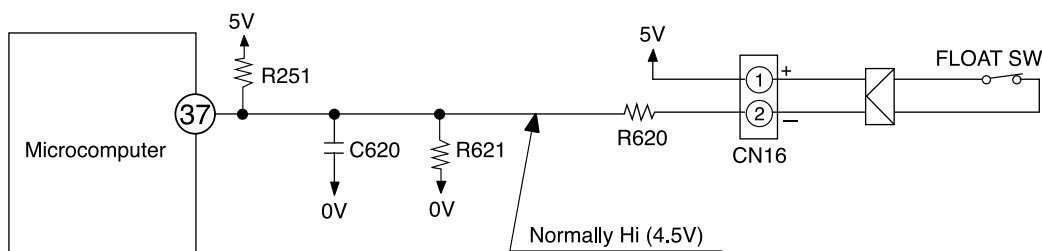

Fig. 9-1

- This is a float type switch that monitors the drain level of drain pan. The switch will be activated and will stop operation if the drain pump is faulty or drain hose is stopped up, disabling drainage, causing the drain level to rise abnormally.
- When the float switch is activated, the timer indicator will flash six times. Note that the float switch will also be activated, disabling operation if the connector of float switch has defective contact or is connected incompletely.

10. High static-pressure switch (Full duct type and semi duct type)

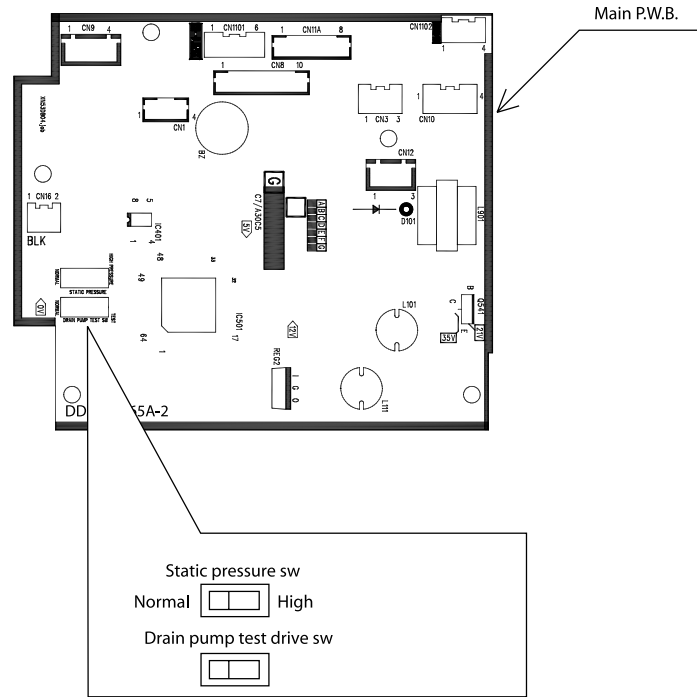
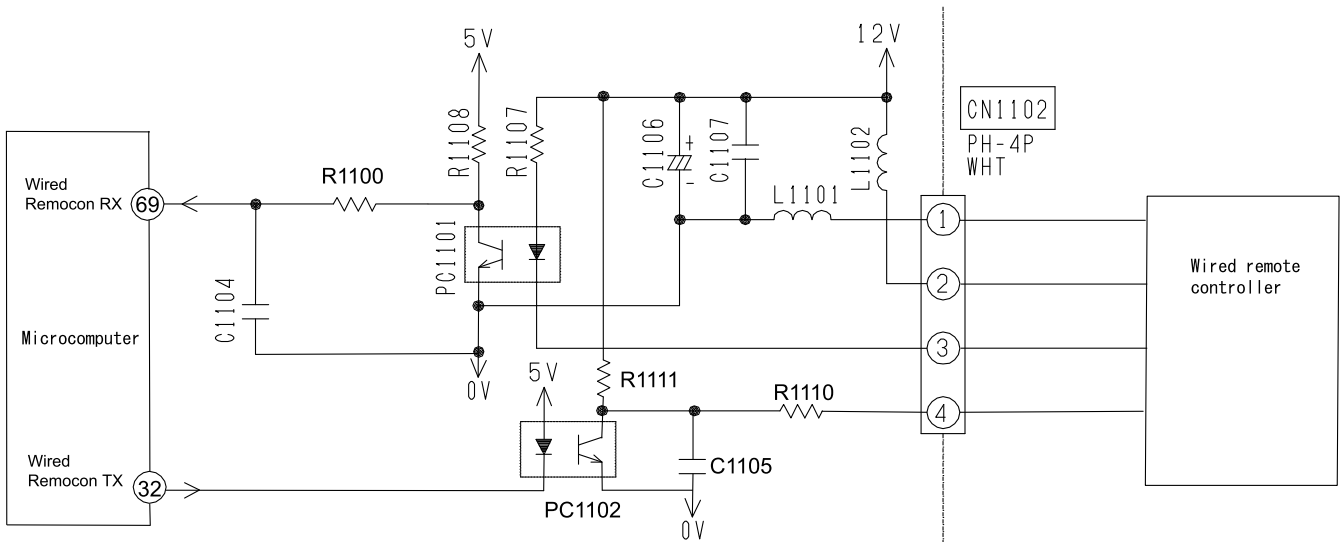

Fig. 10-1

- For full duct type and semi duct type, set the high to HIGH STATIC-PRESSURE.
- If not set to HIGH, there will be reduction of cooling and heating capacities.

11. Wired remote control receive and transmit circuit.



- In wired remote control circuit, the signal will transmit to micro computer pin 69 by using photocoupler PC1101 and receive from micro computer pin 32 by using photocoupler PC1102.

Model RAC-25NPA, RAC-35NPA, RAC-50NPA

1. Power Circuit

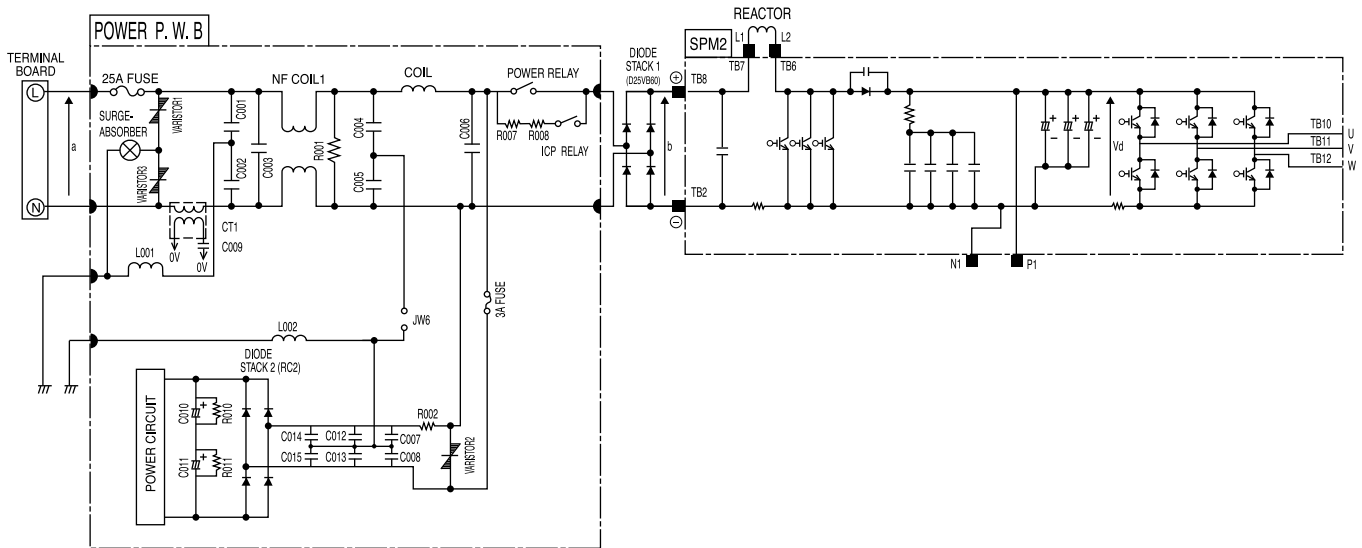

Fig. 1-1

- This circuit full-wave rectifies 220-240V AC applied between terminals L and N, and boosts it to a required voltage with the active module, to create a DC voltage.

The voltage becomes 260-360V when the compressor is operated

(1) Active module

The active filter, consisting of a reactor and switching element, eliminates higher harmonic components contained in the current generated when the compressor is operated, and improves the power-factor.

(2) Diode stacks

These rectify the 220-240V AC from terminals L and N to a DC power supply.

< Reference >

- In case of malfunction or defective connection: Immediately after the compressor starts, it may stop due to “abnormally low speed” active error, etc.

The compressor may continue to operate normally, but the power-factor will decrease, the operation current will increase, and the overcurrent breaker of the household power board will probably activate.

- In case of active module faulty or defective connection:

Although the compressor continues to operate normally, the power-factor will decrease, the operation current will increase, and the overcurrent breaker of the household power board will probably activate.

< Reference >

- If diode stack 1 is faulty, the compressor may stop due to “lp”, “abnormally low speed”, etc. immediately after it starts, or it may not operate at all because no DC voltage is generated between the positive ⊕ and negative ⊖ terminals.

If diode stack 1 is faulty, be aware that the 25A fuse might also have blown.

- If diode stack 2 is faulty, DC voltage may not be generated and the compressor may not operate at all. Also, be aware that the 3A fuse might have blown.

(3) Smoothing capacitor (C501, C502, C503)

This smoothes (averages) the voltage rectified by the diode stacks.

<Notes> Smoothing capacitor C501 is not available for model RAC-25NPA and RAC-35NPA.

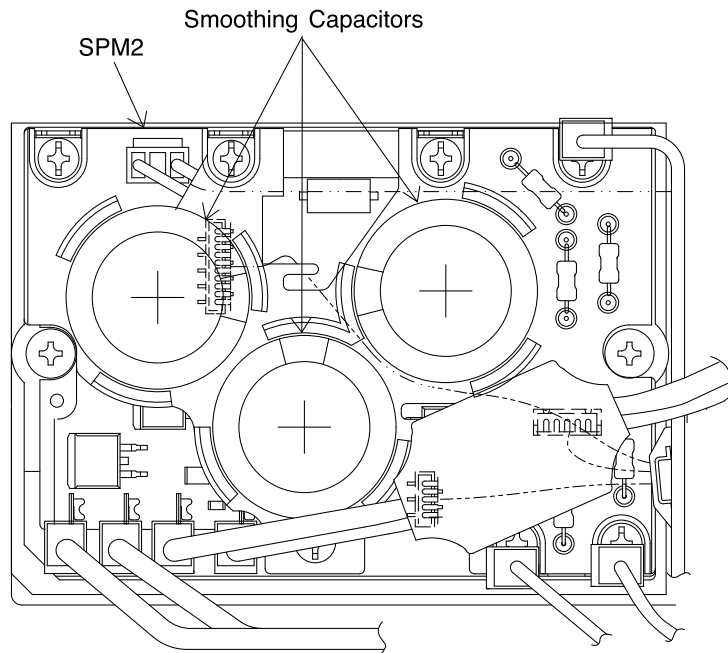

Fig. 1-2

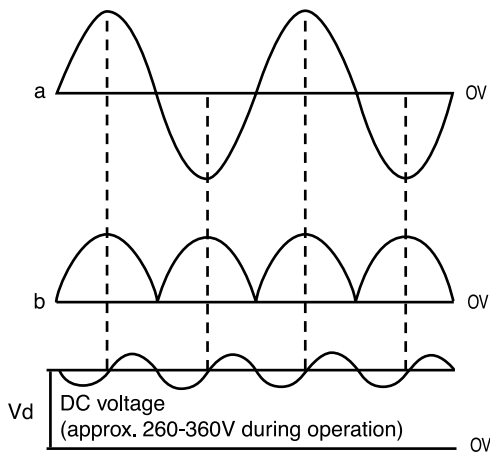

Fig. 1-3

- Be careful to avoid an electric shock as a high voltage is generated. Also take care not to cause a short-circuit through incorrect connection of test equipment terminals. The circuit board could be damaged.

(4) Smoothing capacitor (C010, C011)

This smoothes (averages) the voltage rectified by the diode stack2. A DC voltage is generated in the same way as in Fig. 1-3.

Voltage between + side of C010 and – side of C011 is about 330V.

(5) C001 to C003, C012 to C015, C007, C008, NF COIL1, COIL, absorb electrical noise generated during operation of compressor, and also absorb external noise entering from power line to protect electronic parts.

(6) Surge absorber, Varistor 1, 2, 3, absorbs external power surge.

(7) Inrush protective resistor (R007, R008)

This works to protect from overcurrent when power is turned on.

< Reference >

- When inrush protective resistor is defective, diode stack may malfunction. As a result, DC voltage is not generated and no operation can be done.

2. Indoor/Outdoor Interface Circuit

- The interface circuit superimposes an interface signal on the DC 35V line supplied from the outdoor unit to perform communications between indoor and outdoor units. This circuit consists of a transmitting circuit which superimposes an interface signal transmit from the microcomputer on the DC 35V line and a transmitting circuit which detects the interface signal on the DC 35V line and outputs it to the microcomputer.
- Communications are performed by mutually transmitting and receiving the 4-frame outdoor request signal one frame of which consists of a leader of approx. 100 ms., start bit, 8-bit data and stop bit and the command signal with the same format transmit from the indoor unit.
- Communication signal from outdoor microcomputer to indoor microcomputer. At first outdoor microcomputer will send a request signal (SDO) to indoor microcomputer. A high-frequency IF signal approx. 38 KHz is generated and modulated by the request signal (SDO) inside the outdoor microcomputer then output to pin (11) of microcomputer. This modulated IF signal is output to pin (30) of HIC and amplified by amp. This signal is superimposed to DC 35V line via C801 and L801.
To prevent erroneous reception, the outdoor microcomputer is designed so that it cannot receive a signal while it is outputting a request signal.
The receiving circuit in the indoor unit consists of a comparator and transistor. The interface signal from the outdoor unit on the DC 35V line is supplied to C821, where DC components are eliminated, and is then shaped by the comparator. The shaped signal is detected by diode, amplified by amp, and output to pin (49) of the indoor microcomputer.
Fig. 2-2 shows the voltages at each component when data is transferred from the outdoor microcomputer to the indoor microcomputer.
- Communication signal from indoor microcomputer to outdoor microcomputer. The request signal (SDO) generates by indoor microcomputer is output to pin (50), and amplifies by C801. IF signal approx. 38 kHz is generated by comparator, then modulate by the request signal from pin (50) of indoor microprocessor. This modulated IF signal is then amplified and superimposed to DC 35V line via L801 and C802 of indoor interface circuit.
Fig. 2-3 shows the voltages at each component when data is transferred from outdoor microcomputer to indoor microcomputer.
The circuit operation of the outdoor receiving circuit is same as indoor receiving circuit.

- Fig. 2-1 shows the interface circuit used for the indoor and outdoor microcomputers to communicate with each other.

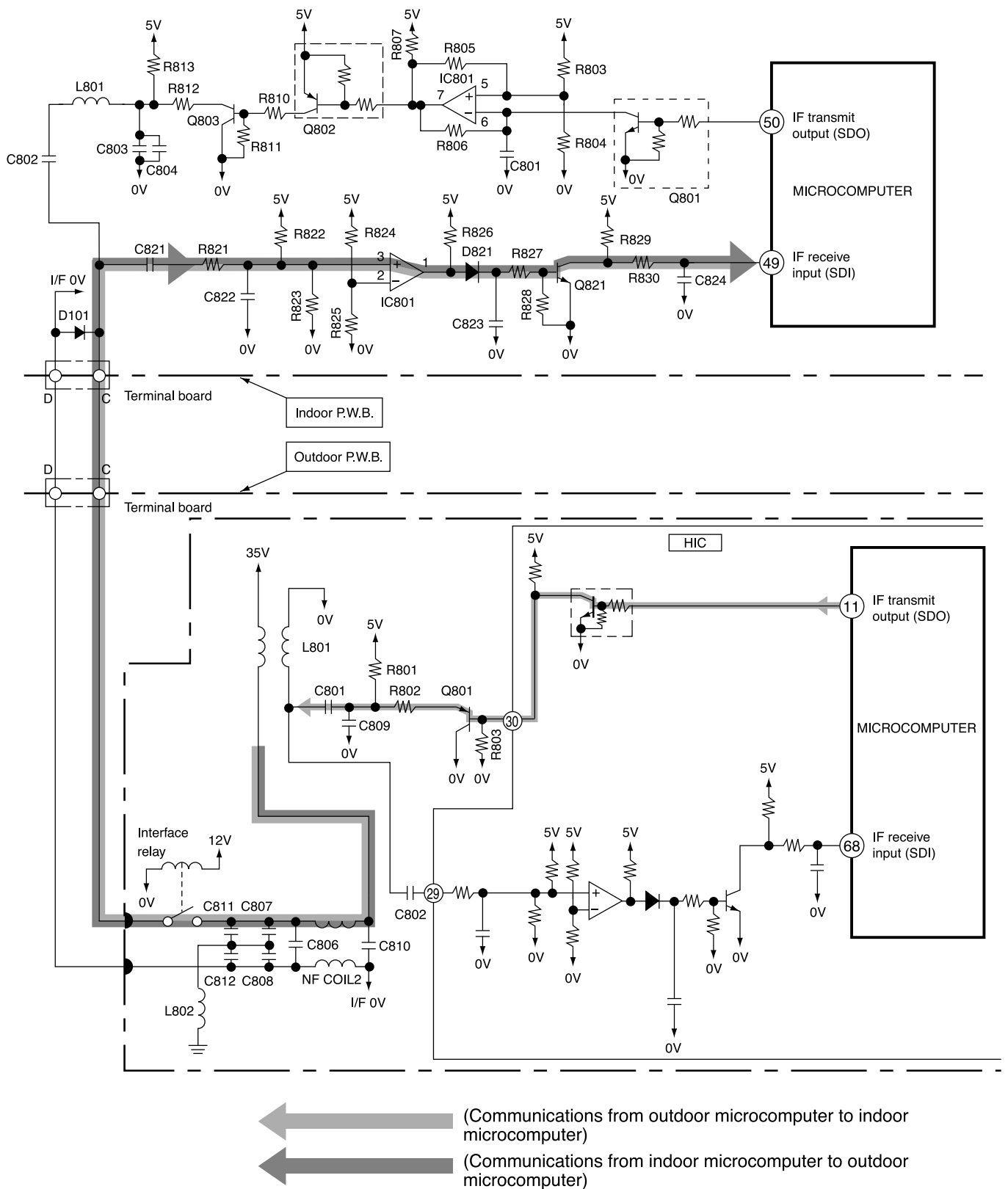

Fig. 2-1 Indoor/outdoor interface Circuit

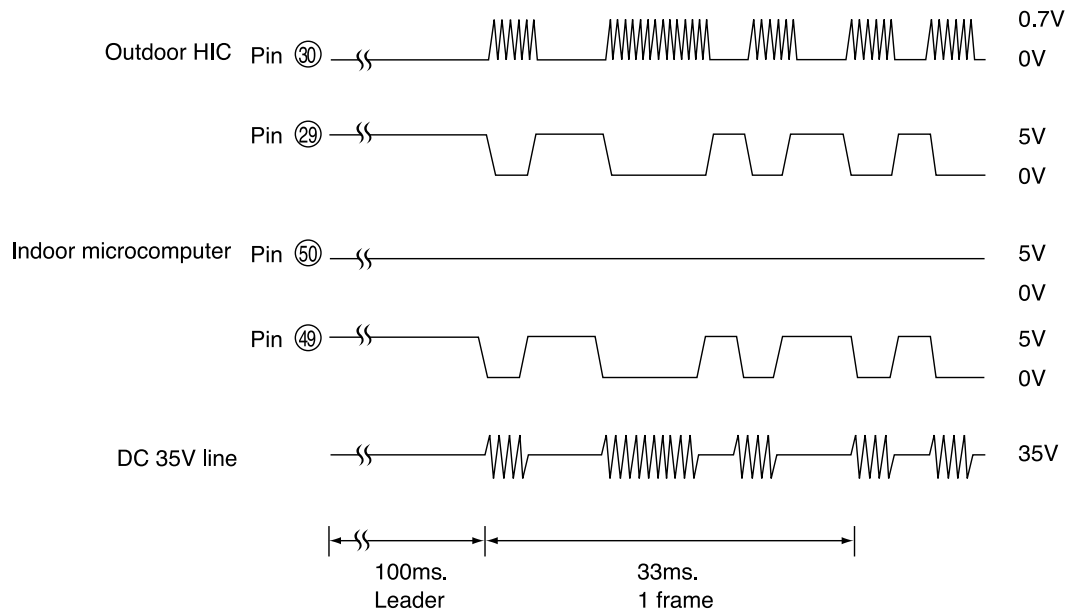

Fig. 2-2 Voltages Waveforms of indoor / Outdoor Microcomputers (Outdoor to Indoor Communications)

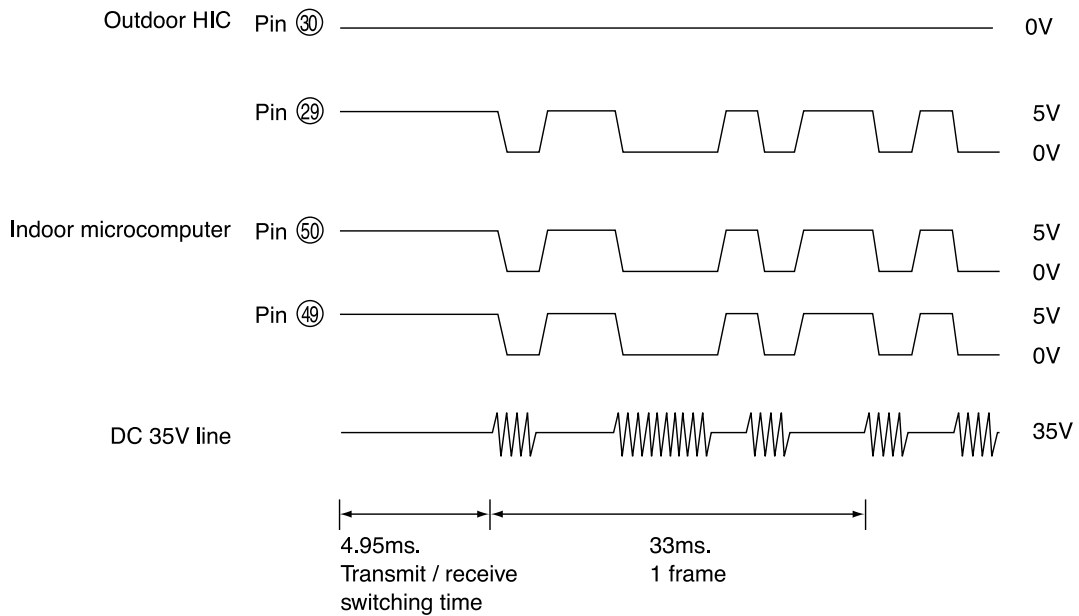
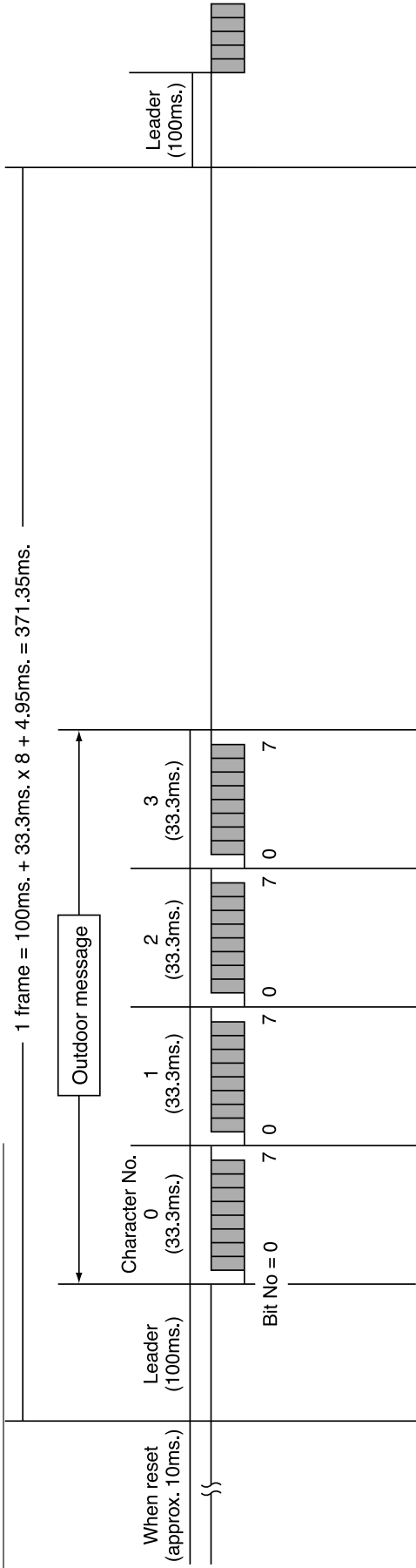

Fig. 2-3 Voltages Waveforms of indoor / Outdoor Microcomputers (Indoor to Outdoor Communications)

[Serial Communications Format during Normal Communications]

(1) Outdoor microcomputer (HIC) to indoor microcomputer



(2) Indoor microcomputer to outdoor microcomputer (HIC)

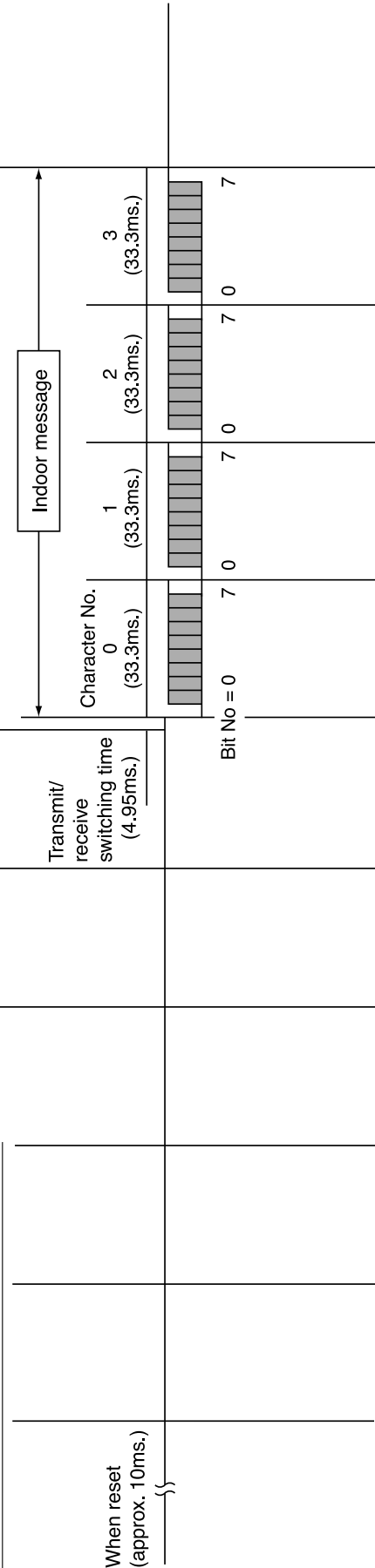

(3) Communications waveforms

[Example] When the outdoor message is all 0s and indoor message is all 1s:

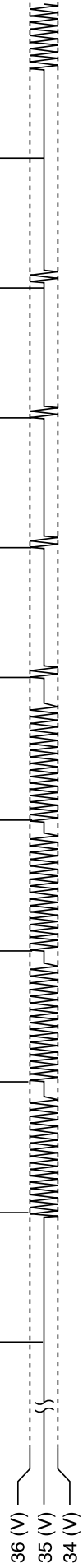

Fig. 2-4

[Serial Communications Data]

(1) Outdoor message

Character No.	0								1								2								3																							
Bit No.	7	6	5	4	3	2	1	0	7	6	5	4	3	2	1	0	7	6	5	4	3	2	1	0	7	6	5	4	3	2	1	0																
Contents	Multi-bit								During forced operation								Outside temperature (0 LSB)	Outside temperature (1)	Outside temperature (2)	Outside temperature (3)	Outside temperature (4)	Outside temperature (5)	Outside temperature (6)	Outside temperature (7 MSB)	Compressor during operation	Compressor during operation	Actual compressor rotation speed (0 LSB)	Actual compressor rotation speed (1)	Actual compressor rotation speed (2)	Actual compressor rotation speed (3)	Actual compressor rotation speed (4)	Actual compressor rotation speed (5 MSB)	Fan-7-step request															
Data	1/0	0							1/0	1/0	1/0	1/0	1/0	1/0	1/0	1/0	1/0	1/0	1/0	1/0	1/0	1/0	1/0	1/0	1/0	1/0	1/0	1/0	1/0	1/0	1/0	1/0	1	0	0	0	0	0	0	0	0	0	0	0	0	0	0	0

(2) Indoor message

Character No.	0								1								2								3															
Bit No.	7	6	5	4	3	2	1	0	7	6	5	4	3	2	1	0	7	6	5	4	3	2	1	0	7	6	5	4	3	2	1	0								
Contents	Operation mode (0 LSB)	Operation mode (1)	Operation mode (2 MSB)	Indoor in-operation bit	Capacity code (0 LSB)	Capacity code (1)	Capacity code (2)	Capacity code (3 MSB)	Fan (0 LSB)	Fan (1)	Fan (2 MSB)	2-way valve	Reversing valve			Compressor ON	Compressor command speed (0 LSB)	Compressor command speed (1)	Compressor command speed (2)	Compressor command speed (3)	Compressor command speed (4)	Compressor command speed (5)	Compressor command speed (6)	Compressor command speed (7 MSB)	15/20(A)	OVL up	Compressor minimum rotation speed (0 LSB)	Compressor minimum rotation speed (1)	Compressor minimum rotation speed (2)	Compressor minimum rotation speed (3)	Compressor minimum rotation speed (4 MSB)									
Data	1/0	1/0	1/0	1/0	0	0	0	0	1/0	1/0	1/0	0	1/0	0	0	1/0	1/0	1/0	1/0	1/0	1/0	1/0	1/0	1/0	1/0	1/0	1/0	1/0	1/0	1/0	1/0	1/0								

3. Power Module Circuit

- Fig. 3-1 shows the system power module and its peripheral circuit.
The three transistors on the positive ⊕ side are called the upper arm, and the three transistors on the negative ⊖ side are called the lower arm.

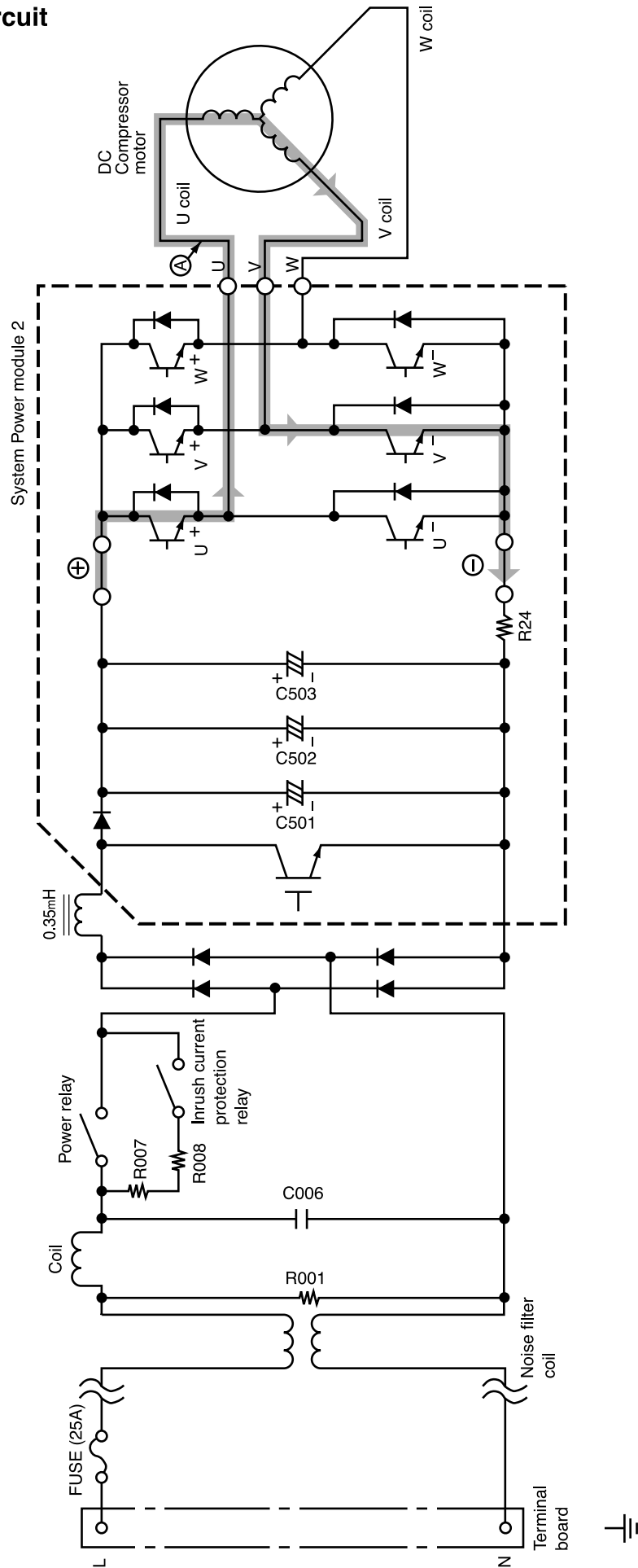

Fig. 3-1 Power module circuit (U⁺ is ON, V⁻ is ON)

- DC 260-360V is input to system power module and system power module switches power supply current according to rotation position of magnet rotor. The switching order is as shown in Fig. 3-2.

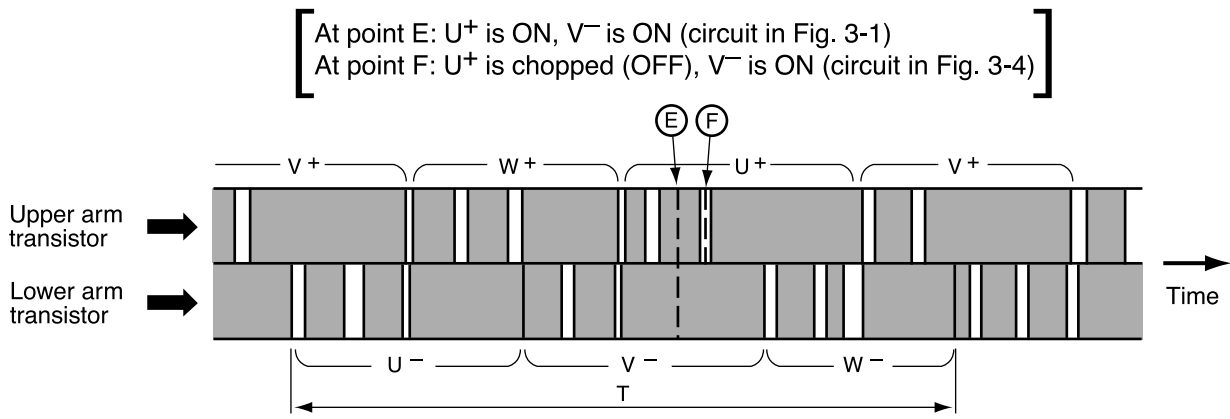

Fig. 3-2 Switching order of power module

- Upper arm transistor is controlled to ON/OFF by 3.3kHz chopper signal. Rotation speed of the compress is proportional to duty ratio (ON time/ ON time + OFF time) of this chopper signal.
- Time T in Fig. 3-2 shows the switching period, and relation with rotation speed (N) of the compressor is shown by formula below;

$$N = 60/2 \times 1/T$$

- Fig. 3-3 shows voltage waveform at each point shown in Figs. 3-1 and 3-4. First half of upper arm is chopper, second half is ON, and first half of lower arm is chopper, second half is ON.

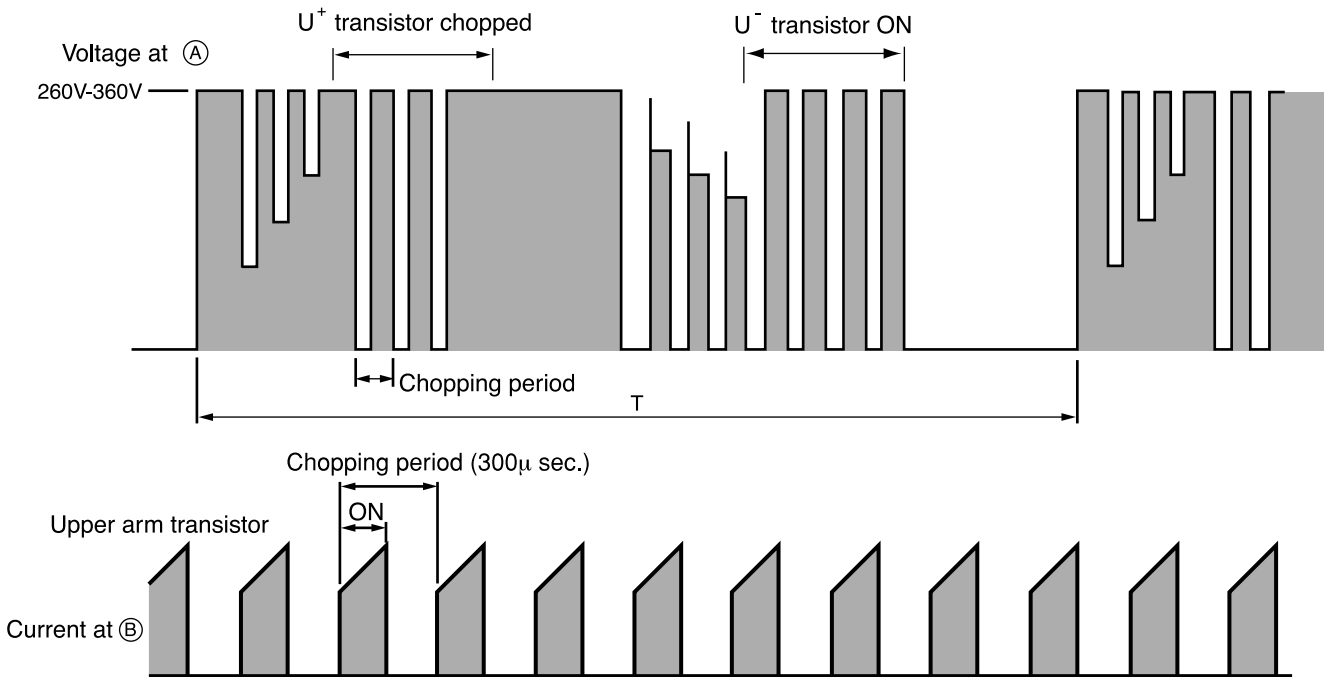

Fig. 3-3 Voltage waveform at each point

- When power is supplied U⁺ → U⁻, because of that U⁺ is chopped, current flows as shown below; (B)
 - (1) When U⁺ transistor is ON: U⁺ transistor → U coil → V coil → V⁻ transistor → DC current detection resistor → Point (B) (Fig. 3-1)
 - (2) When U⁺ transistor is OFF: (by inductance of motor coil) U coil → V coil → V⁻ transistor → Return diode → Point (A) (Fig. 3-4)

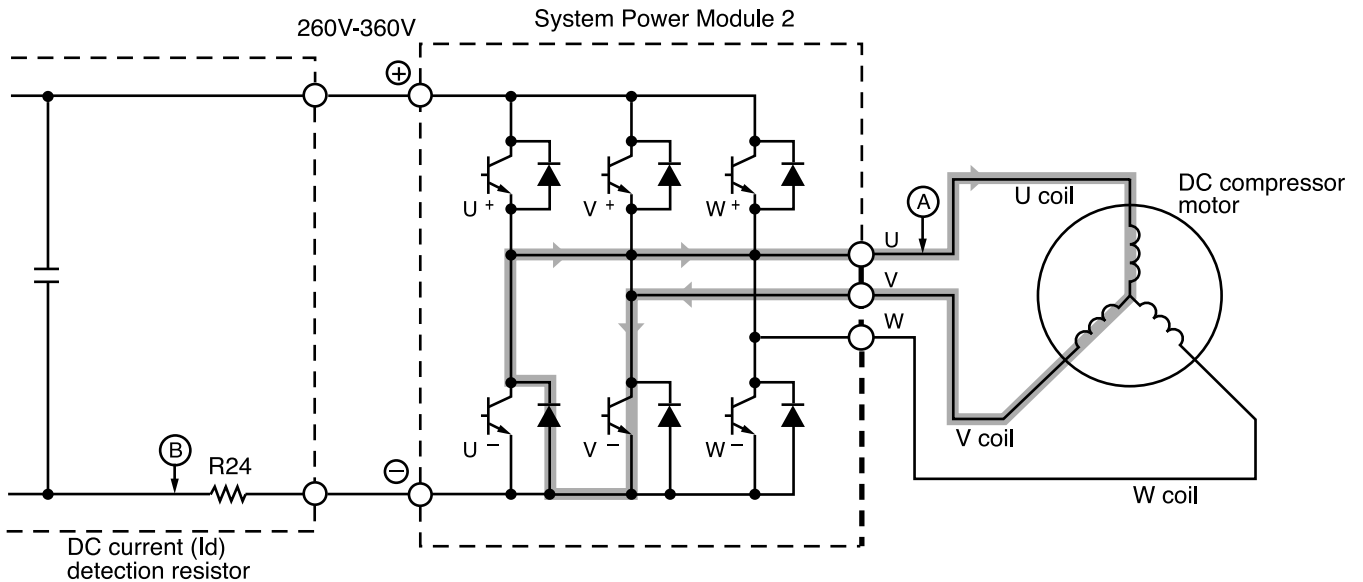

Fig. 3-4 Power module circuit (U⁺ is ON, V⁻ is ON)

- Since current flows at point B only when U⁺ transistor is ON, the current waveform at point B becomes intermittent waveform as shown in Fig. 3-3. Since current at point B is approximately proportional to the input current of the air conditioner, input current is controlled by using DC current (Id) detection resistor.

<Reference>

If power module is defective, self diagnosis lamps on the control P.W.B. may indicate as shown below:

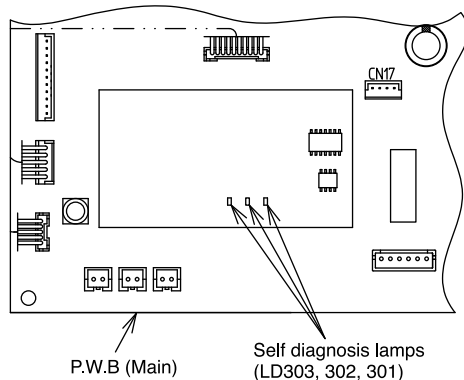

Fig. 3-5

Table 3-1

Self-diagnosis	Self-diagnosis lamp and mode	
Ip (peak current cut)	LD301	Blinks 2 times
Abnormal low speed rotation	LD301	Blinks 3 times
Switching incomplete	LD301	Blinks 4 times

- Simplified check of power module (Lighting mode when operated with compressor leads disconnected)
 - (1) Disconnect connector of 3-pole (WHT, YEL, RED) lead wire connecting to compressor located at the lower part of electric parts box.
 - (2) Set to compressor operation state (other than FAN mode) and press Start/stop switch of remote control.
 - (3) If normal operation continues for more than 1 minute (LD303 lights), power module is considered normal.
- * Refer to other item (troubleshooting on page 121) for independent checking of power module.

4. Power Circuit for P.W.B.

- Fig. 4-1 shows the power circuit for P.W.B. and waveform at each point.

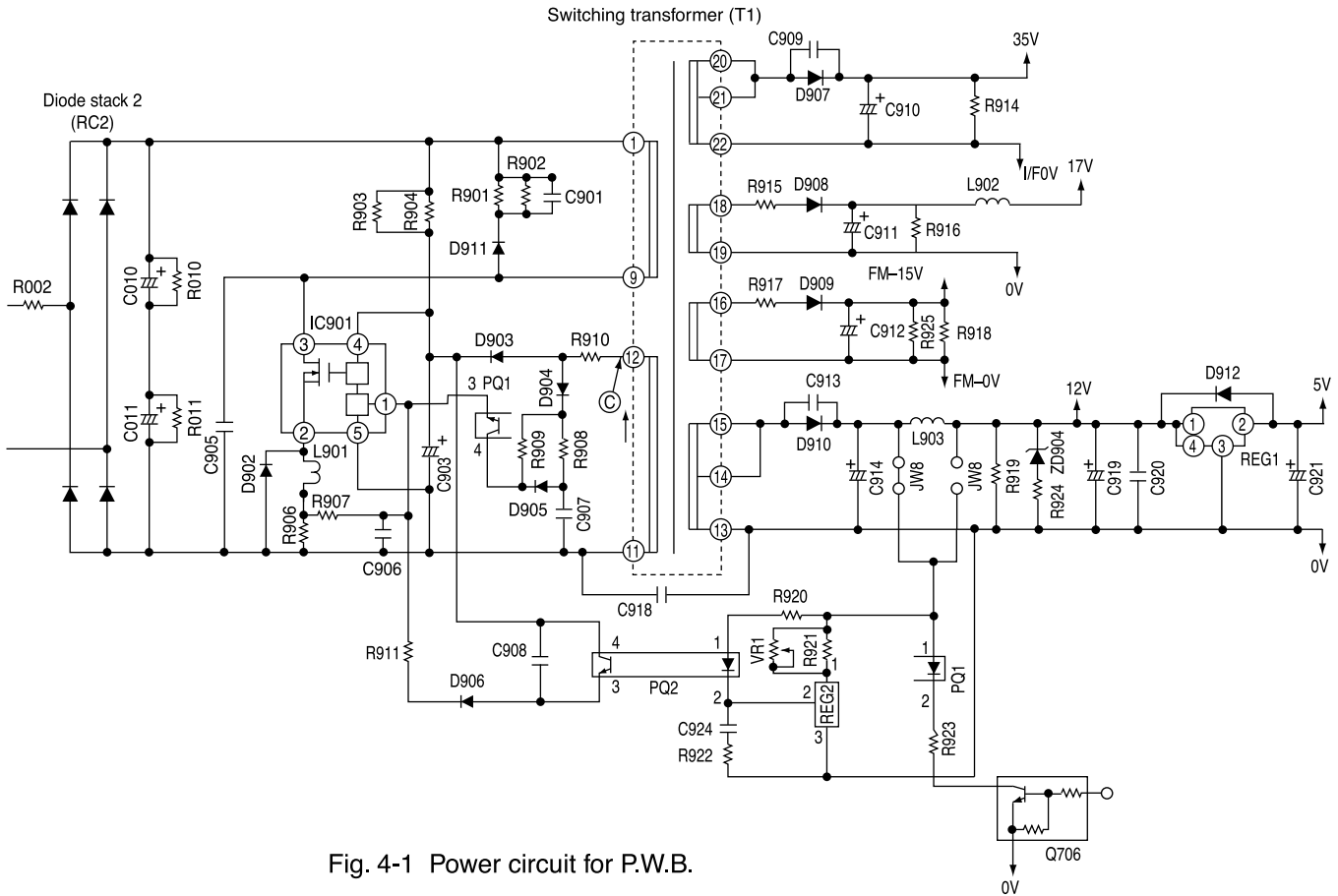

Fig. 4-1 Power circuit for P.W.B.

- In the power circuit for P.W.B., power supply for microcomputer, peripheral circuits, and system power module driver circuit and, as well as DC 35V, are produced by switching power circuit.
- Switching power circuit performs voltage conversion effectively by switching transistor IC901 to convert DC 330V voltage to high frequency of about 20kHz to 200kHz.
- Transistor IC901 operates as follows:

(1) Shifting from OFF to ON

- DC about 330V is applied from smoothing capacitors C010 ⊕ and C011 ⊖ in the control power circuit. With this power, current flows to pin ④ of IC901 via R903 and R904 and IC901 starts to turn ON. Since voltage in the direction of arrow generates at point © at the same time, current passing through R910 and D903 is positive-fed back to IC901.

(2) During ON

- The drain current at IC901 increases linearly. During this period, the gate voltage and current become constant because of the saturation characteristics of the transformer.

(3) Shifting from ON to OFF

- This circuit applies a negative feedback signal from the 12V output. When the voltage across C919 reaches the specified value, REG2 turns on and current flows to PQ2 ①-②. This turns the secondary circuits on, sets IC901 pin ① to "Hi", and turns IC901 off.

(4) During OFF

- While IC901 is on, the following energy charges the primary windings of the transformer:

Energy=LI²/2. Here, L : Primary inductance

I : Current when IC1 is off

This energy discharges to the secondary windings during power off. That is, C910, C911, C912, C914 is charged according to the turn ratio of each winding.

- At the start, an overcurrent flows to IC901 because of the charged current at C910, C911, C912, C914.
- The drain current at IC901 generates a voltage across R906. If it exceeds the IC901 base voltage, it sets the IC901 gate voltage to "HI".
- R906 limits the gate voltage to prevent excessive collector current from flowing to IC901.

<Reference>

If the power circuit for P.W.B. seems to be faulty:

- (1) Make sure that 5V and 12V on the control P.W.B., upper arm U, V and W, and the lower arm power voltage are the specified values.

- (2) When only the 5V output is low:

REG 1 (regulator) faulty, 5V-0V shorted, output is too high, or REG 1 is abnormal.

- (3) When 12V and 5V are abnormal:

The following defects can be considered:

① Fan, operation, power, rush prevention relay (shorting in relay, etc.)

② Microcomputer is abnormal.

③ REG 1 (regulator is abnormal), etc.

Shorting on primary circuits.

When shorting occurs in the secondary circuits, there is no abnormality in the primary circuits because of overcurrent protection.

The voltage rises when an opening occurs in the primary circuits, or the feedback system is abnormal.

- (4) When 15V and 17V are abnormal:

D908, D909 or drive circuit is abnormal.

- (5) When all voltage are abnormal:

IC901, R906, etc. are possibly abnormal.

- * If IC901 is abnormal, be aware that other components, such as the power module, REG (regulator), etc. are possibly defective.

[When the switching power supply seems to be abnormal, the voltage between IC901 pin ④ (to be measured at the leads of R904 and R903) and IC901 pin ⑤ (to be measured at R906 lead) may be between 11 and 16V. This is because the protection circuit of IC901 is operating.]

5. Reversing valve control circuit

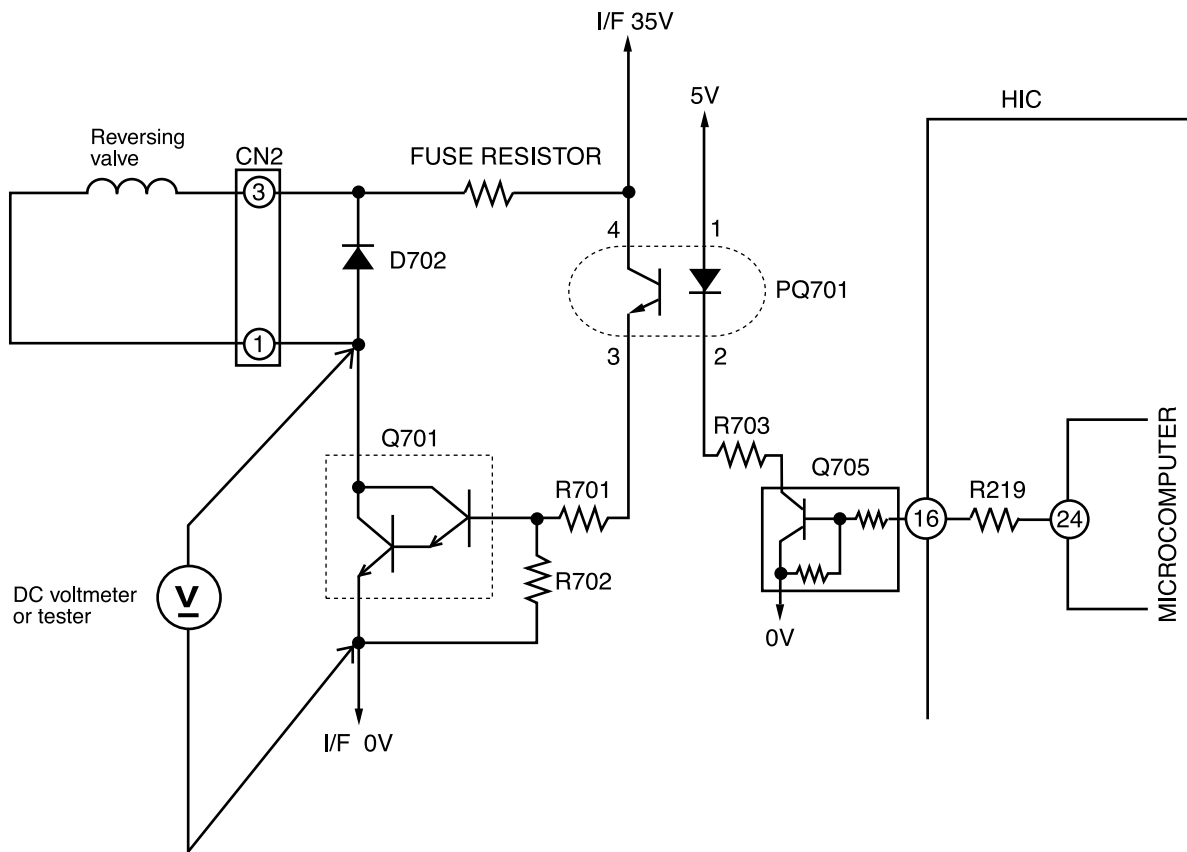

Fig. 5 - 1

- Reversing valve control circuit can switch reversing valve ON/OFF according to instruction from indoor microcomputer depending on the operation condition shows in Table 5-1. Voltage at each point in each operation condition is approximately as shown below when measured by tester. (When collector voltage of Q701 is measured)

Table 5-1

Operation condition		Collector voltage of Q701
Cooling	General operation of Cooling	About 35V
Heating	In normal heating operation	About 0.8V
	MAX. rotation speed instructed by indoor microcomputer after defrost is completed	About 0.8V
	Defrosting	About 35V
Dehumidifying	Sensor dry	About 35V

6. Rotor magnetic pole position detection circuit

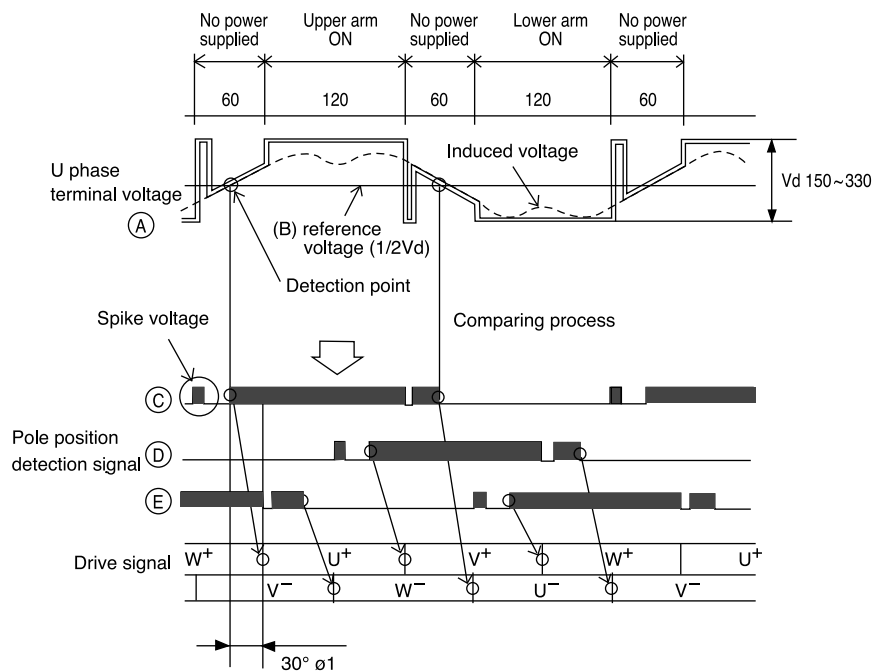
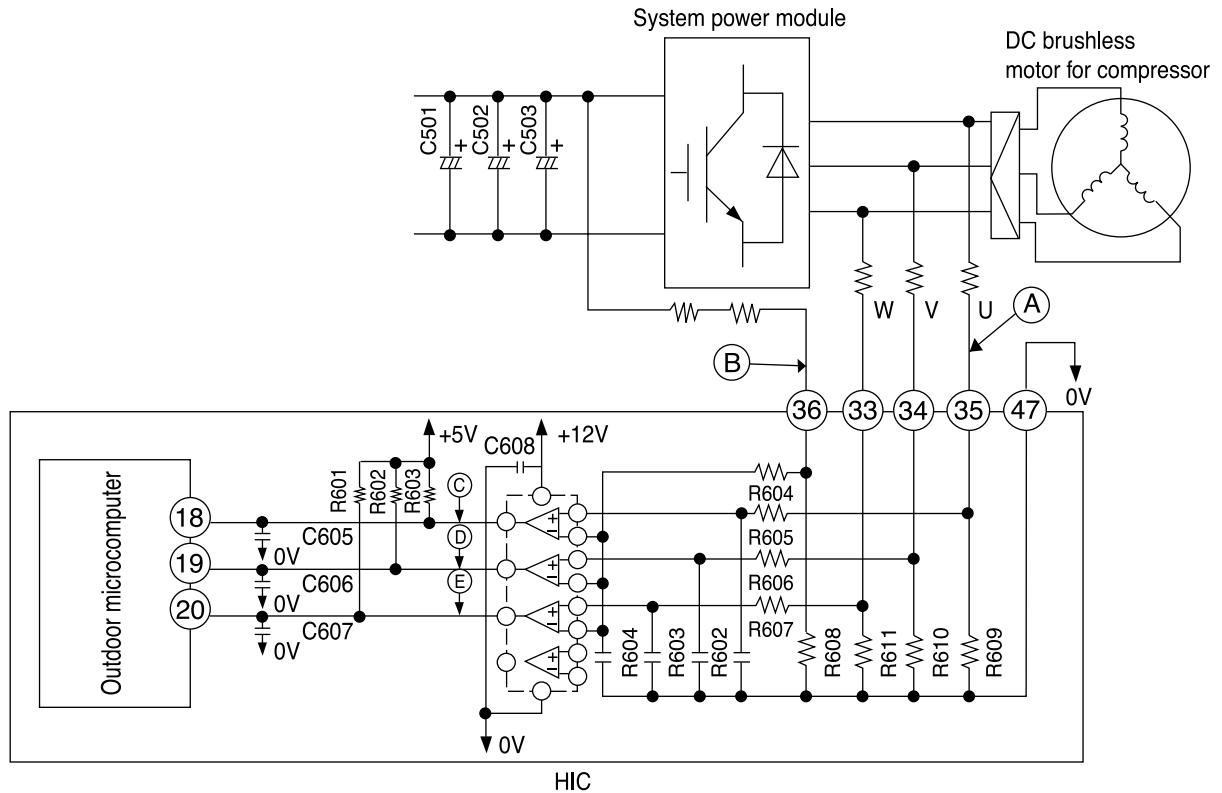

Fig. 6-1 Rotor magnetic pole position detection circuit and voltage waveform at each point

- To detect U phase, voltage at point © is produced by driving motor induced voltage signal (voltage at point ①) and 1/2 voltage of V_d (voltage at point ②), and comparing with comparator.
- For V phase and W phase, voltage at point ④ and voltage at point ⑤ are produced in the same way as above. Voltage at point © is taken into indoor unit microcomputer, switching timing to U^+ transistor from W^+ transistor is produced by delaying 30° from rise waveform, ignoring spike voltage. In addition, switching timing to U-transistor from W-transistor is produced by delaying 30° from fall waveform.
- For V phase and W phase, in the same way as above, drive signals are produced from voltages at point ④ and point ⑤. Phases are shifted by 120° and 240° , respectively, comparing with U phase.

7. Drive Circuit

Fig. 7-1 shows the drive circuit. The circuits for U phase, V phase and W phase have the same Configuration.

- In low speed rotation mode (PWM range), as shown in Fig. 7-2, 0-5V chopper signal is output from microcomputer for each phase. Signal output from microcomputer is output to IC1 and is inverted by active Lo to become 0-15V chopper signal; it is then drive the transistor of each phase.
- In high speed rotation mode (PWM range), as shown in Fig. 7-3, 0-5V drive signal is output from microcomputer for each phase (with no chopper because of full duty). Signal output from microcomputer is input to IC1 and is inverted by active Lo to become 0-15V drive signal; it is then drive the transistor of each phase.

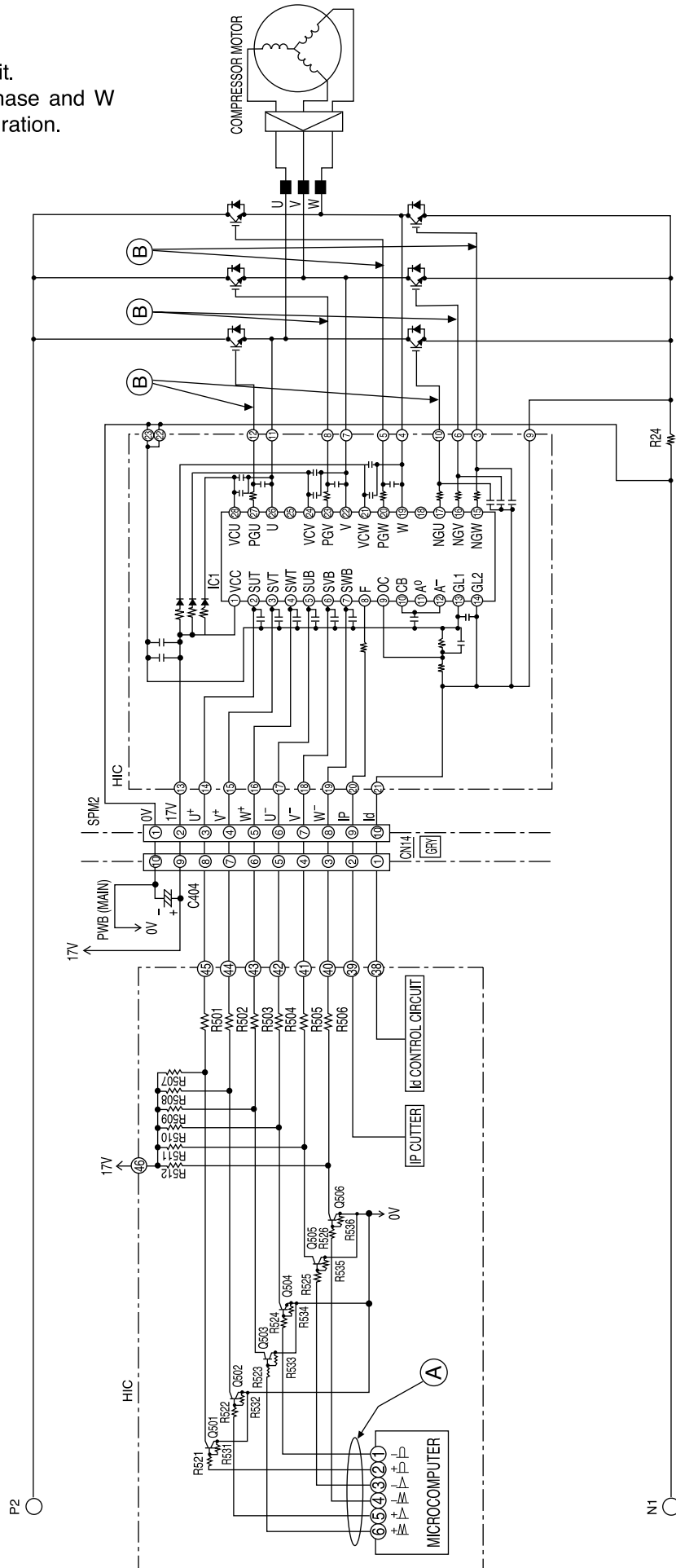

Fig.. 7-1

[Low speed rotation mode]

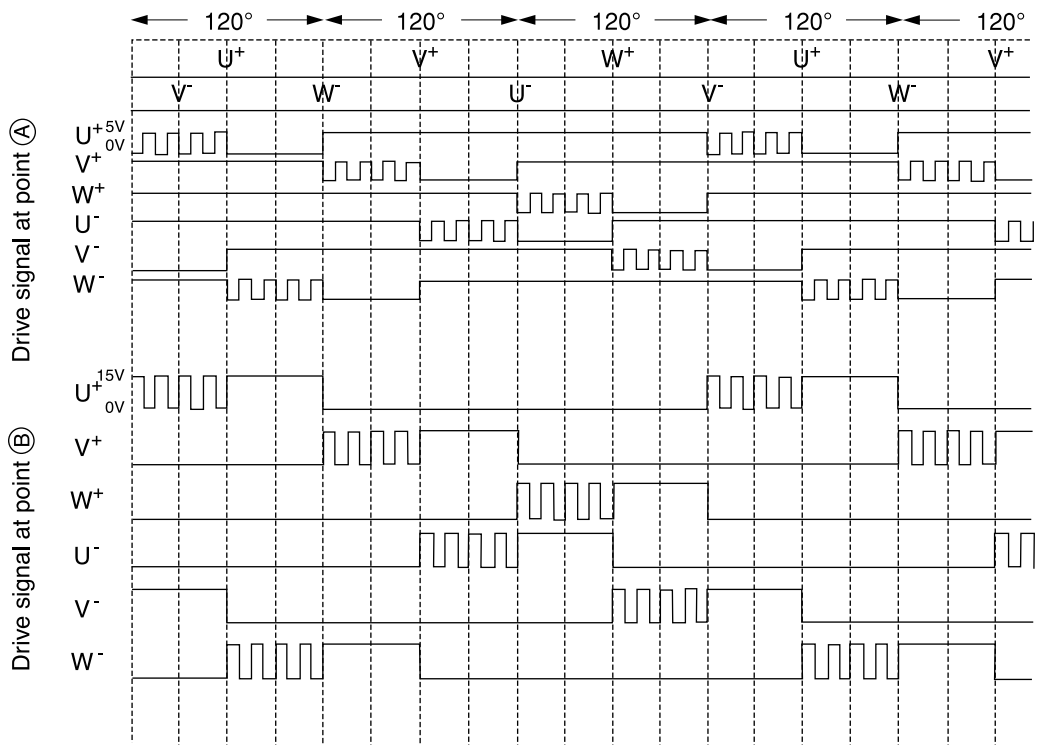

Fig. 7-2

[High speed rotation mode]

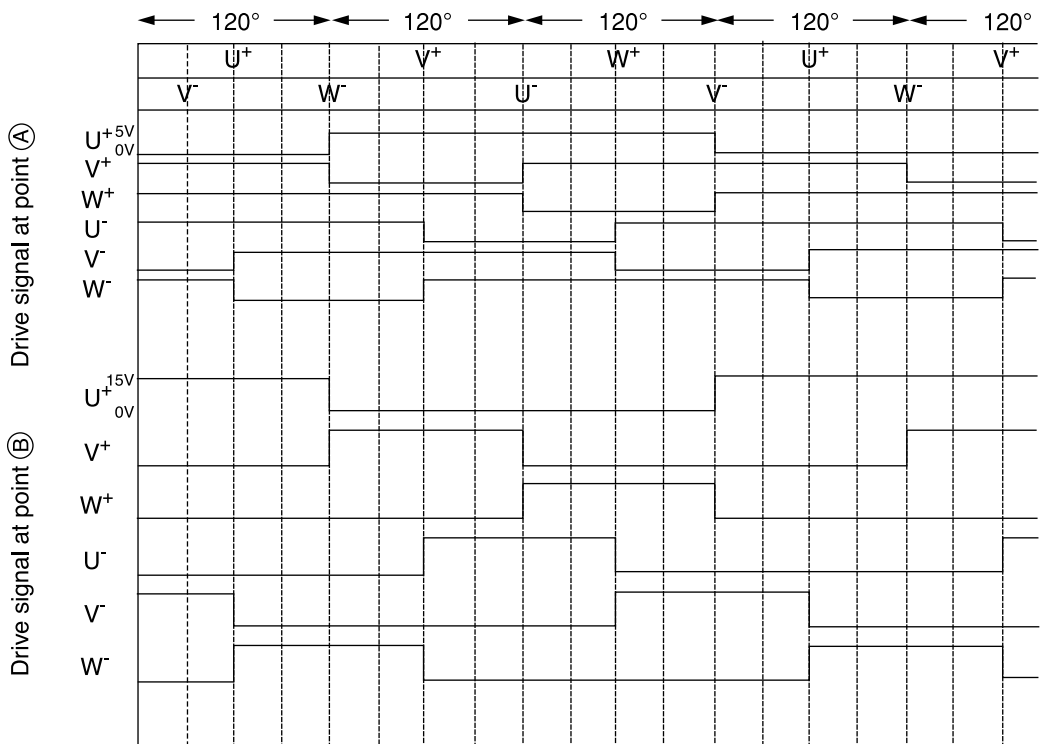

Fig. 7-3

8. HIC and Peripheral Circuits

- Fig. 8-1 shows the micro computer and its peripheral circuits, Table 8-1, the basic operations of each circuit block, and Fig. 8-2, the system configuration.

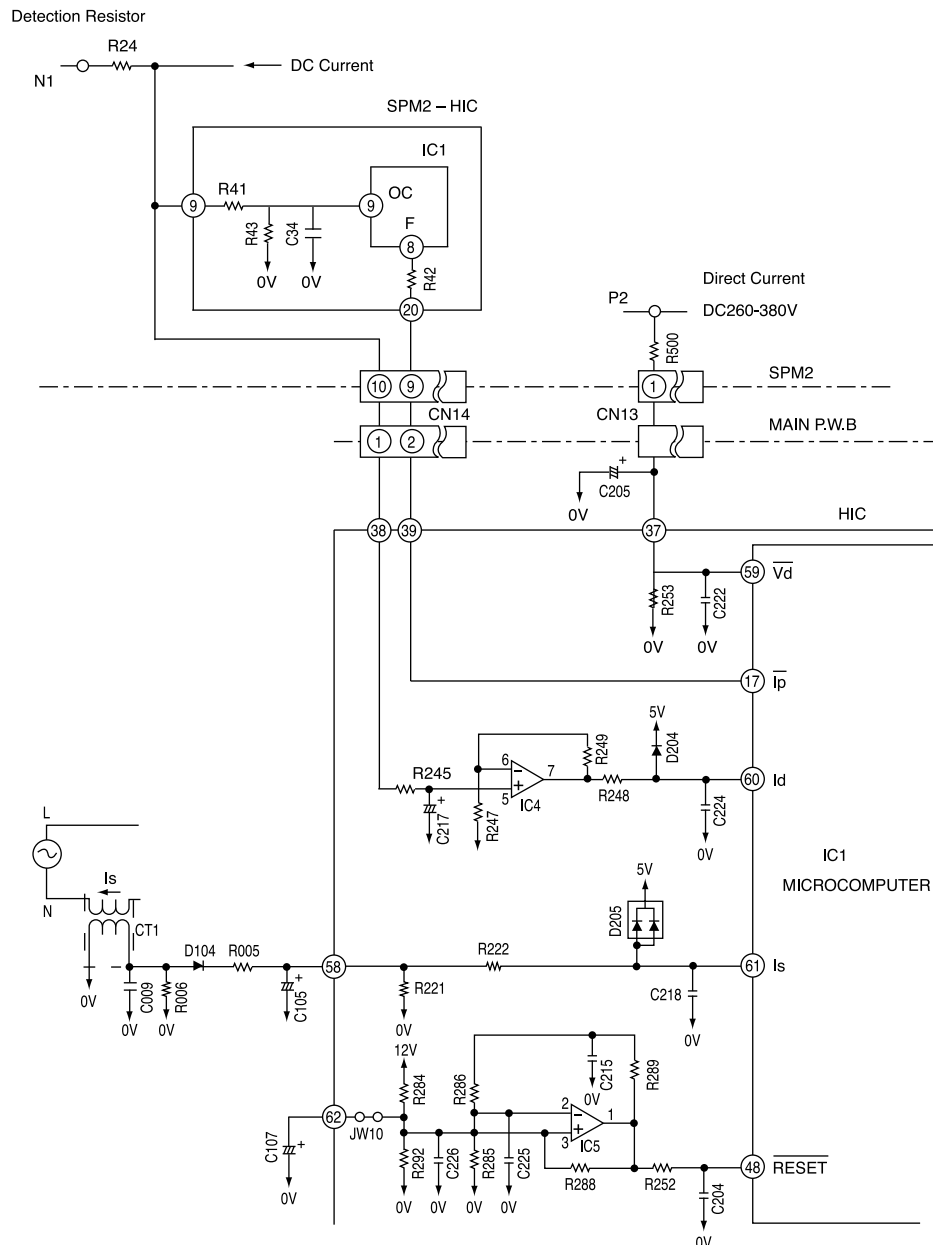

Fig. 8-1 Microcomputer and Peripheral Circuits

Table 8-1

Circuit block	Basic operation
Peak current cutoff circuit	Detects DC current flowing power module and during overcurrent (instantaneous value) flows, stops upper/lower arm drive circuits and also produces Ip signal by which drive signal output is stopped.
Set value circuit	Compares voltage detected, amplified and input to HIC with set voltage value in microcomputer, and controls overload when set value exceeds input voltage.
Voltage amplifier circuit	Voltage-amplifies DC current level detected by the detection resistor and inputs this to microcomputer. Internal or external overload is judged in microcomputer.
Reset circuit	Produces reset voltage.
Trip signal synthesis circuit	Modulates chopper signal to drive signal and stops according to presence/absence of Ip signal or reset signal.

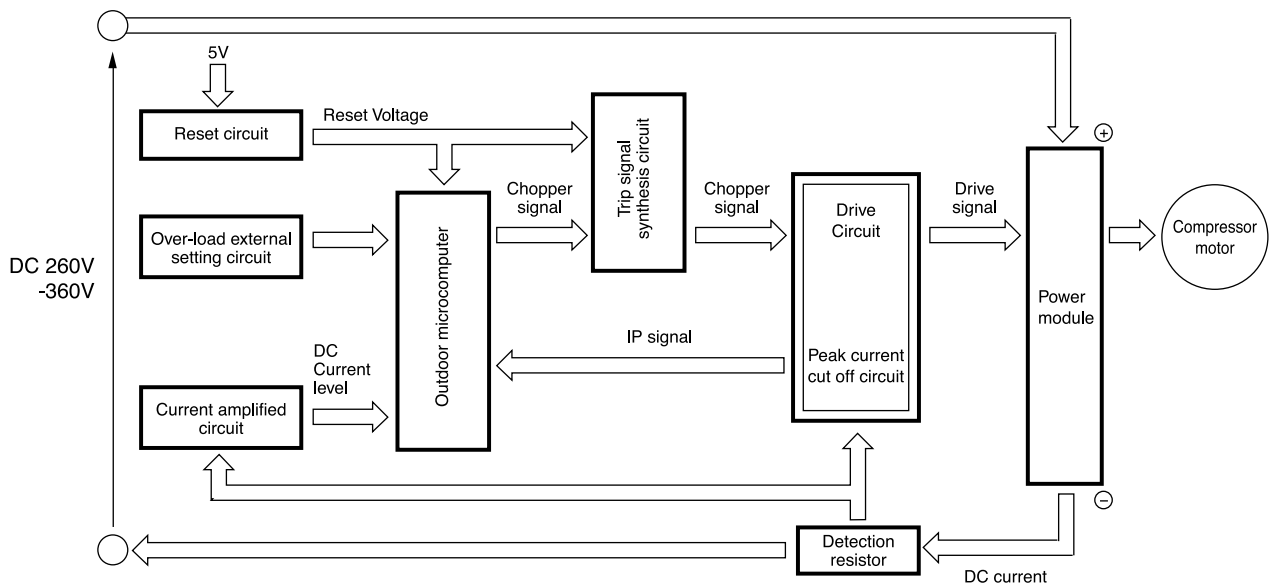

Fig. 8-2

- The following describes the operations of each circuit in detail.

(1) Peak current cut off circuit

Fig.8-3 Peak Current Cut off Circuit and Waveforms at Each Section.

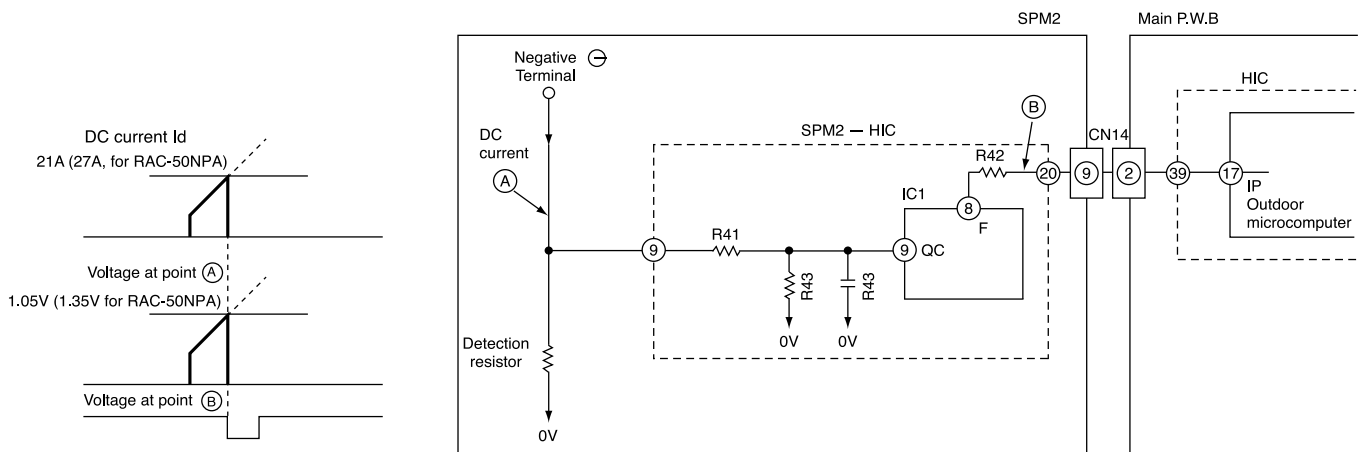

Fig.8-3

- The Ip cut off circuit detects an instantaneous excessive current and stops inverter to protect parts such as SPM2, etc.
- As shown in diagram, if current exceeding 21A (27A for RAC-50NPA) flows, voltage at point (A) recognized by detecting resistor is input to pin ⑩ of SPM2 – HIC, and voltage divided by R41 and R43 is input to pin ⑨ of IC1. Since threshold of IC1 is exceeded in this case, Lo signal is input from pin ⑧ (Voltage at point (B)). When Lo signal is input to pin ⑰ of microcomputer, microcomputer stops drive output.
- When drive output from microcomputer is stopped, all drive output goes Hi, and microcomputer is initialized to enter drive signal standby mode. 3 minutes later, microcomputer outputs drive signal again, to start operation.

(2) Overload control circuit (OVL control circuit)

- Overload control is to decrease the speed of the compressor and reduce the load when the load on the air conditioner increases to an overload state, in order to protect the compressor, electronic components and power breaker.
- Overloads are judged by comparing the DC current level and set value.
- Fig. 8-4 shows the overload control system configuration and Fig. 8-5 is a characteristic diagram of overload judgement values. There are two judgement methods-external judgement which compares the externally set value with the DC current value regardless of the rotation speed and internal judgement which compares the set value that varies according to the rotation speed programmed in the microcomputer software with the DC current value.

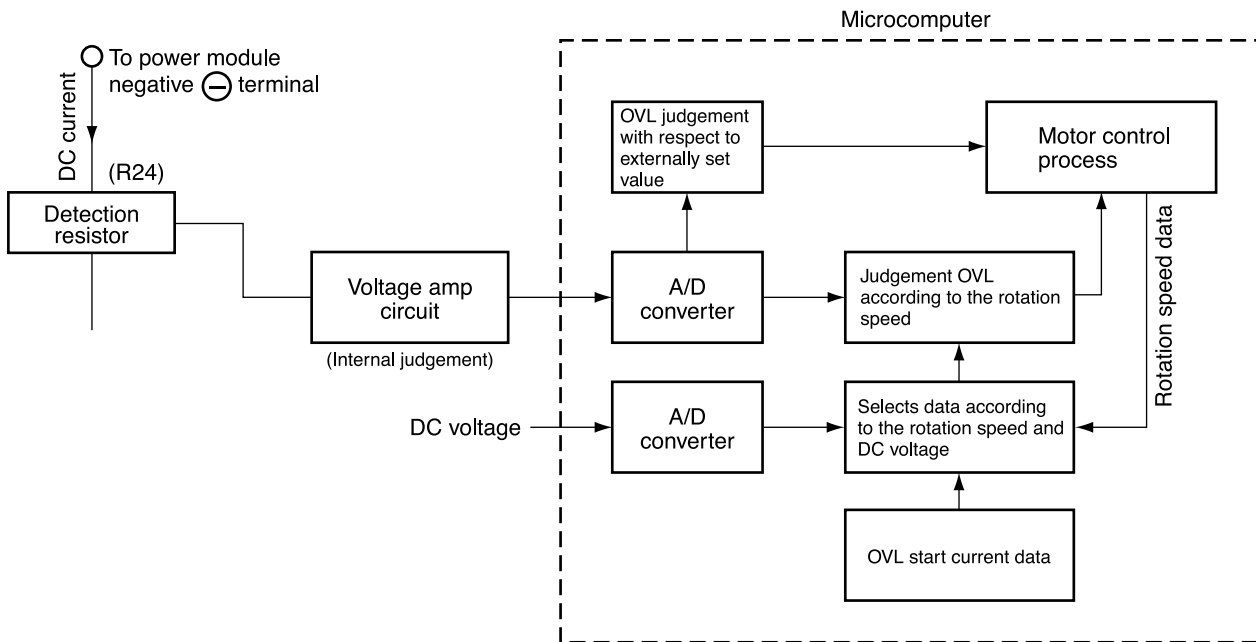

Fig. 8-4 Overload Control System Configuration

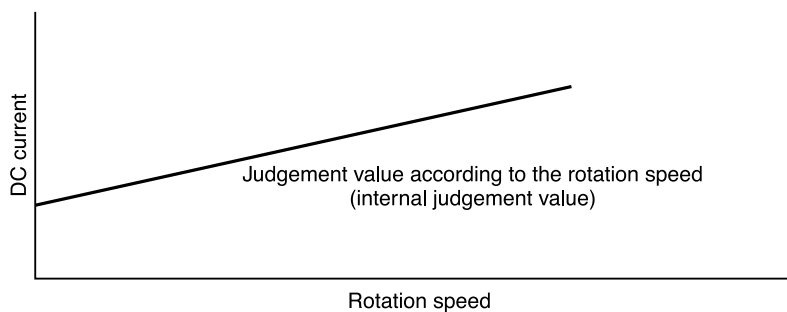

Fig. 8-5

①. Overload external judgement circuit

- Fig. 8-1. The filter consisting of R245 and C217 removes high harmonic components from the voltage generated by the current flowing to Detection resistor; R245 and C217 average the voltage. This voltage is then input to IC4 pin ⑤ is then amplified and supplied to microcomputer pin ⑥. The microcomputer compares this input with the internally set value, and if the input exceeds the set value, it enters overload control status.
- Fig. 8-7 shows the rotation speed control. When the voltage at pin ⑥ of the microcomputer exceeds the set value, the microcomputer decreases the rotation speed of the compressor and reduces the load regardless of the rotation speed commanded by the indoor microcomputer.

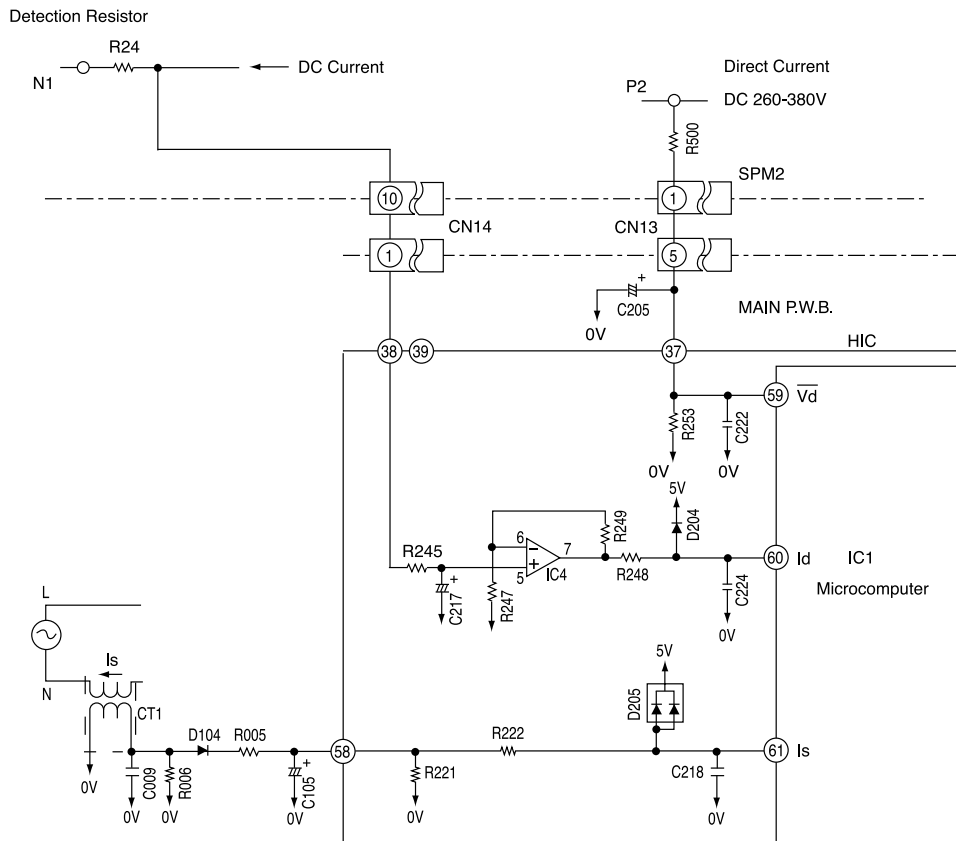

Fig. 8-6

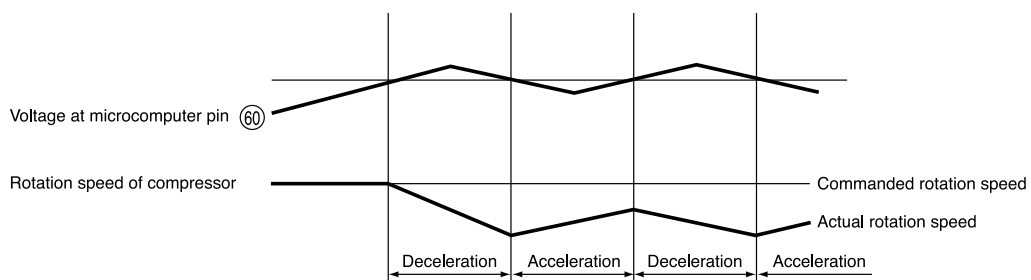

Fig. 8-7

②. Voltage amp. circuit

- The voltage amp. circuit amplifies the DC current level detected by the detection resistor after being converted to a voltage and supplies it to the microcomputer. Receiving this, the microcomputer converts it to a digital signal and compares it with the internal data to judge whether or not overload control is required.

< During overload control >

- The filter consisting of R245 and C217 removes high harmonic components from the voltage generated from the DC current flowing to the detection resistor, and supplies it to IC4 pin ⑤ IC4 forms a non-inverting voltage amp. circuit together with the peripheral elements.
- The microcomputer stores the set values which vary according to the rotation speed. When the DC current level exceeds the set value, the microcomputer enters the overload control state.
- The set Value is determined by the amplification of the voltage amp. circuit.

- Amplification : high → DC current : low
- Amplification : low → DC current: high

- R500, R253, detect the DC voltage at the power circuit. The microcomputer receives a DC voltage (260-380V) via HIC ③7 and applies correction to the overload set value so the DC current is low (high) when the DC voltage is high (low).

(Since the load level is indicated by the DC voltage multiplied by DC current, R247, R248, R249 are provided to perform the same overload judgement even when the voltage varies.)

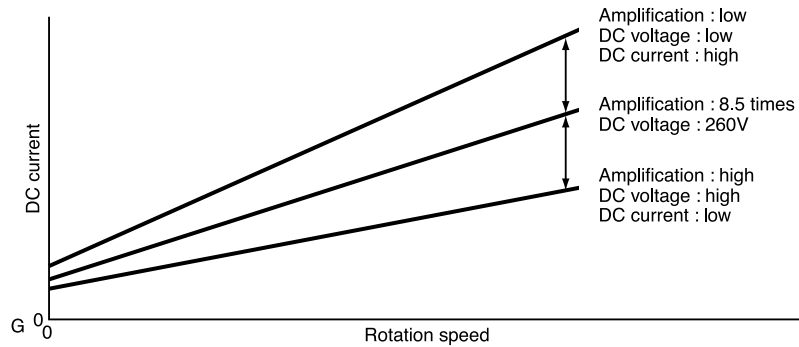

Fig. 8-8

< During start current control >

- It is required to maintain the start current (DC current) constant to smooth the start of the DC motor for the compressor.
- RAC-25NPA, RAC-35NPA, RAC-50NPA uses software to control the start current.
- The start current varies when the supply voltage varies. This control method copes with variations in the voltages as follows.

(1) Turns on the power module's U⁺ and V⁻ transistors so the current flows to the motor windings as shown in Fig8-9.

(2) Varies the turn-ON time of the W⁺ transistor according to the DC voltage level and the start is controlled so the start current is approx. 10A as shown in Fig. 8-10.

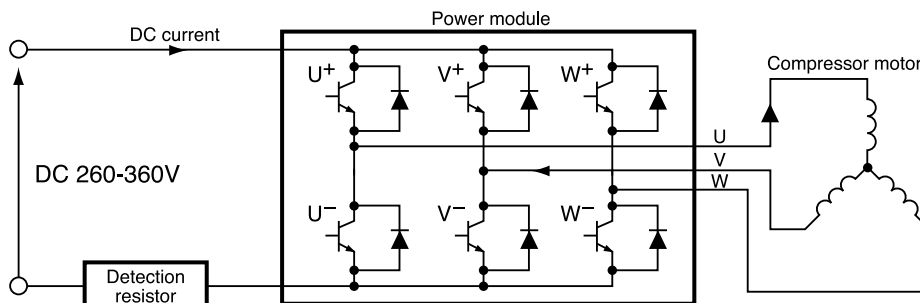

Fig. 8-9

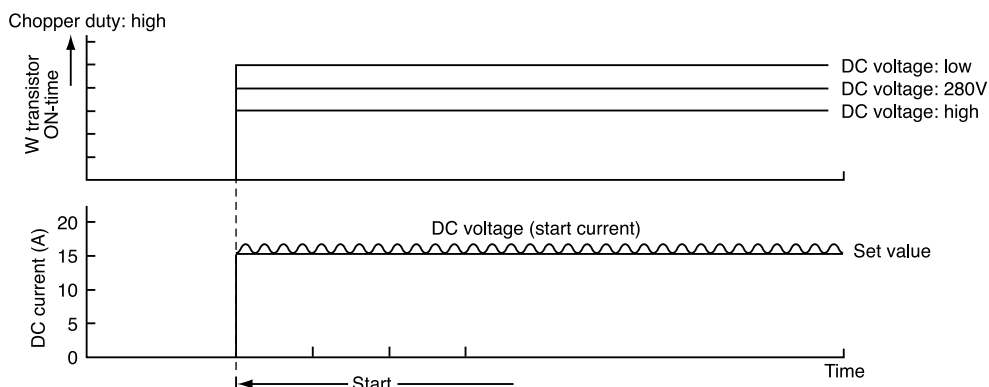

Fig. 8-10

9. Temperature Detection Circuit

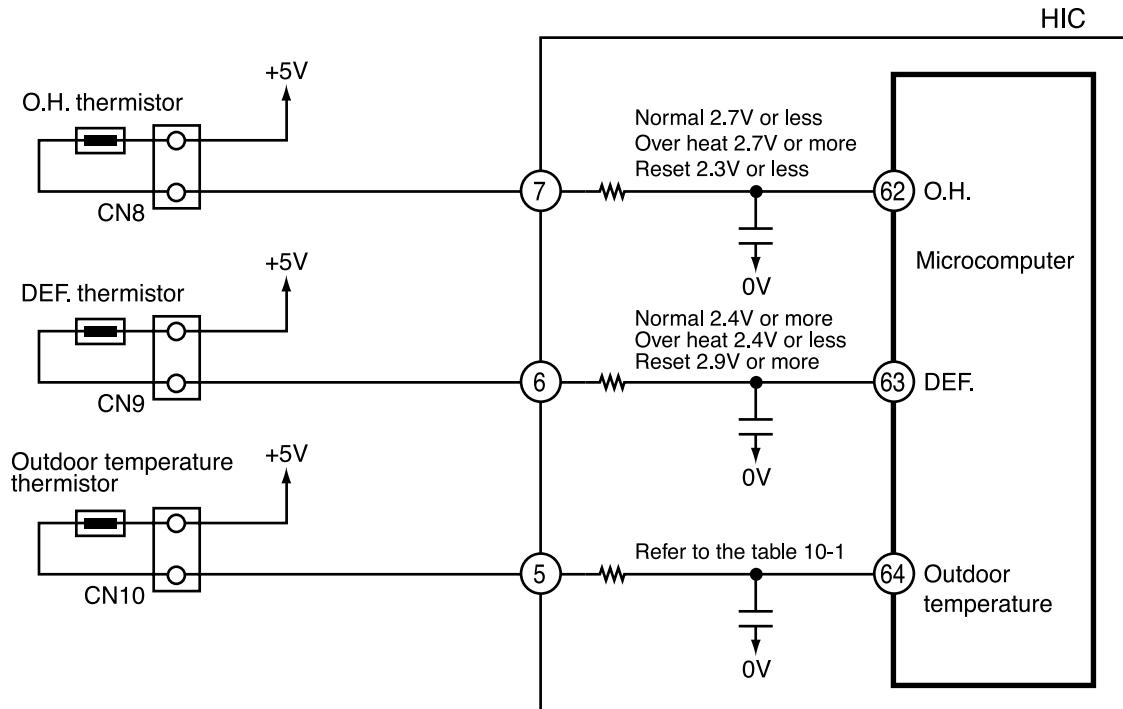

Fig. 9-1

- The Over heat thermistor circuit detects the temperature at the surface of the compressor head, the Defrost. thermistor circuit detects the defrosting operation temperature.
- A thermistor is a negative resistor element which has the characteristics that the higher (lower) the temperature, the lower (higher) the resistance.
- When the compressor is heated, the resistance of the Over heat thermistor becomes low and voltage at pin ⑥② of microcomputer is increased.
- Microcomputer compares the voltage present at pin ⑥② with the internal set value, if it is exceeded the set value microcomputer judges that the compressor is overheated and stops operation.
- When frost forms on the outdoor heat exchanger, the temperature at the exchanger drops abruptly. Therefore the resistance of the Defrost. thermistor becomes high and the voltage at pin ⑥③ of microcomputer drops. If this voltage becomes lower than the set value stored inside, the microcomputer starts defrosting control.
- During defrosting operation the microcomputer transfers the defrosting condition command to the indoor microcomputer via the circuit interface.
- The microcomputer always reads the outdoor temperature via a thermistor (microcomputer pin ⑥④), and transfers it to the indoor unit, thus controlling the compressor rotation speed according to the value set at the EEPROM in the indoor unit, and switching the operation status (outdoor fan on/off, etc.) in the dry mode.

The following shows the typical values of outdoor temperature in relation to the voltage:

Table 9-1

Outdoor temperature (°C)	-10	0	10	20	30	40
Microcomputer pin ⑤ voltage (V)	1.19	1.69	2.23	2.75	3.22	3.62

<Reference>

When the thermistor is open, in open status, or is disconnected, microcomputer pins ⑥②—⑥④ are approx. 0V; when the thermistor is shorted, they are approx. 5 V, and LD301 blinks seven times.

However, an error is detected only when the OH thermistor is shorted; in such a case, the blinking mode is entered 12 minutes after the compressor starts operation.

10. Reset Circuit

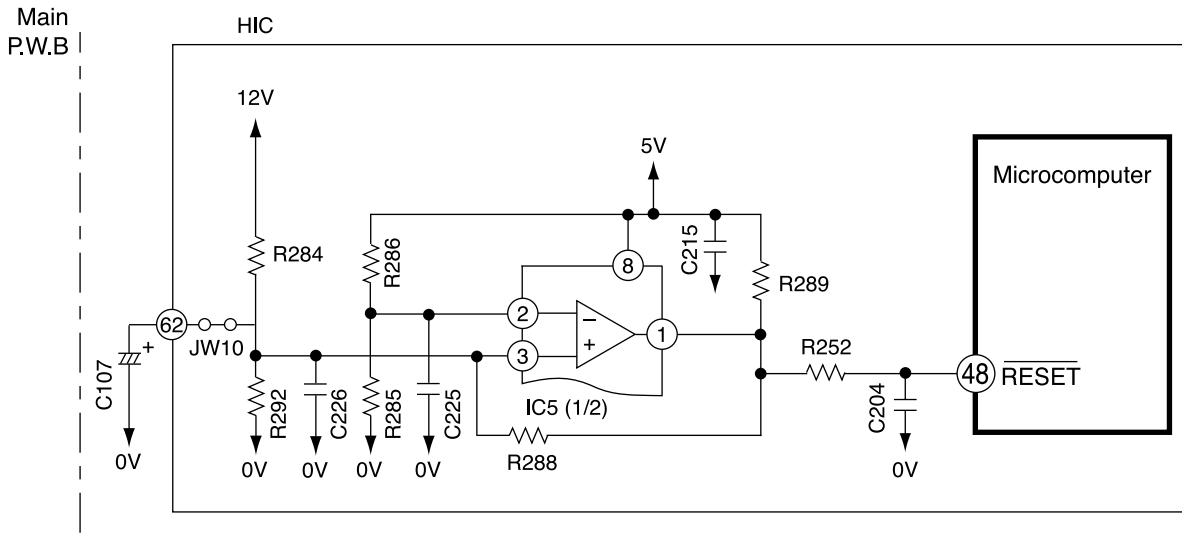

Fig. 10-1

- The reset circuit initializes the microcomputer program when Power is “ON” or “OFF”.
- Low voltage at pin ④⑧ resets the microcomputer, and HI activates the microcomputer.
- Fig. 10-1 shows the reset circuit and Fig. 10-2 shows waveform at each point when power is turned on and off.
- When power is turned on, 12V line and 5V line voltages rise and 12V line voltage reaches 10.9V and reset voltage input to pin ④⑧ of microcomputer is set to Hi.
- Reset voltage will be hold “Hi” until the 12V line voltage drops to 9.90V even though the power shuts down.

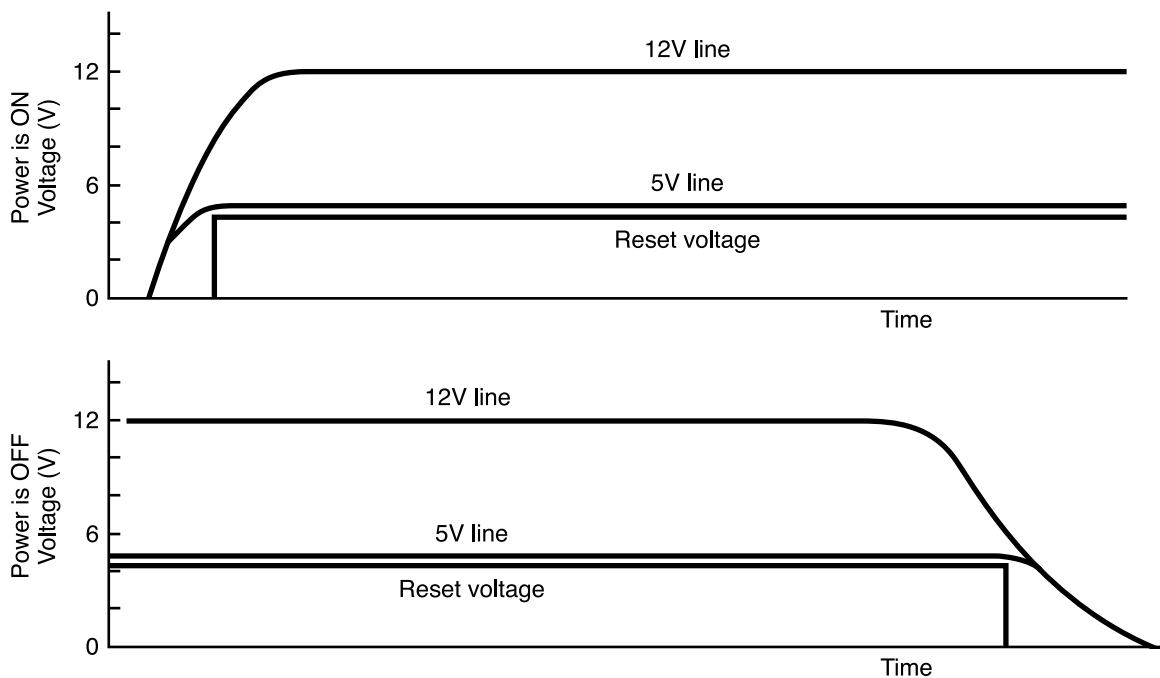

Fig. 10-2

11. Outdoor DC Fan Motor control circuit.

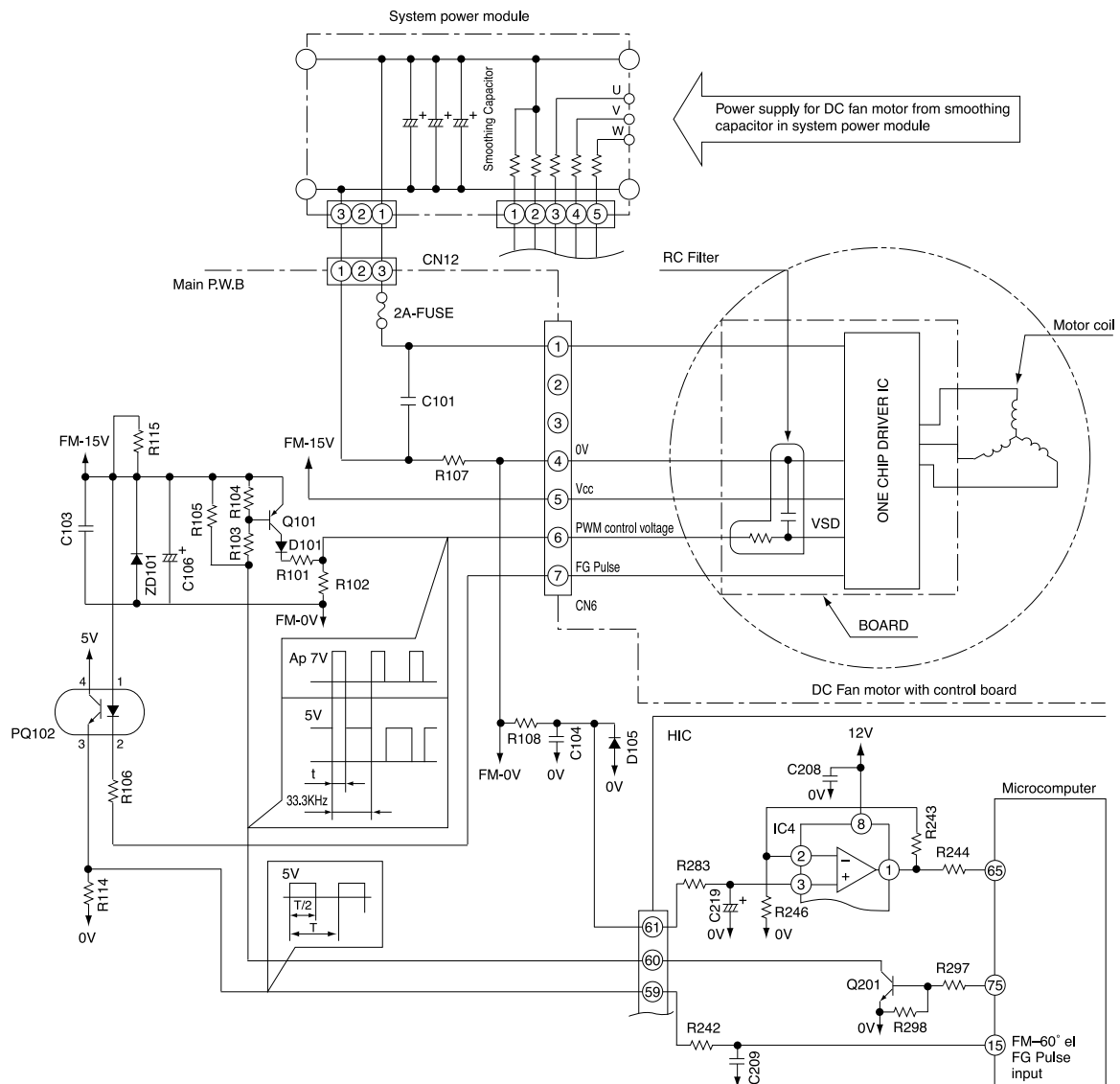

Fig. 11-1

- This model uses DC Fan Motor which has a controller circuit in the Motor.
- This DC Fan Motor will rotate by control voltage apply to Vsp input. (Voltage range: 1.7 to 7V DC)
Vsp high : Faster ; Vsp low : slower ; Vsp lower than 1.7V : stop
- Motor will output FG pulse by following this motor revolution.
- Outdoor Microprocessor will output PWM control signal from FMCHOP terminal by following the instruction from indoor Microprocessor.
- This PWM control signal will convert to Vsp voltage by smoothing circuit (Q101 & RC filter)
- Fan motor will start to rotate when Vsp was proceeding over than 1.7V, and generate FG pulse by rotation speed.
- FG pulse will feed back to Outdoor Microprocessor through PQ102.
- PQ102 is the isolator between Microprocessor circuit and DC Fan Motor circuit, which has to match the Fan Motor revolution with instructed revolution. Such as...
FG feedback: Faster – Instruction: Slower ... Decrease pulse width
FG feedback: Slower – Instruction: Faster ... Increase pulse width
- FG pulse is also used for Fan Motor failure detection
- Microprocessor will monitor FG pulse 30 seconds after start the fan motor. If there is no signal detected, it will consider that the Fan Motor was malfunction and stop the operation. In this case, LD302 on control PWB will blink 12 times. (Fan Motor lock detected)
- R107 and IC4 are used for Fan Motor over current

< Reference >

- When operation stop with LD301 blinks 12 times, it may be caused by faulty DC fan motor.
- In this case, please check CN6 and CN12 connection first. It makes Fan Motor Lock also if those connectors are in misconnection.
- DC Fan Motor has broken when 2A Fuse was burned. Please replace both DC Fan Motor and 2A Fuse together.
- It will makes "Fan Lock Stop" when something has disturb the Fan rotation by inserting materials into propeller fan or ice has growing inside of outdoor unit by snowing.
- It may make "Fan Lock Stop" by strong wind (ex. 17m/sec or above) against the Fan rotation. In this case, unit will be restart again after a while.
- In case of "Fan Lock Stop" even though the DC Fan Motor is rotating correctly, the possible casue is Fan Motor problem or PQ102 on board or control board problem. Stop after the Fan motor runs 2 minutes, Fan Motor may be broken.

< Caution >

- Please take care for the electrical shock by high voltage of DC Fan Motor power source which is common with compressor when you are servicing this unit.
- You can not confirm the coil and wiring of Motor due to the built in control circuit in Fan Motor.

12. Power Factor Control Circuit

Power factor is controlled to almost 100%. (Effective use of power)

With IC in ACT module, control is performed so that input current waveform will be similar to waveform of input voltage

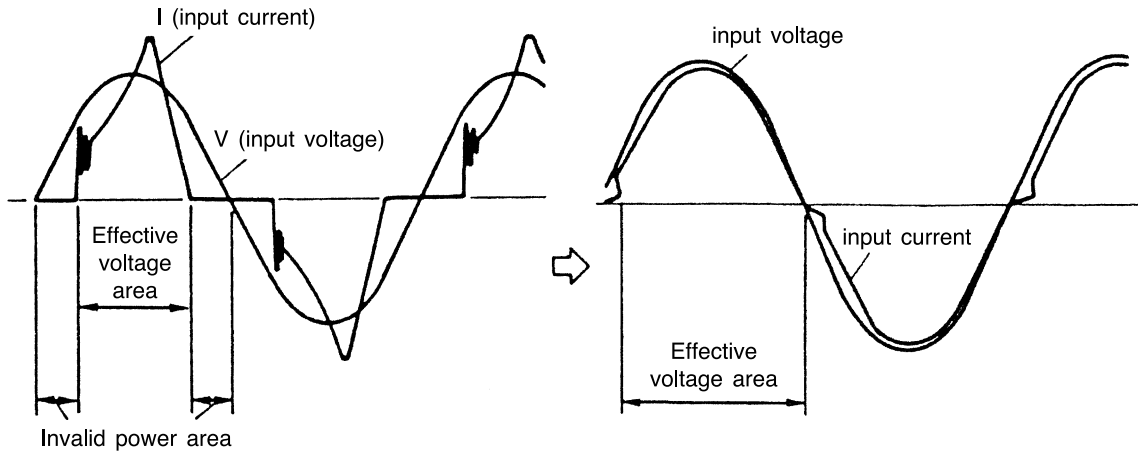

(Even if voltage is applied, current does not flow)

* Assuming the same current capacity (20A), power can be used about 10% effective, comparing with current use (power factor of 90%), and maximum capacity is thereby improved.

SERVICE CALL Q & A

Model RAD-18RPA, RAD-25RPA, RAD-35RPA, RAD-50RPA

COOLING MODE

Q1 The compressor has stopped suddenly during cooling operation.



A1 Check if the indoor heat exchanger is frosted. Wait for 3-4 minutes until it is defrosted.

If the air conditioner operates in cooling mode when it is cold, the evaporator may get frosted.

DEHUMIDIFYING MODE

Q2 Sound of running water is heard from indoor unit during dehumidifying.



A2 Normal sound when refrigerant flows in pipe.

Q3 Compressor occasionally does not operate during dehumidifying.



A3 Compressor may not operate when room temperature is 10°C or less. It also stops when the humidity is preset humidity or less.

HEATING MODE

Q4 The circulation stops occasionally during Heating mode.



A4 It occurs during defrosting. Wait for 5-10 minutes until the condenser is defrosted.

Q5 When the fan speed is set at HIGH or MED, the flow is actually Weak.



A5 At the beginning of heating, the fan speed remains LOW for 30 seconds. If HIGH is selected, it switches to LOW and again to MED after additional 30 seconds.

Q6 Heating operation stops while the temperature is preset at "30".



A6 If temperature is high in the outdoor, heating operation may stop to protect internal devices.

AUTO FRESH DEFROSTING

Q7 After the ON/OFF button is pressed to stop heating, the outdoor unit is still working with the OPERATION lamp lighting.



A7 Auto Fresh Defrosting is carried out : the system checks the outdoor heat exchanger and defrosts it as necessary before stopping operation.

AUTO OPERATION

Q8 Fan speed does not change when fan speed selector is changed during auto operation.



A8 At this point fan speed is automatic.

NICE TEMPERATURE RESERVATION

Q9 When on-timer has been programmed, operation starts before the preset time has been reached.



A9 This is because “Nice temperature reservation” function is operating. This function starts operation earlier so the preset temperature is reached at the preset time. Operation may start maximum 60 minutes before the preset time.

Q10 Does “Nice temperature reservation” function operate during dehumidifying?



A10 It does not work. It works only during cooling and heating.

Q11 Even if the same time is preset, the operation start time varies.



A11 This is because “Nice temperature reservation” function is operating. The start time varies according to the load of room. Since load varies greatly during heating, the operation start time is corrected, so it will vary each day.

INFRARED REMOTE CONTROL

Q12 Timer cannot be set.



A12 Has the clock been set? Timer cannot be set unless the clock has been set.

Q13 The current time display disappears soon.



A13 The current time disappears in approx. 10 seconds. The time set display has priority.

When the current time is set the display flashes for approx 3 minutes.

Q14 The timer has been programmed, but the preset time disappears.



A14 Is the current time past the preset time? When the preset time reaches the current time, it disappears.

OTHERS

Q15 The indoor fan varies among high air flow, low air flow and breeze in the auto fan speed mode. (Heating operation)



A15 This is because the cool wind prevention function is operating, and does not indicate a fault.

The heat exchanger temperature is sensed in the auto speed mode. When the temperature is low, the fan speed varies among high air flow, low air flow and breeze.

Q16 Loud noise from the outdoor unit is heard when operation is started.



A16 When operation is started, the compressor rotation speed goes to maximum to increase the heating or cooling capability, so noise becomes slightly louder. This does not indicate a fault.

Q17 Noise from the outdoor unit occasionally changes.



A17 The compressor rotation speed changes according to the difference between the thermostat set temperature and room temperature. This does not indicate a fault.

Q18 There is a difference between the set temperature and room temperature.



A18 There may be a difference between the set temperature and room temperature because of construction of room, air current, etc. Set the temperature at a comfortable for the space.

Q19 Air does not flow immediately after operation is started.



A19 Preliminary operation is performed for one minute when the power switch on and heating or dehumidifying is set. The operation lamp blinks during this time for heating. This does not indicate a fault.

TROUBLE SHOOTING

Model RAC-25NPA, RAC-35NPA, RAC-50NPA

PRECAUTIONS FOR CHECKING



- Remember that the 0V line is biased to 155-170V in reference to the ground level.
- Also note that it takes about 10 minutes until the voltage fall after the power switch is turned off.

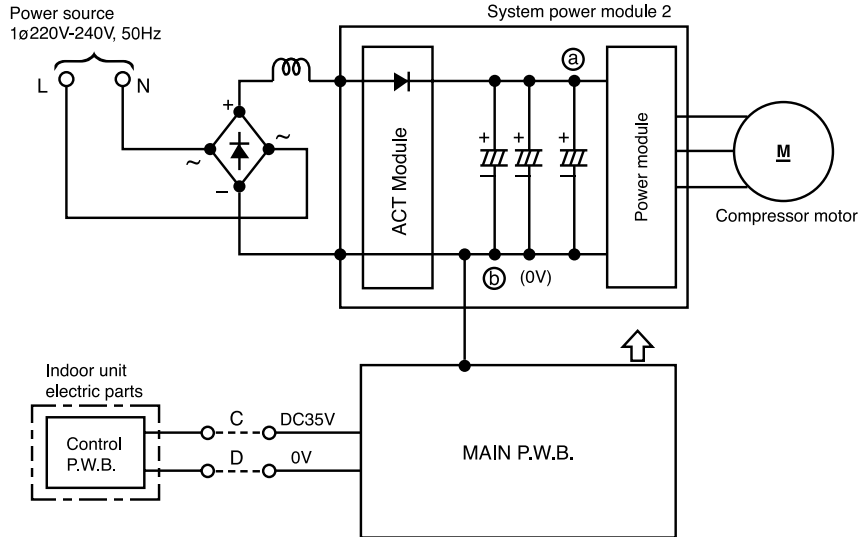

Across (a) – (b) (0V line)..... approx 260-360V
 Across (a) – ground..... approx 155-170V
 Across (b) (0V line)– ground..... approx 155-170V



When using an oscilloscope, never ground it. Don't forget that high voltages as noted above may apply to the oscilloscope.

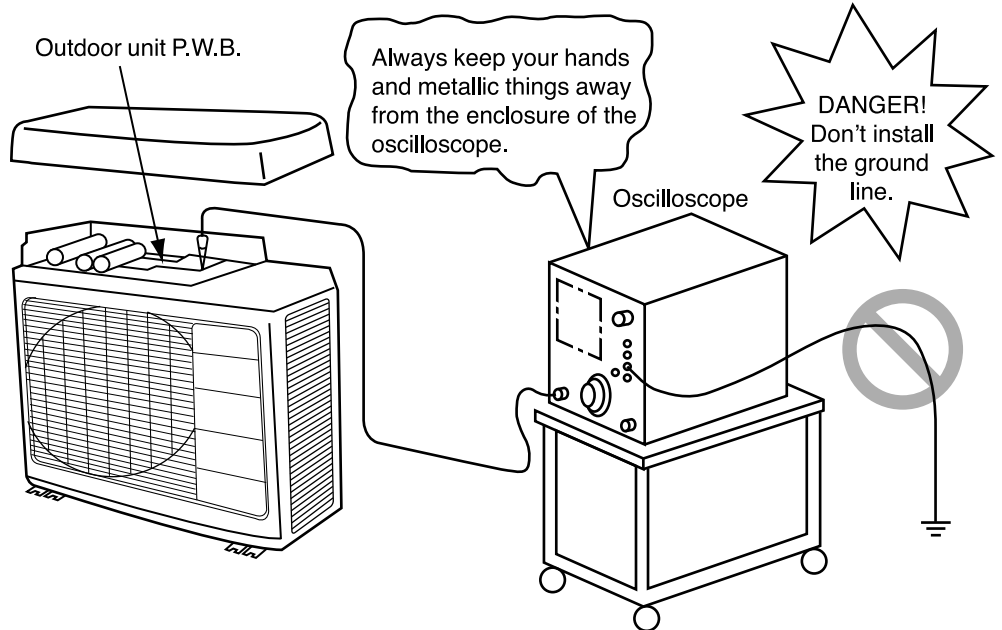

DISCHARGE PROCEDURE AND POWER SHUT OFF METHOD FOR POWER CIRCUIT



WARNING



Caution

- Voltage of about 300-330V is charged between both ends of smoothing capacitors
- During continuity check for each part of circuit in indoor unit electrical parts, disconnect red/gray lead wire connected from diode stack to system power module (SPM2) to prevent secondary trouble. (Be sure to discharge smoothing capacitor)

1. Turn OFF the Power supply to the outdoor unit.
2. After power is turned off, wait for 10 minutes or more. Then, remove electrical parts cover and apply soldering iron of 30 to 75W for 15 seconds or more to P2 and N1 terminals on system power module, in order to discharge voltage in smoothing capacitor.
3. Remove receptacle of red/gray lead wire connected to system power module from diode stack before performing operation check of each circuit.

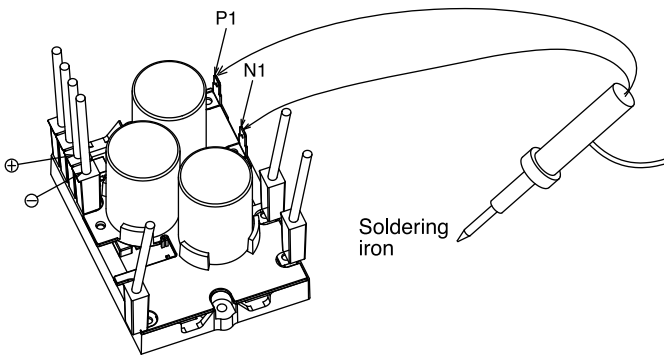

System power module

Do not use a soldering iron with transformer: If one is used, thermal fuse inside transformer will be blown

As shown above, apply soldering iron to metal parts (receptacle) inside the sleeve corresponding to P1 and N1 terminals of system power module: Do this with smoothing capacitors kept connected. By removing red/gray lead wire from diode stack, power supply can be shut off. (corresponding to ⊕ and ⊖ terminals of system power module)

RAC-25NPA, RAC-35NPA

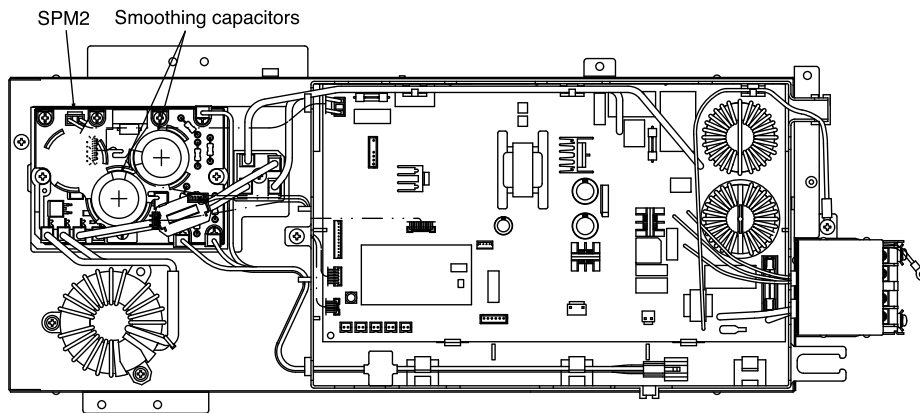

RAC-50NPA

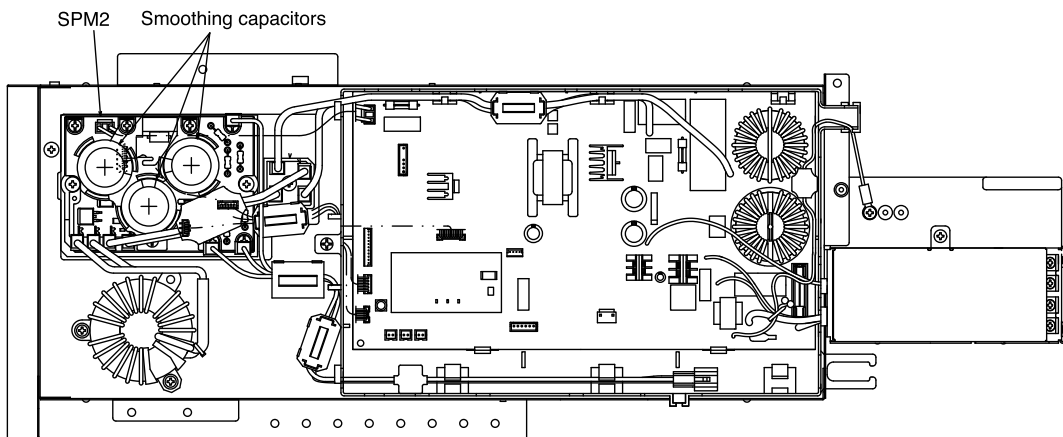

TROUBLESHOOTING WHEN TIMER LAMP BLINKS

Model RAD-18RPA, RAD-25RPA, RAD-35RPA, RAD-50RPA

Perform troubleshooting according to the number of times the indoor timer lamp and outdoor LD301 blink.

SELF-DIAGNOSIS LIGHTING MODE

Model: RAD-18RPA, RAD-25RPA, RAD-35RPA, RAD-50RPA

<Remark>

If using wired remote controller, electrical cover have to be opened so that timer lamp at indoor p.w.b can be seen as Fig. 1.

If using wireless remote controller (optional part), no need to open electrical cover. Refer the timer lamp at panel-as (Fig. 2).

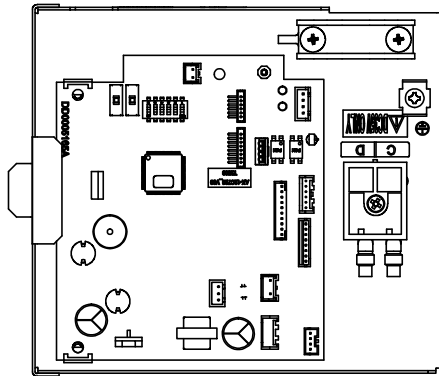

Fig. 1

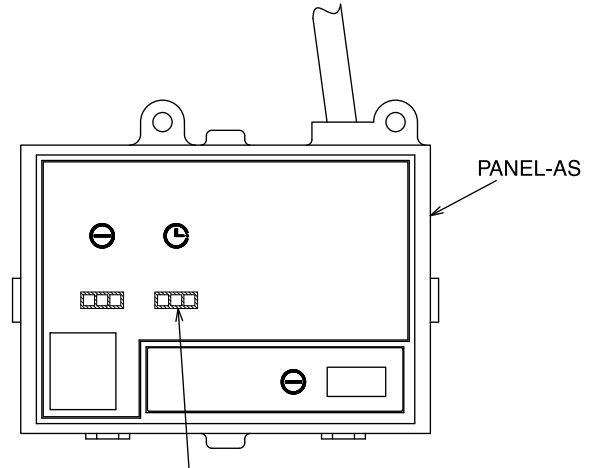

Fig. 2

No.	Timer indicator flashing mode	Reason for display	Section of estimated fault
1	Once	Refrigerant cycle abnormal The room heat exchange temperature is low during heating, or it is high during cooling.	(1) Four-way valve faulty. (2) Disconnection in heat exchange thermistor (only during heating)
2	Twice	Outdoor unit forced operation The outdoor unit is in forced operation or undergoing balancing after forced operation.	Service SW in outdoor electrical parts turned ON.
3	3 times	Indoor/outdoor interface faulty The interface signal from the outdoor unit has been interrupted.	(1) Indoor interface circuit (2) Outdoor interface circuit
4	4 times	Outdoor electrical assembly defective.	Please check at the outdoor electrical led lamp blinking (LD301) and refer to self diagnosis lighting mode for outdoor unit.
5	6 times	Abnormal water level detection All stop when the float switch has been activated.	(1) Drain stopped up (2) Drain pump (3) Float switch
6	7 times	Drain pump forced operation. When the knob of drain pump test switch at Indoor P.W.B main slide to 'test' position.	(1) Indoor P.W.B. Main.
7	9 times	Room thermistor or heat exchanger thermistor is faulty When room thermistor or heat exchanger thermistor is opened circuit or short circuit.	(1) Room thermistor (2) Heat exchanger thermistor
8	10 times	DC fan motor overcurrent detection Overcurrent in indoor DC fan motor has been detected.	(1) Indoor fan locked (2) Indoor fan motor (3) Indoor P.W.B. Main
※1 9	13 times	IC401 data reading fault There was error in the data read from IC401	IC401 faulty

(-- Lights for 0.35 sec. at interval of 0.35 sec..)

<Cautions>

- (1) If the interface circuit is faulty when power is supplied, the self-diagnosis display will not be displayed.
- (2) If the indoor unit does not operate at all, check to see if the connecting cable is connected or disconnected.
- (3) To check operation again when the timer lamp is blinking, you can use the remote control for operation (except for mode mark ※1).

SELF-DIAGNOSIS LIGHTING MODE

MODEL: RAC-25NPA, RAC-35NPA, RAC-50NPA



DANGER (DC360V)

- SWITCH OFF MAIN POWER SUPPLY TO THE OUTDOOR UNIT AT LEAST 10 MINUTES BEFORE START THE SERVICING WORK.
- MAKE SURE THE DC VOLTAGE LEVEL AT MEASURING POSITION (P1) AND (N1) IS LESS THAN 10V.
- DO NOT TOUCH THE SCREWS OF THE SYSTEM POWER MODULE WHEN THE UNIT IS TURNED ON. HIGH VOLTAGE STILL REMAIN EVEN AFTER THE UNIT IS TURNED OFF.
- DO NOT TOUCH ANY OTHER PARTS EXCEPT THE SERVICE SWITCH WHEN SERVICE OPERATION IS CONDUCTED.

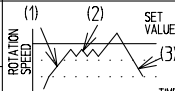
LD300	LD301	LD302	SELF-DIAGNOSIS NAME	DETAILS	MAIN CHECK POINT
<input type="checkbox"/>	<input type="checkbox"/>	<input type="checkbox"/>	[1] DURING OPERATION	LD303 LIGHTS. <input checked="" type="checkbox"/>	
<input type="checkbox"/>	<input type="checkbox"/>	<input type="checkbox"/>	NORMAL OPERATION	COMPRESSOR OPERATION	NOT MALFUNCTION
<input checked="" type="checkbox"/>	<input type="checkbox"/>	<input type="checkbox"/>	OVERLOAD (1)		THIS SHOWS AN OVERLOAD, NOT MALFUNCTION.
<input type="checkbox"/>	<input checked="" type="checkbox"/>	<input type="checkbox"/>	OVERLOAD (2)		
<input type="checkbox"/>	<input type="checkbox"/>	<input checked="" type="checkbox"/>	OVERLOAD (3)		

LD300	LD301	LD302	[2] DURING STOP	LD303 GOES OFF. <input type="checkbox"/>	
<input type="checkbox"/>	<input type="checkbox"/>	<input type="checkbox"/>	NORMAL STOP	INDOOR THERMOSTAT OFF. MAIN OPERATION OFF.	NOT MALFUNCTION.
<input checked="" type="checkbox"/>	<input type="checkbox"/>	<input type="checkbox"/>	RESET STOP	WHEN STOPPED WITH POWER RESET, NORMAL WHEN POWER HAS BEEN TURNED ON.	① P.W.B.s (POWER CIRCUIT, HIC, ETC.)
<input checked="" type="checkbox"/>	<input type="checkbox"/>	<input type="checkbox"/>	PEAK CURRENT CUT	OVER CURRENT IS DETECTED.	① SYSTEM POWER MODULE ② COMPRESSOR ③ P.W.B.s
<input checked="" type="checkbox"/>	<input type="checkbox"/>	<input type="checkbox"/>	ABNORMAL LOW SPEED ROTATION	POSITION DETECTION SIGNAL IS NOT INPUT DURING OPERATION.	① SYSTEM POWER MODULE ② COMPRESSOR ③ P.W.B.s
<input checked="" type="checkbox"/>	<input type="checkbox"/>	<input type="checkbox"/>	SWITCHING FAILURE	FAIL TO SWITCH FROM INITIAL LOW FREQUENCY SYNC. TO POSITION DETECTION SYNC. .	① SYSTEM POWER MODULE ② COMPRESSOR ③ P.W.B.s
<input checked="" type="checkbox"/>	<input type="checkbox"/>	<input type="checkbox"/>	OVERLOAD LOWER LIMIT CUT	OVERLOAD CONDITION STILL PERSISTING EVEN WHEN ROTATION SPEED IS BELOW THE LOWER RPM LIMIT.	① OUTDOOR UNIT IS EXPOSED TO DIRECT SUNLIGHT OR ITS AIRFLOW BLOCKED. ② FAN MOTOR ③ FAN MOTOR CIRCUIT ④ THE VOLTAGE IS EXTREMELY LOW.
<input checked="" type="checkbox"/>	<input type="checkbox"/>	<input type="checkbox"/>	OH THERMISTOR TEMP. RISE	OH THERMISTOR IS OPERATING.	① LEAK OF REFRIGERANT ② COMPRESSOR ③ OH THERMISTOR CIRCUIT ④ FAN MOTOR ⑤ FAN MOTOR CIRCUIT
<input checked="" type="checkbox"/>	<input type="checkbox"/>	<input type="checkbox"/>	ABNORMAL THERMISTOR	THERMISTOR IS OPENED OR SHORTED.	① THERMISTOR ② CONNECTION OF THERMISTOR IS FAULTY ③ THERMISTOR CIRCUIT
<input checked="" type="checkbox"/>	<input type="checkbox"/>	<input type="checkbox"/>	ACCELERATION DEFECTIVE	NO ACCELERATION ABOVE THE LOWER LIMIT OF THE ROTATION SPEED.	① LEAK OF REFRIGERANT ② COMPRESSOR
<input checked="" type="checkbox"/>	<input type="checkbox"/>	<input type="checkbox"/>	COMMUNICATION ERROR	COMMUNICATION BETWEEN INDOOR UNIT AND OUTDOOR UNIT ARE INTERRUPTED.	① C/D CABLE IS REVERSED ② CABLE IS DISCONNECTED ③ INTERFACE CIRCUIT OF INDOOR AND OR OUTDOOR UNIT
<input checked="" type="checkbox"/>	<input type="checkbox"/>	<input type="checkbox"/>	POWER SUPPLY VOLTAGE ERROR	POWER SUPPLY VOLTAGE IS INCORRECT.	① POWER SUPPLY VOLTAGE ② RECEPTACLE OF WIRE AT SYSTEM POWER MODULE IS NOT PROPERLY INSERTED
<input checked="" type="checkbox"/>	<input type="checkbox"/>	<input type="checkbox"/>	FAN LOCK ERROR	OUTDOOR FAN RPM IS NOT ROTATE AS INTENDED RPM.	① FAN MOTOR ② FAN MOTOR CIRCUIT
<input checked="" type="checkbox"/>	<input type="checkbox"/>	<input type="checkbox"/>	EEPROM READING ERROR	MICROCOMPUTER CANNOT READ THE DATA IN EEPROM.	① HIC
<input checked="" type="checkbox"/>	<input type="checkbox"/>	<input type="checkbox"/>	ACTIVE CONVERTER DEFECTIVE	OVER VOLTAGE IS DETECTED BY SYSTEM POWER MODULE.	① SYSTEM POWER MODULE

* EXAMPLE OF BLINKING (5 TIMES) 2SEC (••• LIGHTS FOR 0.25 SEC. AT INTERVAL OF 0.25 SEC.)

WIRING DIAGRAM

BLK : BLACK GRY : GRAY
 BLU : BLUE RED : RED
 BRN : BROWN WHT : WHITE
 GRN : GREEN YEL : YELLOW

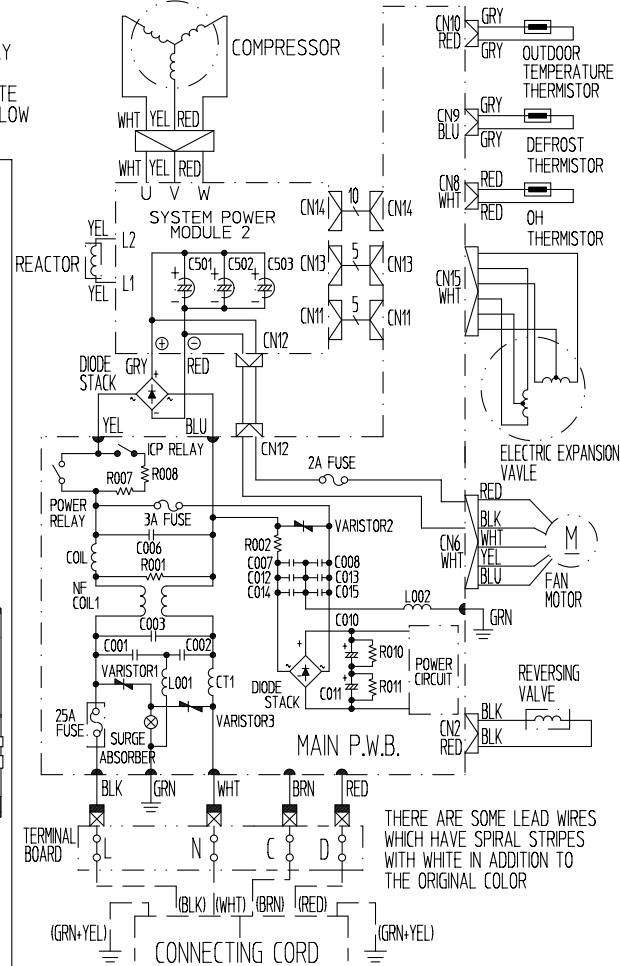

SERVICE OPERATION

COLLECT REFRIGERANT FROM INDOOR UNIT AND STORE AT OUTDOOR UNIT.

1. SWITCH OFF THE MAIN POWER SUPPLY AND THEN SWITCH IT ON AGAIN. WAIT FOR 1 MINUTE.
2. PRESS AND HOLD THE SERVICE SWITCH FOR 1 SECOND TO START OUTDOOR UNIT IN COOLING OPERATION. IN ORDER TO PREVENT PARTS FROM DAMAGE, DO NOT OPERATE THE OUTDOOR UNIT FOR MORE THAN 5 MINUTES.
3. PRESS AND HOLD THE SERVICE SWITCH FOR 1 SECOND TO STOP THE SERVICE OPERATION.
4. REPEAT STEP 1 TO 3 IF SERVICE OPERATION NEED TO BE REPEATED.

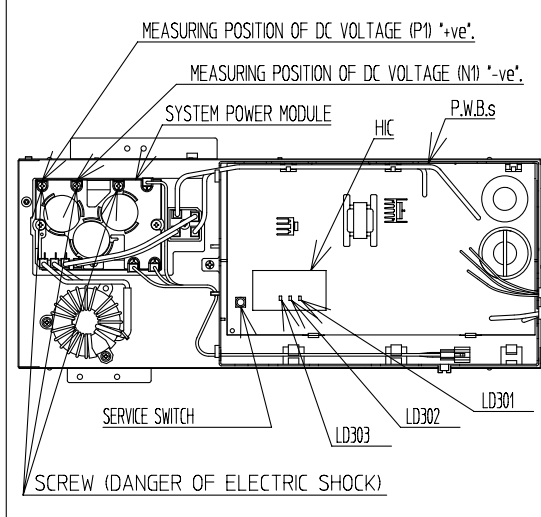

MEASURING POSITION OF DC VOLTAGE (P1) '+ve'.

MEASURING POSITION OF DC VOLTAGE (N1) '-ve'.

SYSTEM POWER MODULE HIC P.W.B.s

SERVICE SWITCH LD303 LD302 LD301

SCREW (DANGER OF ELECTRIC SHOCK)

TERMINAL BOARD (GRN+YEL) (BLK) (WHT) (BRN) (RED) (GRN+YEL)



CONNECTING CORD

SELF-DIAGNOSIS MEMORY FUNCTION





Failure modes are stored in the nonvolatile memory of indoor unit and shall be redisplayed by remote controller.



This function is useful in checking the failure modes either during switching OFF the power or restarting the device without checking the number of indication lamp blinking. Remote controller can redisplay up to last 5 failure modes from the memory. However, failure modes which are rarely to occur are also stored in the memory which caused the numbers of failure more than 5. Thus, for some failure modes which are unable to retrieve because of remote controller limit to redisplay only 5 failure modes, it can be found by clearing up the memory first then recheck the memory content again during the visit at the customer place.

< How to redisplay failure diagnosis >



1. Turn the circuit breaker OFF.
2. Set the remote controller to OFF condition, indicated by **OFF** on the display.
3. By pressing  (MODE) button on the remote controller, set to Cooling operation indicated by  (COOL).
4. Turn the circuit breaker ON.
5. Set the room temperature setting on the remote controller to 32°C by pressing the (TEMP \downarrow or \uparrow) button.
6. Set the fan speed with the  (FAN SPEED) button according to the desired failure information. (Refer to the corresponding table below)

Fan speed settings for failure data

Fan Speed	Data
AUTO 	Newest
HI 	Second newest
MED 	Third newest
LOW 	Fourth newest
SILENT 	Oldest

7. While directing the remote controller towards the receiver of the indoor unit, press (TEMP \uparrow) button and  (START/STOP) button simultaneously. (The remote controller perform signal transmission with the device.)
8. The device beeps [Pi-] to indicate that it has just received the signal to redisplay the failure mode.
9. Direct the remote controller towards the receiver of indoor unit (within 2 meters in front of indoor unit) and press the  (INFO) button. Wait for 2 seconds for signal transmission. An error code will be displayed on the remote controller display.

< How to clear the troubleshooting data >

1. Redisplay the troubleshooting status. (See the above procedure.)
2. Turn the circuit breaker OFF.
3. By pressing  (MODE) button on the remote controller, set to Heating operation indicated by  (HEAT).
4. Turn the circuit breaker ON.
5. Set the room temperature setting on the remote controller to 16°C by pressing the (TEMP \downarrow or \uparrow) button.
6. While directing the remote controller towards the receiver of the indoor unit, press (TEMP \downarrow) button and  (START/STOP) button simultaneously. (The remote controller perform signal transmission with the device.)
7. The product beeps for a second [Pi-] to indicated that it has just received the signal. The data has now been cleared.

< How to display error code in case of failure just occurs >

If timer lamp  of the indoor unit blinking and operation stops, please perform below procedures.

1. Direct the remote controller towards the receiver of indoor unit (within 2m in front of the indoor unit) and press  (INFO) button.
2. Wait for 2 seconds for signal transmission.
3. Indication of error code will be shown on the remote controller display for 10 seconds.

For example :

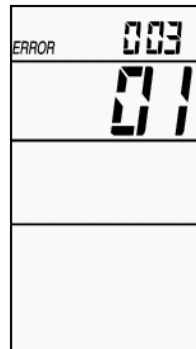
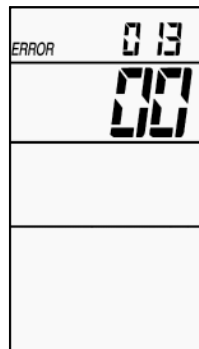

For details information regarding error code, please refer to page 128.

	TIMER LAMP BLINKING	LD301 BLINKING	CODE	MEANING	DETAILS	MAIN CHECK POINT
INDOOR	-	-	000 00	Normal		
	1 time	-	001 00	Refrigerant cycle fault	When the indoor heat exchanger temperature is too low in the heating mode or it is too high in the cooling mode.	1. Reversing valve defective 2. Heat exchanger thermistor disconnected. (only in heating mode)
	2 times	-	-	Outdoor unit is under forced operation.	It is not failure. Outdoor unit is in forced operation or balancing operation after forced operation.	1. Electrical parts in the outdoor unit.
	3 times	-	003 00	Communication error between indoor and outdoor units.	Interface signal from the outdoor unit is interrupted.	1. Indoor interface circuit 2. Outdoor interface circuit
	9 times	-	009 00	Indoor thermistor	Room thermistor or heat exchanger thermistor is opened circuit or short circuit.	1. Room thermistor 2. Heat exchanger thermistor
	10 times	-	010 00	Abnormal rotating numbers of DC fan motor	Overcurrent is detected at the DC fan motor of the indoor unit.	1. Indoor interface circuit 2. Outdoor interface circuit 3. Indoor control P.W.B
	13 times	-	013 00	IC401 data reading error	When data read from IC401 or IC402 is incorrect.	1. IC401 or IC402 abnormal
OUTDOOR	4 times	2 times	002 01	Peak current cut	Over current is detected.	1. Compressor 2. P.W.B.s
	4 times	3 times	003 01	Compressor abnormal low speed rotation	Position detection signal is not input during operation.	1. P.W.B.s 2. Compressor
	4 times	4 times	004 01	Compressor switching failure	Fail to switch from initial low frequency sync to position detection sync.	1. P.W.B.s 2. Compressor
	4 times	5 times	005 01	Overload lower limit cut	Overload condition still persisting even when rotation speed is below the lower rpm limit.	1. Outdoor unit is exposed to direct sunlight or its air flow blocked. 2. Fan motor 3. Fan motor circuit 4. The voltage is extremely low.
	-	6 times	006 01	OH thermistor temperature rise	OH thermistor is operating.	1. Leak of refrigerant 2. Compressor 3. OH thermistor circuit 4. Fan motor 5. Fan motor circuit
	4 times	7 times	007 01	Abnormal outdoor thermistor	Thermistor is opened or shorted.	1. Thermistor 2. Connection of thermistor is faulty 3. Thermistor circuit
	4 times	8 times	008 01	Acceleration defective		
	-	9 times	009 01	Communication error	When indoor unit is not connected, it blinks similarly, not malfunction.	1. Cable is wrong connected 2. Cable is open 3. Interface circuit between indoor and outdoor unit
	-	10 times	010 01	Abnormal power source	Power supply voltage is incorrect.	1. Power supply voltage 2. Receptacle of wire for P.W.BIPM is not properly inserted
	-	11 times	011 01	Fan stop for strong wind	Fan motor load is too heavy or rotation disturbed by wind blow.	1. Fan motor 2. Outdoor condition (wind)
	4 times	12 times	012 01	Fan motor fault	Outdoor fan rpm is not rotate as intended rpm.	1. Fan motor 2. Fan motor circuit
	4 times	13 times	013 01	EEPROM reading error	Microcomputer cannot read the data in EEPROM.	1. P.W.B main
	4 times	14 times	014 01	Active converter defective	Over voltage is detected, compressor abnormal load.	1. P.W.B.s 2. Compressor
	4 times	15 times	015 01	Abnormal PWB circuit	Active circuit abnormal.	1. P.W.B.s
-	16 times	016 01	Software peak current cut			

< Cautions >

This function is effective only once immediately after the power is turned on. It will not work if you have performed another remote control operation beforehand. Note also that it may not function in response to a procedure other than the above. (If it does not work, turn off the power, turn it back on and repeat the procedure.)

If the memory stores nothing, performing a redisplay operation will not blink the lamp.

For a normal operation, turn off the power and turn it back on. After the above operation, the product will not receive a remote control signal normally.

After clearing the troubleshooting data, turn off the power. (If you do not turn off the power, the product will become unresponsive to remote control signals.)

CHECKING THE INDOOR/OUTDOOR UNIT ELECTRICAL PARTS AND REFRIGERATING CYCLE

Model **RAC-25NPA**
RAC-35NPA
RAC-50NPA

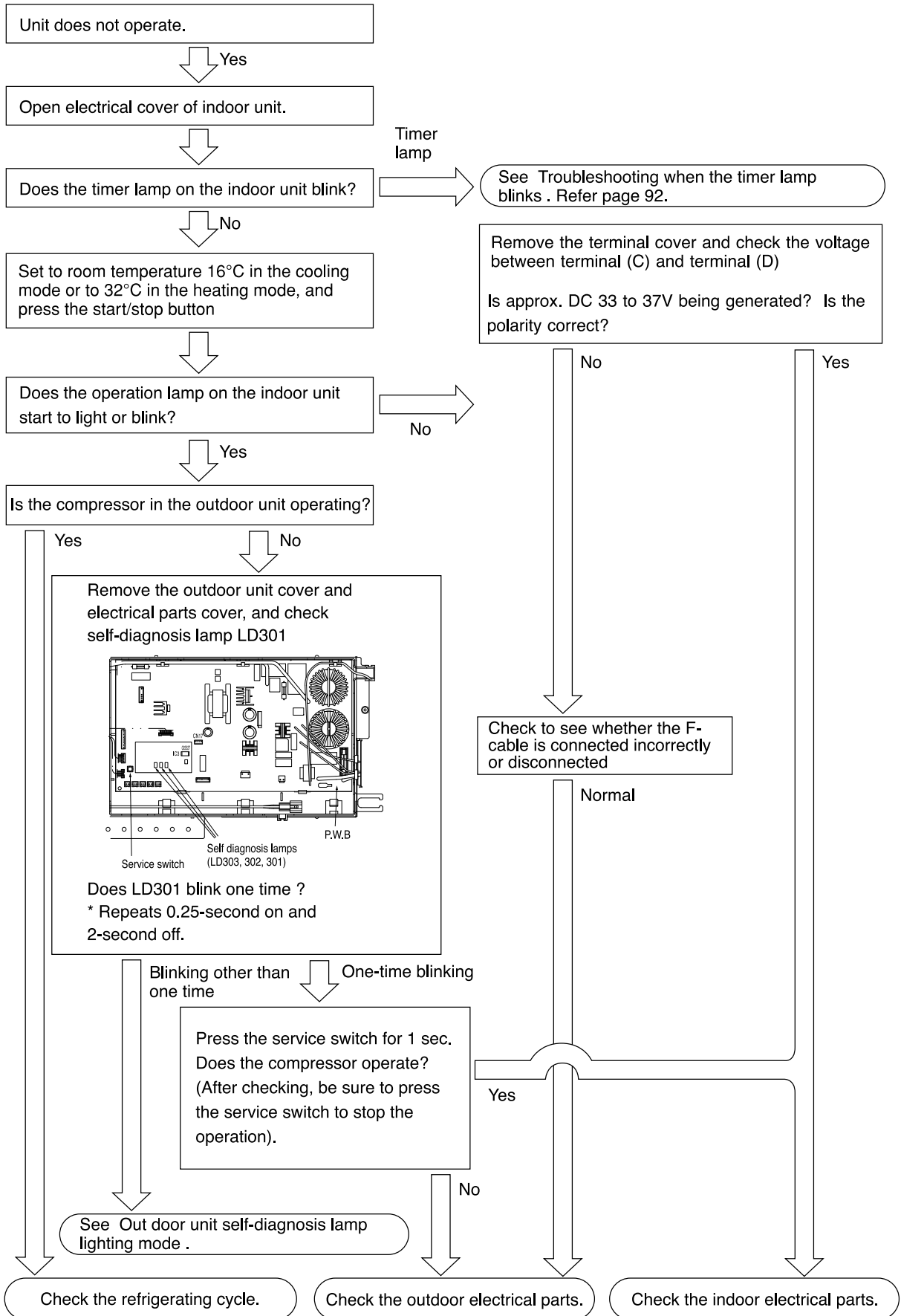

CHECKING INDOOR UNIT ELECTRICAL PARTS

1. Power does not come on (no operation)

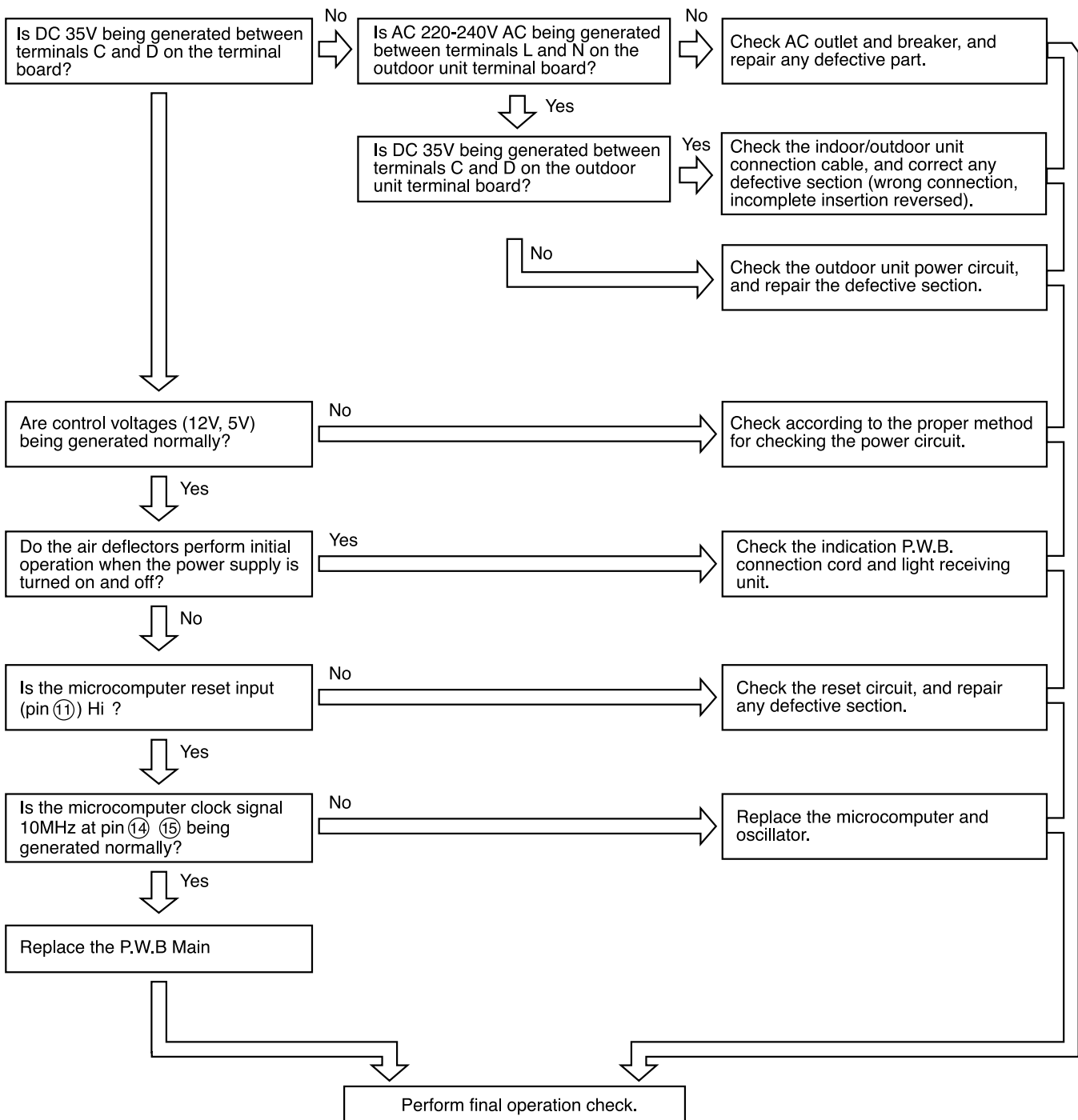

2. Outdoor unit does not operate (but receives remote infrared signal)

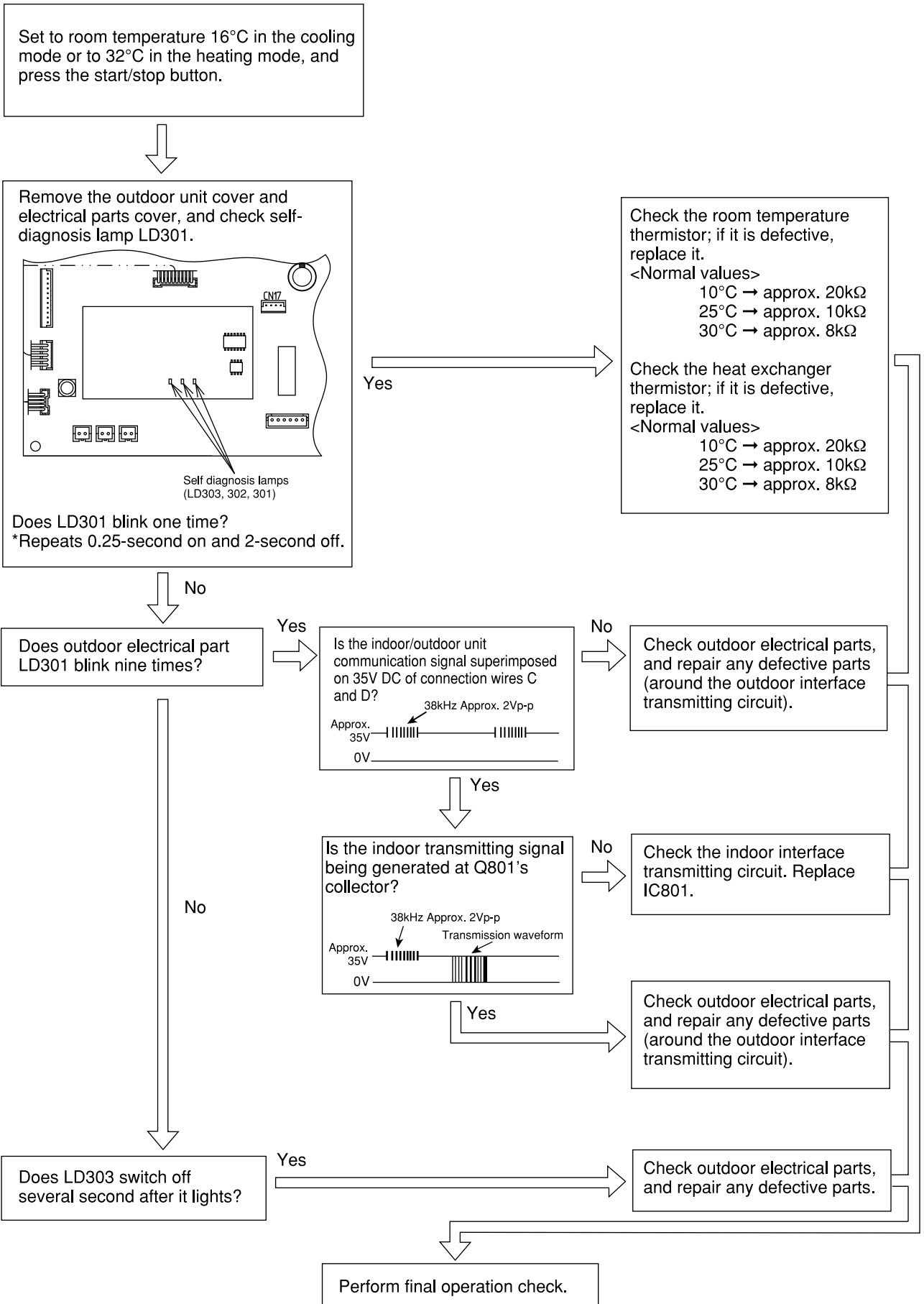

3. Only indoor fan does not operate (other is normal)

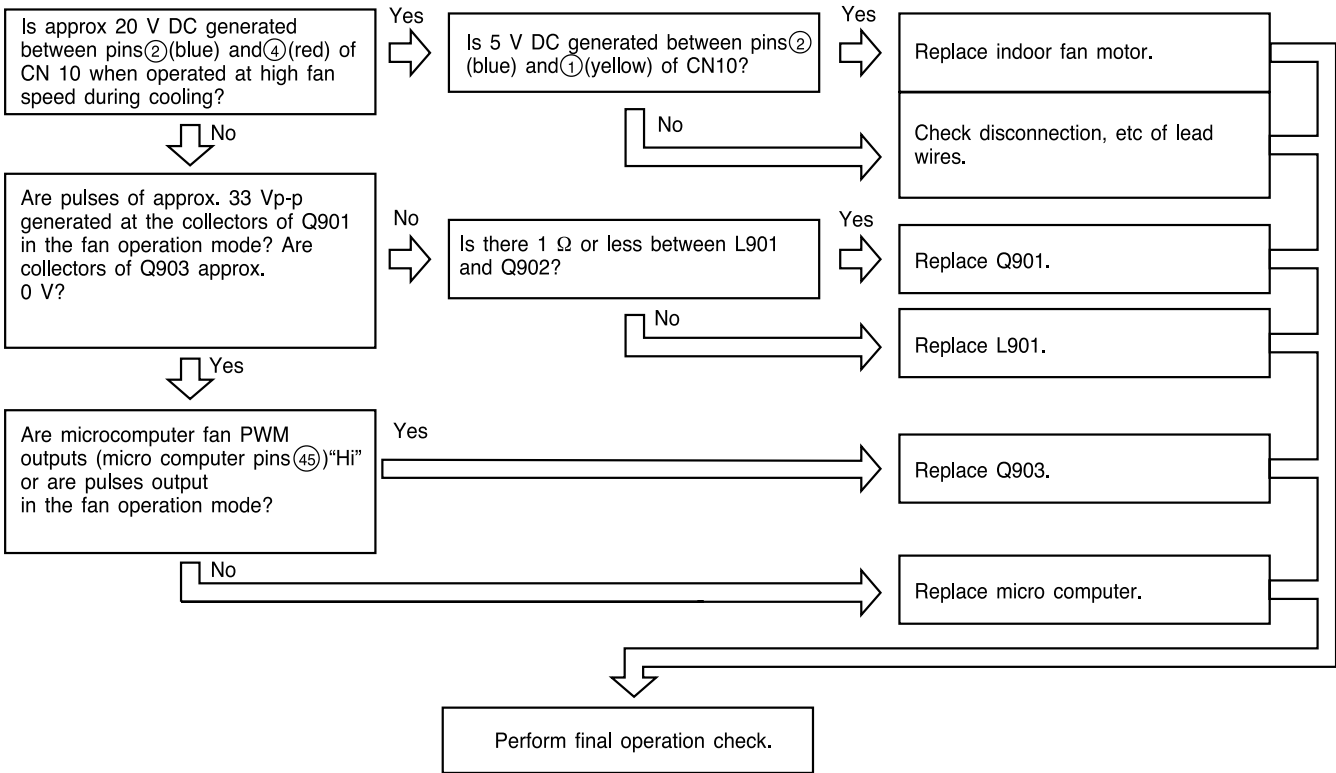

4. Indoor fan speed does not change (other is normal)

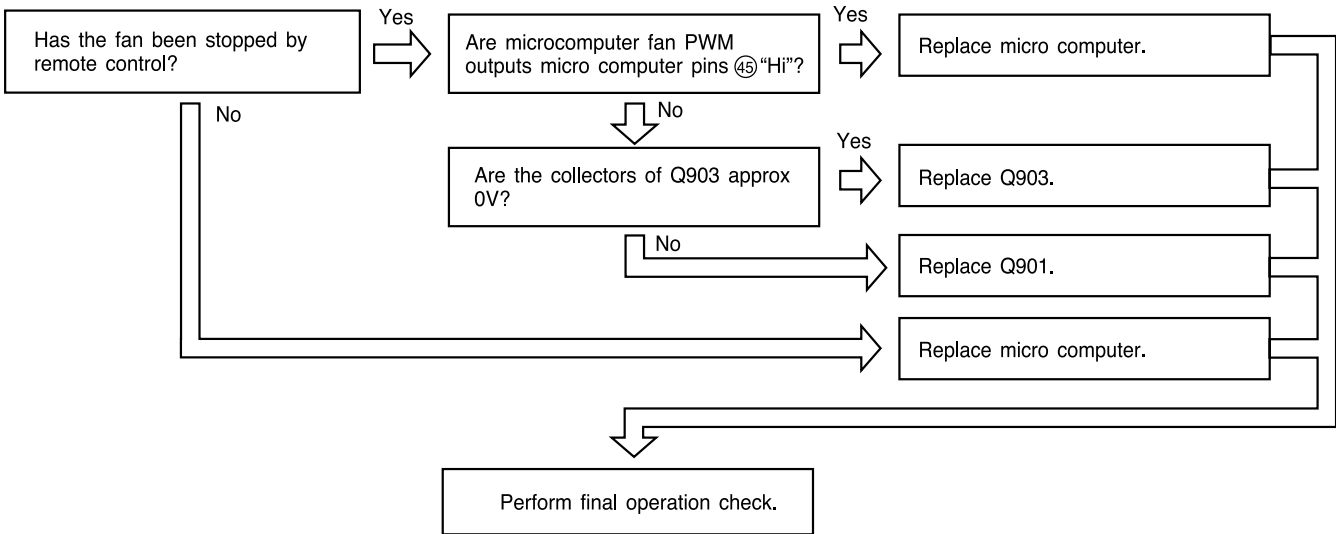

5. All systems stop from several seconds to several minutes after operation is started (all indicators are also off)

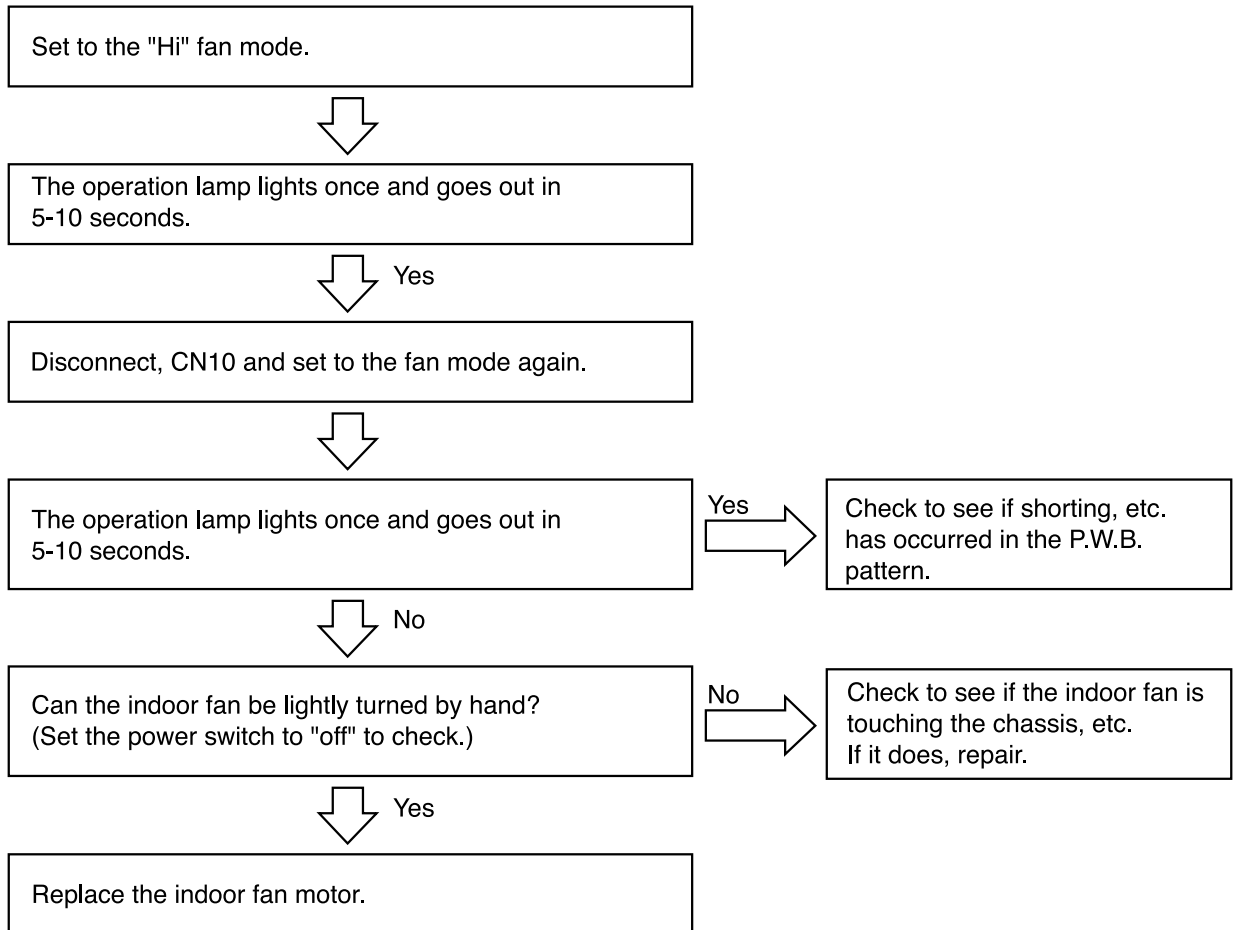

CHECKING THE OUTDOOR UNIT ELECTRICAL PARTS

MODEL RAC-25NPA, RAC-35NPA, RAC-50NPA

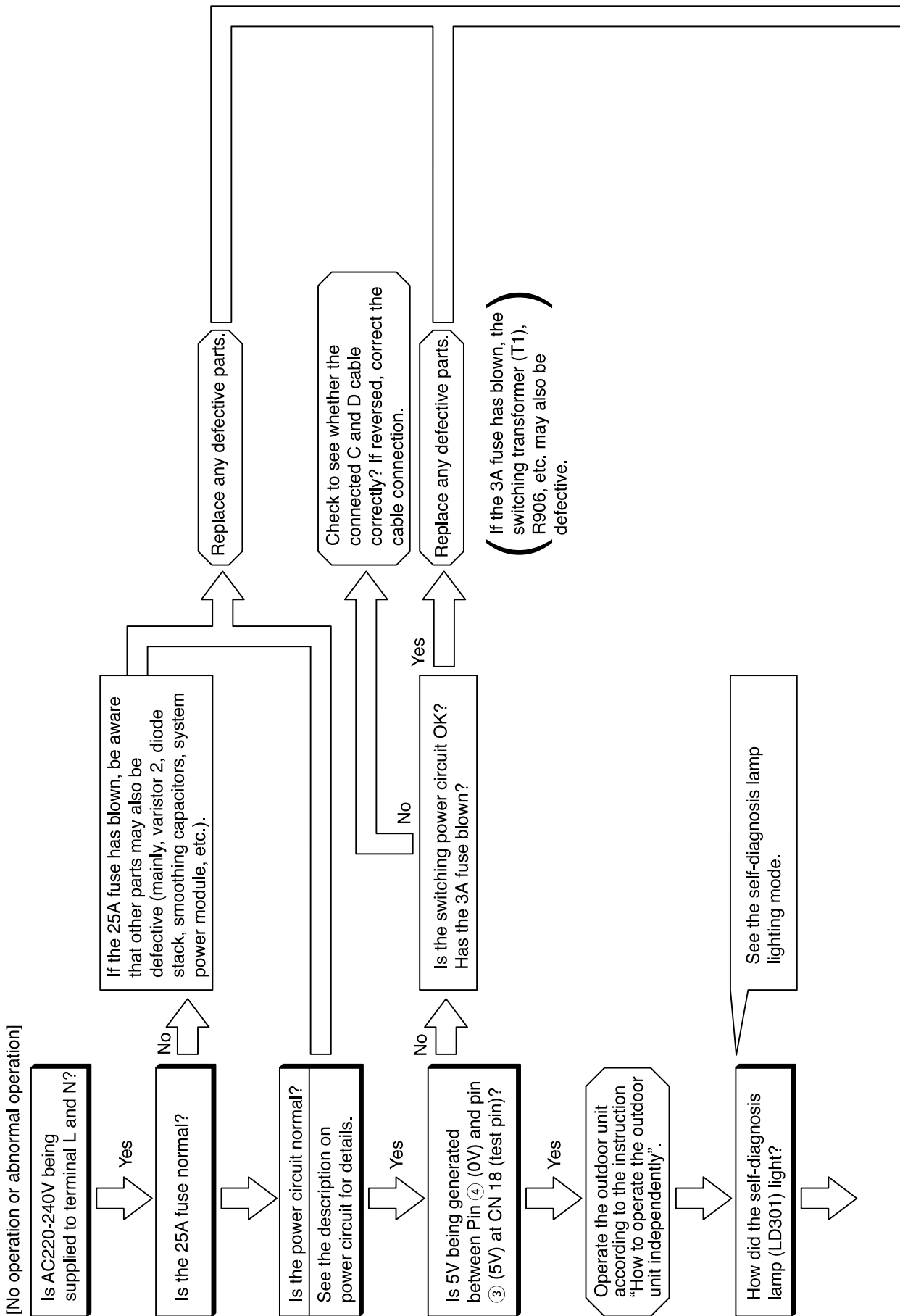

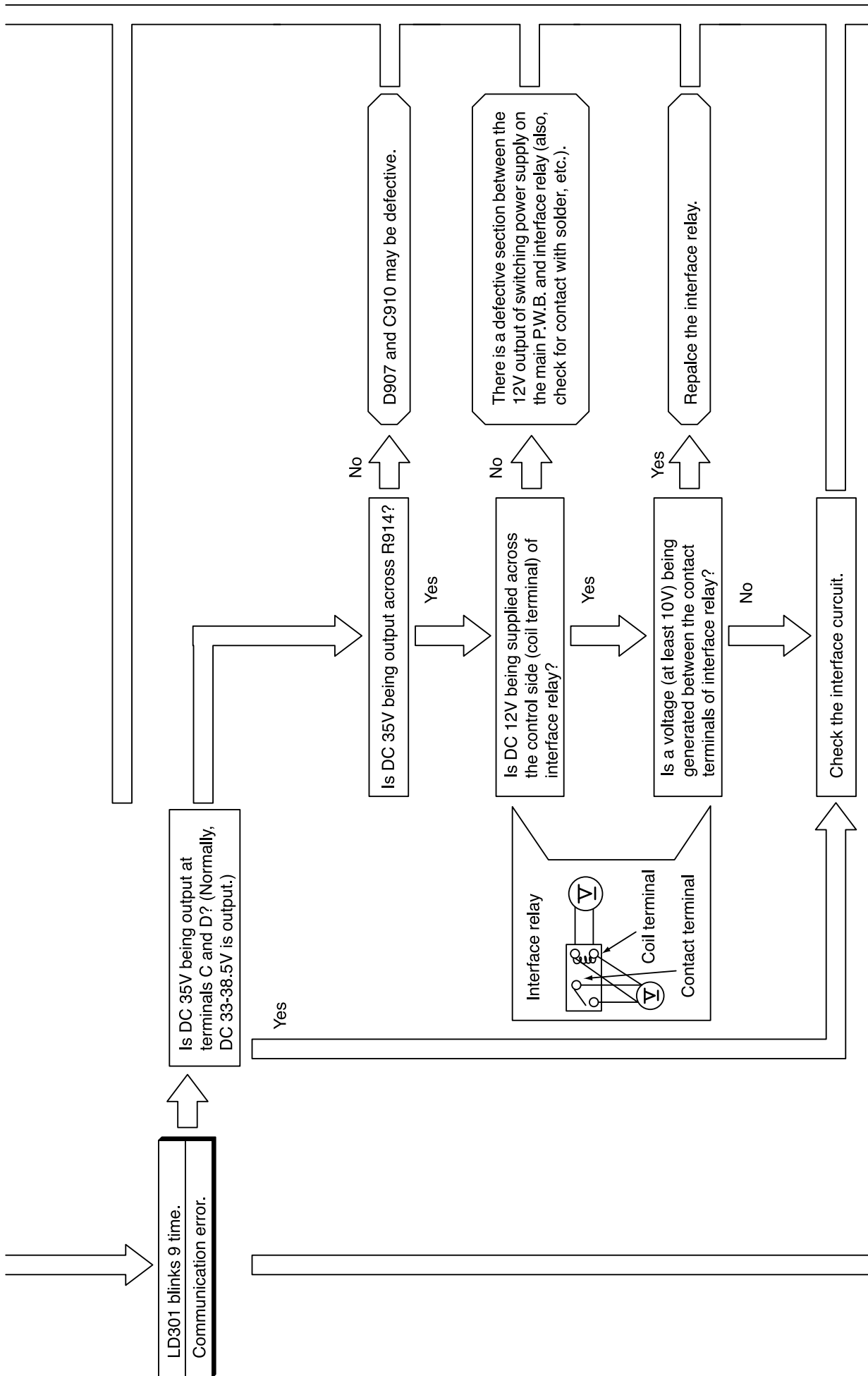

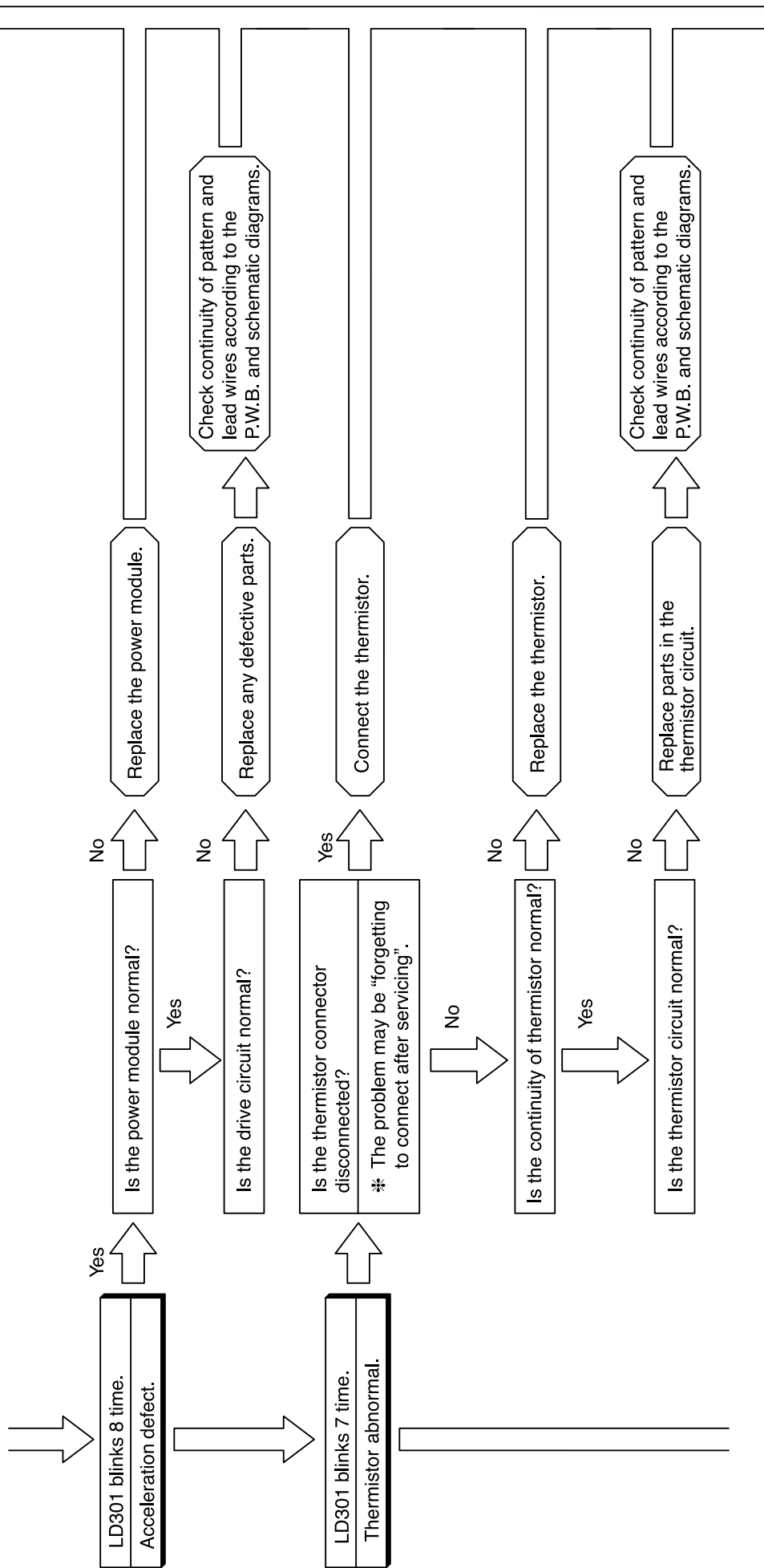

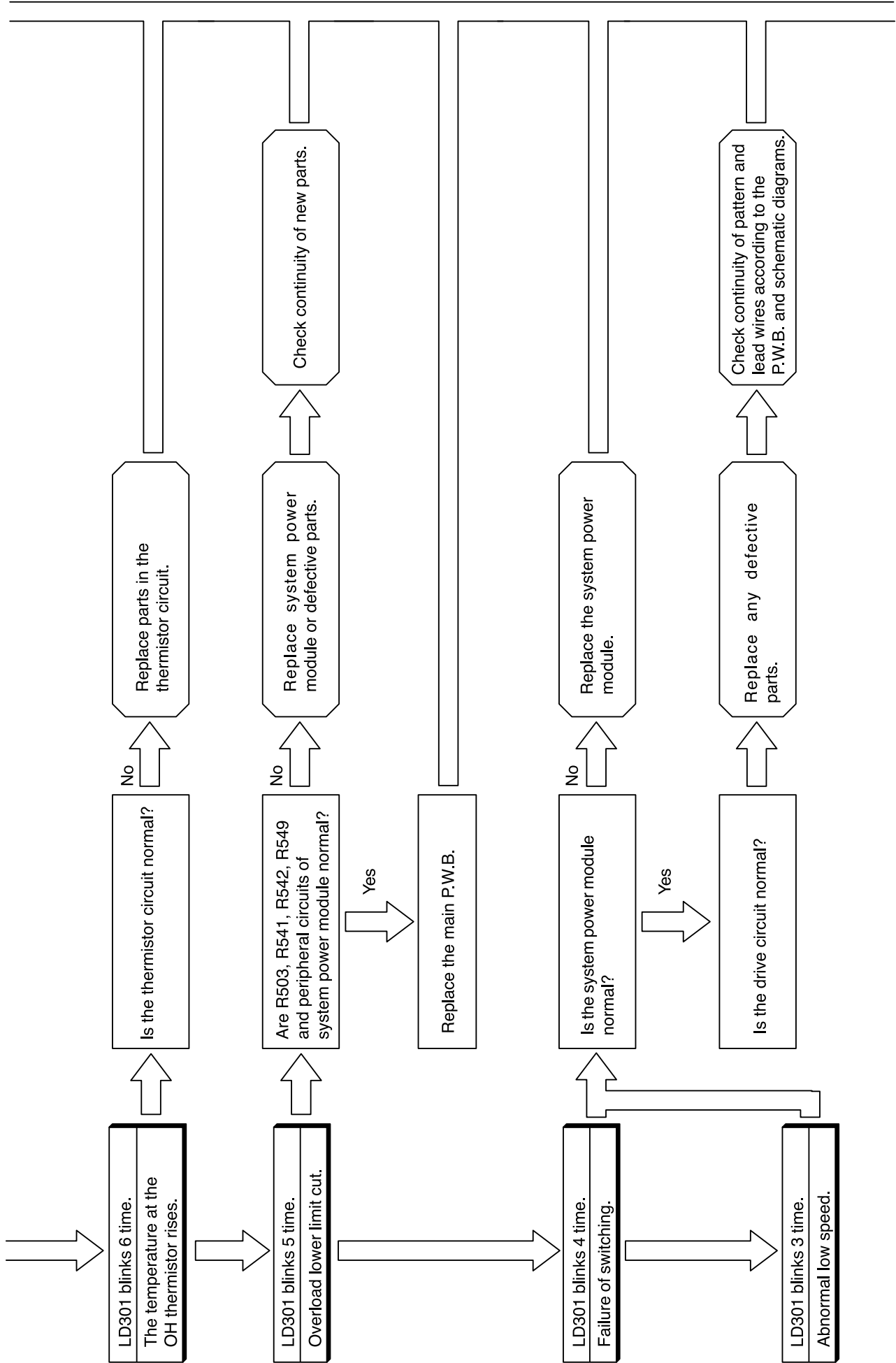

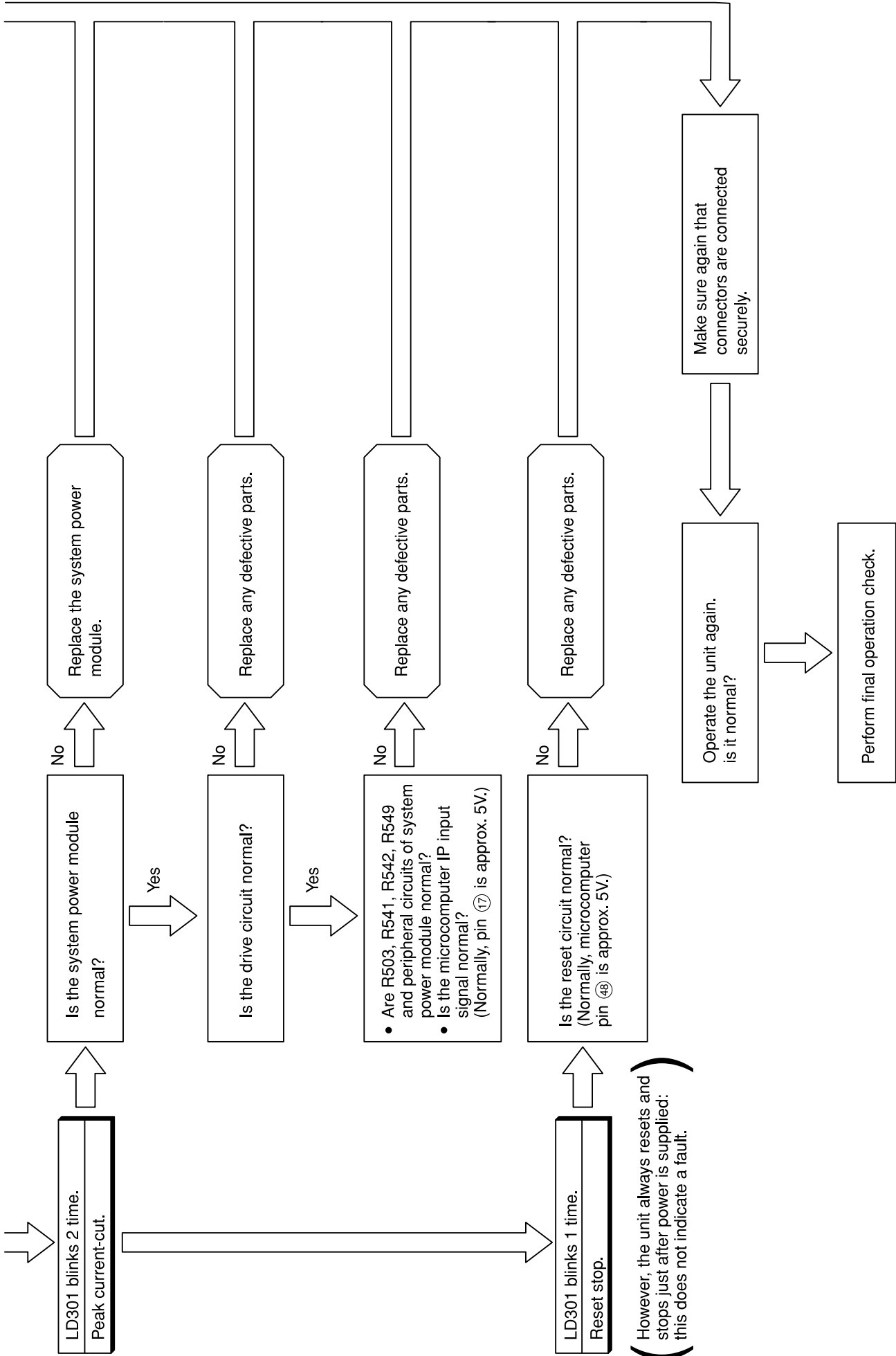

POWER CIRCUIT

Phenomenon 1 <Rotation speed does not increase>

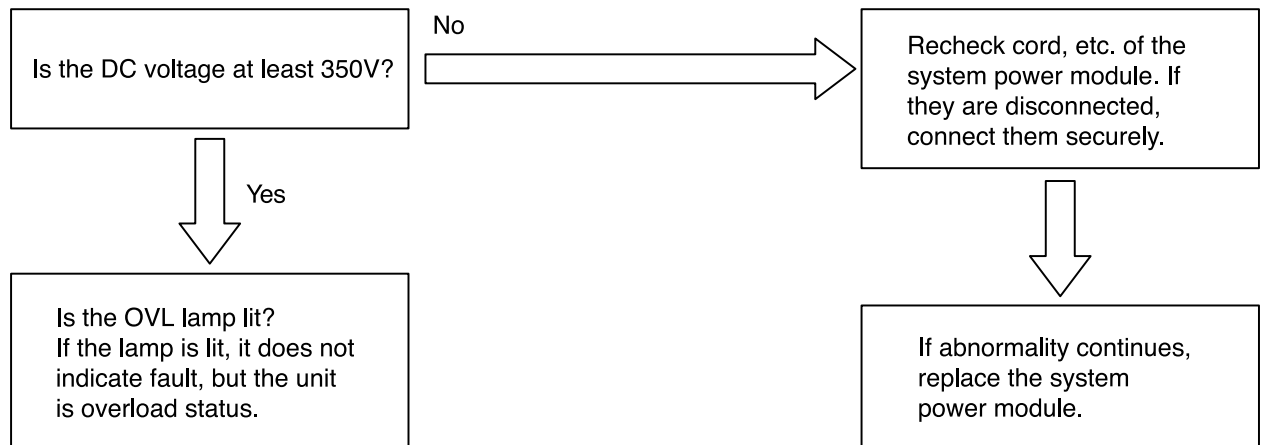

Overvoltage defect: system power module faulty (15-times blinking)

HOW TO CHANGE THE SHIFT VALUE SETTING TEMPERATURE

The shift value setting temperature for Cooling and Heating mode operation can be changed using the remote controller. (This procedure shall be implemented strictly by service personnel only.)

(For initial shift value temperature setting for Cooling mode (SHIFTC) and Heating operation mode (SHIFTW) : Please refer to page 71)

PROCEDURES

1. While pressing and holding the **⏻** (START/STOP) button and the **⏻** (ON) button, press the **RESET** [RESET] button on the same. Release the **RESET** [RESET] button only and make sure that all marks on the remote controller display are indicated, then release the **⏻** (START/STOP) button and the **⏻** [ON] button. Remote controller now enters "Shift Value Change Mode".
2. Press the **MODE** selector button so that the display indicates **FAN** mode.
3. Press the **⏻** (START/STOP) button and FAN operation will be started.
4. Set the FAN SPEED with the **FAN** (FAN SPEED) button according to the following FAN speed setting in order to choose the desired operation mode that is required for shift value setting temperature modification.
 - To change the shift value for COOLING mode operation, select either **HIGH** or **MED** FAN SPEED.
 - To change the shift value for HEATING mode operation, select either **LOW** or **SILENT** FAN SPEED.

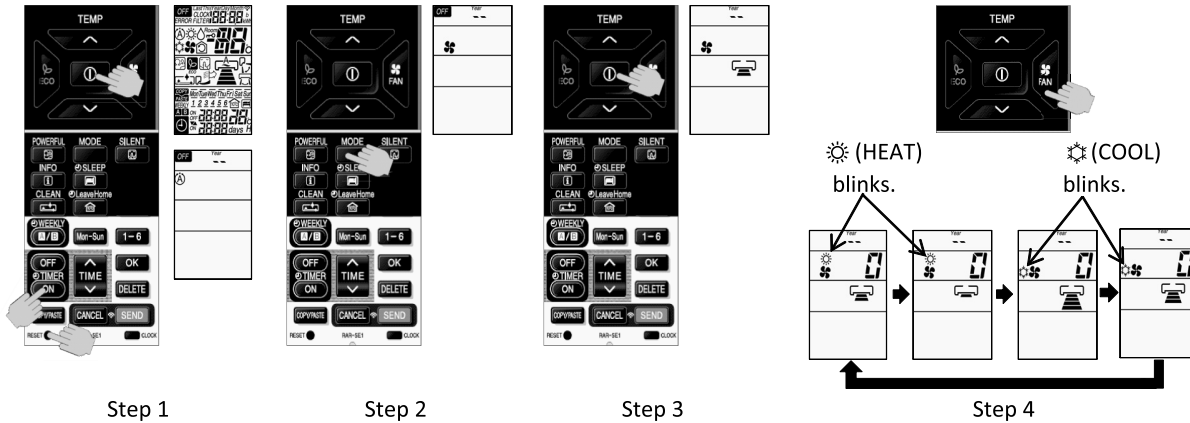

5. Press the **TEMP** (↓ or ↑) button to change the shift value. (The shift value changed with device beep sound.)

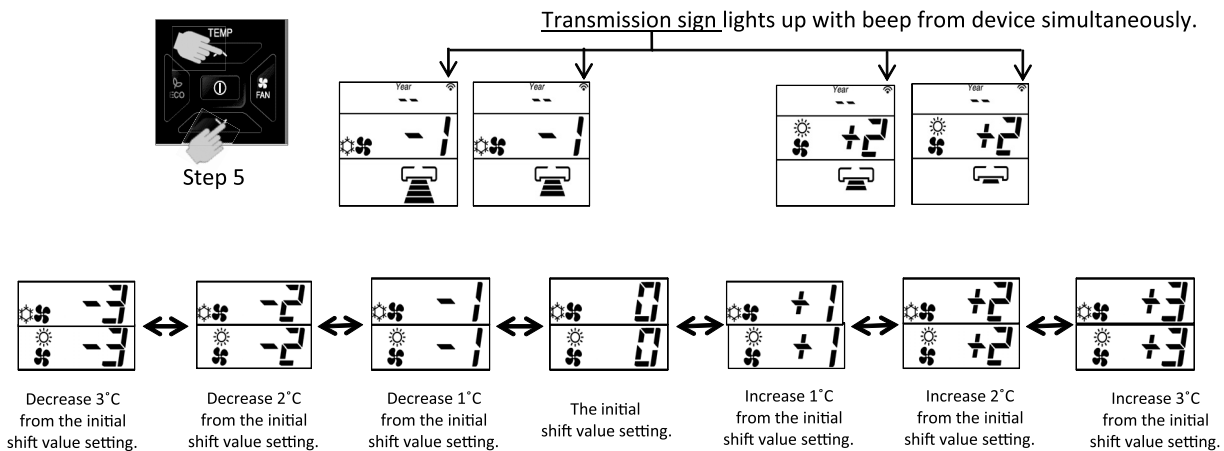

NOTE :

- (1) The displayed shift value, **HEAT** and **COOL** symbol on the remote controller display will disappear after 10 seconds.
- (2) The changed shift value will remain unchanged after turned off the power.
- (3) If "0" is displayed on the remote controller display, it indicates the shift value is now at the initial setting.

SETTING THE PREVENTION OF MUTUAL INTERFERENCE FOR REMOTE CONTROLLER

(Applicable for Remote controller model : RAR-5E1, RAR-5E2, RAR-5E3, RAR-5E4 and RAR-5E5)

Case : 2 sets of indoor units installed near to each other.

If both indoor units can receive the same remote controller signal, please set the remote controller as below. (This setting will change the signal address of each remote controller.)

Initial remote controller signal address setting is **A**.

This procedure change the remote controller signal address from **A** to **B**.

1. The circuit breaker for the other unit shall be OFF.



2. Slide the remote controller cover to take it off.

3. While directing the remote controller towards the receiver of the indoor unit, press **1-6** button, **ON** (ON TIMER) button and **RESET** (RESET) button simultaneously. (The remote controller perform signal transmission with the device.)

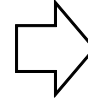
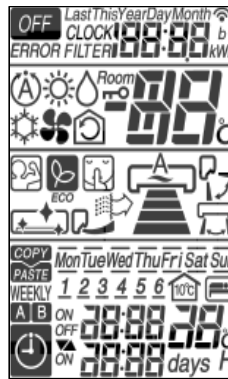
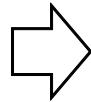

Signal transmission : From A to B

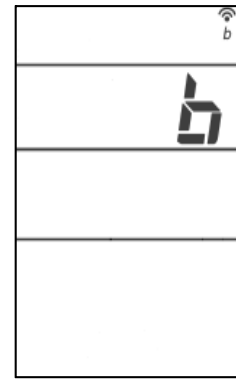

4. The indoor unit beeps [Pip] to indicate that it has just received the signal from remote controller.



5. Please check the usability of each set of indoor unit using its own remote controller.

Note : If indoor unit still not receive the correct signal from the correct remote controller, setting shall be made again.
By setting again for the 2nd time, the signal address will change from **B** to **A**. Then, it repeat again for the 3rd time, the remote controller signal address will change from **A** to **B**.

Signal transmission : From B to A

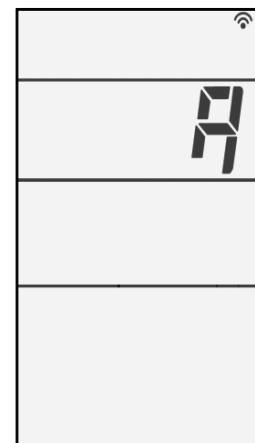







OPERATION MODE LOCK SETTING

If Dip switch position is set at "Heating mode only" or "Cooling mode only" as mentioned on page 86, it is required to set the remote controller into operation mode lock setting. Without setting the remote controller, it will caused unmatched signal transmission between indoor unit and remote controller.





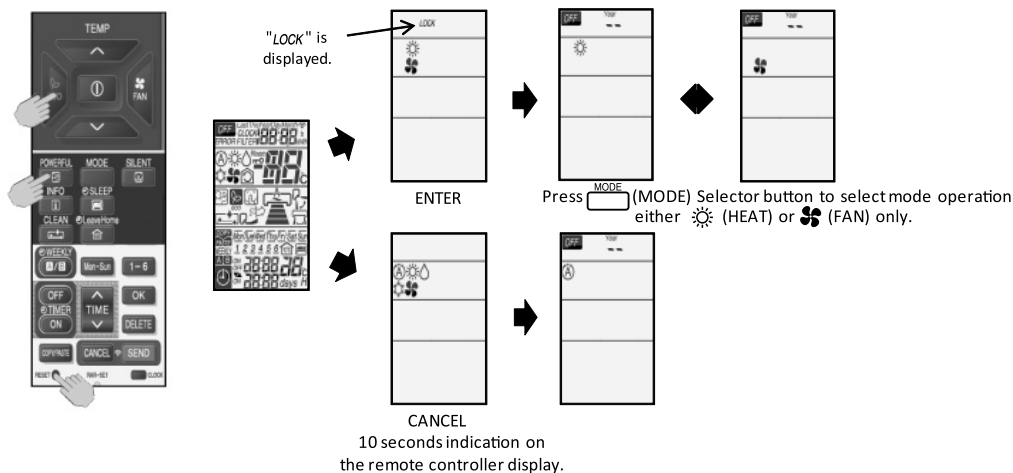

PROCEDURE

1. Heating operation mode lock setting

- (a) While pressing and holding  (ECO) button and  (POWERFUL) button, press  (RESET) button on the same time. Release  (RESET) button only and make sure that all marks on the remote controller display are indicated, then release the  (ECO) button and  (POWERFUL) button. Remote controller now enters "Heating operation mode lock".
- (b) To cancel the "Heating operation mode lock", repeat the above procedure (1(a)).





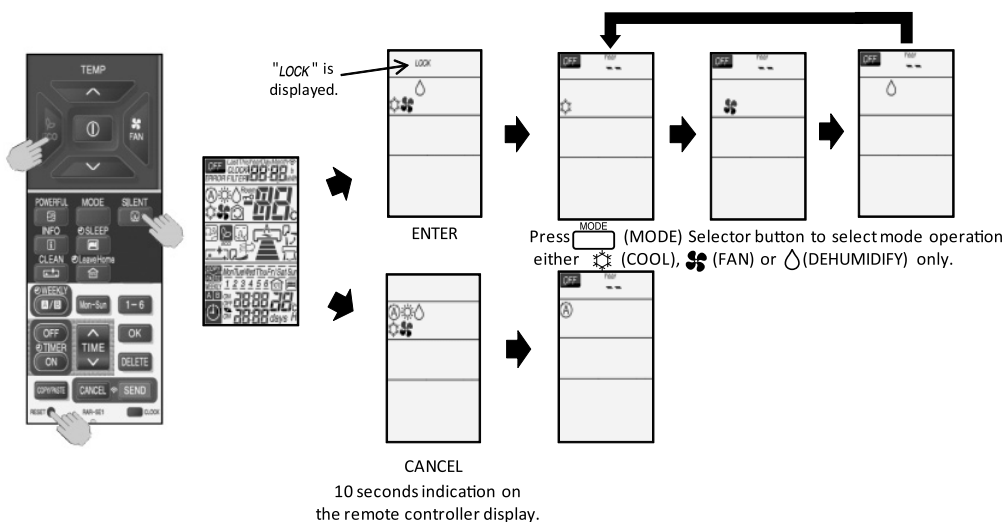

2. Cooling operation mode lock setting

- (a) While pressing and holding  (ECO) button and  (SILENT) button, press  (RESET) button on the same time. Release  (RESET) button only and make sure that all marks on the remote controller display are indicated, then release the  (ECO) button and  (SILENT) button. Remote controller now enters "Cooling operation mode lock".
- (b) To cancel the "Cooling operation mode lock", repeat the above procedure (2(a)).











NOTE :

- (1) The indication of " LOCK " and (" , " , "  " or "  ") mode operation symbol on the remote controller display will disappear after 10 seconds and it will enters to OFF condition indicated by  on the display.
- (2) The OPERATION MODE LOCK setting will remain in the remote controller memory eventhough the remote controller is ran out of battery.



DISPLAY OPERATION MODE SETTING

For operating indoor unit independently (without outdoor unit connection), remote controller has to be set according to below procedures before send the signal to the indoor unit. New communication format between indoor and outdoor is required to communicate with outdoor unit.

PROCEDURE

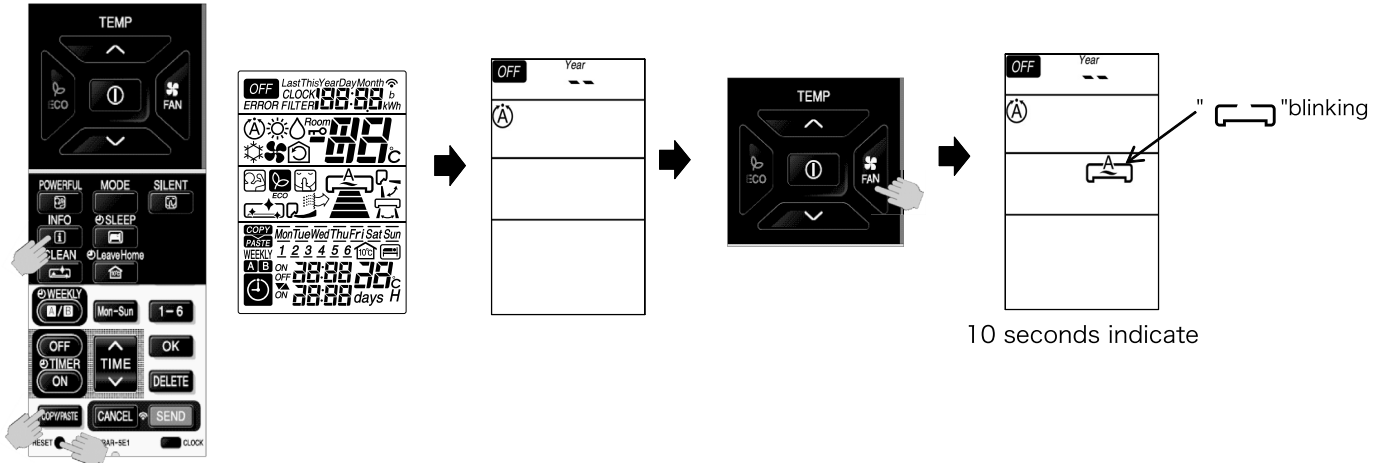
- While pressing and holding  (INFO) button and  (COPY/PASTE) button, press  (RESET) button on the same time. Release  (RESET) button only and make sure that all marks on the LCD display are indicated, then release the  (INFO) button and  (COPY/PASTE) button. Remote controller now enters "DISPLAY OPERATION MODE" for the indoor unit to run independently. Please ensure that when pressing  (FAN) button, "" will blinking.



- Press the  (MODE) selector button to choose the desired operation mode.
- Press  (START/STOP) button. Then, the indoor unit will starts to operate independently accoring the selected operation mode.

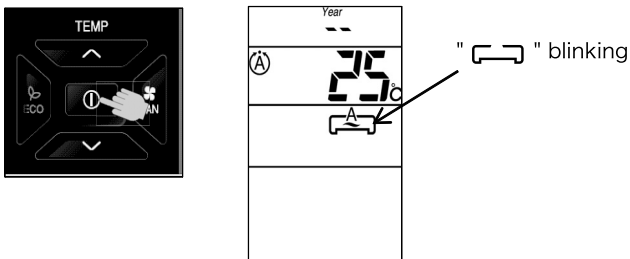

NOTE :

- (1) During "DISPLAY OPERATION MODE", "" blinks on LCD of remote controller.
- (2) When operation stops, "DISPLAY OPERATION MODE" is canceled.

CHECKING THE REFRIGERATING CYCLE

(JUDGING BETWEEN GAS LEAKAGE AND COMPRESSOR DEFECTIVE)

1. Troubleshooting procedure (No operation, No heating, No cooling)

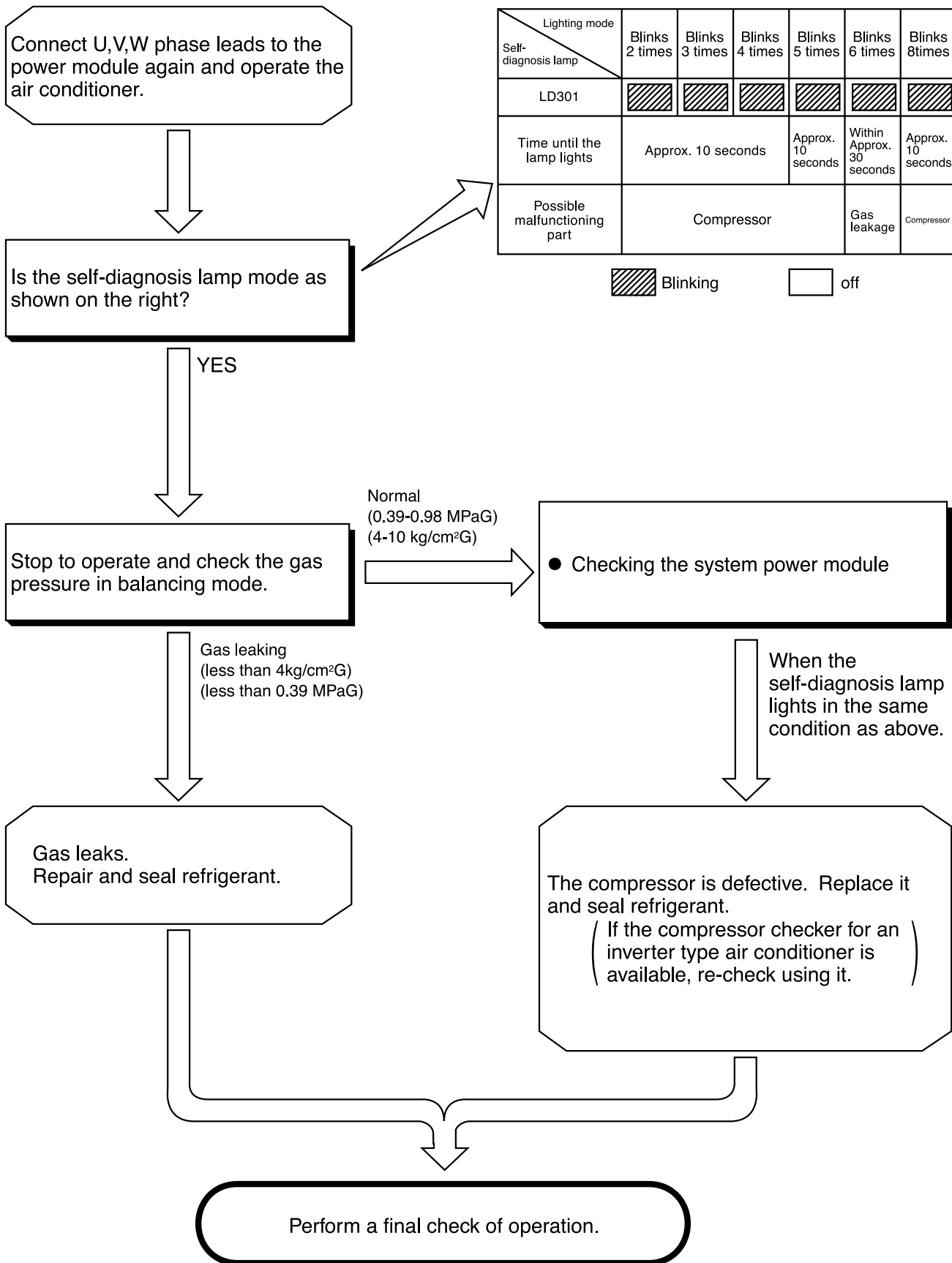

HOW TO OPERATE USING THE SERVICE SWITCH THE OUTDOOR UNIT

MODEL RAC-25NPA, RAC-35NPA, RAC-50NPA

1. Turn off the power supply to outdoor unit and then turn on again.
2. Remove the electrical box cover.

LD303 (red) will light and the unit will operate in the forced cooling mode at this time.

Never operate the unit for more than 5 minutes.

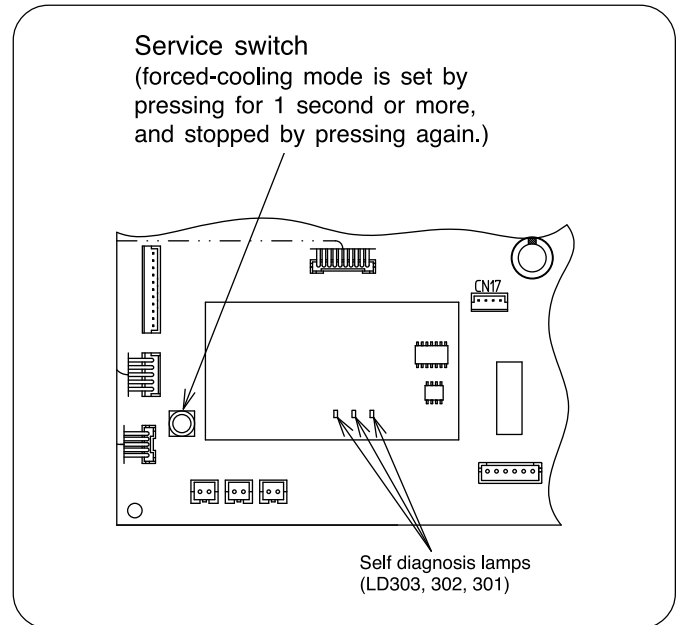
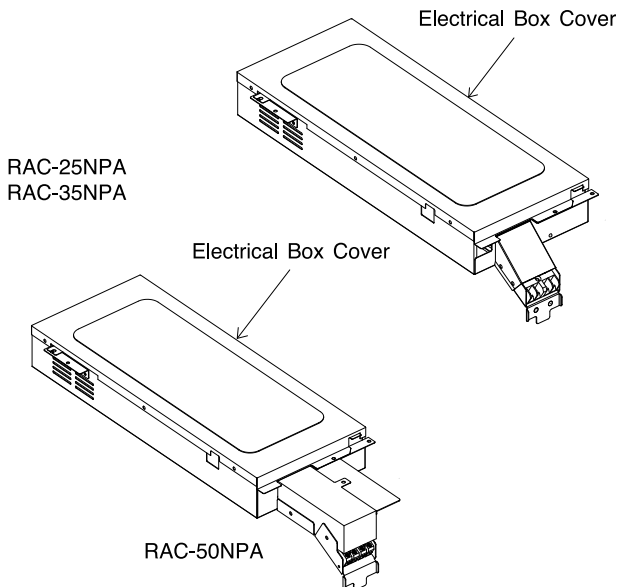

(Cautions)

- (1) If interface signal (DC 35V) terminals C and D are not connected when the outdoor unit is in forced cool mode, the outdoor unit defect indicator (LD301) will blink 9 times during operation to indicate communication error.
- (2) If checking is done with the compressor connector disconnected, the unit will continue normal operation when the electrical parts are normal, or it will repeat operating for approx. one minute and stop due to overload power limit cut, or it will operate in the overload status.

Be sure to push the service switch again to stop the forced cool operation.

HOW TO OPERATE THE OUTDOOR UNIT INDEPENDENTLY

1. Connect the large dia. pipe side and small dia. pipe side service valves using a pipe.

Connect the small diameter service valve and the large diameter service valve using the reducing union and copper pipe as shown on the right.

Charge refrigerant of 300g after vacuuming (※ 1)

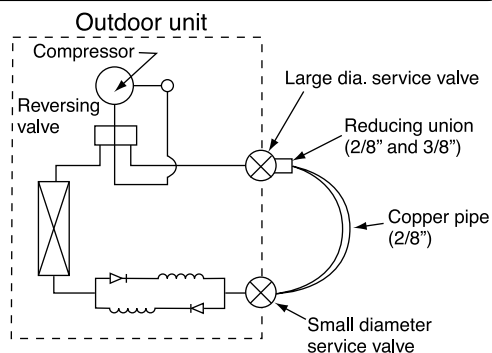

Parts to be prepared

- (1) Reducing union
2/8" (6.35mm)
1/2" (12.7mm)
- (2) Copper pipe (2/8" and 1/2")
- (3) Shorting leads
2 leads approx. 10 cm long with alligator clip or IC clip

Do not operate for more than 5 minutes

The operation method is the same as "How to operate using the connector to servicing the outdoor unit".

※ 1 The charging amount of 300g is equivalent to the load in normal operation.

SYSTEM POWER MODULE DIAGNOSIS

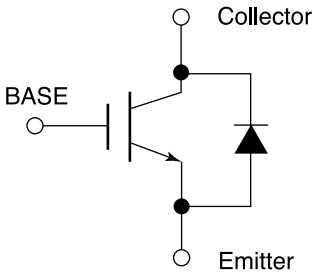
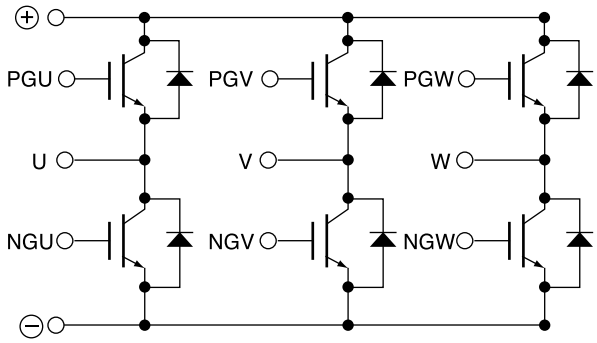
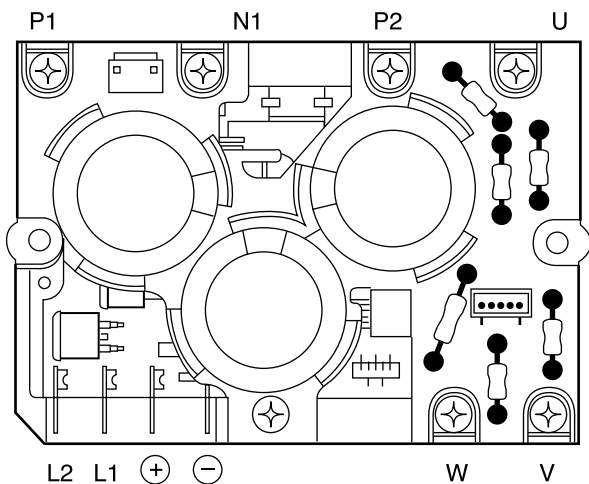
<p>Circuit diagram of the device (excepting the reflux diode)</p>	
<p>Circuit diagram of the module</p>	
<p>Terminals symbol mark of the module</p> <p>※ See next page for measuring value using tester</p>	

HOW TO CHECK SYSTEM POWER MODULE

Checking system power module using tester

Set tester to resistance range (X 100)

If indicator does not swing in the following conductivity check, the system power module is normal.

(In case of digital tester, since built-in battery is set in reverse direction, ⊕ and ⊖ terminals are reversed.)

⚠ CAUTION

If inner circuit of system power module is disconnected (open), the indicator of tester will not swing and this may assumed as normal. In this case, if indicator swings when ⊕ and ⊖ terminals are connected in reverse of diagram below, it is normal. Furthermore, compare how indicator swings at U, V and W phases. If indicator swings the same way at each point, it is normal.

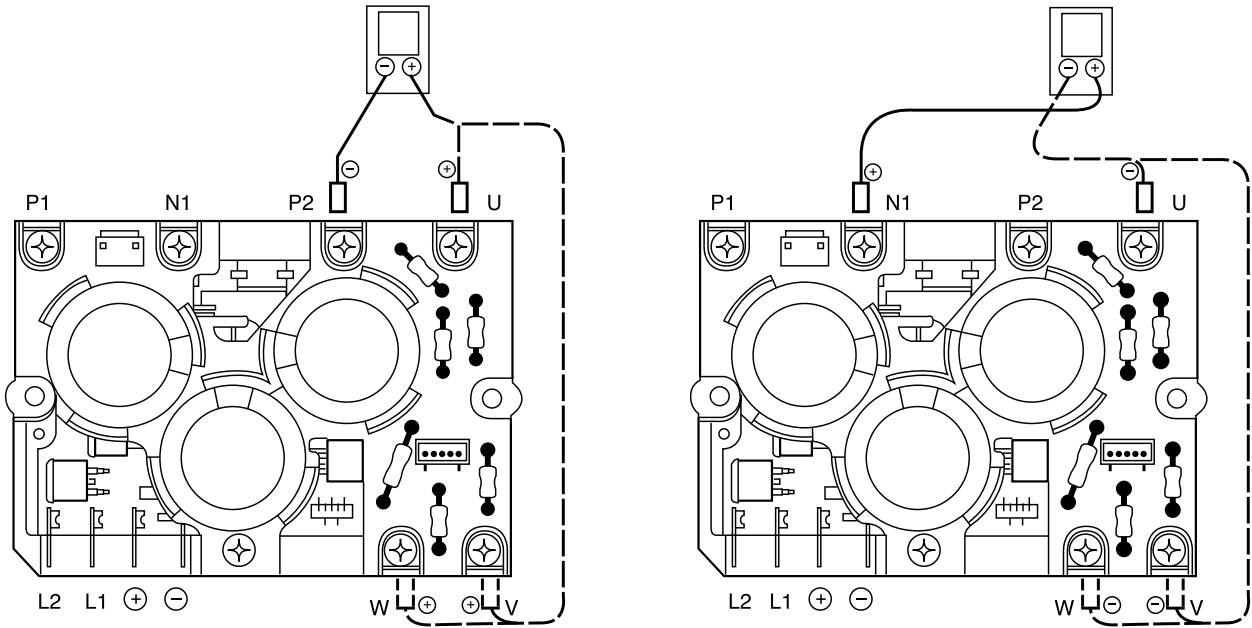

PARTS LIST AND DIAGRAM

INDOOR UNIT

MODEL : RAD-18RPA, RAD-25RPA, RAD-35RPA, RAD-50RPA

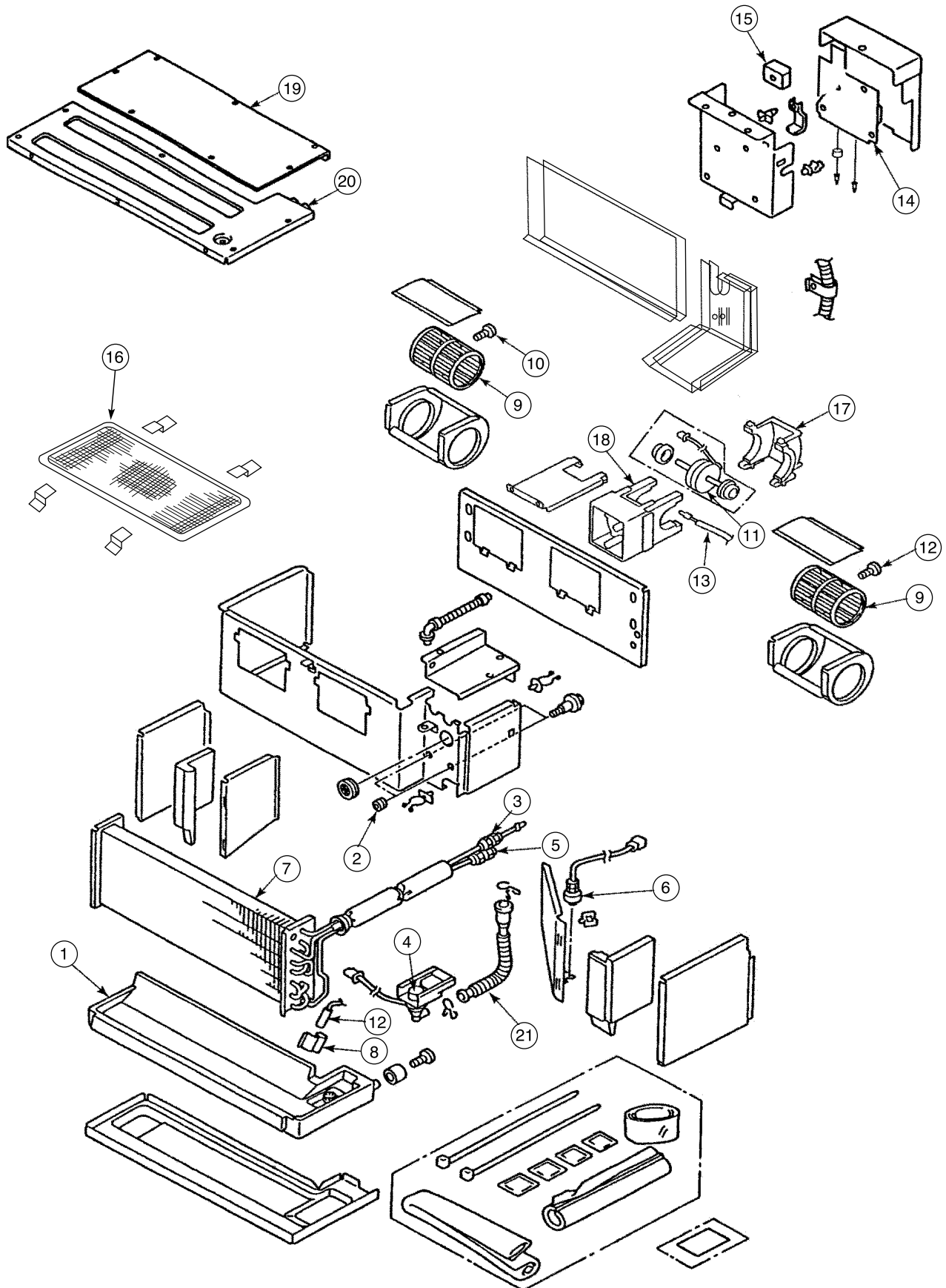

MODEL RAD-18RPA

NO.	PART NO. RAD-18RPA	Q'TY / UNIT	PARTS NAME
1	PMRAD-18RPA R03	1	DRAIN PAN
2	PMRAMD-350BW R03	2	FAN MOTOR SUPPORT RUBBER
3	PMRAD-18RPA R04	1	UNION (2)
4	PMRAD-28MX R02	1	DRAIN PUMP
5	PMRAD-18RPA R05	1	UNION (3)
6	PMRAMD-350BW R11	1	FLOAT SWITCH
7	PMRAD-18RPA R02	1	CYCLE ASSY
8	PMRAS-10C8M R03	1	THERMISTOR SUPPORT
9	PMRAD-32CNH2 S06	2	SIROCCO FAN
10	PMRA-353B R04	2	FAN BOLT
11	PMRAD-32CNH2 S05	1	FAN MOTOR
12	PMRAMD-40GX R02	1	THERMISTOR (HEAT)
13	PMRAD-28MX R05	1	THERMISTOR (TEMPERATURE)
14	PMRAD-18RPA R01	1	P.W.B. (MAIN)
15	PMRAM-90QH5 S01	1	TERMINAL BOARD (2P)
16	PMRAD-18NH7 002	1	FILTER
17	PMRAD-28QH1 S07	1	FAN MOTOR SUPPORT
18	PMRAD-25QH4 S01	1	BASE (FAN MOTOR)
19	PMRAD-18NH7 S03	1	UPPER PLATE (2)
20	PMRAD-25QH4 S04	1	UPPER PLATE (1)
21	PMRAD-28MX R03	1	DRAIN PIPE

MODEL RAD-25RPA

NO.	PART NO. RAD-25RPA	Q'TY / UNIT	PARTS NAME
1	PMRAD-18RPA R03	1	DRAIN PAN
2	PMRAMD-350BW R03	2	FAN MOTOR SUPPORT RUBBER
3	PMRAD-18RPA R04	1	UNION (2)
4	PMRAD-28MX R02	1	DRAIN PUMP
5	PMRAD-18RPA R05	1	UNION (3)
6	PMRAMD-350BW R11	1	FLOAT SWITCH
7	PMRAD-18RPA R02	1	CYCLE ASSY
8	PMRAS-10C8M R03	1	THERMISTOR SUPPORT
9	PMRAD-32CNH2 S06	2	SIROCCO FAN
10	PMRA-353B R04	2	FAN BOLT
11	PMRAD-32CNH2 S05	1	FAN MOTOR
12	PMRAMD-40GX R02	1	THERMISTOR (HEAT)
13	PMRAD-28MX R05	1	THERMISTOR (TEMPERATURE)
14	PMRAD-18RPA R01	1	P.W.B. (MAIN)
15	PMRAM-90QH5 S01	1	TERMINAL BOARD (2P)
16	PMRAD-18NH7 002	1	FILTER
17	PMRAD-28QH1 S07	1	FAN MOTOR SUPPORT
18	PMRAD-25QH4 S01	1	BASE (FAN MOTOR)
19	PMRAD-18NH7 S03	1	UPPER PLATE (2)
20	PMRAD-25QH4 S04	1	UPPER PLATE (1)
21	PMRAD-28MX R03	1	DRAIN PIPE

MODEL RAD-35RPA

NO.	PART NO. RAD-35RPA	Q'TY / UNIT	PARTS NAME
1	PMRAD-18RPA R03	1	DRAIN PAN
2	PMRAMD-350BW R03	2	FAN MOTOR SUPPORT RUBBER
3	PMRAD-18RPA R04	1	UNION (2)
4	PMRAD-28MX R02	1	DRAIN PUMP
5	PMRAD-18RPA R05	1	UNION (3)
6	PMRAMD-350BW R11	1	FLOAT SWITCH
7	PMRAD-18RPA R02	1	CYCLE ASSY
8	PMRAS-10C8M R03	1	THERMISTOR SUPPORT
9	PMRAD-32CNH2 S06	2	SIROCCO FAN
10	PMRA-353B R04	2	FAN BOLT
11	PMRAD-32CNH2 S05	1	FAN MOTOR
12	PMRAMD-40GX R02	1	THERMISTOR (HEAT)
13	PMRAD-28MX R05	1	THERMISTOR (TEMPERATURE)
14	PMRAD-35RPA R01	1	P.W.B. (MAIN)
15	PMRAM-90QH5 S01	1	TERMINAL BOARD (2P)
16	PMRAD-18NH7 002	1	FILTER
17	PMRAD-28QH1 S07	1	FAN MOTOR SUPPORT
18	PMRAD-25QH4 S01	1	BASE (FAN MOTOR)
19	PMRAD-18NH7 S03	1	UPPER PLATE (2)
20	PMRAD-25QH4 S04	1	UPPER PLATE (1)
21	PMRAD-28MX R03	1	DRAIN PIPE

MODEL RAD-50RPA

NO.	PART NO. RAD-50RPA	Q'TY / UNIT	PARTS NAME
1	PMRAD-18RPA R03	1	DRAIN PAN
2	PMRAMD-350BW R03	2	FAN MOTOR SUPPORT RUBBER
3	PMRAD-18RPA R04	1	UNION (2)
4	PMRAD-28MX R02	1	DRAIN PUMP
5	PMRAD-50RPA R03	1	UNION (4)
6	PMRAMD-350BW R11	1	FLOAT SWITCH
7	PMRAD-50RPA R02	1	CYCLE ASSY
8	PMRAS-10C8M R03	1	THERMISTOR SUPPORT
9	PMRAD-32CNH2 S06	2	SIROCCO FAN
10	PMRA-353B R04	2	FAN BOLT
11	PMRAD-32CNH2 S05	1	FAN MOTOR
12	PMRAMD-40GX R02	1	THERMISTOR (HEAT)
13	PMRAD-28MX R05	1	THERMISTOR (TEMPERATURE)
14	PMRAD-50RPA R01	1	P.W.B. (MAIN)
15	PMRAM-90QH5 S01	1	TERMINAL BOARD (2P)
16	PMRAD-18NH7 002	1	FILTER
17	PMRAD-28QH1 S07	1	FAN MOTOR SUPPORT
18	PMRAD-25QH4 S01	1	BASE (FAN MOTOR)
19	PMRAD-18NH7 S03	1	UPPER PLATE (2)
20	PMRAD-25QH4 S04	1	UPPER PLATE (1)
21	PMRAD-28MX R03	1	DRAIN PIPE

OUTDOOR UNIT MODEL : RAC-25NPA, RAC-35NPA

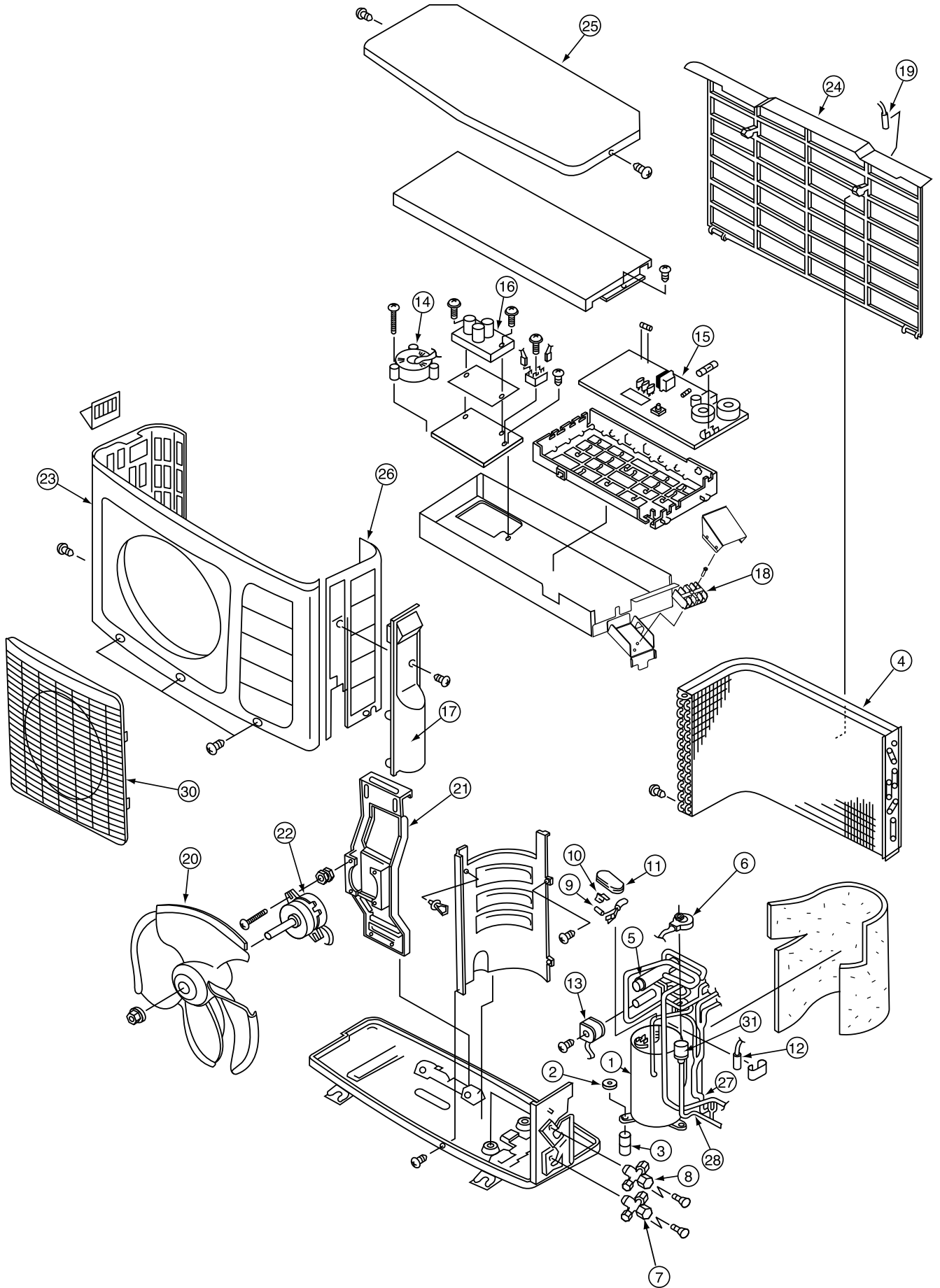

MODEL RAC-25NPA

NO.	PART NO. RAC-25NPA	Q'TY / UNIT	PARTS NAME
1	PMRAC-25NH4 S08	1	COMPRESSOR
2	KPNT1 001	6	PUSH NUT
3	RAC-2226HV 805	3	COMPRESSOR RUBBER
4	PMRAC-25NH4 S01	1	CONDENSER
5	PMRAC-X24CAT S02	1	REVERSING VALVE
6	PMRAC-25NPA S02	1	ELECTRICAL EXPANSION COIL
7	PMRAC-25NH4 S04	1	VALVE (2S)
8	PMRAC-X10CZ S17	1	VALVE (3S)
9	PMRAC-40CNH2 S14	1	THERMISTOR (OH)
10	PMRAC-25NH4 S09	1	OVERHEAT THERMISTOR SUPPORT
11	PMRAC-25NH4 S10	1	OVERLOAD RELAY COVER
12	PMRAC-40CNH2 S15	1	THERMISTOR (DEFROST)
13	PMRAC-60YHA1 902	1	COIL (REVERSING VALVE)
14	PMRAC-18SH4 S01	1	REACTOR
15	PMRAS-25NPA S01	1	P.W.B (MAIN)
	PMRAC-25NPA S91	1	P.W.B (MAIN) TUFFY (OPTIONAL)
16	PMRAC-25NH4 S12	1	SYSTEM POWER MODULE
17	PMRAC-S18CPA S01	1	SV COVER
18	PMRAC-25NH4 S13	1	TERMINAL BOARD (4P)
19	PMRAC-40CNH2 S16	1	THERMISTOR (OUTSIDE TEMPERATURE)
20	PMRAC-25CNH2 S02	1	PROPELLER FAN
21	PMRAC-25NH4 S14	1	SUPPORT (FAN MOTOR)
22	PMRAC-40CNH2 S19	1	FAN MOTOR (40W)
23	PMRAC-25NPA S04	1	CABINET
24	PMRAC-51CA1 908	1	NET
25	PMRAC-51CA1 909	1	TOP COVER
26	PMRAC-25NH4 S17	1	SIDE PLATE-R
27	PMRAC-25NH4 S15	1	STRAINER
28	PMRAC-25NH4 S07	1	STRAINER (COND)
30	PMRAC-09CHA1 903	1	GRILL
31	PMRAC-25NPA S03	1	EXPANSION VALVE

MODEL RAC-35NPA

NO.	PART NO. RAC-35NPA	Q'TY / UNIT	PARTS NAME
1	PMRAC-25NH4 S08	1	COMPRESSOR
2	KPNT1 001	6	PUSH NUT
3	RAC-2226HV 805	3	COMPRESSOR RUBBER
4	PMRAC-25NH4 S01	1	CONDENSER
5	PMRAC-X24CAT S02	1	REVERSING VALVE
6	PMRAC-25NPA S02	1	ELECTRICAL EXPANSION COIL
7	PMRAC-25NH4 S04	1	VALVE (2S)
8	PMRAC-X10CZ S17	1	VALVE (3S)
9	PMRAC-40CNH2 S14	1	THERMISTOR (OH)
10	PMRAC-25NH4 S09	1	OVERHEAT THERMISTOR SUPPORT
11	PMRAC-25NH4 S10	1	OVERLOAD RELAY COVER
12	PMRAC-40CNH2 S15	1	THERMISTOR (DEFROST)
13	PMRAC-60YHA1 902	1	COIL (REVERSING VALVE)
14	PMRAC-18SH4 S01	1	REACTOR
15	PMRAS-35NPA S01	1	P.W.B (MAIN)
	PMRAC-35NPA S91	1	P.W.B (MAIN) TUFFY (OPTIONAL)
16	PMRAC-25NH4 S12	1	SYSTEM POWER MODULE
17	PMRAC-25NH4 S21	1	SV COVER
18	PMRAC-25NH4 S13	1	TERMINAL BOARD (4P)
19	PMRAC-40CNH2 S16	1	THERMISTOR (OUTSIDE TEMPERATURE)
20	PMRAC-25CNH2 S02	1	PROPELLER FAN
21	PMRAC-25NH4 S14	1	SUPPORT (FAN MOTOR)
22	PMRAC-40CNH2 S19	1	FAN MOTOR (40W)
23	PMRAC-25NPA S04	1	CABINET
24	PMRAC-51CA1 908	1	NET
25	PMRAC-51CA1 909	1	TOP COVER
26	PMRAC-25NH4 S17	1	SIDE PLATE-R
27	PMRAC-25NH4 S15	1	STRAINER
28	PMRAC-25NH4 S07	1	STRAINER (COND)
30	PMRAC-09CHA1 903	1	GRILL
31	PMRAC-25NPA S03	1	EXPANSION VALVE

OUTDOOR UNIT MODEL : RAC-50NPA

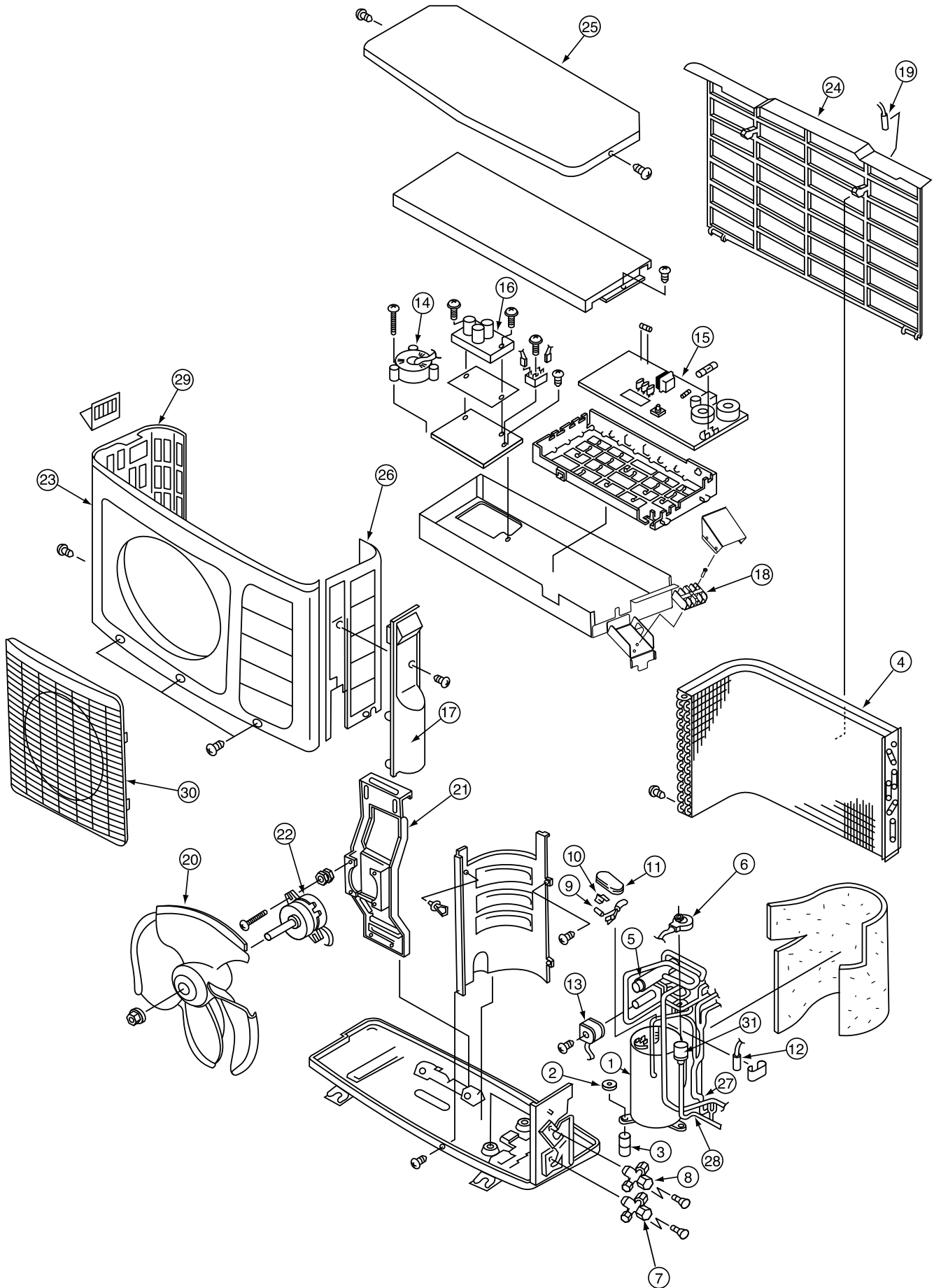

MODEL RAC-50NPA

NO.	PART NO. RAC-50NPA	Q'TY / UNIT	PARTS NAME
1	PMRAC-50NH4 S07	1	COMPRESSOR
2	KPNT1 001	4	PUSH NUT
3	RAC-2226HV 805	3	COMPRESSOR RUBBER
4	PMRAC-50NH4 S02	1	CONDENSER
5	PMRAC-X24CAT S02	1	REVERSING VALVE
6	PMRAC-25NPA S02	1	ELECTRICAL EXPANSION COIL
7	PMRAC-50NH4 S03	1	VALVE (2S)
8	PMRAC-50NH4 S04	1	VALVE (4S)
9	PMRAC-40CNH2 S14	1	THERMISTOR (OH)
10	PMRAC-25NH4 S09	1	OVERHEAT THERMISTOR SUPPORT
11	PMRAC-25NH4 S10	1	OVERLOAD RELAY COVER
12	PMRAC-40CNH2 S15	1	THERMISTOR (DEFROST)
13	PMRAC-60YHA1 902	1	COIL (REVERSING VALVE)
14	PMRAC-18SH4 S01	1	REACTOR
15	PMRAC-50NPA S01	1	P.W.B (MAIN)
	PMRAC-50NPA S91		P.W.B. (MAIN) TUFFY (OPTIONAL)
16	PMRAC-40CNH2 S01	1	SYSTEM POWER MODULE
17	PMRAC-50NH4 912	1	SV-COVER
18	PMRAC-25NH4 S13	1	TERMINAL BOARD (4P)
19	PMRAC-19SH4 S01	1	THERMISTOR (OUTSIDE TEMPERATURE)
20	PMRAC-40CNH2 S17	1	PROPELLER FAN
21	PMRAC-40CNH2 S18	1	SUPPORT (FAN MOTOR)
22	PMRAC-40CNH2 S19	1	FAN MOTOR
23	PMRAC-50NPA S02	1	CABINET
24	PMRAC-40CNH2 921	1	NET
25	PMRAC-40CNH2 922	1	TOP COVER
26	PMRAC-50NPA S03	1	SIDE PLATE-R
27	PMRAC-50NH4 S06	1	STRAINER (PIPE)
28	PMRAC-50NH4 909	1	STRAINER (COND)
29	PMRAC-40CNH2 926	1	SIDE PLATE-L
30	PMRAC-40CNH2 928	1	GRILL
31	PMRAC-25NH4 S16	1	EXPANSION VALVE

HITACHI

**RAD-18RPA
RAD-25RPA / RAC-25NPA
RAD-35RPA / RAC-35NPA
RAD-50RPA / RAC-50NPA**

PM NO. 0000E

Printed in Malaysia