

SET-FREE MINI series

Technical Catalogue

RAS-(4-6)FSVN2E
RAS-(4-6)FSNY2E

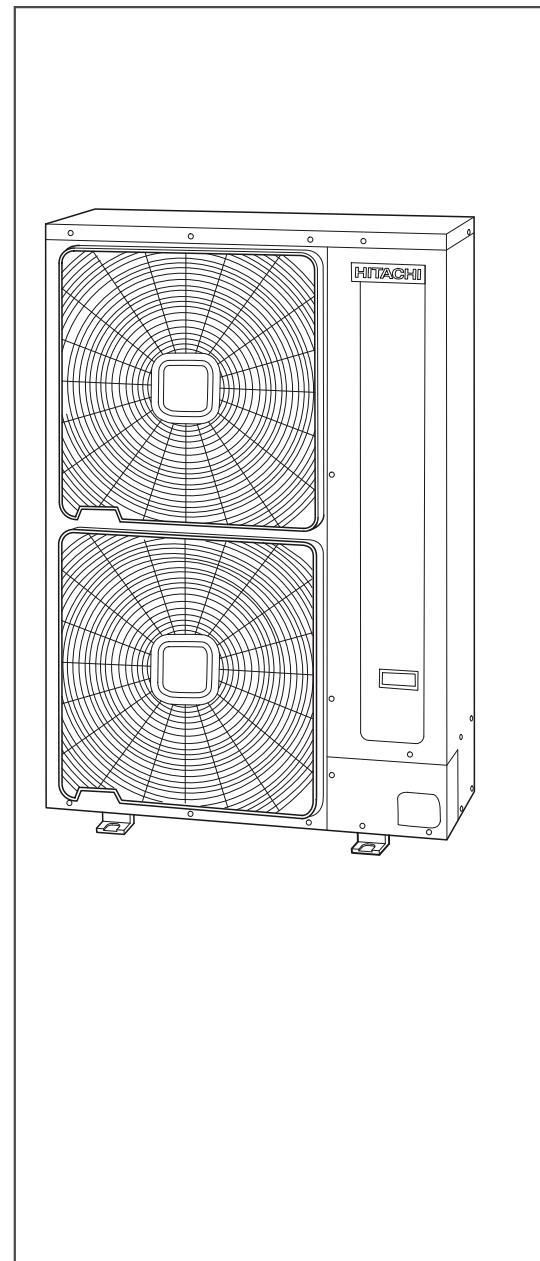

Index

General information	1
Features and benefits	2
General data	3
Capacities and selection data	4
Acoustic characteristic curves	5
Working range	6
General dimensions	7
Refrigerant cycle	8
Piping work and refrigerant charge	9
Electrical wiring	10
Optional functions	11
Troubleshooting	12

General Index

1.	General information	1
1.1.	General information	2
1.1.1.	General notes	2
1.1.2.	Introduction	2
1.1.3.	Environment-friendly units	2
1.2.	Applied symbols	3
1.3.	Product guide	4
1.3.1.	Classification of outdoor unit models	4
1.3.2.	Classification of indoor unit models	4
1.3.3.	Product guide: Outdoor units	5
1.3.4.	Product guide: Indoor units	6
1.3.5.	Accessory code list	9
2.	Features and benefits	11
2.1.	Selection benefits	12
2.1.1.	Wide range of units, accessories and remote controls	12
2.1.2.	High number of connectable indoor units	14
2.1.3.	Individual operation	15
2.1.4.	Assisted air conditioning installation design by Hi-Tool kit selection software	15
2.2.	Installation benefits	16
2.2.1.	Easy and flexible unit installation	16
2.2.2.	Easy and flexible electrical installation	16
2.2.3.	Easy and flexible control connection (Central Station, BMS Interface, CS-NET WEB)	18
2.3.	Start-up benefits	19
2.3.1.	Automatic start-up test	19
2.3.2.	Service verification	20
2.4.	Functionality benefits	21
2.4.1.	Expanded temperature range	21
2.4.2.	Wide capacity range	22
2.4.3.	Increased maximum piping length	22
2.4.4.	Advanced technology	23
2.5.	Maintenance benefits	32
2.5.1.	Minimum maintenance	32
2.5.2.	Easy accessibility	32
2.5.3.	Alarm codes	32
2.5.4.	SMS alarm	32
2.5.5.	Availability of maintenance tools	32
3.	General data	33
3.1.	General data	34
3.1.1.	General conditions	34
3.1.2.	RAS-4FS(V)N(Y)2E	35
3.1.3.	RAS-5FS(V)N(Y)2E	36
3.1.4.	RAS-6FS(V)N(Y)2E	37

3.2.	Component data	38
3.2.1.	RAS-(4-6)FSVN2E	38
3.2.2.	RAS-(4-6)FSNY2E	38
3.2.3.	Compressors	39
3.3.	Electrical data	40
3.3.1.	Considerations.....	40
3.3.2.	RAS-(4-6)FS(V)N(Y)2E	40
4.	Capacities and selection data.....	41
4.1.	System selection procedure	42
4.1.1.	SET FREE MINI system possibilities	42
4.1.2.	Selection parameters.....	45
4.1.3.	Selection procedure.....	45
4.2.	Cooling capacity tables	51
4.2.1.	Cooling capacity curve	51
4.2.2.	Nominal cooling capacity tables	52
4.2.3.	Cooling capacity tables according to total power of combined indoor units	53
4.3.	Heating capacity tables	68
4.3.1.	Heating capacity curve	68
4.3.2.	Nominal heating capacity tables.....	69
4.3.3.	Heating capacity tables according to total power of combined indoor units	70
4.4.	Correction factors	86
4.4.1.	Piping length correction factor	86
4.4.2.	Defrost correction factor	89
4.4.3.	Correction ratio due to humidity (CR)	89
5.	Acoustic characteristic curves	91
5.1.	Overall sound level.....	92
5.2.	Sound data	93
6.	Working range	95
6.1.	Working range	96
6.1.1.	Power supply	96
6.1.2.	Temperature range	96
7.	General dimensions.....	97
7.1.	Dimensions.....	98
7.2.	Service space.....	99
8.	Refrigerant cycle.....	101
8.1.	RAS-(4-6)FS(V)N(Y)2E	102
9.	Piping work and refrigerant charge	103
9.1.	Refrigerant piping selection.....	104
9.1.1.	Piping size selection	104
9.1.2.	Multi-kit or distributor selection	104

9.2.	Refrigerant piping range.....	105
9.2.1.	Refrigerant piping length	105
9.2.2.	Refrigerant piping size.....	107
9.3.	Piping materials.....	108
9.3.1.	Copper pipes and sizes	108
9.3.2.	Pipe connection	109
9.3.3.	Insulation	109
9.4.	Distribution method	110
9.5.	Refrigerant charge amount.....	113
9.5.1.	Refrigerant charge before shipment (W_0 (kg)).....	113
9.5.2.	Additional refrigerant charge calculation method	113
9.5.3.	Additional refrigerant charge calculation example	114
9.6.	Caution in case of refrigerant leakage.....	115
9.6.1.	Maximum permitted concentration of hydrofluorocarbon (HFC).....	115
9.6.2.	Calculation of refrigerant concentration.....	115
9.6.3.	Countermeasure for refrigerant leakage.....	115
10.	Electrical wiring	117
10.1.	General information.....	118
10.1.1.	General notes	118
10.1.2.	General verifications.....	118
10.2.	Setting of DIP switches and RSW switches	120
10.3.	Common wiring	122
10.3.1.	Electrical wiring between outdoor and indoor unit.....	122
10.3.2.	Wiring size	123
10.4.	H-LINK II system	124
10.4.1.	Application.....	124
10.4.2.	Features	124
10.4.3.	Specifications	124
10.4.4.	DIP switch setting for multiple H-LINK system	125
10.4.5.	Examples of the system of connection between H-LINK and H-LINK II units	126
10.4.6.	Examples of H-LINK II system.....	127
11.	Optional functions	129
11.1.	RAS-(4-6)FS(V)N(Y)2E	130
11.2.	For operation with CS-NET WEB.....	131
12.	Troubleshooting.....	133
12.1.	On-screen displays during abnormal operation	134
12.2.	Alarm codes	135

1. General information

Index

1.1. General information.....	2
1.1.1. General notes.....	2
1.1.2. Introduction.....	2
1.1.3. Environment-friendly units.....	2
1.2. Applied symbols.....	3
1.3. Product guide.....	4
1.3.1. Classification of outdoor unit models.....	4
1.3.2. Classification of indoor unit models.....	4
1.3.3. Product guide: Outdoor units.....	5
1.3.4. Product guide: Indoor units.....	6
1.3.5. Accessory code list.....	9

1

1.1 General information

1.1.1 General notes

No part of this publication may be reproduced, copied, filed or transmitted in any shape or form without the permission of HITACHI Air Conditioning Products Europe, S.A.

Within the policy of continuous improvement of its products, HITACHI Air Conditioning Products Europe, S.A. reserves the right to make changes at any time without prior notification and without being compelled to introducing them into products subsequently sold. This document may therefore have been subject to amendments during the life of the product.

HITACHI makes every effort to offer correct, up-to-date documentation. Despite this, printing errors cannot be controlled by HITACHI and are not its responsibility.

As a result, some of the images or data used to illustrate this document may not refer to specific models. No claims will be accepted based on the data, illustrations and descriptions included in this manual.

No type of modification must be made to the equipment without prior, written authorisation from the manufacturer.

1.1.2 Introduction

Hitachi presents the inverter-driven home central air-conditioning SET FREE mini series product, which is characterized by energy-saving, high efficiency, comfort, environmental protection, stability and reliability. In order to meet the requirement of increasing the control intelligence of equipment and of comfort, the intelligent control, energy-saving operation and comfortableness are more important. Especially the business building, building office, villa, apartment and residential area etc, need an intelligent and comfortable environment through all year. The better air conditioning solution can be provided for these buildings by inverter- driven and scroll compressor that the structure can be improved.

1.1.3 Environment-friendly units

This range of HITACHI outdoor units uses environmentally-friendly R410A gas refrigerant, and the RoHS and Green Dot regulations are applied throughout the manufacturing and installation process to reflect HITACHI's awareness of environmental respect and commitment.

R410A is totally environmentally-friendly since it does not contain any substances that damage the ozone layer: ODP (ozone depleting product) =0.



1.2 Applied symbols

During normal air conditioning system design work or unit installation, greater attention must be paid in certain situations requiring particular care in order to avoid damage to the unit, the installation or the building or property.

Situations that jeopardise the safety of those in the surrounding area or that put the unit itself at risk will be clearly indicated in this manual.

To indicate these situations, a series of special symbols will be used to clearly identify these situations.

Pay close attention to these symbols and to the messages following them, as your safety and that of others depends on it.



DANGER

- *The text following this symbol contains information and instructions relating directly to your safety and physical wellbeing.*
- *Not taking these instructions into account could lead to serious, very serious or even fatal injuries to you and others in the proximities of the unit.*

In the texts following the danger symbol you can also find information on safe procedures during unit installation.



CAUTION

- *The text following this symbol contains information and instructions relating directly to your safety and physical wellbeing.*
- *Not taking these instructions into account could lead to minor injuries to you and others in the proximities of the unit.*
- *Not taking these instructions into account could lead to unit damage.*

In the texts following the caution symbol you can also find information on safe procedures during unit installation.



NOTE

- *The text following this symbol contains information or instructions that may be of use or that require a more thorough explanation.*
- *Instructions regarding inspections to be made on unit parts or systems may also be included.*

1.3 Product guide









1.3.1 Classification of outdoor unit models

Unit type (Outdoor unit):									
Position-separating hyphen (fixed)									
Compressor power (HP): 4, 5, 6									
FS = SET-FREE system									
V = Single phase unit (1~ 230V 50Hz)									
N = R410A refrigerant									
Y = Three phase unit (3N~ 400V 50Hz)									
Series									
E = Made in Europe									
RAS	-	X	FS	(V)	N	(Y)	2	E	

1.3.2 Classification of indoor unit models

Unit type (indoor unit): RCI, RCIM, RCD, RPC, RPI, RPIM, RPK, RPF, RPF1									
Position-separating hyphen (fixed)									
Capacity (HP): 0.8, 1, 1.5, 2, 2.5, 3, 4, 5, 6									
FS = SYSTEM FREE									
N = R410A refrigerant									
H = Hotel (RPK-(1.0/1.5) only)									
2/3 = series									
E = Made in Europe									
M = Made in Malaysia									
- = Made in Japan									
DU = Drain Up (RPIM only)									
XXX	-	X.X	FS	N	(H)	(X)	(X)	(-DU)	

1.3.3 Product guide: Outdoor units

Outdoor units			
 			
1~		3N~	
FSVN2E		FSNY2E	
			
Unit	Code	Unit	Code
RAS-4FSVN2E 	7E320007	RAS-4FSNY2E 	7E320107
RAS-5FSVN2E 	7E320008	RAS-5FSNY2E 	7E320108
RAS-6FSVN2E 	7E320009	RAS-6FSNY2E 	7E320109



 **NOTE**



Check the exact classification for each unit (model, type, power and series) in [Classification of outdoor unit models](#).



1.3.4 Product guide: Indoor units

◆ RCI, RCIM and RCD indoor units

FSN(2/3)(E) indoor units							
RCI		RCIM		RCD			
							
4-way cassette		4-way cassette (compact)		2-way cassette			
Unit	Code	Unit	Code	Unit	Code		
RCI-1.0FSN3E	7E403001	RCIM-1.0FSN2	60278011	RCD-1.0FSN2	60278029		
RCI-1.5FSN3E	7E403002	RCIM-1.5FSN2	60278013	RCD-1.5FSN2	60278030		
RCI-2.0FSN3E	7E403003	RCIM-2.0FSN2	60278014	RCD-2.0FSN2	60278031		
RCI-2.5FSN3E	7E403004			RCD-2.5FSN2	60278032		
RCI-3.0FSN3E	7E403005			RCD-3.0FSN2	60278033		
RCI-4.0FSN3E	7E403007					RCD-4.0FSN2	60278034
RCI-5.0FSN3E	7E403008					RCD-5.0FSN2	60278035
RCI-6.0FSN3E	7E403009						

Panels							
RCI		RCIM		RCD			
							
P-N23NA	70531000	P-N23WAM	60197160	P-N23DNA	60297211	P-N46DNA	60297212



NOTE

- Check the exact classification for each unit (model, type, power and series) in [Classification of indoor unit models](#).
- The RCI, RCIM and RCD models must be used in combination with the panels indicated above.

◆ **RPC, RPI and RPIM indoor units**



FSN(2/3)E indoor units					
RPC		RPI		RPIM	
					
Ceiling type		Indoor ducted unit			
Unit	Code	Unit	Code	Unit	Code
		RPI-0.8FSN2E	7E420000	RPIM-0.8FSN2E	7E430000
				RPIM-0.8FSN2E-DU	7E431000
		RPI-1.0FSN2E	7E420001	RPIM-1.0FSN2E	7E430001
				RPIM-1.0FSN2E-DU	7E431001
		RPI-1.5FSN2E	7E420002	RPIM-1.5FSN2E	7E430002
				RPIM-1.5FSN2E-DU	7E431002
RPC-2.0FSN2E	7E440003	RPI-2.0FSN3E	7E424003		
RPC-2.5FSN2E	7E440004	RPI-2.5FSN3E	7E424004		
RPC-3.0FSN2E	7E440005	RPI-3.0FSN3E	7E424005		
RPC-4.0FSN2E	7E440007	RPI-4.0FSN3E	7E424007		
RPC-5.0FSN2E	7E440008	RPI-5.0FSN3E	7E424008		
RPC-6.0FSN2E	7E440009	RPI-6.0FSN3E	7E424009		



NOTE

Check the exact classification for each unit (model, type, power and series) in [Classification of indoor unit models](#).

◆ **RPK, RPF and RPF indoor units**

FSN(H)2(E/M) indoor units					
RPK		RPF		RPF	
					
Wall type		Floor type		Floor concealed type	
Unit	Code	Unit	Code	Unit	Code
RPK-1.0FSN2M	60277941	RPF-1.0FSN2E	7E450001	RPFI-1.0FSN2E	7E460001
RPK-1.0FSNH2M	60277961			RPFI-1.5FSN2E	7E460002
RPK-1.5FSN2M	60277942	RPF-1.5FSN2E	7E450002	RPFI-2.0FSN2E	7E460003
RPK-1.5FSNH2M	60277962			RPFI-2.5FSN2E	7E460004
RPK-2.0FSN2M	60277943				
RPK-2.5FSN2M	60277944				
RPK-3.0FSN2M	60277945				
RPK-4.0FSN2M	60277946				
EV-1.5N ⁽¹⁾	60291612				



⁽¹⁾ For RPK-1.0FSNH2M and RPK-1.5FSNH2M models only.



NOTE

Check the exact classification for each unit (model, type, power and series) in [Classification of indoor unit models](#).

1.3.5 Accessory code list

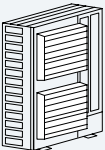
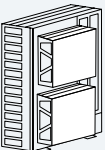
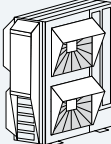
Name	Description	Code	Figure
DBS-26	Drain discharge connection	60299192	
E-102SN2	Branch pipe kit (multikit)	70524001	
MH-84AN	Header branch (Distributor)	70522007	
MH-108AN	Header branch (Distributor)	70522008	
AG-335A	Air flow guide	60291431	
WSP-335A	Wind guard	60291432	
ASG-NP335F	Snow protection hood; air outlet (Zinc plate)	60291433	
ASG-NP335FS2	Snow protection hood; air outlet (Stainless plate)	-	
ASG-NP280B	Snow protection hood; air inlet of rear side (Zinc plate)	-	
ASG-NP280BS2	Snow protection hood; air inlet of rear side (Stainless plate)	-	
ASG-NP280L	Snow protection hood; air inlet of left side (Zinc plate)	-	
ASG-NP280LS2	Snow protection hood; air inlet of left side (Stainless plate)	-	



NOTE

HITACHI has a range of accessories and remote control systems that can be used with the SET-FREE mini outdoor units. Please, refer to the Controls Technical Catalogue.

2. Features and benefits

2

Index

2.1.	Selection benefits	12
2.1.1.	Wide range of units, accessories and remote controls	12
2.1.2.	High number of connectable indoor units	14
2.1.3.	Individual operation	15
2.1.4.	Assisted air conditioning installation design by Hi-Tool kit selection software	15
2.2.	Installation benefits	16
2.2.1.	Easy and flexible unit installation	16
2.2.2.	Easy and flexible electrical installation	16
2.2.3.	Easy and flexible control connection (Central Station, BMS Interface, CS-NET WEB)	18
2.3.	Start-up benefits	19
2.3.1.	Automatic start-up test	19
2.3.2.	Service verification	20
2.4.	Functionality benefits	21
2.4.1.	Expanded temperature range	21
2.4.2.	Wide capacity range	22
2.4.3.	Increased maximum piping length	22
2.4.4.	Advanced technology	23
2.5.	Maintenance benefits	32
2.5.1.	Minimum maintenance	32
2.5.2.	Easy accessibility	32
2.5.3.	Alarm codes	32
2.5.4.	SMS alarm	32
2.5.5.	Availability of maintenance tools	32

2.1 Selection benefits

2.1.1 Wide range of units, accessories and remote controls

◆ Outdoor unit



The SET-FREE mini series from HITACHI offers (3-6)HP range of outdoor units for being selected in single or three phase combinations.

Model		Capacity (HP)		
		4	5	6
FSVN2E		●	●	●
		●	●	●

◆ Indoor unit

The HITACHI indoor units to connect with this SET-FREE mini series have a wide range of capacities: from 0.8 to 6.0 HP. The capacity of each indoor unit is flexible: they are supplied set to the maximum capacity possible and can be easily adjusted to precise lower values in line with installation requirements.

Model		Capacity (HP)											
		0.8	1.0	1.3	1.5	1.8	2.0	2.3	2.5	3.0	4.0	5.0	6.0
RCI 4-way cassette			●	●	●	●	●	●	●	●	●	●	●
RCIM 4-way cassette (compact)			●	●	●	●	●						
RCD 2-way cassette			●	●	●	●	●	●	●	●	●		
RPC ceiling type						●	●	●	●	●	●	●	●
RPI Indoor ducted unit (low profile)		●	●	●	●								
RPI Indoor ducted unit						●	●	●	●	●	●	●	●
RPIM Indoor ducted unit		●	●	●	●								
RPK wall type			●	●	●	●	●		●	●	●		

Model		Capacity (HP)											
		0.8	1.0	1.3	1.5	1.8	2.0	2.3	2.5	3.0	4.0	5.0	6.0
RPF floor type			●	●	●	●	●	●	●				
RPFI floor concealed type			●	●	●	●	●	●	●				

- Constant capacity unit.
- Unit with a capacity that can be set to a lower margin using the DIP switch.
- Capacity available with the DIP switch configuration.

◆ **Accessories**

All the outdoor units have a range of accessories that facilitate installation, operation and maintenance.

These accessories are designed to adapt the unit to the type of installation that the air conditioning system requires and improve its performance, always bearing in mind the quality parameters required.

The range of accessories includes:

- Remote controls, for handling and managing the operation of the installation.
- Multikits and distributors for pipe branches connection of indoor units.
- Drain discharge connection, to collect the draining.
- Air flow guide, wind guard and snow protection hood, to protect the outdoor unit fans and the air inlet/outlet.

◆ **Remote controls**

HITACHI has a range of remote control systems that are classified according to the type of management and the number of units they manage:

- Individual remote control systems.
- Centralised remote control systems.
- Building air conditioning systems (CS-NET WEB).
- BMS (Building Management Systems).

Individual remote control systems

The individual remote control systems, whether they are wireless or connected directly by cable, have a wide range of functions for easier unit management, the programming of specific settings or the identification of incidents. Recommended for managing a small number of units.



Centralised remote control systems

The centralised remote control systems combine the functions of the remote controls and extend the management and setting possibilities for several air conditioning systems distributed around the entire floor of a building.



Computerised control systems

Computerised control systems increase management and setting possibilities and allow this to be carried out from any point of the local communication network, by means of a two-core non-polarity cable or even using the Internet.

Recommended when you wish to independently manage more than two plants in one building.



◆ BMS (Building Management System)

Integration into installations with intelligent management. Gateway interface with Lonworks, KNX, MODBUS and BACnet BMS systems.



2.1.2 High number of connectable indoor units

With SET-FREE FS(V)N(Y)2E system it is possible to connect one outdoor unit with up to 9 indoor units. Utilizing an inverter control, a wide range of operation capacity control is also available. A maximum total combination horsepower of 130% and a minimum total combination horsepower of 50% can be chosen by combination of the indoor units when compared with the nominal outdoor unit capacity. Therefore, the system can meet individual air conditioning requirements in most office buildings.

Outdoor unit	Indoor unit				
	Minimum nominal combination capacity (HP)	Maximum nominal combination capacity (HP)	Minimum combination quantity of indoor units	Maximum combination quantity of indoor units	Minimum single operation capacity (HP)
RAS-4FS(V)N(Y)2E	2.0	5.2	1	6	0.8
RAS-5FS(V)N(Y)2E	2.5	6.5	1	8	0.8
RAS-6FS(V)N(Y)2E	3.0	7.8	1	9	0.8



NOTE

The following conditions should be complied when the 5HP and 6HP outdoor units are connected with 8 or 9 indoor units:

- *The capacity of simultaneously operated indoor unit should be less than that of outdoor unit.*
- *When heating, the outdoor temperature should be higher than -5°C.*
- *The maximum piping length (actual length) should be less than 40m; the distance from all multi-kits to indoor unit should be less than 5m.*

2.1.3 Individual operation

SET-FREE mini series individual operation function allows to control the connected indoor units separately.

- In case of installing the indoors units in the same room, one unit could continue operating -A- although the other one -B- stops by thermo-off, which means an energy saving and great comfort.

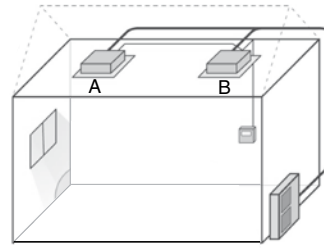

2

2.1.4 Assisted air conditioning installation design by Hi-Tool kit selection software

The Hi-Tool Kit selection software is a tool for designing HVAC installations and automatically generating all necessary related information to complete the planned installation.

The necessary related information includes:

- Product selection table.
- Cooling and wiring diagram according to the installation design.
- Full list of necessary products to complete the installation.
- Installation start-up management.



2.2 Installation benefits

2.2.1 Easy and flexible unit installation

◆ Reduced installation space by individual operation

- For Indoor units installed in different rooms, the benefits are:
 - Outdoor installation space reduced to half.
 - Decrease piping installation work and cost.
 - Decrease wiring and power equipment.

A. Model without individual operation function.

B. FS(V)N(Y)2E model.

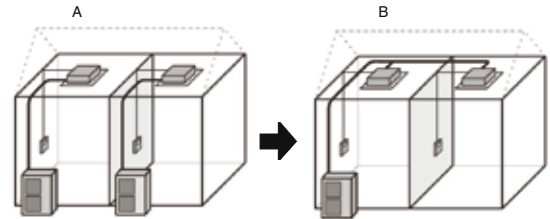

◆ Different mounting accessories available

HITACHI provides all of the accessories required to connect the pipes (distributors and multikits). These accessories make the installation process more flexible and straightforward.

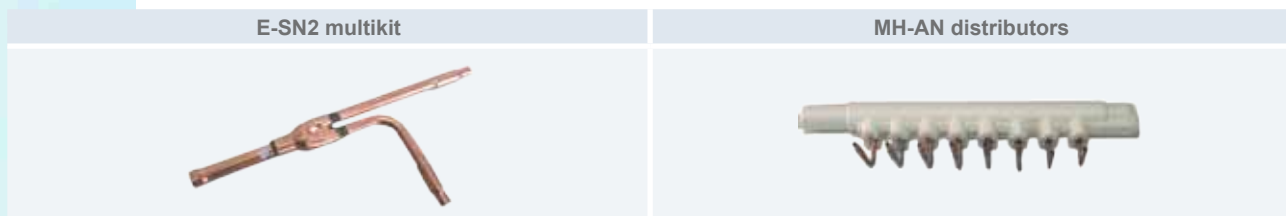

2.2.2 Easy and flexible electrical installation

◆ Interconnection of units via H-LINK II

The units interconnect via a bus called H-LINK II, consisting of 2 non-polarity cables which accept lengths of up to 1,000m. Accessories are available if required to increase this length up to 5,000m (PSC-5HR).



NOTE

The control system, the indoor units and the remote control must be compatible with the H-LINK II bus.

◆ Up to 160 units connected in a single H-LINK II bus line

It is possible to connect up to 160 indoor units from the SYSTEM FREE range in a single H-LINK II bus line. To expand the installation or increase the bus lines available, simply add a new line.

All of the units are managed as one through the control systems installed.

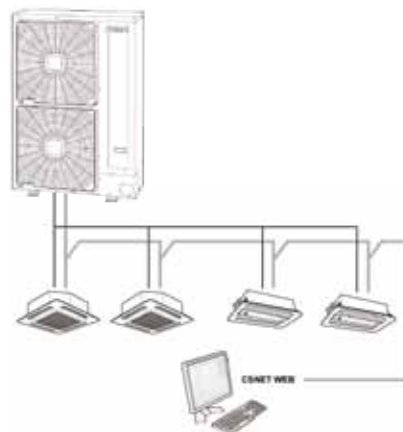

Specifications	
Transmission cable:	2-core
Transmission cable polarity:	No polarity
Maximum number of outdoor units connected:	64 units per H-LINK II system
Maximum number of indoor units connected:	160 units per H-LINK II system
Maximum number of units:	200
Maximum wiring length:	Total 1,000 m (including CSNET-WEB)
Recommended cable:	Shielded twisted pair cable or shielded pair cable over 0.75 mm ² (equivalent to KPEV-S)
Voltage:	5 V DC



NOTE

- **The DIP switches must be adjusted when the H-LINK II bus is used. If they are set incorrectly, a transmission error may occur.**
- **The H-Link II system offers a high level of flexibility for the design of air conditioning systems, due to its simple installation and the low total cost. Furthermore, centralised management is possible by connecting the CSNET-WEB control system to the H-LINK II network cables.**
- **Additionally, using CSNET-WEB, it is possible to manage the installation over the internet.**

◆ **No operating cable for the remote control**

In the case of multiple systems the indoor units can be controlled using a single remote control switch without having to join them with an operating cable for the remote control.

A. Operation wiring.

B. An operating cable is not required for using the remote control switch.

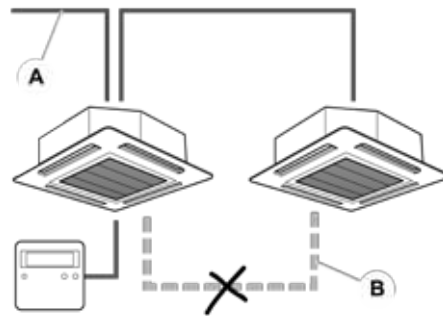

NOTE

- **When using the H-LINK II system, DIP switches have to be adjusted. If the DIP switches are not set or set incorrectly, an alarm may occur due to transmission failure. Total wiring length for the remote control switch can be extended to up to 5,000 m. If total wiring length is less than 30 m, it is possible to use the normal wiring (0.3 mm²).**
- **The H-LINK II system provides maximum flexibility for system design; installation is easy, and total costs are reduced. Furthermore, it can be controlled centrally by connecting CS-NET WEB to H-LINK II wiring.**
- **You can also control the installation by Internet via CS-NET WEB.**

2.2.3 Easy and flexible control connection (Central Station, BMS Interface, CS-NET WEB)

◆ **Fast connection of new units**

Extending the air conditioning system is now even easier. To add new units to the communication bus, it is only necessary to connect the two bus cables to the communication terminals.

The new units that are added to the bus line are recognised by the control system and are configured automatically.

◆ **Auto-configuration of system units**

The control systems for the air conditioning system are auto-configurable. In other words, they recognise the type of unit to which they are connected, and the type of indoor unit and its capacity. The installation is started up more quickly and efficiently.

You can also configure all the units manually, so as to adjust the installation following customised parameters.

2.3 Start-up benefits

2.3.1 Automatic start-up test

The installation is started up automatically, therefore considerably reducing the time required for the process.

There are the following types of start-up:

- Test run and identification of the units forming the system.
- Test run from the remote control.
- Test run from the outdoor unit.

Test run and identification of the system units

The automatic test run can be activated through outdoor unit DIP switch or indoor unit remote control switch. The outdoor unit 7-segment display gives all the information needed to check the system is operating correctly.

The units forming part of the system are identified separately for the outdoor and indoor units:

- Outdoor units: Using the remote control, the series to which each of the operational outdoor unit belongs (for example, simple or multiple series) can be assigned.
- Indoor units: Using the rotary and DIP switch on each unit.

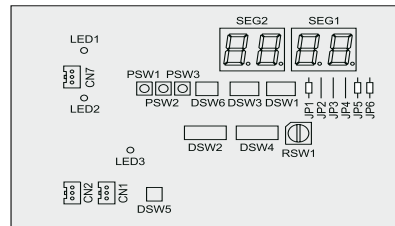

Test run from the remote control

The remote control can run 3 operations.

- Auto-diagnostic: quick check of the operating conditions of the indoor units and the outdoor unit.
- Data memory query: if an abnormality occurs, the LCD remote control switch shows an alarm code and saves all the operation settings of the unit at the time the fault occurs, so that a quick diagnosis can be made of the installation.
- Optional function setting: the remote control switch allows cancellation of the 4-degree offset in the heating mode and an increase in the fan speed setting, among 29 possible options.



This way, multiple indoor units can be set at the same time. Also, the configuration can easily be changed, even after the installation has been completed.

Test run from the outdoor unit

The outdoor unit PCB is equipped with a 7-segment display, which depending on the position of the PSWs shows the following parameters in sequence.

- Outdoor temperature.
- Discharge gas temperature.
- Evaporation temperature in heating mode.
- Condensing temperature.
- Discharge pressure.
- Compressor run time.

This allows quick and accurate diagnosis of the installation during normal operation or test run.

2.3.2 Service verification

◆ System operation control

The working order of the system is continuously monitored through the control system. All operating parameters that the system uses to manage the outdoor and indoor units are continuously supervised.

◆ Assisted-management air conditioning system

The air conditioning system can be managed conveniently using the assisted management software HITACHI Service Tools.

This software enables, for example, a laptop computer to be connected to the air conditioning system by means of an interface connected to the H-LINK II bus. Using different menus, the software allows you to manage all the systems connected effectively and obtain data to optimise system performance.



◆ Compilation of operating data

All the data obtained using HITACHI Service Tools is compiled in different formats and monitored in various ways. The user of the software can configure the data handling to monitor those parameters that are the most important in each installation.

The data reports allow you to verify the system operation continuously. Any deviation in the stipulated ranges of values are detected immediately.

2.4 Functionality benefits

2.4.1 Expanded temperature range

FS(V)N(Y)2E series are able to work in a wide working range (from -5 to 46 °C (DB) in cooling mode and from -20 to 15°C WB in heating mode).

The cooling working range has been increased up to 46°C in outdoor ambient temperature respect previous model (43°C).

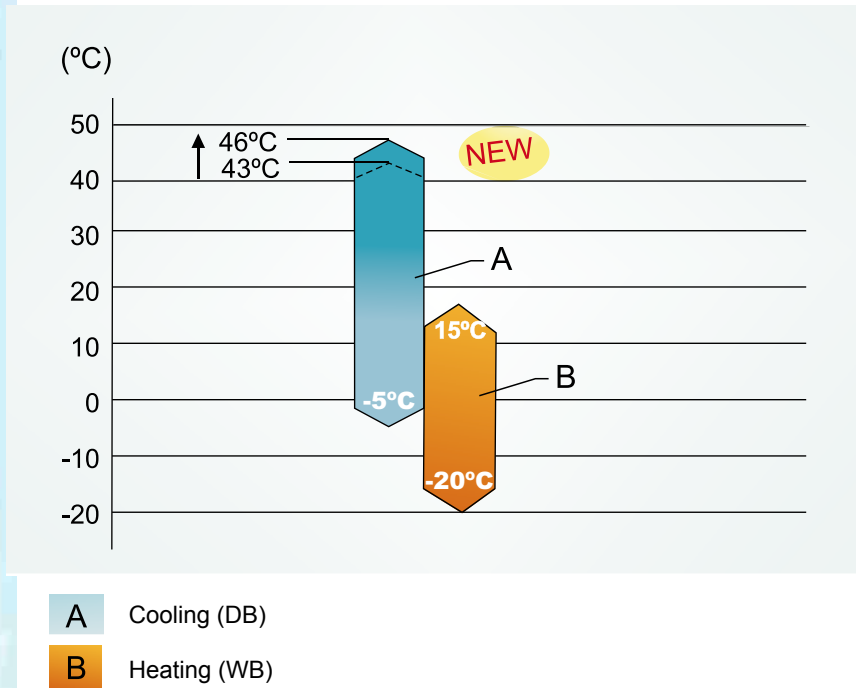

Fan regulation at low ambient temperature

- Wide working range thanks to fan control regulation, in cooling mode, for operating at low ambient temperature (down to -5°C DB).
- Fan control regulation enables working at low ambient temperature (down to -20°C WB), in heating mode, reducing “Defrost operations” or unit “stoppages” compared with conventional units.

2.4.2 Wide capacity range

The control frequency system allows a wide capacity application range as shown below:

- Cooling capacity range at conditions: Indoor air inlet: 27/19 °C (DB/WB); Outdoor air inlet: 35 °C DB

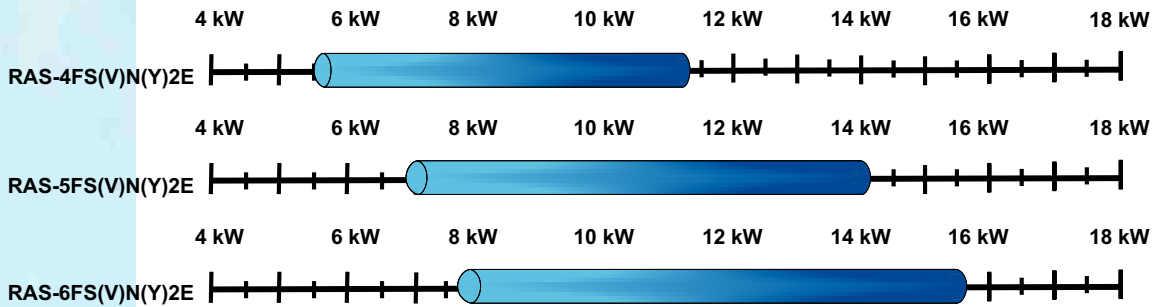

- Heating capacity range at conditions: Indoor air inlet: 20 °C DB; Outdoor air inlet: 7/6 °C (DB/WB)

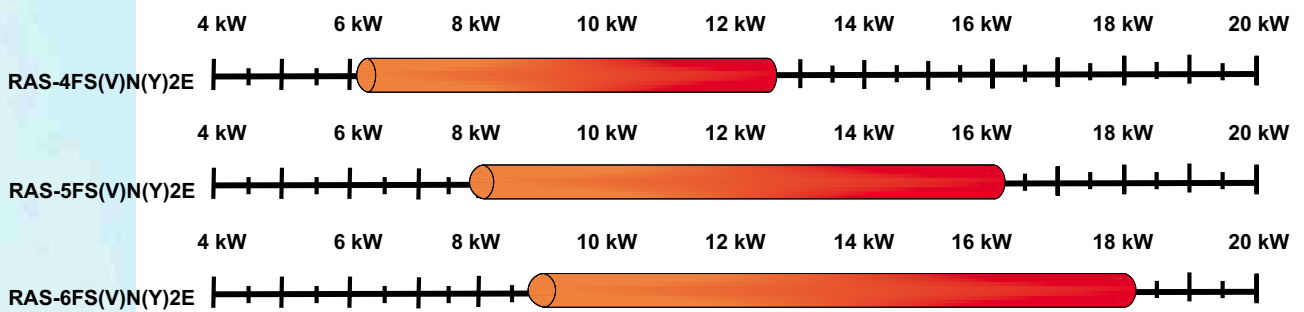

2.4.3 Increased maximum piping length

The total piping length is 125m for 4HP and 135m for 5~6HP;

- ① Actual Maximum piping length is 75m.
- ② Height difference between indoor and outdoor units is 30m.
- ③ Height difference between indoor units is 15m.
- ④ Piping length from the first multi-kit to the farthest indoor unit is 40m.

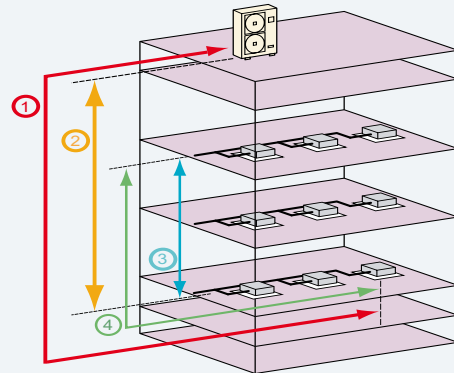

2.4.4 Advanced technology

The functionality benefits explained before (Highly efficiency system, wide capacity range and expanded working range) are direct consequence of the advanced technology applied on all the system components.

Then, the main features on different components of the system will be detailed:

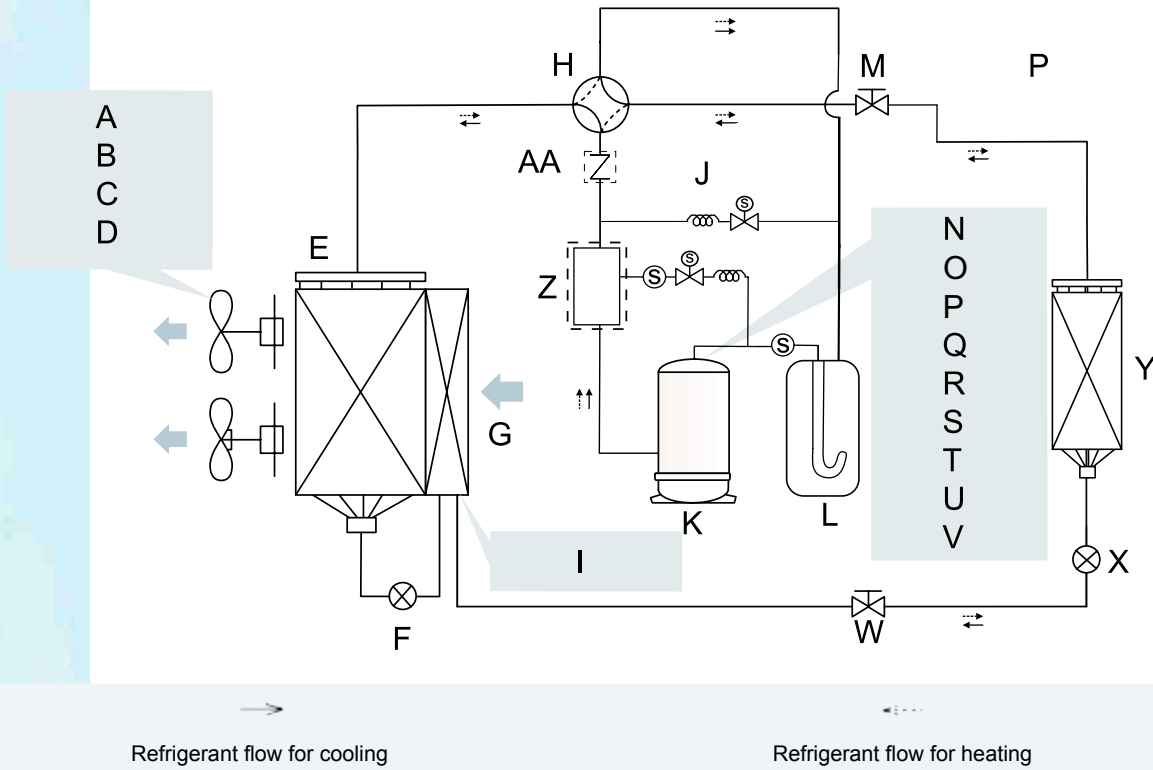

- A: Super high-stream fan.
- B: Side-flow technology.
- C: Silent fan unit.
- D: DC fan motor with outstanding efficiency.
- E: Outdoor unit heat exchanger.
- F: Outdoor unit expansion valve.
- G: Sub-cooling circuit.
- H: Reversing valve.
- I: Improved performance by sub-cooling circuit.
- J: Gas by-pass.
- K: Compressor.
- L: Accumulator.
- M: Stop valve of the gas pipe.

- N: Highly efficient scroll compressor.
- O: Two stage oil separator technology.
- P: Reduced power consumption.
- Q: High pressure shell.
- R: Lubrication.
- S: Protection against liquid return.
- T: Efficient design of stator coils.
- U: DC compressor with neodymium magnet.
- V: Low noise.
- W: Stop valve of the liquid pipe.
- X: Indoor unit expansion valve.
- Y: Indoor unit heat exchanger.
- Z: Oil separator
- AA: Check valve

◆ Heat exchanger

Improved performance by subcooling circuit

The system performance is improved by enlarged heat transfer area of FS(V)N(Y)2E unit and subcooler heat exchanger.

A: Rear side.

B: Front side.

C: Sub-cooler.

D: Air inlet.

E: Air outlet.

F: Increase of enthalpy due to the use of the sub-cooling circuit.

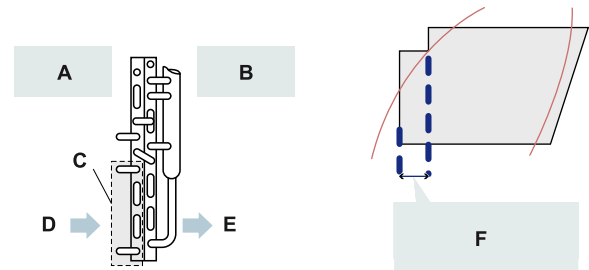

◆ Fan unit

Super high-stream fan

The outdoor units have been designed with a new super high-stream fan of $\varnothing 544$ mm, reducing the sound level and increasing its reliability, by the use of a three-blade design propeller.

This fan is much more aerodynamic than earlier models. It has a greater surface area in contact with the air and a better turning angle, preventing turbulence and allowing the ventilator to be fitted lower.

Additionally, the rib structure synchronized with rotation flow from the fan reduces the air resistance at the air outlet grille.

A: Optimized distribution at air outlet angle.

B: Optimized distribution at air inlet angle.

C: Increased angular advance.

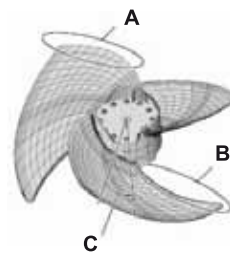

Side flow technology

Energy-saving and uniform air velocity distribution by side flow technology.

A: Air inlet.

B: Air outlet.

C: Air speed (m/s).

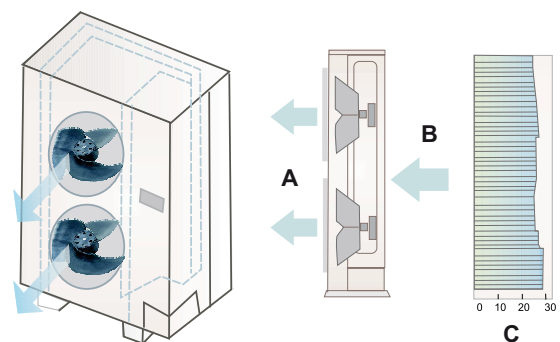

Silent fan unit

Low noise due to the following aspects:

- Combination of the three-blade and slim fan: The fan has been designed to have a lower body than traditional fans, and achieves surprising results, with a noise reduction of up to 4dB (A).

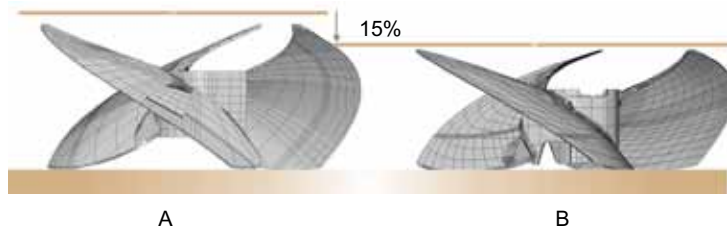

A: Conventional fan.

B: FS(V)N(Y)2E fan.

- DC fan motor: The smooth rotating fan motor with low vibration reduces the noise generation.



DC fan motor with outstanding efficiency

The DC fan motor greatly improves efficiency compared to conventional products with AC motors. In addition, air blasts are reduced by controlling the rotation speed of the fan. Stable operation is provided against strong head winds of approximately 10 m/s on the front face of the outdoor unit.

a: Motor efficiency (%).

b: Revolutions per Min. (rpm).

A: DC motor.

B: AC motor.

C: Efficiency increased by 40% (motor power consumption halved).

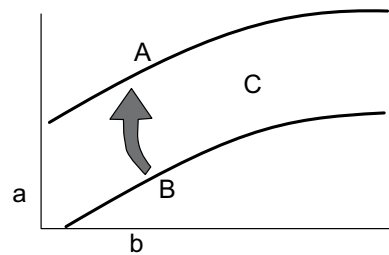

◆ **HITACHI exclusive scroll compressor**

Highly efficient scroll compressor

The HITACHI DC INVERTER scroll compressor has been developed to increase efficiency, reliability and to reduce power input:

- High performance at intermediate season.
- High efficiency at low speed (release valve and compacted winding of the DC-inverter motor).

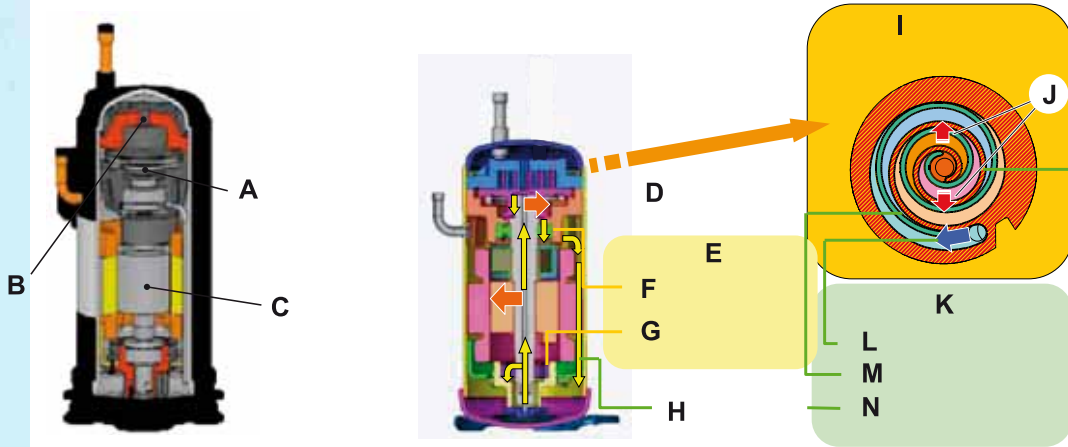

- A: New drive mechanism, oil feeding mechanism etc,...
- B: Newly developed scroll for R410A.
- C: DC-Inverter motor (compacted winding).
- D: Sub-bearing.
- E: High reliability.
- F: Decreased of bearing load.
- G: Minimizing of shaft swing.

- H: Oil return pipe.
- I: Asymmetric scroll lap.
- J: Shut out.
- K: High performance.
- L: Decrease of intake loss.
- M: Decrease of leak loss.
- N: Increase of superheat loss.

Two stage oil separator technology

The first oil separating should be done for SET FREE mini machine adopting the Hitachi special compressor having the high-efficient oil separating function. At the same time, the second oil separating can be achieved through equipping the oil separator on the discharge pipeline, so the oil separating effect ensures the system operation more stable and reliable.

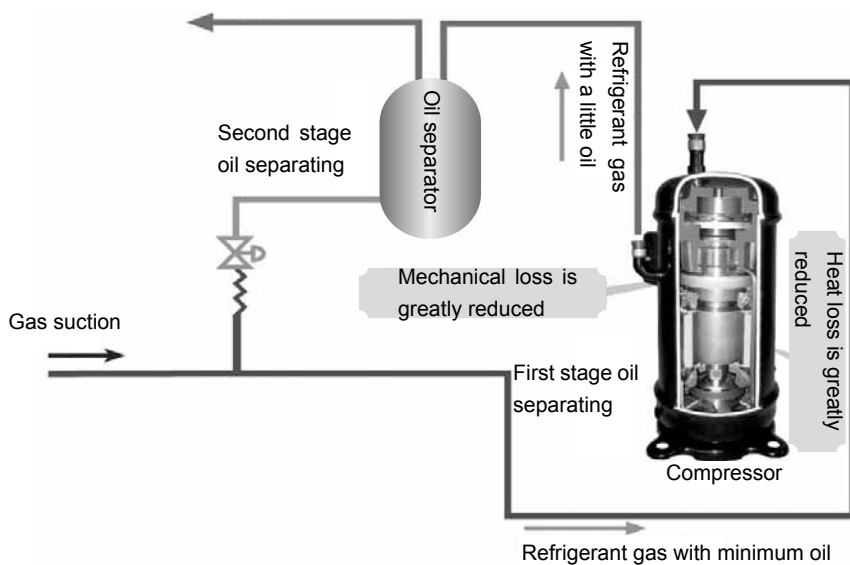

Reduced power consumption

- Highly efficient DC Scroll Compressor (use of neodymium magnets in the compressor motor rotor).
- New inverter control.
- Self demand control: Auto-control of power consumption, which can be regulated from 100%, 70% and 50% of nominal value. Avoids excess energy consumption by regulating the frequency.

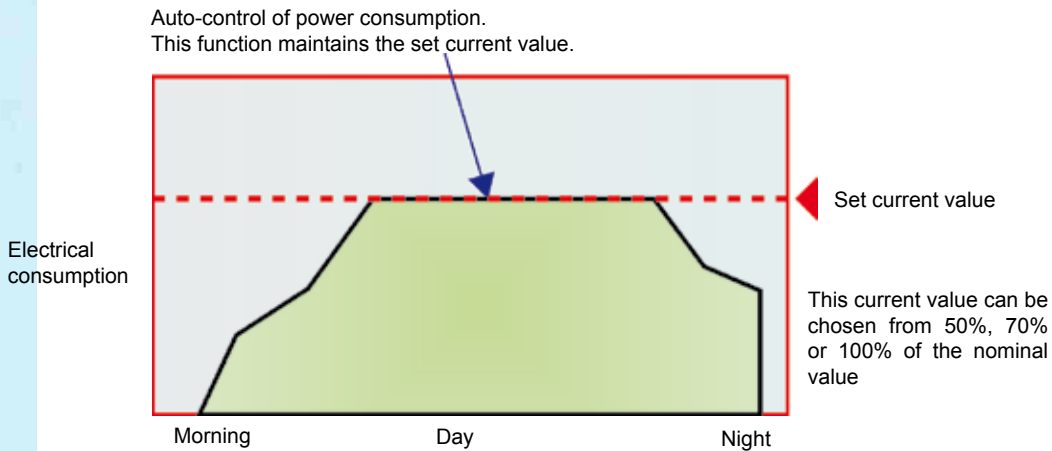

- Wave mode: Regulation of demand through wave control. The demand is regulated by controlling the wave.

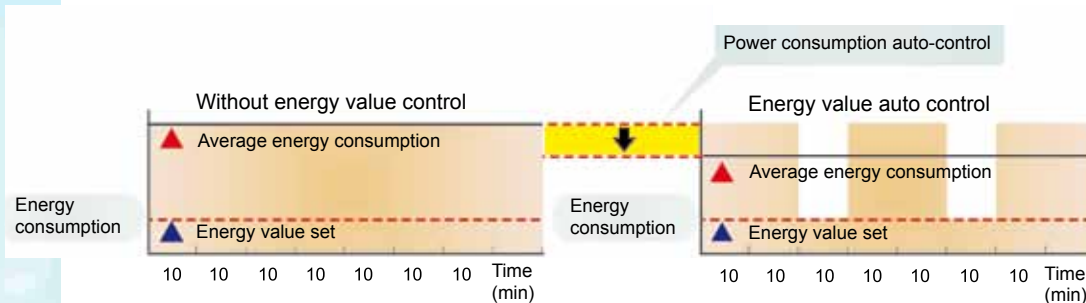

High pressure shell

- It acts as an oil separator reducing the amount of oil circulating in the cooling system giving better heat exchanger efficiency.
- Motor heat is not added to the suction gas before compression, which reduces the discharge gas temperature. This is particularly important at low suction temperatures. The discharge gas cools the motor sufficiently.
- Refrigerant cannot enter the shell during the off cycle causing oil dilution and oil foaming at start up.
- New system of regulating pressure, increasing the compressor's efficiency and reliability in part load mode. This system ensures the work pressure of the compressor is always at optimum level regardless of the charge, so that the ratio between the discharge pressure (P_d) and the suction pressure (P_s) is optimum as in the following graphic:

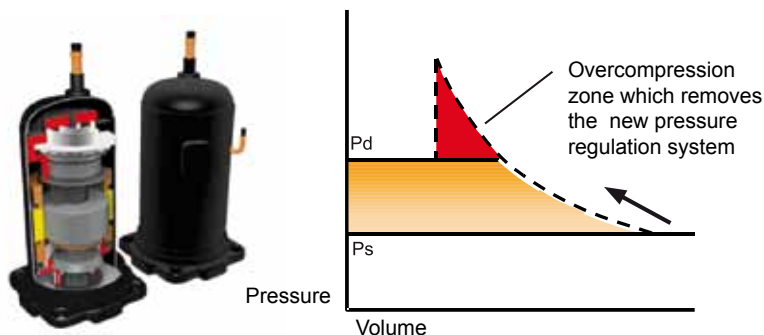

Lubrication

Bearing in mind that lubrication is one of the most important factors in the service life of a compressor, HITACHI has developed a system based on the pressure differences between the suction and discharge using a secondary pump at the base of the compressor. As a result, all of the compressor’s moving parts are lubricated evenly, ensuring high reliability in terms of its operating range, even at low frequencies.

- A: Suction.
- B: Discharge.
- C: Roller bearing.
- D: Synchronous motor.
- E: Asymmetric scroll.
- F: Oil return pipe.
- G: Sub-ball-bearing structure.
- H: Trochoid oil pump.

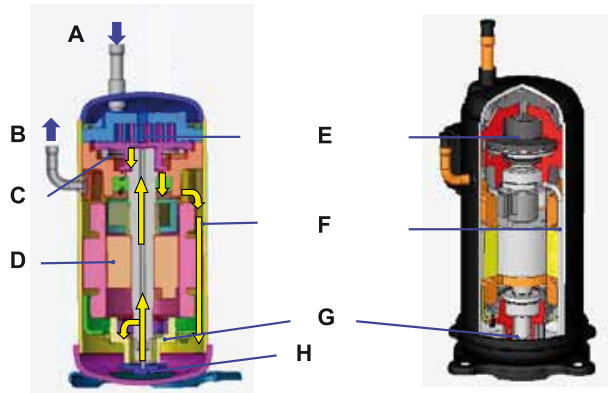

Protection against liquid return

When the compressor is at rest, the moving scroll rests on the casing. When the compressor starts to run, the pressure in the chamber under the scroll builds up through two bleed holes in the medium pressure section of the compression stroke. This pressure then forces the scroll up against the housing and seals the compression chamber. If liquid returns to the compressor, the resulting increase in pressure forces the scroll downwards, breaking the seal and allowing the liquid to pass back into the compressor body, where it will boil off due to the higher temperature.

- A: Suction inlet.
- B: Gas outlet.
- C: Fixed scroll.
- D: Moving scroll.
- E: Housing.
- F: Medium pressure chamber.
- G: “Oldham ring”
- H: Shaft.
- I: Oilway.

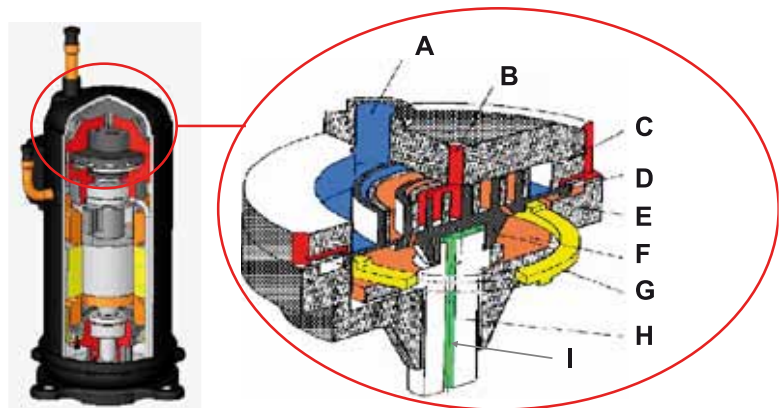

Efficient design of stator coils

The new design of the stator coils positioned to optimize the magnetic field significantly reduce heat losses, and increase the motor’s efficiency at low speeds.

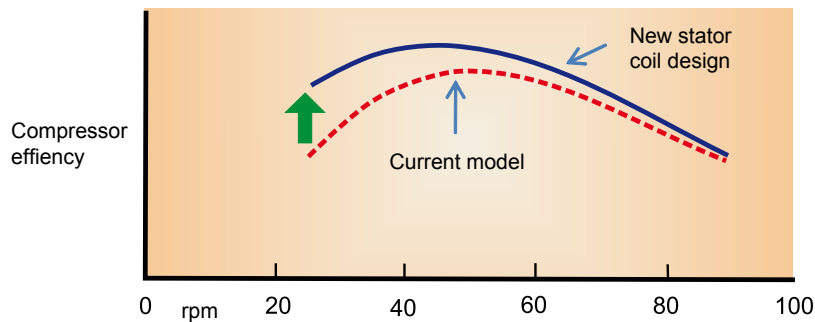

DC compressor with neodymium magnet

The use of a DC compressor with neodymium magnets in the rotor improves the performance at around the 30-40 Hz range where the operation time of the inverter compressor is longest. Additionally, to suppress electromagnetic noise interference and achieve low noise, the rotor has been divided into two parts and the electric pole displaced.

Characteristics at low speed, which affect the annual running cost, have been significantly improved.

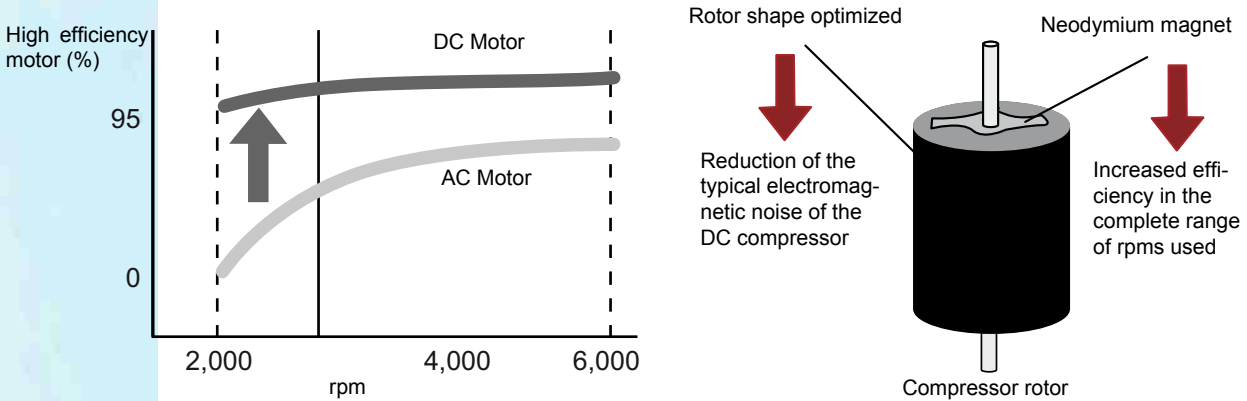

Low noise

- Inverter control: The inverter controls compressor speeds from 30 Hz to 115 Hz, quickly reaching the set temperature and maintaining a stable energy-saving operation, thus reducing the noise since the compressor is not running continuously.

Setting temperature (in heating mode)



- - In the case of UTOPIA series: Quickly reaches the temperature set at high power, then maintains stable energy-saving operation.
- - In the case of other constant speed machines: Slowly reaches the set temperature, then turns on and off repeatedly to maintain the temperature, operating uneconomically and wasting energy.

Power consumption (in heating mode)

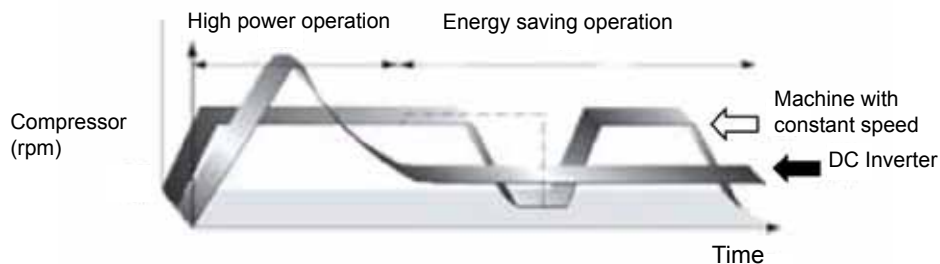

- - In case of existing machines with constant speed, repeated turning on and off wastes energy.

- Optimized rotor shape: The scroll compressor allows reduced noise and vibration levels due to:
 - - The compression points are evenly distributed along the compression stroke.
 - - The reduced number of components used.
 - - Use of a high-pressure insulation shell.

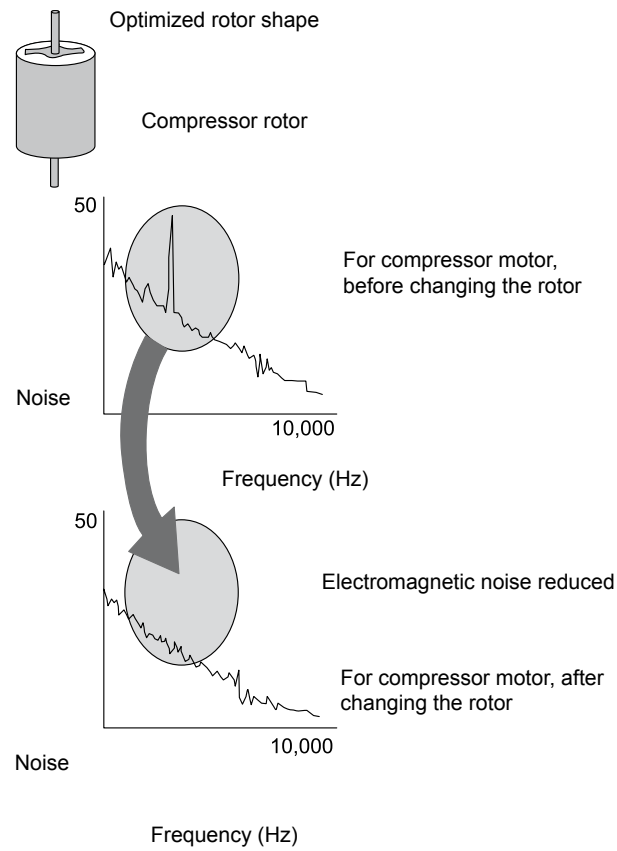

- Acoustically insulated compressor: The scroll compressor is insulated by means of a acoustic cover, providing minimum noise levels.



◆ Large range of operating possibilities

The use of these machines together with CSNET-WEB can increase the performance of these installations even more by:

- Scheduled programming, which prevents these machines from running continuously in rooms which are not being used, and allows rooms to be preheated or pre-refrigerated just before being occupied.
- Limiting the set temperatures, which means that machines do not work at maximum capacity when comfort does not require it.
- Locking functions from the central control, thus avoiding incorrect or ineffective use of the units.

All these and many more functions mean that the use of the installation as a whole can be optimized. And it is worth remembering that because of the wide range of indoor units you can always find the unit with the power and type of installation that best suits your needs. CS-NET-WEB Ability to lock functions from the central control.



2.5 Maintenance benefits

2.5.1 Minimum maintenance

The units have been designed in line with Hitachi's philosophy, guaranteeing great reliability and robustness and reducing maintenance to a minimum.

2.5.2 Easy accessibility

The system components are easily accessible. You can access all of the unit's components to perform any necessary operations through a simple cover. The entire system is designed for maintenance operations to be easy and simple.

2.5.3 Alarm codes

The alarms are grouped by elements within the system in order to facilitate maintenance work and optimize the fitter's job.



2.5.4 SMS alarm

The alarm signals can also be received through a simple SMS specifying the cycle affected and the alarm code, allowing incidents to be detected and solved more quickly.



2.5.5 Availability of maintenance tools

All the functions of the Hitachi Service Tools for setup are applicable to unit maintenance, both preventive and corrective, so that any problem can be detected and solved immediately.

CSNET-WEB is also useful for maintenance tasks.



3. General data

Index

3.1. General data.....	34
3.1.1. General conditions.....	34
3.1.2. RAS-4FS(V)N(Y)2E.....	35
3.1.3. RAS-5FS(V)N(Y)2E.....	36
3.1.4. RAS-6FS(V)N(Y)2E.....	37
3.2. Component data.....	38
3.2.1. RAS-(4-6)FSVN2E.....	38
3.2.2. RAS-(4-6)FSNY2E.....	38
3.2.3. Compressors.....	39
3.3. Electrical data.....	40
3.3.1. Considerations.....	40
3.3.2. RAS-(4-6)FS(V)N(Y)2E.....	40

3

3.1 General data

3.1.1 General conditions

- 1 The heating and cooling capacities indicated refer to the outdoor unit operating with the indoor units at 100% of their capacity, and are based on Standard EN14511.

Operating conditions		Cooling	Heating
Indoor air inlet temperature	DB	27.0 °C	20.0 °C
	WB	19.0 °C	—
Outdoor air inlet temperature	DB	35.0 °C	7.0 °C
	WB	—	6.0 °C

DB: dry bulb; WB: wet bulb.
 Pipe length: 7.5 m; pipe height: 0 m

- 2 The sound pressure level was measured in an anechoic chamber, so reflected sound should be taken into consideration when installing the unit. Test were carried out under the following conditions.
- Measurement point located: 1 m from the surface of the unit's service cover and 1.5 m from floor level.
 - Units working with their nominal power supply.
- 3 The ERR and COP have been calculated with outdoor input power only.

3.1.2 RAS-4FS(V)N(Y)2E

Item	Units	RAS-4FSVN2E	RAS-4FSNY2E
Minimum - Maximum indoor units connectable	-	1 - 6	1 - 6
Minimum - Maximum connected capacity	%	50 - 130	50 - 130
Nominal cooling capacity (min - max)	kW	11.2 (5.60 - 11.2)	11.2 (5.60 - 11.2)
Nominal heating capacity (min - max)	kW	12.5 (6.30 - 12.5)	12.5 (6.30 - 12.5)
Nominal cooling power input	kW	2.75	2.72
Nominal heating power input	kW	3.03	3.00
EER / COP (*1)	-	4.07 / 4.13	4.12 / 4.17
Seasonal EER / COP	-	not available	not available
Energy class (cooling / heating)	-	A / A	A / A
Noise level cooling (sound pressure) (night mode)	dB(A)	49 (45)	49 (45)
Noise level heating (sound pressure)	dB(A)	51	51
Air flow (cooling / heating)	m ³ /min	90 / 90	90 / 90
Dimensions (H x W x D)	mm	1380 / 950 / 370	1380 / 950 / 370
Net weight	kg	100	102
Gross weight	kg	113	115
Power supply	-	1~ 230V 50Hz	3N~ 400V 50Hz
Recommended fuse size	A	32	20
Starting current	A	Less than maximum current	Less than maximum current
Maximum current	A	26	13
Running current cooling	A	12.2	4.1
Running current heating	A	13.4	4.6
Power cable size (according to EN 60335-1)	quantity x mm ²	3 x 6.0	5 x 4.0
Transmitting cable size between indoor unit and outdoor unit	quantity x mm ²	2 x 0.75	2 x 0.75
Piping diameter (liquid / gas)	mm (inch)	Ø9.53 (3/8) / Ø15.88 (5/8)	Ø9.53 (3/8) / Ø15.88 (5/8)
Refrigerant charge before shipment	kg	3.6	3.6
Maximum piping length (additional refrigerant charge needed)	m (g/m)	75 (need to be calculated)	75 (need to be calculated)
Height difference (O.U. higher / O.U. lower)	m	30 / 30	30 / 30
Working range (cooling // heating)	°C	-5 / +46 (DB) // -20 / +15(WB)	-5 / +46 (DB) // -20 / +15(WB)
Refrigerant	-	R410A	R410A
Compressor type	-	Scroll DC Inverter driven	Scroll DC Inverter driven

(*1) Calculated with outdoor input only.

3.1.3 RAS-5FS(V)N(Y)2E

Item	Units	RAS-5FSVN2E	RAS-5FSNY2E
Minimum - Maximum indoor units connectable	-	1 - 8	1 - 8
Minimum - Maximum connected capacity	%	50 - 130	50 - 130
Nominal cooling capacity (min - max)	kW	14.0 (7.00 - 14.0)	14.0 (7.00 - 14.0)
Nominal heating capacity (min - max)	kW	16.0 (8.00 - 16.0)	16.0 (8.00 - 16.0)
Nominal cooling power input	kW	3.88	3.84
Nominal heating power input	kW	4.20	4.16
EER / COP (*1)	-	3.61 / 3.81	3.65 / 3.85
Seasonal EER / COP	-	not available	not available
Energy class (cooling / heating)	-	A / A	A / A
Noise level cooling (sound pressure) (night mode)	dB(A)	51 (47)	51 (47)
Noise level heating (sound pressure)	dB(A)	53	53
Air flow (cooling / heating)	m ³ /min	90 / 90	90 / 90
Dimensions (H x W x D)	mm	1380 / 950 / 370	1380 / 950 / 370
Net weight	kg	100	102
Gross weight	kg	113	115
Power supply	-	1~ 230V 50Hz	3N~ 400V 50Hz
Recommended fuse size	A	32	20
Starting current	A	Less than maximum current	Less than maximum current
Maximum current	A	26	13
Running current cooling	A	17.2	5.8
Running current heating	A	18.6	6.3
Power cable size (according to EN 60335-1)	quantity x mm ²	3 x 6.0	5 x 4.0
Transmitting cable size between indoor unit and outdoor unit	quantity x mm ²	2 x 0.75	2 x 0.75
Piping diameter (liquid / gas)	mm (inch)	Ø9.53 (3/8) / Ø15.88 (5/8)	Ø9.53 (3/8) / Ø15.88 (5/8)
Refrigerant charge before shipment	kg	3.6	3.6
Maximum piping length (additional refrigerant charge needed)	m (g/m)	75 (need to be calculated)	75 (need to be calculated)
Height difference (O.U. higher / O.U. lower)	m	30 / 30	30 / 30
Working range (cooling // heating)	°C	-5 / +46 (DB) // -20 / +15(WB)	-5 / +46 (DB) // -20 / +15(WB)
Refrigerant	-	R410A	R410A
Compressor type	-	Scroll DC Inverter driven	Scroll DC Inverter driven

(*1) Calculated with outdoor input only.

3.1.4 RAS-6FS(V)N(Y)2E

Item	Units	RAS-6FSVN2E	RAS-6FSNY2E
Minimum - Maximum indoor units connectable	-	1 - 9	1 - 9
Minimum - Maximum connected capacity	%	50 - 130	50 - 130
Nominal cooling capacity (min - max)	kW	15.5 (7.80 - 15.5)	15.5 (7.80 - 15.5)
Nominal heating capacity (min - max)	kW	18.0 (9.00 - 18.0)	18.0 (9.00 - 18.0)
Nominal cooling power input	kW	4.67	4.62
Nominal heating power input	kW	4.90	4.85
EER / COP (*1)	-	3.32 / 3.67	3.35 / 3.71
Seasonal EER / COP	-	not available	not available
Energy class (cooling / heating)	-	A / A	A / A
Noise level cooling (sound pressure) (night mode)	dB(A)	51 (48)	51 (48)
Noise level heating (sound pressure)	dB(A)	53	53
Air flow (cooling / heating)	m ³ /min	100 / 100	100 / 100
Dimensions (H x W x D)	mm	1380 / 950 / 370	1380 / 950 / 370
Net weight	kg	100	102
Gross weight	kg	113	115
Power supply	-	1~ 230V 50Hz	3N~ 400V 50Hz
Recommended fuse size	A	32	20
Starting current	A	Less than maximum current	Less than maximum current
Maximum current	A	26	13
Running current cooling	A	20.7	7.0
Running current heating	A	21.7	7.4
Power cable size (according to EN 60335-1)	quantity x mm ²	3 x 6.0	5 x 4.0
Transmitting cable size between indoor unit and outdoor unit	quantity x mm ²	2 x 0.75	2 x 0.75
Piping diameter (liquid / gas)	mm (inch)	Ø9.53 (3/8) / Ø15.88 (5/8)	Ø9.53 (3/8) / Ø15.88 (5/8)
Refrigerant charge before shipment	kg	3.6	3.6
Maximum piping length (additional refrigerant charge needed)	m (g/m)	75 (need to be calculated)	75 (need to be calculated)
Height difference (O.U. higher / O.U. lower)	m	30 / 30	30 / 30
Working range (cooling // heating)	°C	-5 / +46 (DB) // -20 / +15(WB)	-5 / +46 (DB) // -20 / +15(WB)
Refrigerant	-	R410A	R410A
Compressor type	-	Scroll DC Inverter driven	Scroll DC Inverter driven

(*1) Calculated with outdoor input only.

3.2 Component data

3.2.1 RAS-(4-6)FSVN2E

Model		RAS-4FSVN2E	RAS-5FSVN2E	RAS-6FSVN2E	
Heat exchanger	Type	Multi-pass cross-finned tube			
	Pipe material	Copper			
	Outer diameter	mm	7	7	7
	Rows of tubes		2	2	2
	No. of tubes in the Heat exchanger		132	132	132
	Fin material	Aluminium			
	Fin pitch		1.9	1.9	1.9
	Maximum operating pressure	MPa	4.15	4.15	4.15
	Total front area	m ²	1.35	1.35	1.35
	No. of Heat exchanger per unit		1	1	1
Fan	Fan type	Multi-blade turbo fan			
	Fans per unit		2	2	2
	Outer diameter	mm	544	544	544
	Revolutions	rpm	516+422	516+422	573+469
	Nominal air flow	m ³ /min	90	90	100
Motor	Shell	Drip-proof enclosure			
	Starting	Direct current control			
	Power	W	74+74	74+74	74+74
	Quantity		2	2	2
	Insulation class		E	E	E
Compressor		E400HHD-36A2			

3.2.2 RAS-(4-6)FSNY2E

Model		RAS-4FSNY2E	RAS-5FSNY2E	RAS-6FSNY2E	
Heat exchanger	Type	Multi-pass cross-finned tube			
	Pipe material	Copper			
	Outer diameter	mm	7	7	7
	Rows of tubes		2	2	2
	No. of tubes in the Heat exchanger		132	132	132
	Fin material	Aluminium			
	Fin pitch		1.9	1.9	1.9
	Maximum operating pressure	MPa	4.15	4.15	4.15
	Total front area	m ²	1.35	1.35	1.35
	No. of Heat exchanger per unit		1	1	1
Fan	Fan type	Multi-blade turbo fan			
	Fans per unit		2	2	2
	Outer diameter	mm	544	544	544
	Revolutions	rpm	516+422	516+422	573+469
	Nominal air flow	m ³ /min	90	90	100
Motor	Shell	Drip-proof enclosure			
	Starting	Direct current control			
	Power	W	74+74	74+74	74+74
	Quantity		2	2	2
	Insulation class		E	E	E
Compressor		E400HHD-36D2			

3.2.3 Compressors

Model		E400HHD-36(A/D)2	
Compressor	Type	Hermetic scroll	
Pressure resistance	Discharge	MPa	4.15
	Suction	MPa	2.21
Motor type	Starting method		Inverter-driven (I.D)
	Poles		4
	Insulation class		E
Oil	Type		FVC68D
	Quantity	L	1.2

3

3.3 Electrical data

3.3.1 Considerations

Keywords:

- U: Power supply.
- PH: Phase.
- f: Frequency.
- STC: Starting current: Less than maximum current.
- IPT: Total input power.
- RNC: Running current.
- MC: Maximum current.



NOTE

- *The compressor data shown in the table above are based on a combined capacity of 100% of the power supplied.*
- *The data are based on an equivalent piping length of 7.5m and 0m piping lift.*
- *Cooling conditions: Indoor air inlet: 20 °C DB; Outdoor air inlet: 7/6 °C (DB/WB).*
- *Heating conditions: Indoor air inlet: 27/19 °C (DB/WB); Outdoor air inlet: 35 °C DB.*
- *Specifications in these tables are subject to change without notice in order that HITACHI may bring the latest innovations to their customers.*

3.3.2 RAS-(4-6)FS(V)N(Y)2E

Model	Main unit power			Applicable voltage		Compressor and fan motor				MC (A)	
	U (V)	PH	f (Hz)	U max (V)	U min (V)	STC (A)	Cooling operation		Heating operation		
							IPT (kW)	RNC (A)	IPT (kW)		RNC (A)
RAS-4FSVN2E	230	1	50	253	207	-	2.75	12.2	3.03	13.4	26.0
RAS-5FSVN2E	230	1	50	253	207	-	3.88	17.2	4.20	18.6	26.0
RAS-6FSVN2E	230	1	50	253	207	-	4.67	20.7	4.90	21.7	26.0
RAS-4FSNY2E	400	3	50	440	360	-	2.72	4.1	3.00	4.6	13.0
RAS-5FSNY2E	400	3	50	440	360	-	3.84	5.8	4.16	6.3	13.0
RAS-6FSNY2E	400	3	50	440	360	-	4.62	7.0	4.85	7.4	13.0

4. Capacities and selection data

Index

4.1. System selection procedure	42
4.1.1. SET FREE MINI system possibilities	42
4.1.2. Selection parameters.....	45
4.1.3. Selection procedure.....	45
4.2. Cooling capacity tables	51
4.2.1. Cooling capacity curve	51
4.2.2. Nominal cooling capacity tables	52
4.2.3. Cooling capacity tables according to total power of combined indoor units	53
4.3. Heating capacity tables	68
4.3.1. Heating capacity curve	68
4.3.2. Nominal heating capacity tables.....	69
4.3.3. Heating capacity tables according to total power of combined indoor units	70
4.4. Correction factors.....	86
4.4.1. Piping length correction factor.....	86
4.4.2. Defrost correction factor	89
4.4.3. Correction ratio due to humidity (CR).....	89

4

4.1 System selection procedure

The following procedure is an example of how to select the system units and indicates how to use all the parameters indicated in this chapter.

Considering the layout of the building, the possible position of the indoor units and the air flow distribution, select the unit features that provide the greatest efficiency and comfort. Decide a position for the outdoor unit that facilitates service and maintenance tasks, as well as easy refrigerant pipe installation.

4.1.1 SET FREE MINI system possibilities

Before selecting the outdoor unit, it's necessary to take into account some important possibilities that offers the SET-FREE system.

◆ Reduced outdoor unit capacity

First of all, it will be considered the possibility of the "Reduced total outdoor unit capacity as a result of the wide range of operation capacity control available" in the SET-FREE systems, which enable at the outdoor unit to choose a maximum total combination horsepower of 130% and a minimum total combination horsepower of 50% by combination of the indoor units when compared with the nominal outdoor unit capacity. The possibilities of FSN2 series are shown in the following table:

Outdoor unit	Indoor unit				
	Minimum nominal combination capacity (HP)	Maximum nominal combination capacity (HP)	Minimum combination quantity of indoor units	Maximum combination quantity of indoor units	Minimum single operation capacity (HP)
RAS-4FS(V)N(Y)2E	2.0	5.2	1	6	0.8
RAS-5FS(V)N(Y)2E	2.5	6.5	1	8	0.8
RAS-6FS(V)N(Y)2E	3.0	7.8	1	9	0.8



NOTE

The following conditions should be complied when the 5HP and 6HP outdoor units are connected with 8 or 9 indoor units:

- **The capacity of simultaneously operated indoor unit should be less than that of outdoor unit.**
- **When heating, the outdoor temperature should be higher than -5°C.**
- **The maximum piping length (actual length) should be less than 40m; the distance from all multi-kits to indoor unit should be less than 5m.**

This concept allows the outdoor unit to be up to 50% smaller capacity when compared with other air conditioning systems, in case of the total combination horsepower of 130%. This possibility is shown in the following example:

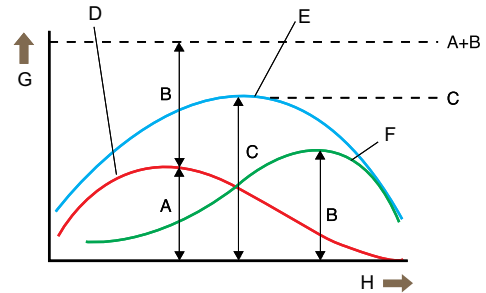
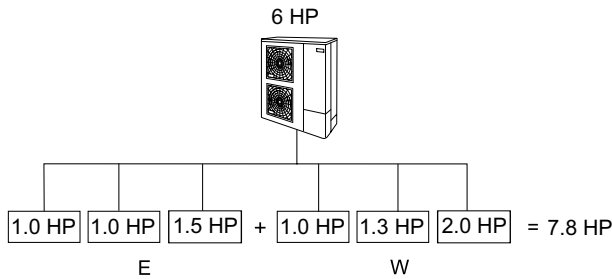

Indoor unit capacity
E: East zone (3.5 HP)
W: West zone (4.3 HP)

A: morning peak heat load in the eastern area
B: evening peak heat load in the western area
C: maximum simultaneous load for the entire building
D: eastern area load
E: total load
F: western area load
G: load
H: time



The diagram shows a typical building with a morning peak heat load on the east zone equivalent to a 3.5 HP unit. In the afternoon a peak occurs on the west zone equivalent to a 4.3 HP unit.

Therefore, a conventional system would require total installed plant of 3.5 HP + 4.3 HP = 7.8 HP. The maximum simultaneous load on the whole building occurs at noon and is equal to 6 HP of unit capacity. A SET-FREE mini FS(V)N(Y)2E system of 6 HP can be selected, and this capacity can be directed either to the east or west zone as dictated by the system controls.

i NOTE

- **The maximum required loads of east and west zone must not be simultaneous.**
- **For the system which all indoors are operated simultaneously, the total indoor capacity should be less or equal to the outdoor unit capacity. If not, poor performance or narrow operation range at overload may occur.**

The total combination horsepower is calculated with the following formula:

$$\begin{aligned} \text{Total combination horsepower} &= (\text{Total indoor unit horsepower} / \text{Outdoor unit horsepower}) \times 100 \\ &= (7.8 \text{ HP} / 6 \text{ HP}) \times 100 = 130\% \end{aligned}$$

◆ **Capacity adjustment by dip switch setting of the indoor units**

In some, situations, it should be useful to adjust the capacity of the indoor units in order to adapt the unit to the actual installation requirements. This function is performed by dip switch setting and it's possible in some HP indoor unit models.

Following table contains the nominal capacity and the adjusted capacity by dip switch setting of the indoor units.

Nominal capacity of indoor units

Indoor units (HP)	0.8	1.0	1.5	2.0	2.5	3.0	4.0	5.0	6.0
Cooling (kW)	2.2	2.8	4.0	5.6	7.1	8.0	11.2	14.0	16.0
Heating (kW)	2.5	3.2	4.8	6.3	8.5	9.0	12.5	16.0	18.0

i NOTE

The nominal cooling and heating capacity is the combined capacity of the SET FREE system, and is based on EN14511.

Operation condition		Cooling	Heating
Indoor air inlet temperature	DB	27 °C	20 °C
	WB	19 °C	—
Outdoor air inlet temperature	DB	35 °C	7 °C
	WB	—	6 °C





Piping length: 7.5 meters.

Piping height: 0 meters.

DB: Dry Bulb.

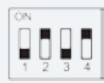
WB: Wet Bulb.

Adjusted capacities of indoor units

Horsepower (HP)	1.3		1.8		2.3				
Variable capacity(HP)	1.5	→	1.3	2.0	→	1.8	2.5	→	2.3
Cooling (kW)	3.8		5.2		6.7				
Heating (kW)	4.2		5.6		7.5				
Applicable model	RPI(M), RCI(M), RCD, RPK, RPF, RPF1		RPI, RCI, RCD, RPK, RPC		RPI, RCI, RCD, RPC				
Indoor unit dip switch setting (DSW3)		→		→		→		→	
	Factory setting		Adjusted power	Factory setting	Adjusted power	Factory setting	Adjusted power		

i NOTE

The maximum indoor unit capacity combined with the capacity of the outdoor unit should be carefully considered to ensure the correct distribution of the indoor units in each building.

4.1.2 Selection parameters

To select the outdoor units, it will be necessary to consult and/or use a serie of parameters shown in tables and graphics presented in the different chapters of this catalogue. A summarized list is shown below:

Available models	Cooling and heating capacities
General information of the units	COP and EER
Operation space possibilities	Different correction factors
Working range	Sound data for the different units

In case of an installation with ducts (outdoor unit with RPI indoor unit) the fan performance for duct calculations should be considered. The RPI units are designed with different static pressure ranges in order to fulfil all installation necessities.

4.1.3 Selection procedure

Once considered the SET-FREE system possibilities, it's the moment to start with the selection procedure. In order to do this, it has been assumed an installation consisting of several rooms with differents required cooling loads and temperature conditions, which are shown below:

◆ Design conditions

Temperature condition

Cooling	Heating
Outdoor air inlet temperature: 35 °C DB	Outdoor air inlet temperature: 5/1 °C (DB/WB)
Indoor air inlet temperature: 25/17 °C (DB/WB)	Indoor air inlet temperature: 18 °C DB

Installation required loads (*)

Item			East zone		West zone
			Room 1	Room 2	Room 3
Estimated cooling load	Total	kW	2.60	3.80	4.60
	Sensible		1.90	2.70	3.40
Estimated heating load	Total	kW	2.80	4.20	5.00



NOTE

(*) *In this example, the maximum required loads will not be simultaneous.*

- *The maximum required loads of rooms 1 and 2 (east zone) occurs at the morning*
- *The maximum required load of room 3 (west zone) occurs at the afternoon.*

Installation characteristics

Power supply	1~ 230V 50Hz
Equivalent piping length (L)	50 m
Height difference between outdoor unit and indoor units (H)	+20 m

It has been considered that the outdoor unit is located in a higher position than the indoor units. Therefore, when necessary refer to the section "Piping length correction factor", it will be used the correction factor value at positive height difference between indoor and outdoor units (+H).

◆ **Step 1: Initial pre-selection**

Taking into account the SET-FREE system possibilities mentioned above, it has been adjusted the indoor unit capacities by dip-switch (DSW3).

Item		Room 1	Room 2	Room 3	1+2+3	Outdoor unit
Selected model		RPIM-1.5 (Adjusted to 1.3)	RCD-2.0	RCI-2.5 (Adjusted to 2.3)	5.6 HP	RAS-5FSVN2E (112%)
Nominal cooling capacity	kW	3.8	5.6	6.7	16.1	13.02
Nominal heating capacity		4.2	6.3	7.5	18.0	14.30

The pre-selected capacity of the different indoor units has not been the immediately higher in order to apply a safety factor considering the different correction factors existing, which will reduce the capacity.

To determinate the nominal cooling and heating capacity, it's necessary refer to sections "Cooling and Heating capacity tables according to total power of combined indoor units" respectively, taking into account the temperature condition and the total power of combined indoor units (112%).

i **NOTE**

- **In this case, the total power of combined indoor units is not shown in the capacity tables (112%), then an interpolation should be carried out using the values above and below (120% and 110%) those of the total power of combined indoor units.**
- **If the air inlet temperature for the indoor unit or outdoor unit is not contained in the capacity tables, an interpolation should be carried out using the values above and below those of the air inlet temperature.**

Then, it's shown a diagram of the installation resulting:

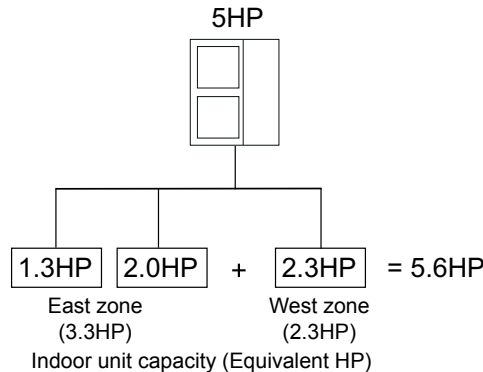

For this example it has been assumed three different indoor units (RPK-1.5FSN2E, RCD-2.0FSN2 and RCI-2.5FSN3E) in order to show how the choice of indoor unit can affect the different factors presented in this chapter.

The resulting total indoor unit horsepower is 5.6 HP. The outdoor unit with the horsepower immediately higher is the 6 HP model, but the possibility "Reduced total outdoor unit capacity" allows the 5 HP model selection. Thus, it's allowed at the outdoor unit to be up to 12% smaller capacity when compared with other air conditioning systems.

The total combination horsepower is the following:

$$\text{Total combination horsepower} = \frac{\text{Total indoor unit horsepower}}{\text{Outdoor unit horsepower}} \times 100 = \frac{5.6 \text{ HP}}{5.0 \text{ HP}} \times 100 = 112 \%$$

Next step will be the capacity correction using the different correction factors shown in this chapter.

This procedure is divided in two parts: cooling and heating.

Cooling mode

◆ Step 2: Cooling capacity correction

The actual cooling capacity of the pre-selected outdoor unit must be calculated applying the necessary correction factors:

$$Q_C = Q_{MC} \times f_{LC}$$

Q_C : Actual cooling capacity of the outdoor unit (kW).

Q_{MC} : Maximum cooling capacity of the outdoor unit (kW).

f_{LC} : Cooling piping length correction factor.

The maximum cooling capacity (Q_{MC}) of the RAS-5FSVN2E unit is 13.02 kW.

Calculation of f_{LC} :

Both length of the refrigerant piping used and height difference between the outdoor unit and the indoor units directly affect the performance of the unit. This concept is quantified in the piping length correction factor.

To determine this value it is necessary refer to section "Piping length correction factor", where it can be seen that for the characteristics of our example (piping length of 50 metres and a height difference between the outdoor unit and the indoor units of +20 metres) the piping length correction factor for cooling mode is **0.89** approximately.

Calculation of Q_C :

Once the correction factors to be applied have been determined, the formula for the corrected cooling capacity by piping length of the unit RAS-5FSVN2E can be applied:

$$Q_C = 13.02 \text{ kW} \times 0.89 = 11.59 \text{ kW}$$

Actual cooling capacity of the outdoor unit (Q_{AC}):

The cooling capacity data for the RAS-5FSVN2E unit taken from the table in section "Nominal cooling capacity tables" is calculated on the basis of a relative humidity of 50% which means that an indoor air inlet temperature of 17 °C WB corresponds to a temperature of 24 °C DB.

However, the difference between the indoor air inlet dry bulb temperature required by the system (25 °C) and the indoor air inlet dry bulb temperature recorded in the cooling capacity data (24 °C) requires an adjustment of the capacity.

The following formula is used to apply this adjustment.

$$Q_{AC} = Q_C + (CR \times (DB_R - DB))$$

Q_{AC} : Actual cooling capacity of the outdoor unit (kW).

Q_C : Corrected cooling capacity of the outdoor unit by piping length (kW)

CR : Correction ratio due to humidity.

DB_R : Real Dry Bulb evaporator temperature (°C).

DB : Dry Bulb evaporator temperature (°C) for each wet bulb temperature from the table (HR = 50 %).

Calculation of CR :

The correction ratio due to humidity is shown in a table contained in section "Correction ratio due to humidity (CR)".

This coefficient corrects the sensible heat capacity of a unit according to the relative humidity of the air entering the indoor unit. The greater the relative humidity the lower will be the sensible heat capacity and vice versa.

The correction ratio CR for the RAS-5FSVN2E unit is **0.61**.

Calculation of Q_{AC}

Once the CR has been identified for the RAS-5FSVN2E unit, the actual cooling capacity of the unit RAS-5FSVN2E can be calculated:

$$Q_{AC} = 11.59 \text{ kW} + 0.61 \times (25-24) = \mathbf{12.20 \text{ kW}}$$

◆ Step 3: Cooling capacity of each indoor unit

Once it's known the actual cooling capacity of the outdoor unit, it must be calculated the actual cooling capacity of each indoor unit, according to the following formula:

$$Q_{Ci} = Q_{AC} \times (Q_{MCI} / Q_{MCC})$$

Q_{Ci} : Actual cooling capacity of the indoor unit (kW).

Q_C : Actual cooling capacity of the outdoor unit (kW).

Q_{MCI} : Nominal cooling capacity of the indoor unit (kW).

Q_{MCC} : Nominal cooling capacity of the combination (kW).

Applying this we obtain:

n° 1	RPIM-1.5 (Adjusted to 1.3)	Cooling capacity = $12.20 \times (3.80 / 16.10) = \mathbf{2.88 \text{ kW}}$
n° 2	RCD-2.0	Cooling capacity = $12.20 \times (5.60 / 16.10) = \mathbf{4.24 \text{ kW}}$
n° 3	RCI-2.5 (Adjusted to 2.3)	Cooling capacity = $12.20 \times (6.70 / 16.10) = \mathbf{5.08 \text{ kW}}$

◆ Step 4: Sensible heat capacity (SHC)

The system requirements specify a sensible heat load for each indoor unit.

Once the calculation of the indoor units cooling capacity has been completed, the sensible heat capacity can be calculated using the following formula:

$$SHC = Q_{Ci} \times SHF$$

SHC : Sensible heat capacity (kW)

Q_{Ci} : Actual cooling capacity of the indoor unit (kW)

SHF : Sensible heat factor

Calculation of SHF

To determine the sensible heat factor (ratio of sensible heat relative to the total) the table in section "Sensible heat factor (SHF)" in Indoor units Technical Catalogue has to be seen, in which the different SHF values are shown for the different indoor units for each of the three possible fan speeds (High, Medium, Low). The value used is that relating to the high fan speed. Doing this we obtain:

$$SHF_{RPIM-1.5} = 0.71$$

$$SHF_{RCD-2.0} = 0.75$$

$$SHF_{RCI-2.5} = 0.73$$

Calculation of SHC

Initially, once the sensible heat factors have been obtained, the sensible heat capacity of each indoor unit can be calculated by applying the previous formula.

$SHF_{RPIM-1.5} = 2.88 \text{ kW} \times 0.71 = 2.04 \text{ kW}$
$SHF_{RCD-2.0} = 4.24 \text{ kW} \times 0.75 = 3.18 \text{ kW}$
$SHF_{RCI-2.5} = 5.08 \text{ kW} \times 0.73 = 3.71 \text{ kW}$

The results of cooling mode are the following:

Item			Room 1	Room 2	Room 3	1+2+3	Outdoor unit
Selected model			RPIM-1.5 (Adjusted to 1.3)	RCD-2.0	RCI-2.5 (Adjusted to 2.3)	5.6 HP	RAS-5FSVN2E (112%)
Estimated cooling load	Total	kW	2.60	3.80	4.60	11.00	8.00
	Sensible		1.90	2.70	3.40		
Corrected cooling capacity	Total	kW	2.88	4.24	5.08	12.20	8.93
	Sensible		2.04	3.18	3.71		

As can be seen, the total and sensible corrected cooling capacity are greater than the estimated cooling load by the different rooms to be conditioned. Therefore, it can be said that the RAS-5FSVN2E unit meets the minimum cooling requirements set for the system.

In order to validate the pre-selection of the RAS-5FSVN2E unit, its compliance with the minimum heating requirements must be checked as well.

◆ Heating mode

Referring to the step 1 (Initial pre-selection), it can be seen the nominal heating capacities selected for each room and the outdoor unit capacity at the 112% total combination horsepower, resulting total indoor unit horsepower is 5.6 HP.

Item		Room 1	Room 2	Room 3	1+2+3	Outdoor unit
Selected model		RPIM-1.5 (Adjusted to 1.3)	RCD-2.0	RCI-2.5 (Adjusted to 2.3)	5.6 HP	RAS-5FSVN2E (112%)
Nominal heating capacity	kW	4.2	6.3	7.5	18.00	14.30

◆ Step 5: Heating capacity correction

The actual heating capacity of the pre-selected outdoor unit must be calculated applying the necessary correction factors:

$$Q_{AH} = Q_{MH} \times f_{LH} \times f_D$$

Q_C : Actual heating capacity of the outdoor unit (kW).

Q_{MC} : Maximum heating capacity of the outdoor unit (kW).

f_{LC} : Heating piping length correction factor.

f_D : Defrost correction factor.

The maximum cooling capacity (Q_{MH}) of the RAS-5FSVN2E unit is 14.30 kW.

Calculation of f_{LH}

Referring to the section “Piping length correction factor”, it can be seen that for the characteristics of our example (piping length of 50 metres and a height difference between the outdoor unit and the indoor units of +20 metres) the piping length correction factor for heating mode is **0.96** approximately.

Calculation of f_D

In situations where the ambient temperature is lower than 7 °C DB, frost may build up on the heat exchanger. In that case, the heating capacity for the unit may be reduced because of the time spent by the unit in removing the build-up.

The defrosting correction factor takes this time into account and applies the heating capacity correction.

To calculate the correction factor, please see section “Defrosting correction factor” which shows a table with different values of f_D depending on the ambient temperature (°C DB). If the correction factor at an ambient temperature specified does not appear on the table, an interpolation will be needed.

Finally, the resulting defrosting correction factor is **0.90**.

Calculation of Q_{AH}

Once the correction factors to be applied have been determined, the formula for actual heating capacity of the unit RAS-8FSNM(E) can be applied:

$$Q_H = 14.30 \text{ kW} \times 0.96 \times 0.90 = 12.36 \text{ kW}$$

◆ Step 6: Heating capacity of each indoor unit

Once it's known the actual heating capacity of the outdoor unit, it must be calculated the actual heating capacity of each indoor unit, according to the following formula:

$$Q_{HI} = Q_H \times (Q_{MHI} / Q_{MHC})$$

Q_{HI} : Actual heating capacity of the indoor unit (kW).

Q_{AH} : Actual heating capacity of the outdoor unit (kW)

Q_{MHI} : Nominal heating capacity of the indoor unit (kW).

Q_{MHC} : Nominal heating capacity of the combination (kW).

Applying this we obtain:

n° 1	RPIM-1.5 (Adjusted to 1.3)	Heating capacity = 12.36 x (4.20 / 18.00) = 2.88 kW
n° 2	RCD-2.0	Heating capacity = 12.36 x (6.30 / 18.00) = 4.33 kW
n° 3	RCI-2.5 (Adjusted to 2.3)	Heating capacity = 12.36 x (7.50 / 18.00) = 5.15 kW

The results of heating mode are the following:

Item	Room 1	Room 2	Room 3	1+2+3	Outdoor unit
Selected model	RPIM-1.5 (Adjusted to 1.3)	RCD-2.0	RCI-2.5 (Adjusted to 2.3)	5.6 HP	RAS-5FSVN2E (112%)
Estimated heating load	2.80	4.20	5.00	12.00	
Corrected heating capacity	2.88	4.33	5.15	12.36	

As can be seen, the corrected heating capacity is greater than the estimated heating load by the different rooms to be conditioned. Therefore, it can be said that the RAS-5FSVN2E unit is valid for both heating and cooling.

4.2 Cooling capacity tables

The following tables show the capacity characteristics of the outdoor unit corresponding to the total power of the indoor units combined, in standard conditions with horizontal, 7.5 m long refrigerant pipes.

Temperature conditions	
Indoor air inlet temperature	27 °C DB
	19 °C WB
Outdoor air inlet temperature	35 °C DB



NOTE

DB: dry bulb; WB: wet bulb.

4.2.1 Cooling capacity curve

A: Cooling capacity (kW).

B: Total horsepower of combined indoor units (HP).

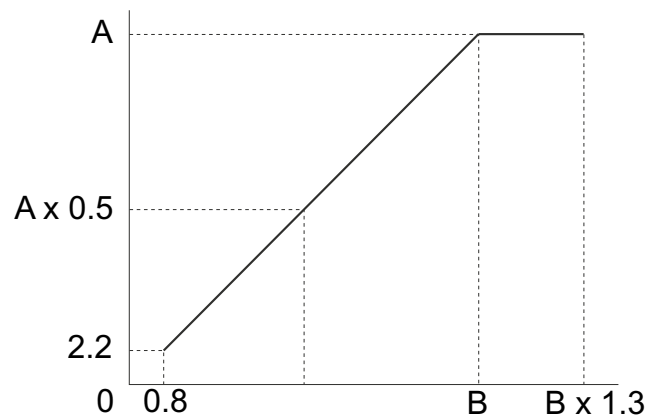

Model	A (kW)	B (HP)
RAS-4FS(V)N(Y)2E	11.2	4
RAS-5FS(V)N(Y)2E	14.0	5
RAS-6FS(V)N(Y)2E	15.5	6

4.2.2 Nominal cooling capacity tables

Cooling capacity at conditions: Indoor air inlet: 27/19 °C (DB/WB); Outdoor air inlet: 35 °C DB.

◆ **RAS-(4-6)FSVN2E**

Total horsepower of combined indoor units (%)	Outdoor units HP					
	RAS-4FSVN2E		RAS-5FSVN2E		RAS-6FSVN2E	
	Cooling capacity (kW)	Cooling input (kW)	Cooling capacity (kW)	Cooling input (kW)	Cooling capacity (kW)	Cooling input (kW)
130	11.20	2.83	14.00	4.00	15.50	4.81
120	11.20	2.81	14.00	4.15	15.50	4.76
110	11.20	2.78	14.00	3.92	15.50	4.72
100	11.20	2.75	14.00	3.88	15.50	4.67
90	10.08	2.39	12.60	3.38	13.95	4.06
80	8.96	2.09	11.20	2.95	12.40	3.55
70	7.84	1.79	9.80	2.52	10.85	3.04
60	6.72	1.51	8.40	2.13	9.30	2.57
50	5.60	1.27	7.00	1.78	7.75	2.15

◆ **RAS-(4-6)FSNY2E**

Total horsepower of combined indoor units (%)	Outdoor units HP					
	RAS-4FSNY2E		RAS-5FSNY2E		RAS-6FSNY2E	
	Cooling capacity (kW)	Cooling input (kW)	Cooling capacity (kW)	Cooling input (kW)	Cooling capacity (kW)	Cooling input (kW)
130	11.20	2.80	14.00	3.96	15.50	4.76
120	11.20	2.77	14.00	3.92	15.50	4.71
110	11.20	2.75	14.00	3.88	15.50	4.67
100	11.20	2.72	14.00	3.84	15.50	4.62
90	10.08	2.37	12.60	3.34	13.95	4.02
80	8.96	2.07	11.20	2.92	12.40	3.51
70	7.84	1.77	9.80	2.50	10.85	3.00
60	6.72	1.50	8.40	2.11	9.30	2.54
50	5.60	1.25	7.00	1.77	7.75	2.13

4.2.3 Cooling capacity tables according to total power of combined indoor units



NOTE

To: Outdoor air inlet temperature DB (°C)

Ti: Indoor air inlet temperature WB (°C) / (DB (°C))

CAP: Capacity at compressor maximum frequency (kW)

IPT: Input power (kW)

◆ **RAS-(4-6)FSVN2E**

RAS-4FSVN2E

To	Total power of combined indoor units (50%)										Total power of combined indoor units (60%)									
	Ti										Ti									
	15/(21)		17/(24)		19/(27)		21/(29)		23/(31)		15/(21)		17/(24)		19/(27)		21/(29)		23/(31)	
	CAP	IPT	CAP	IPT	CAP	IPT	CAP	IPT	CAP	IPT	CAP	IPT	CAP	IPT	CAP	IPT	CAP	IPT	CAP	IPT
10	5.15	0.99	5.54	1.04	5.94	1.10	6.33	1.12	6.72	1.14	6.18	1.19	6.65	1.24	7.12	1.31	7.59	1.34	8.06	1.36
12	5.15	0.99	5.54	1.04	5.94	1.10	6.33	1.13	6.72	1.14	6.18	1.19	6.65	1.24	7.12	1.31	7.59	1.35	8.06	1.36
14	5.15	1.00	5.54	1.04	5.94	1.10	6.33	1.13	6.72	1.14	6.18	1.19	6.65	1.24	7.12	1.32	7.59	1.35	8.06	1.37
16	5.15	1.00	5.54	1.05	5.94	2.39	6.33	1.13	6.72	1.15	6.18	1.20	6.65	1.25	7.12	2.39	7.59	1.36	8.06	1.37
18	5.15	1.01	5.54	1.05	5.94	1.12	6.33	1.14	6.72	1.16	6.18	1.21	6.65	1.26	7.12	1.33	7.59	1.37	8.06	1.39
20	5.15	1.02	5.54	1.07	5.94	1.13	6.33	1.15	6.72	1.17	6.18	1.22	6.65	1.27	7.12	1.35	7.59	1.38	8.06	1.40
22	5.15	1.03	5.54	1.08	5.94	1.14	6.33	1.17	6.72	1.18	6.18	1.23	6.65	1.29	7.12	1.36	7.59	1.40	8.06	1.41
24	5.15	1.04	5.54	1.09	5.94	1.15	6.33	1.18	6.72	1.20	6.18	1.25	6.65	1.31	7.12	1.38	7.59	1.41	8.06	1.43
25	5.15	1.05	5.54	1.10	5.94	1.16	6.33	1.19	6.72	1.21	6.18	1.26	6.65	1.32	7.12	1.39	7.59	1.43	8.06	1.44
26	5.12	1.06	5.51	1.11	5.90	1.17	6.29	1.20	6.70	1.21	6.14	1.26	6.61	1.32	7.08	1.40	7.55	1.43	8.04	1.45
28	5.05	1.07	5.44	1.12	5.84	1.18	6.23	1.21	6.65	1.22	6.06	1.28	6.53	1.33	7.00	1.41	7.47	1.44	7.98	1.46
30	4.98	1.08	5.38	1.13	5.77	1.19	6.16	1.22	6.61	1.23	5.98	1.29	6.45	1.35	6.92	1.42	7.39	1.46	7.93	1.47
32	4.92	1.11	5.31	1.16	5.70	1.22	6.09	1.25	6.52	1.26	5.90	1.32	6.37	1.38	6.84	1.46	7.31	1.49	7.82	1.51
34	4.85	1.14	5.24	1.19	5.63	1.25	6.03	1.28	6.43	1.29	5.82	1.36	6.29	1.42	6.76	1.49	7.23	1.53	7.71	1.55
35	4.82	1.15	5.21	1.20	5.60	1.27	5.99	1.29	6.38	1.31	5.78	1.38	6.25	1.44	6.72	1.51	7.19	1.55	7.66	1.57
36	4.77	1.19	5.16	1.23	5.56	1.30	5.95	1.33	6.33	1.34	5.73	1.42	6.20	1.48	6.67	1.55	7.14	1.59	7.59	1.61
38	4.68	1.25	5.07	1.30	5.47	1.36	5.86	1.39	6.22	1.41	5.62	1.50	6.09	1.55	6.56	1.63	7.03	1.67	7.46	1.69
40	4.59	1.32	4.98	1.37	5.38	1.43	5.77	1.46	6.10	1.48	5.51	1.57	5.98	1.63	6.45	1.71	6.92	1.75	7.32	1.77

To	Total power of combined indoor units (70%)										Total power of combined indoor units (80%)									
	Ti										Ti									
	15/(21)		17/(24)		19/(27)		21/(29)		23/(31)		15/(21)		17/(24)		19/(27)		21/(29)		23/(31)	
	CAP	IPT	CAP	IPT	CAP	IPT	CAP	IPT	CAP	IPT	CAP	IPT	CAP	IPT	CAP	IPT	CAP	IPT	CAP	IPT
10	7.21	1.40	7.76	1.47	8.31	1.55	8.86	1.59	9.41	1.61	8.24	1.64	8.87	1.71	9.50	1.81	10.12	1.86	10.75	1.88
12	7.21	1.40	7.76	1.47	8.31	1.55	8.86	1.59	9.41	1.61	8.24	1.64	8.87	1.71	9.50	1.82	10.12	1.86	10.75	1.88
14	7.21	1.41	7.76	1.47	8.31	1.56	8.86	1.59	9.41	1.61	8.24	1.65	8.87	1.72	9.50	1.82	10.12	1.86	10.75	1.89
16	7.21	1.42	7.76	1.48	8.31	2.39	8.86	1.60	9.41	1.62	8.24	1.66	8.87	1.73	9.50	2.39	10.12	1.87	10.75	1.90
18	7.21	1.42	7.76	1.49	8.31	1.58	8.86	1.62	9.41	1.64	8.24	1.67	8.87	1.74	9.50	1.84	10.12	1.89	10.75	1.91
20	7.21	1.44	7.76	1.51	8.31	1.59	8.86	1.63	9.41	1.65	8.24	1.68	8.87	1.76	9.50	1.86	10.12	1.91	10.75	1.93
22	7.21	1.46	7.76	1.52	8.31	1.61	8.86	1.65	9.41	1.67	8.24	1.70	8.87	1.78	9.50	1.88	10.12	1.93	10.75	1.95
24	7.21	1.48	7.76	1.54	8.31	1.63	8.86	1.67	9.41	1.69	8.24	1.73	8.87	1.80	9.50	1.91	10.12	1.95	10.75	1.98
25	7.21	1.49	7.76	1.56	8.31	1.64	8.86	1.68	9.41	1.71	8.24	1.74	8.87	1.82	9.50	1.92	10.12	1.97	10.75	2.00
26	7.17	1.49	7.71	1.56	8.26	1.65	8.81	1.69	9.38	1.71	8.19	1.75	8.82	1.83	9.44	1.93	10.07	1.98	10.72	2.00
28	7.07	1.51	7.62	1.58	8.17	1.67	8.72	1.71	9.31	1.73	8.08	1.77	8.71	1.84	9.34	1.95	9.96	1.99	10.64	2.02
30	6.98	1.52	7.53	1.59	8.08	1.68	8.62	1.72	9.25	1.74	7.97	1.78	8.60	1.86	9.23	1.96	9.86	2.01	10.57	2.04
32	6.88	1.57	7.43	1.63	7.98	1.72	8.53	1.76	9.13	1.79	7.87	1.83	8.49	1.91	9.12	2.01	9.75	2.06	10.43	2.09
34	6.79	1.61	7.34	1.68	7.89	1.77	8.44	1.81	9.00	1.83	7.76	1.88	8.39	1.96	9.01	2.06	9.64	2.11	10.29	2.14
35	6.74	1.63	7.29	1.70	7.84	1.79	8.39	1.83	8.94	1.85	7.71	1.91	8.33	1.99	8.96	2.09	9.59	2.14	10.21	2.16
36	6.68	1.68	7.23	1.74	7.78	1.83	8.33	1.88	8.86	1.90	7.63	1.96	8.26	2.04	8.89	2.14	9.52	2.19	10.12	2.22
38	6.55	1.77	7.10	1.84	7.65	1.93	8.20	1.97	8.70	2.00	7.49	2.07	8.12	2.15	8.74	2.25	9.37	2.30	9.95	2.33
40	6.43	1.86	6.98	1.93	7.53	2.02	8.08	2.06	8.55	2.09	7.35	2.17	7.97	2.26	8.60	2.36	9.23	2.41	9.77	2.45

4

To	Total power of combined indoor units (90%)										Total power of combined indoor units (100%)									
	Ti										Ti									
	15/(21)		17/(24)		19/(27)		21/(29)		23/(31)		15/(21)		17/(24)		19/(27)		21/(29)		23/(31)	
	CAP	IPT	CAP	IPT	CAP	IPT	CAP	IPT	CAP	IPT	CAP	IPT	CAP	IPT	CAP	IPT	CAP	IPT	CAP	IPT
10	9.27	1.88	9.98	1.96	10.68	2.07	11.39	2.13	12.10	2.15	10.30	2.16	11.09	2.26	11.87	2.38	12.66	2.44	13.44	2.48
12	9.27	1.88	9.98	1.96	10.68	2.08	11.39	2.13	12.10	2.15	10.30	2.16	11.09	2.26	11.87	2.39	12.66	2.45	13.44	2.48
14	9.27	1.88	9.98	1.97	10.68	2.08	11.39	2.13	12.10	2.16	10.30	2.17	11.09	2.26	11.87	2.39	12.66	2.45	13.44	2.48
16	9.27	1.89	9.98	1.98	10.68	2.39	11.39	2.14	12.10	2.17	10.30	2.18	11.09	2.28	11.87	2.39	12.66	2.46	13.44	2.50
18	9.27	1.91	9.98	1.99	10.68	2.11	11.39	2.16	12.10	2.19	10.30	2.19	11.09	2.29	11.87	2.42	12.66	2.49	13.44	2.52
20	9.27	1.93	9.98	2.01	10.68	2.13	11.39	2.18	12.10	2.21	10.30	2.21	11.09	2.32	11.87	2.45	12.66	2.51	13.44	2.54
22	9.27	1.95	9.98	2.04	10.68	2.15	11.39	2.21	12.10	2.24	10.30	2.24	11.09	2.34	11.87	2.47	12.66	2.54	13.44	2.57
24	9.27	1.98	9.98	2.07	10.68	2.18	11.39	2.24	12.10	2.27	10.30	2.27	11.09	2.37	11.87	2.51	12.66	2.57	13.44	2.60
25	9.27	1.99	9.98	2.08	10.68	2.20	11.39	2.25	12.10	2.28	10.30	2.29	11.09	2.39	11.87	2.53	12.66	2.59	13.44	2.63
26	9.21	2.00	9.92	2.09	10.62	2.21	11.33	2.26	12.06	2.29	10.24	2.30	11.02	2.40	11.80	2.54	12.59	2.60	13.40	2.64
28	9.09	2.02	9.80	2.11	10.50	2.23	11.21	2.28	11.98	2.31	10.10	2.32	10.89	2.43	11.67	2.56	12.45	2.62	13.31	2.66
30	8.97	2.04	9.68	2.13	10.38	2.25	11.09	2.30	11.89	2.33	9.97	2.35	10.75	2.45	11.54	2.59	12.32	2.65	13.22	2.68
32	8.85	2.10	9.56	2.19	10.26	2.31	10.97	2.36	11.73	2.39	9.83	2.41	10.62	2.51	11.40	2.65	12.19	2.71	13.04	2.75
34	8.73	2.15	9.43	2.24	10.14	2.36	10.85	2.42	11.57	2.45	9.70	2.47	10.48	2.58	11.27	2.72	12.05	2.78	12.86	2.81
35	8.67	2.18	9.37	2.27	10.08	2.39	10.79	2.45	11.49	2.48	9.63	2.51	10.42	2.61	11.20	2.75	11.98	2.81	12.77	2.85
36	8.59	2.24	9.29	2.34	10.00	2.45	10.70	2.51	11.39	2.54	9.54	2.58	10.33	2.68	11.11	2.82	11.89	2.88	12.66	2.92
38	8.43	2.36	9.13	2.46	9.84	2.58	10.54	2.64	11.19	2.67	9.36	2.72	10.15	2.83	10.93	2.96	11.72	3.03	12.43	3.07
40	8.27	2.49	8.97	2.58	9.68	2.70	10.38	2.76	10.99	2.80	9.18	2.86	9.97	2.97	10.75	3.11	11.54	3.18	12.21	3.22

To	Total power of combined indoor units (110%)										Total power of combined indoor units (120%)									
	Ti										Ti									
	15/(21)		17/(24)		19/(27)		21/(29)		23/(31)		15/(21)		17/(24)		19/(27)		21/(29)		23/(31)	
	CAP	IPT	CAP	IPT	CAP	IPT	CAP	IPT	CAP	IPT	CAP	IPT	CAP	IPT	CAP	IPT	CAP	IPT	CAP	IPT
10	10.30	2.18	11.09	2.28	11.87	2.41	12.66	2.47	13.44	2.50	10.30	2.20	11.09	2.30	11.87	2.43	12.66	2.49	13.44	2.53
12	10.30	2.18	11.09	2.28	11.87	2.41	12.66	2.47	13.44	2.50	10.30	2.20	11.09	2.30	11.87	2.44	12.66	2.49	13.44	2.53
14	10.30	2.19	11.09	2.28	11.87	2.42	12.66	2.48	13.44	2.51	10.30	2.21	11.09	2.31	11.87	2.44	12.66	2.50	13.44	2.53
16	10.30	2.20	11.09	2.30	11.87	2.39	12.66	2.49	13.44	2.52	10.30	2.22	11.09	2.32	11.87	2.39	12.66	2.51	13.44	2.55
18	10.30	2.21	11.09	2.31	11.87	2.45	12.66	2.51	13.44	2.54	10.30	2.24	11.09	2.34	11.87	2.47	12.66	2.54	13.44	2.57
20	10.30	2.24	11.09	2.34	11.87	2.47	12.66	2.53	13.44	2.56	10.30	2.26	11.09	2.36	11.87	2.50	12.66	2.56	13.44	2.59
22	10.30	2.26	11.09	2.37	11.87	2.50	12.66	2.56	13.44	2.60	10.30	2.29	11.09	2.39	11.87	2.52	12.66	2.59	13.44	2.62
24	10.30	2.29	11.09	2.40	11.87	2.53	12.66	2.60	13.44	2.63	10.30	2.32	11.09	2.42	11.87	2.56	12.66	2.62	13.44	2.66
25	10.30	2.31	11.09	2.42	11.87	2.56	12.66	2.62	13.44	2.65	10.30	2.33	11.09	2.44	11.87	2.58	12.66	2.64	13.44	2.68
26	10.24	2.32	11.02	2.43	11.80	2.57	12.59	2.63	13.40	2.66	10.24	2.34	11.02	2.45	11.80	2.59	12.59	2.65	13.40	2.69
28	10.10	2.35	10.89	2.45	11.67	2.59	12.45	2.65	13.31	2.69	10.10	2.37	10.89	2.47	11.67	2.61	12.45	2.68	13.31	2.71
30	9.97	2.37	10.75	2.47	11.54	2.61	12.32	2.67	13.22	2.71	9.97	2.39	10.75	2.50	11.54	2.64	12.32	2.70	13.22	2.73
32	9.83	2.43	10.62	2.54	11.40	2.68	12.19	2.74	13.04	2.77	9.83	2.46	10.62	2.56	11.40	2.70	12.19	2.77	13.04	2.80
34	9.70	2.50	10.48	2.61	11.27	2.74	12.05	2.81	12.86	2.84	9.70	2.52	10.48	2.63	11.27	2.77	12.05	2.83	12.86	2.87
35	9.63	2.53	10.42	2.64	11.20	2.78	11.98	2.84	12.77	2.87	9.63	2.56	10.42	2.66	11.20	2.81	11.98	2.87	12.77	2.90
36	9.54	2.60	10.33	2.71	11.11	2.85	11.89	2.91	12.66	2.95	9.54	2.63	10.33	2.74	11.11	2.88	11.89	2.94	12.66	2.98
38	9.36	2.75	10.15	2.86	10.93	2.99	11.72	3.06	12.43	3.10	9.36	2.77	10.15	2.88	10.93	3.02	11.72	3.09	12.43	3.13
40	9.18	2.89	9.97	3.00	10.75	3.14	11.54	3.21	12.21	3.25	9.18	2.92	9.97	3.03	10.75	3.17	11.54	3.24	12.21	3.29

To	Total power of combined indoor units (130%)									
	Ti									
	15/(21)		17/(24)		19/(27)		21/(29)		23/(31)	
	CAP	IPT	CAP	IPT	CAP	IPT	CAP	IPT	CAP	IPT
10	10.30	2.22	11.09	2.32	11.87	2.45	12.66	2.52	13.44	2.55
12	10.30	2.22	11.09	2.32	11.87	2.46	12.66	2.52	13.44	2.55
14	10.30	2.23	11.09	2.33	11.87	2.47	12.66	2.53	13.44	2.56
16	10.30	2.24	11.09	2.34	11.87	2.39	12.66	2.54	13.44	2.57
18	10.30	2.26	11.09	2.36	11.87	2.50	12.66	2.56	13.44	2.59
20	10.30	2.28	11.09	2.39	11.87	2.52	12.66	2.58	13.44	2.61
22	10.30	2.31	11.09	2.41	11.87	2.55	12.66	2.61	13.44	2.65
24	10.30	2.34	11.09	2.44	11.87	2.58	12.66	2.65	13.44	2.68
25	10.30	2.36	11.09	2.46	11.87	2.61	12.66	2.67	13.44	2.71
26	10.24	2.37	11.02	2.48	11.80	2.62	12.59	2.68	13.40	2.72
28	10.10	2.39	10.89	2.50	11.67	2.64	12.45	2.70	13.31	2.74
30	9.97	2.42	10.75	2.52	11.54	2.66	12.32	2.73	13.22	2.76
32	9.83	2.48	10.62	2.59	11.40	2.73	12.19	2.79	13.04	2.83
34	9.70	2.55	10.48	2.66	11.27	2.80	12.05	2.86	12.86	2.90
35	9.63	2.58	10.42	2.69	11.20	2.83	11.98	2.90	12.77	2.93
36	9.54	2.66	10.33	2.76	11.11	2.91	11.89	2.97	12.66	3.01
38	9.36	2.80	10.15	2.91	10.93	3.05	11.72	3.12	12.43	3.16
40	9.18	2.95	9.97	3.06	10.75	3.20	11.54	3.27	12.21	3.32

RAS-5FSVN2E

To	Total power of combined indoor units (50%)										Total power of combined indoor units (60%)									
	Ti										Ti									
	15/(21)		17/(24)		19/(27)		21/(29)		23/(31)		15/(21)		17/(24)		19/(27)		21/(29)		23/(31)	
	CAP	IPT	CAP	IPT	CAP	IPT	CAP	IPT	CAP	IPT	CAP	IPT	CAP	IPT	CAP	IPT	CAP	IPT	CAP	IPT
10	6.44	1.40	6.93	1.46	7.42	1.55	7.91	1.59	8.40	1.61	7.73	1.67	8.32	1.75	8.90	1.85	9.49	1.90	10.08	1.92
12	6.44	1.40	6.93	1.46	7.42	1.55	7.91	1.59	8.40	1.61	7.73	1.67	8.32	1.75	8.90	1.85	9.49	1.90	10.08	1.92
14	6.44	1.41	6.93	1.47	7.42	1.55	7.91	1.59	8.40	1.61	7.73	1.68	8.32	1.75	8.90	1.86	9.49	1.90	10.08	1.93
16	6.44	1.41	6.93	1.48	7.42	2.39	7.91	1.60	8.40	1.62	7.73	1.69	8.32	1.77	8.90	2.39	9.49	1.91	10.08	1.94
18	6.44	1.42	6.93	1.49	7.42	1.57	7.91	1.61	8.40	1.63	7.73	1.70	8.32	1.78	8.90	1.88	9.49	1.93	10.08	1.95
20	6.44	1.44	6.93	1.50	7.42	1.59	7.91	1.63	8.40	1.65	7.73	1.72	8.32	1.80	8.90	1.90	9.49	1.95	10.08	1.97
22	6.44	1.46	6.93	1.52	7.42	1.61	7.91	1.65	8.40	1.67	7.73	1.74	8.32	1.82	8.90	1.92	9.49	1.97	10.08	2.00
24	6.44	1.47	6.93	1.54	7.42	1.63	7.91	1.67	8.40	1.69	7.73	1.76	8.32	1.84	8.90	1.95	9.49	2.00	10.08	2.02
25	6.44	1.49	6.93	1.55	7.42	1.64	7.91	1.68	8.40	1.70	7.73	1.78	8.32	1.86	8.90	1.96	9.49	2.01	10.08	2.04
26	6.40	1.49	6.89	1.56	7.38	1.65	7.87	1.69	8.37	1.71	7.68	1.78	8.27	1.87	8.85	1.97	9.44	2.02	10.05	2.05
28	6.31	1.51	6.80	1.57	7.29	1.66	7.78	1.70	8.32	1.73	7.58	1.80	8.16	1.88	8.75	1.99	9.34	2.04	9.98	2.06
30	6.23	1.52	6.72	1.59	7.21	1.68	7.70	1.72	8.26	1.74	7.48	1.82	8.06	1.90	8.65	2.01	9.24	2.05	9.91	2.08
32	6.15	1.56	6.64	1.63	7.13	1.72	7.62	1.76	8.15	1.78	7.38	1.87	7.96	1.95	8.55	2.06	9.14	2.11	9.78	2.13
34	6.06	1.61	6.55	1.67	7.04	1.76	7.53	1.80	8.04	1.83	7.27	1.92	7.86	2.00	8.45	2.11	9.04	2.16	9.64	2.18
35	6.02	1.63	6.51	1.70	7.00	1.78	7.49	1.82	7.98	1.85	7.22	1.95	7.81	2.03	8.40	2.13	8.99	2.18	9.58	2.21
36	5.96	1.67	6.45	1.74	6.94	1.83	7.43	1.87	7.91	1.90	7.16	2.00	7.74	2.08	8.33	2.19	8.92	2.24	9.49	2.27
38	5.85	1.76	6.34	1.83	6.83	1.92	7.32	1.97	7.77	1.99	7.02	2.11	7.61	2.19	8.20	2.30	8.79	2.35	9.32	2.38
40	5.74	1.86	6.23	1.93	6.72	2.02	7.21	2.06	7.63	2.09	6.89	2.22	7.48	2.30	8.06	2.41	8.65	2.46	9.16	2.50

To	Total power of combined indoor units (70%)										Total power of combined indoor units (80%)									
	Ti										Ti									
	15/(21)		17/(24)		19/(27)		21/(29)		23/(31)		15/(21)		17/(24)		19/(27)		21/(29)		23/(31)	
	CAP	IPT	CAP	IPT	CAP	IPT	CAP	IPT	CAP	IPT	CAP	IPT	CAP	IPT	CAP	IPT	CAP	IPT	CAP	IPT
10	9.02	1.98	9.70	2.07	10.39	2.19	11.07	2.24	11.76	2.27	10.30	2.31	11.09	2.42	11.87	2.56	12.66	2.62	13.44	2.66
12	9.02	1.98	9.70	2.07	10.39	2.19	11.07	2.24	11.76	2.27	10.30	2.31	11.09	2.42	11.87	2.56	12.66	2.62	13.44	2.66
14	9.02	1.99	9.70	2.07	10.39	2.20	11.07	2.25	11.76	2.28	10.30	2.32	11.09	2.42	11.87	2.57	12.66	2.63	13.44	2.66
16	9.02	2.00	9.70	2.09	10.39	2.39	11.07	2.26	11.76	2.29	10.30	2.34	11.09	2.44	11.87	2.39	12.66	2.64	13.44	2.68
18	9.02	2.01	9.70	2.10	10.39	2.22	11.07	2.28	11.76	2.31	10.30	2.35	11.09	2.46	11.87	2.60	12.66	2.67	13.44	2.70
20	9.02	2.03	9.70	2.12	10.39	2.25	11.07	2.30	11.76	2.33	10.30	2.37	11.09	2.48	11.87	2.63	12.66	2.69	13.44	2.72
22	9.02	2.06	9.70	2.15	10.39	2.27	11.07	2.33	11.76	2.36	10.30	2.40	11.09	2.51	11.87	2.65	12.66	2.72	13.44	2.76
24	9.02	2.08	9.70	2.18	10.39	2.30	11.07	2.36	11.76	2.39	10.30	2.43	11.09	2.55	11.87	2.69	12.66	2.76	13.44	2.79
25	9.02	2.10	9.70	2.19	10.39	2.32	11.07	2.38	11.76	2.41	10.30	2.45	11.09	2.57	11.87	2.71	12.66	2.78	13.44	2.82
26	8.96	2.11	9.64	2.20	10.33	2.33	11.02	2.39	11.72	2.42	10.24	2.46	11.02	2.58	11.80	2.72	12.59	2.79	13.40	2.83
28	8.84	2.13	9.53	2.22	10.21	2.35	10.90	2.41	11.64	2.44	10.10	2.49	10.89	2.60	11.67	2.75	12.45	2.81	13.31	2.85
30	8.72	2.15	9.41	2.24	10.09	2.37	10.78	2.43	11.56	2.46	9.97	2.52	10.75	2.62	11.54	2.77	12.32	2.84	13.22	2.88
32	8.60	2.21	9.29	2.31	9.98	2.43	10.66	2.49	11.41	2.52	9.83	2.58	10.62	2.70	11.40	2.84	12.19	2.91	13.04	2.95
34	8.49	2.27	9.17	2.37	9.86	2.49	10.54	2.55	11.25	2.58	9.70	2.65	10.48	2.77	11.27	2.91	12.05	2.98	12.86	3.02
35	8.43	2.30	9.11	2.40	9.80	2.52	10.49	2.58	11.17	2.61	9.63	2.69	10.42	2.80	11.20	2.95	11.98	3.02	12.77	3.05
36	8.35	2.36	9.04	2.46	9.72	2.59	10.41	2.65	11.07	2.68	9.54	2.77	10.33	2.88	11.11	3.03	11.89	3.09	12.66	3.13
38	8.19	2.49	8.88	2.59	9.56	2.72	10.25	2.78	10.88	2.82	9.36	2.91	10.15	3.03	10.93	3.18	11.72	3.25	12.43	3.29
40	8.04	2.62	8.72	2.72	9.41	2.85	10.09	2.91	10.68	2.95	9.18	3.07	9.97	3.18	10.75	3.33	11.54	3.41	12.21	3.46

To	Total power of combined indoor units (90%)										Total power of combined indoor units (100%)									
	Ti										Ti									
	15/(21)		17/(24)		19/(27)		21/(29)		23/(31)		15/(21)		17/(24)		19/(27)		21/(29)		23/(31)	
	CAP	IPT	CAP	IPT	CAP	IPT	CAP	IPT	CAP	IPT	CAP	IPT	CAP	IPT	CAP	IPT	CAP	IPT	CAP	IPT
10	11.59	2.65	12.47	2.77	13.36	2.93	14.24	3.00	15.12	3.04	12.88	3.04	13.86	3.18	14.84	3.36	15.82	3.45	16.80	3.49
12	11.59	2.65	12.47	2.77	13.36	2.93	14.24	3.00	15.12	3.04	12.88	3.04	13.86	3.18	14.84	3.37	15.82	3.45	16.80	3.49
14	11.59	2.66	12.47	2.78	13.36	2.94	14.24	3.01	15.12	3.05	12.88	3.06	13.86	3.19	14.84	3.38	15.82	3.46	16.80	3.50
16	11.59	2.67	12.47	2.79	13.36	2.93	14.24	3.03	15.12	3.06	12.88	3.07	13.86	3.21	14.84	3.39	15.82	3.48	16.80	3.52
18	11.59	2.69	12.47	2.81	13.36	2.98	14.24	3.05	15.12	3.09	12.88	3.09	13.86	3.23	14.84	3.42	15.82	3.51	16.80	3.55
20	11.59	2.72	12.47	2.84	13.36	3.01	14.24	3.08	15.12	3.12	12.88	3.12	13.86	3.27	14.84	3.46	15.82	3.54	16.80	3.58
22	11.59	2.75	12.47	2.87	13.36	3.04	14.24	3.11	15.12	3.16	12.88	3.16	13.86	3.30	14.84	3.49	15.82	3.58	16.80	3.63
24	11.59	2.79	12.47	2.91	13.36	3.08	14.24	3.16	15.12	3.20	12.88	3.20	13.86	3.35	14.84	3.54	15.82	3.63	16.80	3.67
25	11.59	2.81	12.47	2.94	13.36	3.11	14.24	3.18	15.12	3.22	12.88	3.23	13.86	3.38	14.84	3.57	15.82	3.66	16.80	3.71
26	11.52	2.82	12.40	2.95	13.28	3.12	14.16	3.20	15.07	3.24	12.80	3.24	13.78	3.39	14.76	3.59	15.74	3.67	16.74	3.72
28	11.37	2.85	12.25	2.98	13.13	3.15	14.01	3.22	14.97	3.26	12.63	3.28	13.61	3.42	14.59	3.62	15.57	3.70	16.63	3.75
30	11.21	2.88	12.10	3.00	12.98	3.17	13.86	3.25	14.87	3.29	12.46	3.31	13.44	3.45	14.42	3.65	15.40	3.73	16.52	3.78
32	11.06	2.96	11.94	3.09	12.83	3.25	13.71	3.33	14.67	3.37	12.29	3.40	13.27	3.55	14.25	3.74	15.23	3.83	16.30	3.88
34	10.91	3.04	11.79	3.17	12.68	3.34	13.56	3.41	14.46	3.45	12.12	3.49	13.10	3.64	14.08	3.83	15.06	3.92	16.07	3.97
35	10.84	3.08	11.72	3.21	12.60	3.38	13.48	3.45	14.36	3.49	12.04	3.54	13.02	3.69	14.00	3.88	14.98	3.97	15.96	4.02
36	10.74	3.17	11.62	3.29	12.50	3.46	13.38	3.54	14.24	3.59	11.93	3.64	12.91	3.79	13.89	3.98	14.87	4.07	15.82	4.12
38	10.53	3.34	11.42	3.47	12.30	3.64	13.18	3.72	13.99	3.77	11.70	3.84	12.68	3.99	13.66	4.18	14.64	4.28	15.54	4.33
40	10.33	3.51	11.21	3.65	12.10	3.81	12.98	3.90	13.73	3.96	11.48	4.04	12.46	4.19	13.44	4.38	14.42	4.48	15.26	4.55

To	Total power of combined indoor units (110%)										Total power of combined indoor units (120%)									
	Ti										Ti									
	15/(21)		17/(24)		19/(27)		21/(29)		23/(31)		15/(21)		17/(24)		19/(27)		21/(29)		23/(31)	
	CAP	IPT	CAP	IPT	CAP	IPT	CAP	IPT	CAP	IPT	CAP	IPT	CAP	IPT	CAP	IPT	CAP	IPT	CAP	IPT
10	12.88	3.08	13.86	3.21	14.84	3.40	15.82	3.48	16.80	3.53	12.88	3.26	13.86	3.41	14.84	3.60	15.82	3.69	16.80	3.74
12	12.88	3.08	13.86	3.21	14.84	3.40	15.82	3.49	16.80	3.53	12.88	3.26	13.86	3.41	14.84	3.61	15.82	3.69	16.80	3.74
14	12.88	3.09	13.86	3.22	14.84	3.41	15.82	3.49	16.80	3.54	12.88	3.27	13.86	3.42	14.84	3.62	15.82	3.70	16.80	3.75
16	12.88	3.10	13.86	3.24	14.84	2.39	15.82	3.51	16.80	3.56	12.88	3.29	13.86	3.44	14.84	2.39	15.82	3.72	16.80	3.77
18	12.88	3.12	13.86	3.26	14.84	3.46	15.82	3.54	16.80	3.59	12.88	3.31	13.86	3.46	14.84	3.66	15.82	3.76	16.80	3.81
20	12.88	3.16	13.86	3.30	14.84	3.49	15.82	3.57	16.80	3.62	12.88	3.35	13.86	3.50	14.84	3.70	15.82	3.79	16.80	3.83
22	12.88	3.20	13.86	3.34	14.84	3.52	15.82	3.62	16.80	3.66	12.88	3.39	13.86	3.54	14.84	3.74	15.82	3.83	16.80	3.88
24	12.88	3.24	13.86	3.38	14.84	3.58	15.82	3.66	16.80	3.71	12.88	3.43	13.86	3.59	14.84	3.79	15.82	3.88	16.80	3.93
25	12.88	3.26	13.86	3.41	14.84	3.61	15.82	3.69	16.80	3.74	12.88	3.46	13.86	3.61	14.84	3.82	15.82	3.92	16.80	3.97
26	12.80	3.28	13.78	3.43	14.76	3.62	15.74	3.71	16.74	3.76	12.80	3.47	13.78	3.63	14.76	3.84	15.74	3.93	16.74	3.98
28	12.63	3.31	13.61	3.46	14.59	3.65	15.57	3.74	16.63	3.79	12.63	3.51	13.61	3.66	14.59	3.87	15.57	3.97	16.63	4.02
30	12.46	3.34	13.44	3.49	14.42	3.68	15.40	3.77	16.52	3.82	12.46	3.54	13.44	3.70	14.42	3.90	15.40	4.00	16.52	4.05
32	12.29	3.43	13.27	3.58	14.25	3.78	15.23	3.87	16.30	3.91	12.29	3.64	13.27	3.80	14.25	4.00	15.23	4.10	16.30	4.15
34	12.12	3.53	13.10	3.68	14.08	3.87	15.06	3.96	16.07	4.01	12.12	3.74	13.10	3.90	14.08	4.10	15.06	4.20	16.07	4.25
35	12.04	3.57	13.02	3.72	14.00	3.92	14.98	4.01	15.96	4.06	12.04	3.79	13.02	3.95	14.00	4.15	14.98	4.25	15.96	4.30
36	11.93	3.67	12.91	3.82	13.89	4.02	14.87	4.11	15.82	4.16	11.93	3.90	12.91	4.05	13.89	4.26	14.87	4.36	15.82	4.41
38	11.70	3.87	12.68	4.03	13.66	4.22	14.64	4.32	15.54	4.38	11.70	4.11	12.68	4.27	13.66	4.48	14.64	4.58	15.54	4.64
40	11.48	4.08	12.46	4.23	13.44	4.43	14.42	4.53	15.26	4.59	11.48	4.32	12.46	4.49	13.44	4.69	14.42	4.80	15.26	4.87

To	Total power of combined indoor units (130%)									
	Ti									
	15/(21)		17/(24)		19/(27)		21/(29)		23/(31)	
	CAP	IPT	CAP	IPT	CAP	IPT	CAP	IPT	CAP	IPT
10	12.88	3.14	13.86	3.28	14.84	3.46	15.82	3.55	16.80	3.60
12	12.88	3.14	13.86	3.28	14.84	3.47	15.82	3.55	16.80	3.60
14	12.88	3.15	13.86	3.29	14.84	3.48	15.82	3.56	16.80	3.61
16	12.88	3.16	13.86	3.31	14.84	2.39	15.82	3.58	16.80	3.63
18	12.88	3.19	13.86	3.33	14.84	3.52	15.82	3.61	16.80	3.66
20	12.88	3.22	13.86	3.37	14.84	3.56	15.82	3.65	16.80	3.69
22	12.88	3.26	13.86	3.40	14.84	3.59	15.82	3.69	16.80	3.74
24	12.88	3.30	13.86	3.45	14.84	3.65	15.82	3.74	16.80	3.78
25	12.88	3.33	13.86	3.48	14.84	3.68	15.82	3.77	16.80	3.82
26	12.80	3.34	13.78	3.49	14.76	3.69	15.74	3.78	16.74	3.83
28	12.63	3.38	13.61	3.52	14.59	3.72	15.57	3.81	16.63	3.86
30	12.46	3.41	13.44	3.56	14.42	3.76	15.40	3.85	16.52	3.90
32	12.29	3.50	13.27	3.65	14.25	3.85	15.23	3.94	16.30	3.99
34	12.12	3.60	13.10	3.75	14.08	3.95	15.06	4.04	16.07	4.09
35	12.04	3.64	13.02	3.80	14.00	4.00	14.98	4.09	15.96	4.14
36	11.93	3.75	12.91	3.90	13.89	4.10	14.87	4.19	15.82	4.25
38	11.70	3.95	12.68	4.11	13.66	4.31	14.64	4.40	15.54	4.46
40	11.48	4.16	12.46	4.32	13.44	4.52	14.42	4.62	15.26	4.68

4

RAS-6FSVN2E

To	Total power of combined indoor units (50%)										Total power of combined indoor units (60%)									
	Ti										Ti									
	15/(21)		17/(24)		19/(27)		21/(29)		23/(31)		15/(21)		17/(24)		19/(27)		21/(29)		23/(31)	
	CAP	IPT	CAP	IPT	CAP	IPT	CAP	IPT	CAP	IPT	CAP	IPT	CAP	IPT	CAP	IPT	CAP	IPT	CAP	IPT
10	6.90	1.69	7.52	1.76	8.06	1.86	8.60	1.91	9.22	1.93	8.28	2.02	9.02	2.11	9.67	2.23	10.32	2.28	11.07	2.31
12	6.90	1.69	7.52	1.76	8.06	1.87	8.60	1.91	9.22	1.93	8.28	2.02	9.02	2.11	9.67	2.23	10.32	2.28	11.07	2.31
14	6.90	1.69	7.52	1.77	8.06	1.87	8.60	1.92	9.22	1.94	8.28	2.02	9.02	2.11	9.67	2.24	10.32	2.29	11.07	2.32
16	6.90	1.70	7.52	1.78	8.06	2.39	8.60	1.93	9.22	1.95	8.28	2.03	9.02	2.13	9.67	2.39	10.32	2.30	11.07	2.33
18	6.90	1.71	7.52	1.79	8.06	1.89	8.60	1.94	9.22	1.97	8.28	2.05	9.02	2.14	9.67	2.26	10.32	2.32	11.07	2.35
20	6.90	1.73	7.52	1.81	8.06	1.91	8.60	1.96	9.22	1.98	8.28	2.07	9.02	2.16	9.67	2.29	10.32	2.34	11.07	2.37
22	6.90	1.75	7.52	1.83	8.06	1.93	8.60	1.98	9.22	2.01	8.28	2.09	9.02	2.19	9.67	2.31	10.32	2.37	11.07	2.40
24	6.90	1.77	7.52	1.85	8.06	1.96	8.60	2.01	9.22	2.03	8.28	2.12	9.02	2.22	9.67	2.34	10.32	2.40	11.07	2.43
25	6.90	1.79	7.52	1.87	8.06	1.98	8.60	2.02	9.22	2.05	8.28	2.14	9.02	2.23	9.67	2.36	10.32	2.42	11.07	2.45
26	6.88	1.80	7.50	1.88	8.04	1.98	8.59	2.03	9.21	2.06	8.26	2.15	9.00	2.24	9.65	2.37	10.30	2.43	11.05	2.46
28	6.85	1.82	7.47	1.89	8.01	2.00	8.56	2.05	9.18	2.08	8.22	2.17	8.97	2.27	9.62	2.39	10.27	2.45	11.01	2.48
30	6.82	1.83	7.44	1.91	7.98	2.02	8.53	2.07	9.15	2.09	8.18	2.19	8.93	2.29	9.58	2.41	10.23	2.47	10.97	2.50
32	6.73	1.88	7.35	1.96	7.89	2.07	8.43	2.12	9.05	2.15	8.07	2.25	8.82	2.35	9.47	2.48	10.12	2.53	10.86	2.57
34	6.63	1.93	7.25	2.02	7.80	2.12	8.34	2.17	8.96	2.20	7.96	2.31	8.70	2.41	9.36	2.54	10.01	2.60	10.75	2.63
35	6.59	1.96	7.21	2.04	7.75	2.15	8.29	2.20	8.91	2.22	7.90	2.34	8.65	2.44	9.30	2.57	9.95	2.63	10.70	2.66
36	6.54	2.01	7.15	2.10	7.69	2.20	8.20	2.25	8.76	2.28	7.85	2.41	8.57	2.51	9.23	2.64	9.84	2.69	10.51	2.73
38	6.45	2.12	7.02	2.21	7.56	2.32	8.01	2.37	8.45	2.40	7.74	2.54	8.43	2.64	9.08	2.77	9.62	2.83	10.14	2.87
40	6.36	2.23	6.90	2.32	7.44	2.43	7.83	2.48	8.14	2.52	7.63	2.67	8.28	2.77	8.93	2.90	9.39	2.97	9.77	3.01

To	Total power of combined indoor units (70%)										Total power of combined indoor units (80%)									
	Ti										Ti									
	15/(21)		17/(24)		19/(27)		21/(29)		23/(31)		15/(21)		17/(24)		19/(27)		21/(29)		23/(31)	
	CAP	IPT	CAP	IPT	CAP	IPT	CAP	IPT	CAP	IPT	CAP	IPT	CAP	IPT	CAP	IPT	CAP	IPT	CAP	IPT
10	9.66	2.38	10.52	2.49	11.28	2.63	12.04	2.70	12.91	2.73	11.04	2.79	12.03	2.91	12.90	3.08	13.76	3.15	14.76	3.20
12	9.66	2.38	10.52	2.49	11.28	2.64	12.04	2.70	12.91	2.73	11.04	2.79	12.03	2.91	12.90	3.08	13.76	3.16	14.76	3.20
14	9.66	2.39	10.52	2.50	11.28	2.64	12.04	2.71	12.91	2.74	11.04	2.80	12.03	2.92	12.90	3.09	13.76	3.16	14.76	3.20
16	9.66	2.40	10.52	2.51	11.28	2.39	12.04	2.72	12.91	2.76	11.04	2.81	12.03	2.94	12.90	3.09	13.76	3.18	14.76	3.22
18	9.66	2.42	10.52	2.53	11.28	2.68	12.04	2.74	12.91	2.78	11.04	2.83	12.03	2.96	12.90	3.13	13.76	3.21	14.76	3.25
20	9.66	2.44	10.52	2.56	11.28	2.70	12.04	2.77	12.91	2.80	11.04	2.86	12.03	2.99	12.90	3.16	13.76	3.24	14.76	3.28
22	9.66	2.48	10.52	2.59	11.28	2.73	12.04	2.80	12.91	2.84	11.04	2.89	12.03	3.02	12.90	3.19	13.76	3.27	14.76	3.32
24	9.66	2.51	10.52	2.62	11.28	2.77	12.04	2.84	12.91	2.87	11.04	2.93	12.03	3.06	12.90	3.24	13.76	3.32	14.76	3.36
25	9.66	2.53	10.52	2.64	11.28	2.79	12.04	2.86	12.91	2.90	11.04	2.95	12.03	3.09	12.90	3.27	13.76	3.35	14.76	3.39
26	9.63	2.54	10.50	2.65	11.26	2.80	12.02	2.87	12.89	2.91	11.01	2.97	12.00	3.10	12.87	3.28	13.74	3.36	14.73	3.40
28	9.59	2.56	10.46	2.68	11.22	2.83	11.98	2.90	12.85	2.94	10.96	3.00	11.95	3.13	12.82	3.31	13.69	3.39	14.68	3.43
30	9.55	2.59	10.42	2.70	11.18	2.85	11.94	2.92	12.80	2.96	10.91	3.03	11.90	3.16	12.77	3.34	13.64	3.42	14.63	3.46
32	9.42	2.66	10.29	2.77	11.05	2.93	11.80	2.99	12.67	3.03	10.76	3.11	11.76	3.24	12.62	3.42	13.49	3.50	14.48	3.55
34	9.29	2.73	10.16	2.85	10.92	3.00	11.67	3.07	12.54	3.11	10.61	3.19	11.61	3.33	12.47	3.51	13.34	3.59	14.33	3.63
35	9.22	2.77	10.09	2.88	10.85	3.04	11.61	3.10	12.48	3.14	10.54	3.24	11.53	3.37	12.40	3.55	13.27	3.63	14.26	3.67
36	9.16	2.85	10.00	2.96	10.76	3.11	11.48	3.18	12.26	3.22	10.47	3.33	11.43	3.46	12.30	3.64	13.12	3.72	14.01	3.77
38	9.03	3.00	9.83	3.12	10.59	3.27	11.22	3.35	11.83	3.39	10.32	3.51	11.23	3.65	12.10	3.83	12.82	3.91	13.52	3.96
40	8.90	3.16	9.66	3.28	10.42	3.43	10.96	3.51	11.39	3.56	10.17	3.69	11.04	3.83	11.90	4.01	12.52	4.10	13.02	4.16

To	Total power of combined indoor units (90%)										Total power of combined indoor units (100%)									
	Ti										Ti									
	15/(21)		17/(24)		19/(27)		21/(29)		23/(31)		15/(21)		17/(24)		19/(27)		21/(29)		23/(31)	
	CAP	IPT	CAP	IPT	CAP	IPT	CAP	IPT	CAP	IPT	CAP	IPT	CAP	IPT	CAP	IPT	CAP	IPT	CAP	IPT
10	12.42	3.19	13.53	3.33	14.51	3.52	15.48	3.61	16.60	3.66	13.80	3.66	15.04	3.83	16.12	4.05	17.21	4.15	18.45	4.21
12	12.42	3.19	13.53	3.33	14.51	3.53	15.48	3.61	16.60	3.66	13.80	3.66	15.04	3.83	16.12	4.06	17.21	4.15	18.45	4.21
14	12.42	3.20	13.53	3.34	14.51	3.54	15.48	3.62	16.60	3.67	13.80	3.68	15.04	3.84	16.12	4.07	17.21	4.16	18.45	4.22
16	12.42	3.22	13.53	3.36	14.51	2.39	15.48	3.64	16.60	3.69	13.80	3.70	15.04	3.86	16.12	2.39	17.21	4.19	18.45	4.24
18	12.42	3.24	13.53	3.38	14.51	3.58	15.48	3.67	16.60	3.72	13.80	3.72	15.04	3.89	16.12	4.12	17.21	4.22	18.45	4.28
20	12.42	3.27	13.53	3.42	14.51	3.62	15.48	3.71	16.60	3.75	13.80	3.76	15.04	3.93	16.12	4.16	17.21	4.26	18.45	4.31
22	12.42	3.31	13.53	3.46	14.51	3.65	15.48	3.75	16.60	3.80	13.80	3.81	15.04	3.98	16.12	4.20	17.21	4.31	18.45	4.37
24	12.42	3.35	13.53	3.51	14.51	3.71	15.48	3.80	16.60	3.85	13.80	3.86	15.04	4.03	16.12	4.26	17.21	4.37	18.45	4.42
25	12.42	3.38	13.53	3.53	14.51	3.74	15.48	3.83	16.60	3.88	13.80	3.89	15.04	4.06	16.12	4.30	17.21	4.40	18.45	4.46
26	12.39	3.40	13.50	3.55	14.48	3.75	15.46	3.85	16.57	3.90	13.76	3.90	15.00	4.08	16.09	4.32	17.17	4.42	18.41	4.48
28	12.33	3.43	13.45	3.58	14.42	3.79	15.40	3.88	16.52	3.93	13.70	3.95	14.94	4.12	16.03	4.35	17.11	4.46	18.35	4.52
30	12.28	3.47	13.39	3.62	14.37	3.82	15.35	3.91	16.46	3.96	13.64	3.98	14.88	4.16	15.97	4.39	17.05	4.49	18.29	4.55
32	12.11	3.56	13.22	3.71	14.20	3.92	15.18	4.01	16.29	4.06	13.45	4.09	14.69	4.27	15.78	4.50	16.86	4.61	18.10	4.67
34	11.94	3.66	13.06	3.81	14.03	4.01	15.01	4.11	16.13	4.16	13.27	4.20	14.51	4.38	15.59	4.61	16.68	4.72	17.92	4.78
35	11.86	3.70	12.97	3.86	13.95	4.06	14.93	4.15	16.04	4.21	13.18	4.26	14.42	4.44	15.50	4.67	16.59	4.78	17.83	4.83
36	11.77	3.81	12.86	3.97	13.84	4.17	14.76	4.26	15.76	4.32	13.08	4.38	14.29	4.56	15.38	4.79	16.40	4.90	17.52	4.96
38	11.61	4.02	12.64	4.18	13.62	4.38	14.42	4.48	15.21	4.54	12.90	4.62	14.04	4.80	15.13	5.03	16.03	5.15	16.90	5.22
40	11.44	4.23	12.42	4.39	13.39	4.59	14.09	4.69	14.65	4.76	12.71	4.86	13.80	5.04	14.88	5.28	15.66	5.39	16.28	5.47

To	Total power of combined indoor units (110%)										Total power of combined indoor units (120%)									
	Ti										Ti									
	15/(21)		17/(24)		19/(27)		21/(29)		23/(31)		15/(21)		17/(24)		19/(27)		21/(29)		23/(31)	
	CAP	IPT	CAP	IPT	CAP	IPT	CAP	IPT	CAP	IPT	CAP	IPT	CAP	IPT	CAP	IPT	CAP	IPT	CAP	IPT
10	13.80	3.70	15.04	3.87	16.12	4.09	17.21	4.19	18.45	4.25	13.80	3.74	15.04	3.91	16.12	4.13	17.21	4.23	18.45	4.29
12	13.80	3.70	15.04	3.87	16.12	4.10	17.21	4.19	18.45	4.25	13.80	3.74	15.04	3.91	16.12	4.14	17.21	4.24	18.45	4.29
14	13.80	3.72	15.04	3.88	16.12	4.11	17.21	4.21	18.45	4.26	13.80	3.75	15.04	3.92	16.12	4.15	17.21	4.25	18.45	4.30
16	13.80	3.74	15.04	3.90	16.12	2.39	17.21	4.23	18.45	4.28	13.80	3.77	15.04	3.94	16.12	2.39	17.21	4.27	18.45	4.32
18	13.80	3.76	15.04	3.93	16.12	4.16	17.21	4.27	18.45	4.32	13.80	3.80	15.04	3.97	16.12	4.20	17.21	4.31	18.45	4.36
20	13.80	3.80	15.04	3.97	16.12	4.20	17.21	4.30	18.45	4.35	13.80	3.84	15.04	4.01	16.12	4.24	17.21	4.35	18.45	4.40
22	13.80	3.85	15.04	4.02	16.12	4.24	17.21	4.35	18.45	4.41	13.80	3.88	15.04	4.06	16.12	4.28	17.21	4.39	18.45	4.45
24	13.80	3.89	15.04	4.07	16.12	4.30	17.21	4.41	18.45	4.47	13.80	3.93	15.04	4.11	16.12	4.35	17.21	4.45	18.45	4.51
25	13.80	3.93	15.04	4.10	16.12	4.34	17.21	4.45	18.45	4.50	13.80	3.96	15.04	4.14	16.12	4.38	17.21	4.49	18.45	4.55
26	13.76	3.94	15.00	4.12	16.09	4.36	17.17	4.46	18.41	4.52	13.76	3.98	15.00	4.16	16.09	4.40	17.17	4.51	18.41	4.57
28	13.70	3.99	14.94	4.16	16.03	4.40	17.11	4.50	18.35	4.56	13.70	4.02	14.94	4.20	16.03	4.44	17.11	4.55	18.35	4.61
30	13.64	4.02	14.88	4.20	15.97	4.43	17.05	4.54	18.29	4.60	13.64	4.06	14.88	4.24	15.97	4.48	17.05	4.58	18.29	4.64
32	13.45	4.13	14.69	4.31	15.78	4.55	16.86	4.65	18.10	4.71	13.45	4.17	14.69	4.35	15.78	4.59	16.86	4.70	18.10	4.76
34	13.27	4.24	14.51	4.42	15.59	4.66	16.68	4.77	17.92	4.83	13.27	4.29	14.51	4.47	15.59	4.71	16.68	4.81	17.92	4.87
35	13.18	4.30	14.42	4.48	15.50	4.72	16.59	4.82	17.83	4.88	13.18	4.34	14.42	4.53	15.50	4.76	16.59	4.87	17.83	4.93
36	13.08	4.42	14.29	4.60	15.38	4.84	16.40	4.95	17.52	5.01	13.08	4.47	14.29	4.65	15.38	4.89	16.40	5.00	17.52	5.06
38	12.90	4.66	14.04	4.85	15.13	5.08	16.03	5.20	16.90	5.27	12.90	4.71	14.04	4.90	15.13	5.13	16.03	5.25	16.90	5.32
40	12.71	4.91	13.80	5.09	14.88	5.33	15.66	5.45	16.28	5.53	12.71	4.95	13.80	5.14	14.88	5.38	15.66	5.50	16.28	5.58

4

To	Total power of combined indoor units (130%)									
	Ti									
	15/(21)		17/(24)		19/(27)		21/(29)		23/(31)	
	CAP	IPT	CAP	IPT	CAP	IPT	CAP	IPT	CAP	IPT
10	13.80	3.77	15.04	3.94	16.12	4.17	17.21	4.27	18.45	4.33
12	13.80	3.77	15.04	3.94	16.12	4.18	17.21	4.28	18.45	4.33
14	13.80	3.79	15.04	3.95	16.12	4.19	17.21	4.29	18.45	4.34
16	13.80	3.81	15.04	3.98	16.12	2.39	17.21	4.31	18.45	4.37
18	13.80	3.83	15.04	4.01	16.12	4.24	17.21	4.35	18.45	4.41
20	13.80	3.87	15.04	4.05	16.12	4.28	17.21	4.39	18.45	4.44
22	13.80	3.92	15.04	4.10	16.12	4.33	17.21	4.44	18.45	4.50
24	13.80	3.97	15.04	4.15	16.12	4.39	17.21	4.50	18.45	4.55
25	13.80	4.00	15.04	4.18	16.12	4.43	17.21	4.53	18.45	4.59
26	13.76	4.02	15.00	4.20	16.09	4.44	17.17	4.55	18.41	4.61
28	13.70	4.06	14.94	4.24	16.03	4.48	17.11	4.59	18.35	4.65
30	13.64	4.10	14.88	4.28	15.97	4.52	17.05	4.63	18.29	4.69
32	13.45	4.21	14.69	4.40	15.78	4.64	16.86	4.75	18.10	4.81
34	13.27	4.33	14.51	4.51	15.59	4.75	16.68	4.86	17.92	4.92
35	13.18	4.39	14.42	4.57	15.50	4.81	16.59	4.92	17.83	4.98
36	13.08	4.51	14.29	4.69	15.38	4.94	16.40	5.05	17.52	5.11
38	12.90	4.75	14.04	4.94	15.13	5.19	16.03	5.30	16.90	5.37
40	12.71	5.00	13.80	5.19	14.88	5.44	15.66	5.56	16.28	5.64

◆ RAS-(4-6)FSNY2E

RAS-4FSNY2E

To	Total power of combined indoor units (50%)										Total power of combined indoor units (60%)									
	Ti										Ti									
	15/(21)		17/(24)		19/(27)		21/(29)		23/(31)		15/(21)		17/(24)		19/(27)		21/(29)		23/(31)	
	CAP	IPT	CAP	IPT	CAP	IPT	CAP	IPT	CAP	IPT	CAP	IPT	CAP	IPT	CAP	IPT	CAP	IPT	CAP	IPT
10	5.15	0.98	5.54	1.03	5.94	1.08	6.33	1.11	6.72	1.13	6.18	1.17	6.65	1.23	7.12	1.30	7.59	1.33	8.06	1.35
12	5.15	0.98	5.54	1.03	5.94	1.09	6.33	1.11	6.72	1.13	6.18	1.17	6.65	1.23	7.12	1.30	7.59	1.33	8.06	1.35
14	5.15	0.99	5.54	1.03	5.94	1.09	6.33	1.12	6.72	1.13	6.18	1.18	6.65	1.23	7.12	1.30	7.59	1.33	8.06	1.35
16	5.15	0.99	5.54	1.04	5.94	2.39	6.33	1.12	6.72	1.14	6.18	1.18	6.65	1.24	7.12	2.39	7.59	1.34	8.06	1.36
18	5.15	1.00	5.54	1.04	5.94	1.10	6.33	1.13	6.72	1.15	6.18	1.19	6.65	1.25	7.12	1.32	7.59	1.35	8.06	1.37
20	5.15	1.01	5.54	1.05	5.94	1.11	6.33	1.14	6.72	1.15	6.18	1.20	6.65	1.26	7.12	1.33	7.59	1.36	8.06	1.38
22	5.15	1.02	5.54	1.07	5.94	1.13	6.33	1.15	6.72	1.17	6.18	1.22	6.65	1.27	7.12	1.35	7.59	1.38	8.06	1.40
24	5.15	1.03	5.54	1.08	5.94	1.14	6.33	1.17	6.72	1.18	6.18	1.24	6.65	1.29	7.12	1.36	7.59	1.40	8.06	1.42
25	5.15	1.04	5.54	1.09	5.94	1.15	6.33	1.18	6.72	1.19	6.18	1.25	6.65	1.30	7.12	1.38	7.59	1.41	8.06	1.43
26	5.12	1.05	5.51	1.09	5.90	1.16	6.29	1.18	6.70	1.20	6.14	1.25	6.61	1.31	7.08	1.38	7.55	1.42	8.04	1.43
28	5.05	1.06	5.44	1.10	5.84	1.17	6.23	1.19	6.65	1.21	6.06	1.26	6.53	1.32	7.00	1.39	7.47	1.43	7.98	1.45
30	4.98	1.07	5.38	1.11	5.77	1.18	6.16	1.20	6.61	1.22	5.98	1.28	6.45	1.33	6.92	1.41	7.39	1.44	7.93	1.46
32	4.92	1.10	5.31	1.14	5.70	1.21	6.09	1.23	6.52	1.25	5.90	1.31	6.37	1.37	6.84	1.44	7.31	1.48	7.82	1.49
34	4.85	1.13	5.24	1.17	5.63	1.24	6.03	1.26	6.43	1.28	5.82	1.35	6.29	1.40	6.76	1.48	7.23	1.51	7.71	1.53
35	4.82	1.14	5.21	1.19	5.60	1.25	5.99	1.28	6.38	1.29	5.78	1.36	6.25	1.42	6.72	1.50	7.19	1.53	7.66	1.55
36	4.77	1.17	5.16	1.22	5.56	1.28	5.95	1.31	6.33	1.33	5.73	1.40	6.20	1.46	6.67	1.53	7.14	1.57	7.59	1.59
38	4.68	1.24	5.07	1.29	5.47	1.35	5.86	1.38	6.22	1.40	5.62	1.48	6.09	1.54	6.56	1.61	7.03	1.65	7.46	1.67
40	4.59	1.30	4.98	1.35	5.38	1.41	5.77	1.45	6.10	1.47	5.51	1.56	5.98	1.62	6.45	1.69	6.92	1.73	7.32	1.75

To	Total power of combined indoor units (70%)										Total power of combined indoor units (80%)									
	Ti										Ti									
	15/(21)		17/(24)		19/(27)		21/(29)		23/(31)		15/(21)		17/(24)		19/(27)		21/(29)		23/(31)	
	CAP	IPT	CAP	IPT	CAP	IPT	CAP	IPT	CAP	IPT	CAP	IPT	CAP	IPT	CAP	IPT	CAP	IPT	CAP	IPT
10	7.21	1.39	7.76	1.45	8.31	1.53	8.86	1.57	9.41	1.59	8.24	1.62	8.87	1.70	9.50	1.79	10.12	1.84	10.75	1.86
12	7.21	1.39	7.76	1.45	8.31	1.54	8.86	1.57	9.41	1.59	8.24	1.62	8.87	1.70	9.50	1.80	10.12	1.84	10.75	1.86
14	7.21	1.39	7.76	1.45	8.31	1.54	8.86	1.58	9.41	1.60	8.24	1.63	8.87	1.70	9.50	1.80	10.12	1.84	10.75	1.87
16	7.21	1.40	7.76	1.46	8.31	2.39	8.86	1.58	9.41	1.60	8.24	1.64	8.87	1.71	9.50	2.39	10.12	1.85	10.75	1.88
18	7.21	1.41	7.76	1.47	8.31	1.56	8.86	1.60	9.41	1.62	8.24	1.65	8.87	1.72	9.50	1.82	10.12	1.87	10.75	1.89
20	7.21	1.42	7.76	1.49	8.31	1.57	8.86	1.61	9.41	1.63	8.24	1.66	8.87	1.74	9.50	1.84	10.12	1.89	10.75	1.91
22	7.21	1.44	7.76	1.51	8.31	1.59	8.86	1.63	9.41	1.65	8.24	1.69	8.87	1.76	9.50	1.86	10.12	1.91	10.75	1.93
24	7.21	1.46	7.76	1.53	8.31	1.61	8.86	1.65	9.41	1.67	8.24	1.71	8.87	1.78	9.50	1.89	10.12	1.93	10.75	1.96
25	7.21	1.47	7.76	1.54	8.31	1.63	8.86	1.67	9.41	1.69	8.24	1.72	8.87	1.80	9.50	1.90	10.12	1.95	10.75	1.97
26	7.17	1.48	7.71	1.55	8.26	1.63	8.81	1.67	9.38	1.70	8.19	1.73	8.82	1.81	9.44	1.91	10.07	1.96	10.72	1.98
28	7.07	1.49	7.62	1.56	8.17	1.65	8.72	1.69	9.31	1.71	8.08	1.75	8.71	1.82	9.34	1.93	9.96	1.97	10.64	2.00
30	6.98	1.51	7.53	1.57	8.08	1.66	8.62	1.70	9.25	1.72	7.97	1.76	8.60	1.84	9.23	1.94	9.86	1.99	10.57	2.02
32	6.88	1.55	7.43	1.62	7.98	1.70	8.53	1.74	9.13	1.77	7.87	1.81	8.49	1.89	9.12	1.99	9.75	2.04	10.43	2.07
34	6.79	1.59	7.34	1.66	7.89	1.75	8.44	1.79	9.00	1.81	7.76	1.86	8.39	1.94	9.01	2.04	9.64	2.09	10.29	2.11
35	6.74	1.61	7.29	1.68	7.84	1.77	8.39	1.81	8.94	1.83	7.71	1.89	8.33	1.96	8.96	2.07	9.59	2.11	10.21	2.14
36	6.68	1.66	7.23	1.73	7.78	1.81	8.33	1.85	8.86	1.88	7.63	1.94	8.26	2.02	8.89	2.12	9.52	2.17	10.12	2.20
38	6.55	1.75	7.10	1.82	7.65	1.91	8.20	1.95	8.70	1.97	7.49	2.04	8.12	2.13	8.74	2.23	9.37	2.28	9.95	2.31
40	6.43	1.84	6.98	1.91	7.53	2.00	8.08	2.04	8.55	2.07	7.35	2.15	7.97	2.23	8.60	2.34	9.23	2.39	9.77	2.42

To	Total power of combined indoor units (90%)										Total power of combined indoor units (100%)									
	Ti										Ti									
	15/(21)		17/(24)		19/(27)		21/(29)		23/(31)		15/(21)		17/(24)		19/(27)		21/(29)		23/(31)	
	CAP	IPT	CAP	IPT	CAP	IPT	CAP	IPT	CAP	IPT	CAP	IPT	CAP	IPT	CAP	IPT	CAP	IPT	CAP	IPT
10	9.27	1.86	9.98	1.94	10.68	2.05	11.39	2.10	12.10	2.13	10.30	2.13	11.09	2.23	11.87	2.36	12.66	2.42	13.44	2.45
12	9.27	1.86	9.98	1.94	10.68	2.06	11.39	2.10	12.10	2.13	10.30	2.13	11.09	2.23	11.87	2.36	12.66	2.42	13.44	2.45
14	9.27	1.86	9.98	1.95	10.68	2.06	11.39	2.11	12.10	2.14	10.30	2.14	11.09	2.24	11.87	2.37	12.66	2.43	13.44	2.46
16	9.27	1.87	9.98	1.96	10.68	2.39	11.39	2.12	12.10	2.15	10.30	2.15	11.09	2.25	11.87	2.39	12.66	2.44	13.44	2.47
18	9.27	1.89	9.98	1.97	10.68	2.09	11.39	2.14	12.10	2.17	10.30	2.17	11.09	2.26	11.87	2.40	12.66	2.46	13.44	2.49
20	9.27	1.91	9.98	1.99	10.68	2.11	11.39	2.16	12.10	2.18	10.30	2.19	11.09	2.29	11.87	2.42	12.66	2.48	13.44	2.51
22	9.27	1.93	9.98	2.02	10.68	2.13	11.39	2.18	12.10	2.21	10.30	2.22	11.09	2.32	11.87	2.45	12.66	2.51	13.44	2.54
24	9.27	1.95	9.98	2.04	10.68	2.16	11.39	2.21	12.10	2.24	10.30	2.25	11.09	2.35	11.87	2.48	12.66	2.54	13.44	2.58
25	9.27	1.97	9.98	2.06	10.68	2.18	11.39	2.23	12.10	2.26	10.30	2.26	11.09	2.37	11.87	2.50	12.66	2.56	13.44	2.60
26	9.21	1.98	9.92	2.07	10.62	2.19	11.33	2.24	12.06	2.27	10.24	2.27	11.02	2.38	11.80	2.51	12.59	2.57	13.40	2.61
28	9.09	2.00	9.80	2.09	10.50	2.21	11.21	2.26	11.98	2.29	10.10	2.30	10.89	2.40	11.67	2.54	12.45	2.60	13.31	2.63
30	8.97	2.02	9.68	2.11	10.38	2.22	11.09	2.28	11.89	2.31	9.97	2.32	10.75	2.42	11.54	2.56	12.32	2.62	13.22	2.65
32	8.85	2.07	9.56	2.16	10.26	2.28	10.97	2.33	11.73	2.36	9.83	2.38	10.62	2.49	11.40	2.62	12.19	2.68	13.04	2.72
34	8.73	2.13	9.43	2.22	10.14	2.34	10.85	2.39	11.57	2.42	9.70	2.45	10.48	2.55	11.27	2.69	12.05	2.75	12.86	2.78
35	8.67	2.16	9.37	2.25	10.08	2.37	10.79	2.42	11.49	2.45	9.63	2.48	10.42	2.58	11.20	2.72	11.98	2.78	12.77	2.82
36	8.59	2.22	9.29	2.31	10.00	2.43	10.70	2.48	11.39	2.51	9.54	2.55	10.33	2.65	11.11	2.79	11.89	2.85	12.66	2.89
38	8.43	2.34	9.13	2.43	9.84	2.55	10.54	2.61	11.19	2.64	9.36	2.69	10.15	2.80	10.93	2.93	11.72	3.00	12.43	3.04
40	8.27	2.46	8.97	2.56	9.68	2.67	10.38	2.73	10.99	2.77	9.18	2.83	9.97	2.94	10.75	3.07	11.54	3.14	12.21	3.19

4

To	Total power of combined indoor units (110%)										Total power of combined indoor units (120%)									
	Ti										Ti									
	15/(21)		17/(24)		19/(27)		21/(29)		23/(31)		15/(21)		17/(24)		19/(27)		21/(29)		23/(31)	
	CAP	IPT	CAP	IPT	CAP	IPT	CAP	IPT	CAP	IPT	CAP	IPT	CAP	IPT	CAP	IPT	CAP	IPT	CAP	IPT
10	10.30	2.16	11.09	2.25	11.87	2.38	12.66	2.44	13.44	2.47	10.30	2.18	11.09	2.28	11.87	2.40	12.66	2.46	13.44	2.50
12	10.30	2.16	11.09	2.25	11.87	2.39	12.66	2.44	13.44	2.47	10.30	2.18	11.09	2.28	11.87	2.41	12.66	2.47	13.44	2.50
14	10.30	2.16	11.09	2.26	11.87	2.39	12.66	2.45	13.44	2.48	10.30	2.19	11.09	2.28	11.87	2.42	12.66	2.47	13.44	2.51
16	10.30	2.18	11.09	2.27	11.87	2.39	12.66	2.46	13.44	2.49	10.30	2.20	11.09	2.30	11.87	2.39	12.66	2.49	13.44	2.52
18	10.30	2.19	11.09	2.29	11.87	2.42	12.66	2.48	13.44	2.52	10.30	2.21	11.09	2.31	11.87	2.45	12.66	2.51	13.44	2.54
20	10.30	2.21	11.09	2.31	11.87	2.45	12.66	2.51	13.44	2.54	10.30	2.23	11.09	2.34	11.87	2.47	12.66	2.53	13.44	2.56
22	10.30	2.24	11.09	2.34	11.87	2.47	12.66	2.53	13.44	2.57	10.30	2.26	11.09	2.36	11.87	2.49	12.66	2.56	13.44	2.59
24	10.30	2.27	11.09	2.37	11.87	2.51	12.66	2.57	13.44	2.60	10.30	2.29	11.09	2.39	11.87	2.53	12.66	2.59	13.44	2.63
25	10.30	2.29	11.09	2.39	11.87	2.53	12.66	2.59	13.44	2.62	10.30	2.31	11.09	2.41	11.87	2.55	12.66	2.61	13.44	2.65
26	10.24	2.30	11.02	2.40	11.80	2.54	12.59	2.60	13.40	2.63	10.24	2.32	11.02	2.42	11.80	2.56	12.59	2.63	13.40	2.66
28	10.10	2.32	10.89	2.42	11.67	2.56	12.45	2.62	13.31	2.66	10.10	2.34	10.89	2.45	11.67	2.59	12.45	2.65	13.31	2.68
30	9.97	2.34	10.75	2.45	11.54	2.58	12.32	2.64	13.22	2.68	9.97	2.37	10.75	2.47	11.54	2.61	12.32	2.67	13.22	2.71
32	9.83	2.41	10.62	2.51	11.40	2.65	12.19	2.71	13.04	2.74	9.83	2.43	10.62	2.54	11.40	2.67	12.19	2.74	13.04	2.77
34	9.70	2.47	10.48	2.58	11.27	2.71	12.05	2.78	12.86	2.81	9.70	2.50	10.48	2.60	11.27	2.74	12.05	2.80	12.86	2.84
35	9.63	2.51	10.42	2.61	11.20	2.75	11.98	2.81	12.77	2.84	9.63	2.53	10.42	2.64	11.20	2.77	11.98	2.84	12.77	2.87
36	9.54	2.58	10.33	2.68	11.11	2.82	11.89	2.88	12.66	2.92	9.54	2.60	10.33	2.71	11.11	2.85	11.89	2.91	12.66	2.95
38	9.36	2.72	10.15	2.82	10.93	2.96	11.72	3.03	12.43	3.07	9.36	2.74	10.15	2.85	10.93	2.99	11.72	3.06	12.43	3.10
40	9.18	2.86	9.97	2.97	10.75	3.10	11.54	3.17	12.21	3.22	9.18	2.89	9.97	3.00	10.75	3.14	11.54	3.20	12.21	3.25

To	Total power of combined indoor units (130%)									
	Ti									
	15/(21)		17/(24)		19/(27)		21/(29)		23/(31)	
	CAP	IPT	CAP	IPT	CAP	IPT	CAP	IPT	CAP	IPT
10	10.30	2.20	11.09	2.30	11.87	2.43	12.66	2.49	13.44	2.52
12	10.30	2.20	11.09	2.30	11.87	2.43	12.66	2.49	13.44	2.52
14	10.30	2.21	11.09	2.30	11.87	2.44	12.66	2.50	13.44	2.53
16	10.30	2.22	11.09	2.32	11.87	2.39	12.66	2.51	13.44	2.54
18	10.30	2.23	11.09	2.33	11.87	2.47	12.66	2.53	13.44	2.57
20	10.30	2.26	11.09	2.36	11.87	2.49	12.66	2.56	13.44	2.59
22	10.30	2.28	11.09	2.39	11.87	2.52	12.66	2.58	13.44	2.62
24	10.30	2.31	11.09	2.42	11.87	2.56	12.66	2.62	13.44	2.65
25	10.30	2.33	11.09	2.44	11.87	2.58	12.66	2.64	13.44	2.68
26	10.24	2.34	11.02	2.45	11.80	2.59	12.59	2.65	13.40	2.69
28	10.10	2.37	10.89	2.47	11.67	2.61	12.45	2.67	13.31	2.71
30	9.97	2.39	10.75	2.49	11.54	2.63	12.32	2.70	13.22	2.73
32	9.83	2.45	10.62	2.56	11.40	2.70	12.19	2.76	13.04	2.80
34	9.70	2.52	10.48	2.63	11.27	2.77	12.05	2.83	12.86	2.87
35	9.63	2.55	10.42	2.66	11.20	2.80	11.98	2.86	12.77	2.90
36	9.54	2.63	10.33	2.73	11.11	2.87	11.89	2.94	12.66	2.98
38	9.36	2.77	10.15	2.88	10.93	3.02	11.72	3.09	12.43	3.13
40	9.18	2.91	9.97	3.03	10.75	3.17	11.54	3.24	12.21	3.28

RAS-5FSNY2E

To	Total power of combined indoor units (50%)										Total power of combined indoor units (60%)									
	Ti										Ti									
	15/(21)		17/(24)		19/(27)		21/(29)		23/(31)		15/(21)		17/(24)		19/(27)		21/(29)		23/(31)	
	CAP	IPT	CAP	IPT	CAP	IPT	CAP	IPT	CAP	IPT	CAP	IPT	CAP	IPT	CAP	IPT	CAP	IPT	CAP	IPT
10	6.44	1.39	6.93	1.45	7.42	1.53	7.91	1.57	8.40	1.59	7.73	1.66	8.32	1.73	8.90	1.83	9.49	1.88	10.08	1.90
12	6.44	1.39	6.93	1.45	7.42	1.53	7.91	1.57	8.40	1.59	7.73	1.66	8.32	1.73	8.90	1.83	9.49	1.88	10.08	1.90
14	6.44	1.39	6.93	1.45	7.42	1.54	7.91	1.58	8.40	1.60	7.73	1.66	8.32	1.74	8.90	1.84	9.49	1.88	10.08	1.91
16	6.44	1.40	6.93	1.46	7.42	2.39	7.91	1.58	8.40	1.60	7.73	1.67	8.32	1.75	8.90	2.39	9.49	1.89	10.08	1.92
18	6.44	1.41	6.93	1.47	7.42	1.56	7.91	1.60	8.40	1.62	7.73	1.68	8.32	1.76	8.90	1.86	9.49	1.91	10.08	1.93
20	6.44	1.42	6.93	1.49	7.42	1.57	7.91	1.61	8.40	1.63	7.73	1.70	8.32	1.78	8.90	1.88	9.49	1.93	10.08	1.95
22	6.44	1.44	6.93	1.50	7.42	1.59	7.91	1.63	8.40	1.65	7.73	1.72	8.32	1.80	8.90	1.90	9.49	1.95	10.08	1.97
24	6.44	1.46	6.93	1.52	7.42	1.61	7.91	1.65	8.40	1.67	7.73	1.74	8.32	1.82	8.90	1.93	9.49	1.97	10.08	2.00
25	6.44	1.47	6.93	1.54	7.42	1.63	7.91	1.66	8.40	1.69	7.73	1.76	8.32	1.84	8.90	1.94	9.49	1.99	10.08	2.02
26	6.40	1.48	6.89	1.54	7.38	1.63	7.87	1.67	8.37	1.69	7.68	1.77	8.27	1.85	8.85	1.95	9.44	2.00	10.05	2.03
28	6.31	1.49	6.80	1.56	7.29	1.65	7.78	1.69	8.32	1.71	7.58	1.78	8.16	1.86	8.75	1.97	9.34	2.02	9.98	2.04
30	6.23	1.51	6.72	1.57	7.21	1.66	7.70	1.70	8.26	1.72	7.48	1.80	8.06	1.88	8.65	1.99	9.24	2.03	9.91	2.06
32	6.15	1.55	6.64	1.61	7.13	1.70	7.62	1.74	8.15	1.76	7.38	1.85	7.96	1.93	8.55	2.04	9.14	2.08	9.78	2.11
34	6.06	1.59	6.55	1.66	7.04	1.75	7.53	1.78	8.04	1.81	7.27	1.90	7.86	1.98	8.45	2.09	9.04	2.13	9.64	2.16
35	6.02	1.61	6.51	1.68	7.00	1.77	7.49	1.81	7.98	1.83	7.22	1.93	7.81	2.01	8.40	2.11	8.99	2.16	9.58	2.19
36	5.96	1.66	6.45	1.72	6.94	1.81	7.43	1.85	7.91	1.88	7.16	1.98	7.74	2.06	8.33	2.17	8.92	2.22	9.49	2.24
38	5.85	1.75	6.34	1.82	6.83	1.90	7.32	1.95	7.77	1.97	7.02	2.09	7.61	2.17	8.20	2.28	8.79	2.33	9.32	2.36
40	5.74	1.84	6.23	1.91	6.72	2.00	7.21	2.04	7.63	2.07	6.89	2.20	7.48	2.28	8.06	2.39	8.65	2.44	9.16	2.47

To	Total power of combined indoor units (70%)										Total power of combined indoor units (80%)									
	Ti										Ti									
	15/(21)		17/(24)		19/(27)		21/(29)		23/(31)		15/(21)		17/(24)		19/(27)		21/(29)		23/(31)	
	CAP	IPT	CAP	IPT	CAP	IPT	CAP	IPT	CAP	IPT	CAP	IPT	CAP	IPT	CAP	IPT	CAP	IPT	CAP	IPT
10	9.02	1.96	9.70	2.05	10.39	2.16	11.07	2.22	11.76	2.25	10.30	2.29	11.09	2.39	11.87	2.53	12.66	2.59	13.44	2.63
12	9.02	1.96	9.70	2.05	10.39	2.17	11.07	2.22	11.76	2.25	10.30	2.29	11.09	2.39	11.87	2.54	12.66	2.60	13.44	2.63
14	9.02	1.97	9.70	2.05	10.39	2.17	11.07	2.23	11.76	2.25	10.30	2.30	11.09	2.40	11.87	2.54	12.66	2.60	13.44	2.64
16	9.02	1.98	9.70	2.07	10.39	2.39	11.07	2.24	11.76	2.27	10.30	2.31	11.09	2.41	11.87	2.39	12.66	2.62	13.44	2.65
18	9.02	1.99	9.70	2.08	10.39	2.20	11.07	2.26	11.76	2.29	10.30	2.33	11.09	2.43	11.87	2.57	12.66	2.64	13.44	2.67
20	9.02	2.01	9.70	2.10	10.39	2.22	11.07	2.28	11.76	2.30	10.30	2.35	11.09	2.46	11.87	2.60	12.66	2.66	13.44	2.69
22	9.02	2.04	9.70	2.13	10.39	2.24	11.07	2.30	11.76	2.33	10.30	2.38	11.09	2.49	11.87	2.62	12.66	2.69	13.44	2.73
24	9.02	2.06	9.70	2.15	10.39	2.28	11.07	2.33	11.76	2.36	10.30	2.41	11.09	2.52	11.87	2.66	12.66	2.73	13.44	2.76
25	9.02	2.08	9.70	2.17	10.39	2.30	11.07	2.35	11.76	2.38	10.30	2.43	11.09	2.54	11.87	2.68	12.66	2.75	13.44	2.79
26	8.96	2.09	9.64	2.18	10.33	2.31	11.02	2.36	11.72	2.39	10.24	2.44	11.02	2.55	11.80	2.70	12.59	2.76	13.40	2.80
28	8.84	2.11	9.53	2.20	10.21	2.33	10.90	2.38	11.64	2.41	10.10	2.47	10.89	2.57	11.67	2.72	12.45	2.79	13.31	2.82
30	8.72	2.13	9.41	2.22	10.09	2.35	10.78	2.40	11.56	2.43	9.97	2.49	10.75	2.60	11.54	2.74	12.32	2.81	13.22	2.85
32	8.60	2.19	9.29	2.28	9.98	2.41	10.66	2.46	11.41	2.49	9.83	2.56	10.62	2.67	11.40	2.81	12.19	2.88	13.04	2.92
34	8.49	2.25	9.17	2.34	9.86	2.47	10.54	2.52	11.25	2.55	9.70	2.63	10.48	2.74	11.27	2.88	12.05	2.95	12.86	2.99
35	8.43	2.28	9.11	2.37	9.80	2.50	10.49	2.55	11.17	2.58	9.63	2.66	10.42	2.77	11.20	2.92	11.98	2.98	12.77	3.02
36	8.35	2.34	9.04	2.44	9.72	2.56	10.41	2.62	11.07	2.65	9.54	2.74	10.33	2.85	11.11	2.99	11.89	3.06	12.66	3.10
38	8.19	2.47	8.88	2.57	9.56	2.69	10.25	2.75	10.88	2.79	9.36	2.88	10.15	3.00	10.93	3.15	11.72	3.22	12.43	3.26
40	8.04	2.60	8.72	2.70	9.41	2.82	10.09	2.88	10.68	2.92	9.18	3.04	9.97	3.15	10.75	3.30	11.54	3.37	12.21	3.42

4

To	Total power of combined indoor units (90%)										Total power of combined indoor units (100%)									
	Ti										Ti									
	15/(21)		17/(24)		19/(27)		21/(29)		23/(31)		15/(21)		17/(24)		19/(27)		21/(29)		23/(31)	
	CAP	IPT	CAP	IPT	CAP	IPT	CAP	IPT	CAP	IPT	CAP	IPT	CAP	IPT	CAP	IPT	CAP	IPT	CAP	IPT
10	11.59	2.62	12.47	2.74	13.36	2.89	14.24	2.97	15.12	3.01	12.88	3.01	13.86	3.15	14.84	3.33	15.82	3.41	16.80	3.46
12	11.59	2.62	12.47	2.74	13.36	2.90	14.24	2.97	15.12	3.01	12.88	3.01	13.86	3.15	14.84	3.34	15.82	3.42	16.80	3.46
14	11.59	2.63	12.47	2.75	13.36	2.91	14.24	2.98	15.12	3.02	12.88	3.03	13.86	3.16	14.84	3.34	15.82	3.42	16.80	3.47
16	11.59	2.65	12.47	2.76	13.36	2.39	14.24	2.99	15.12	3.03	12.88	3.04	13.86	3.18	14.84	2.39	15.82	3.44	16.80	3.49
18	11.59	2.66	12.47	2.78	13.36	2.95	14.24	3.02	15.12	3.06	12.88	3.06	13.86	3.20	14.84	3.39	15.82	3.47	16.80	3.52
20	11.59	2.69	12.47	2.81	13.36	2.98	14.24	3.05	15.12	3.08	12.88	3.09	13.86	3.23	14.84	3.42	15.82	3.50	16.80	3.54
22	11.59	2.72	12.47	2.85	13.36	3.00	14.24	3.08	15.12	3.12	12.88	3.13	13.86	3.27	14.84	3.45	15.82	3.54	16.80	3.59
24	11.59	2.76	12.47	2.88	13.36	3.05	14.24	3.12	15.12	3.16	12.88	3.17	13.86	3.31	14.84	3.50	15.82	3.59	16.80	3.64
25	11.59	2.78	12.47	2.91	13.36	3.07	14.24	3.15	15.12	3.19	12.88	3.20	13.86	3.34	14.84	3.53	15.82	3.62	16.80	3.67
26	11.52	2.79	12.40	2.92	13.28	3.09	14.16	3.16	15.07	3.20	12.80	3.21	13.78	3.36	14.76	3.55	15.74	3.63	16.74	3.68
28	11.37	2.82	12.25	2.95	13.13	3.11	14.01	3.19	14.97	3.23	12.63	3.24	13.61	3.39	14.59	3.58	15.57	3.67	16.63	3.71
30	11.21	2.85	12.10	2.97	12.98	3.14	13.86	3.22	14.87	3.26	12.46	3.28	13.44	3.42	14.42	3.61	15.40	3.70	16.52	3.74
32	11.06	2.93	11.94	3.05	12.83	3.22	13.71	3.30	14.67	3.34	12.29	3.36	13.27	3.51	14.25	3.70	15.23	3.79	16.30	3.84
34	10.91	3.01	11.79	3.13	12.68	3.30	13.56	3.38	14.46	3.42	12.12	3.46	13.10	3.60	14.08	3.79	15.06	3.88	16.07	3.93
35	10.84	3.05	11.72	3.17	12.60	3.34	13.48	3.42	14.36	3.46	12.04	3.50	13.02	3.65	14.00	3.84	14.98	3.93	15.96	3.97
36	10.74	3.13	11.62	3.26	12.50	3.43	13.38	3.50	14.24	3.55	11.93	3.60	12.91	3.75	13.89	3.94	14.87	4.03	15.82	4.08
38	10.53	3.30	11.42	3.43	12.30	3.60	13.18	3.68	13.99	3.73	11.70	3.80	12.68	3.95	13.66	4.14	14.64	4.23	15.54	4.29
40	10.33	3.48	11.21	3.61	12.10	3.78	12.98	3.86	13.73	3.91	11.48	3.99	12.46	4.15	13.44	4.34	14.42	4.44	15.26	4.50

To	Total power of combined indoor units (110%)										Total power of combined indoor units (120%)									
	Ti										Ti									
	15/(21)		17/(24)		19/(27)		21/(29)		23/(31)		15/(21)		17/(24)		19/(27)		21/(29)		23/(31)	
	CAP	IPT	CAP	IPT	CAP	IPT	CAP	IPT	CAP	IPT	CAP	IPT	CAP	IPT	CAP	IPT	CAP	IPT	CAP	IPT
10	12.88	3.04	13.86	3.18	14.84	3.36	15.82	3.45	16.80	3.49	12.88	3.07	13.86	3.21	14.84	3.39	15.82	3.48	16.80	3.53
12	12.88	3.04	13.86	3.18	14.84	3.37	15.82	3.45	16.80	3.49	12.88	3.07	13.86	3.21	14.84	3.40	15.82	3.48	16.80	3.53
14	12.88	3.06	13.86	3.19	14.84	3.38	15.82	3.46	16.80	3.50	12.88	3.09	13.86	3.22	14.84	3.41	15.82	3.49	16.80	3.54
16	12.88	3.07	13.86	3.21	14.84	2.39	15.82	3.48	16.80	3.52	12.88	3.10	13.86	3.24	14.84	2.39	15.82	3.51	16.80	3.56
18	12.88	3.09	13.86	3.23	14.84	3.42	15.82	3.51	16.80	3.55	12.88	3.12	13.86	3.26	14.84	3.45	15.82	3.54	16.80	3.59
20	12.88	3.12	13.86	3.27	14.84	3.45	15.82	3.54	16.80	3.58	12.88	3.15	13.86	3.30	14.84	3.49	15.82	3.57	16.80	3.62
22	12.88	3.16	13.86	3.30	14.84	3.49	15.82	3.58	16.80	3.63	12.88	3.19	13.86	3.34	14.84	3.52	15.82	3.61	16.80	3.66
24	12.88	3.20	13.86	3.35	14.84	3.54	15.82	3.63	16.80	3.67	12.88	3.23	13.86	3.38	14.84	3.57	15.82	3.66	16.80	3.71
25	12.88	3.23	13.86	3.37	14.84	3.57	15.82	3.66	16.80	3.70	12.88	3.26	13.86	3.41	14.84	3.60	15.82	3.69	16.80	3.74
26	12.80	3.24	13.78	3.39	14.76	3.58	15.74	3.67	16.74	3.72	12.80	3.27	13.78	3.42	14.76	3.62	15.74	3.71	16.74	3.76
28	12.63	3.28	13.61	3.42	14.59	3.61	15.57	3.70	16.63	3.75	12.63	3.31	13.61	3.45	14.59	3.65	15.57	3.74	16.63	3.79
30	12.46	3.31	13.44	3.45	14.42	3.65	15.40	3.73	16.52	3.78	12.46	3.34	13.44	3.49	14.42	3.68	15.40	3.77	16.52	3.82
32	12.29	3.40	13.27	3.54	14.25	3.74	15.23	3.83	16.30	3.87	12.29	3.43	13.27	3.58	14.25	3.78	15.23	3.86	16.30	3.91
34	12.12	3.49	13.10	3.64	14.08	3.83	15.06	3.92	16.07	3.97	12.12	3.52	13.10	3.67	14.08	3.87	15.06	3.96	16.07	4.01
35	12.04	3.54	13.02	3.68	14.00	3.88	14.98	3.97	15.96	4.01	12.04	3.57	13.02	3.72	14.00	3.92	14.98	4.00	15.96	4.05
36	11.93	3.64	12.91	3.79	13.89	3.98	14.87	4.07	15.82	4.12	11.93	3.67	12.91	3.82	13.89	4.02	14.87	4.11	15.82	4.16
38	11.70	3.83	12.68	3.99	13.66	4.18	14.64	4.27	15.54	4.33	11.70	3.87	12.68	4.03	13.66	4.22	14.64	4.32	15.54	4.38
40	11.48	4.03	12.46	4.19	13.44	4.38	14.42	4.48	15.26	4.54	11.48	4.07	12.46	4.23	13.44	4.43	14.42	4.52	15.26	4.59

To	Total power of combined indoor units (130%)									
	Ti									
	15/(21)		17/(24)		19/(27)		21/(29)		23/(31)	
	CAP	IPT	CAP	IPT	CAP	IPT	CAP	IPT	CAP	IPT
10	12.88	3.10	13.86	3.24	14.84	3.43	15.82	3.51	16.80	3.56
12	12.88	3.10	13.86	3.24	14.84	3.44	15.82	3.52	16.80	3.56
14	12.88	3.12	13.86	3.25	14.84	3.44	15.82	3.53	16.80	3.57
16	12.88	3.13	13.86	3.27	14.84	2.39	15.82	3.54	16.80	3.59
18	12.88	3.15	13.86	3.29	14.84	3.49	15.82	3.58	16.80	3.62
20	12.88	3.18	13.86	3.33	14.84	3.52	15.82	3.61	16.80	3.65
22	12.88	3.23	13.86	3.37	14.84	3.56	15.82	3.65	16.80	3.70
24	12.88	3.27	13.86	3.41	14.84	3.61	15.82	3.70	16.80	3.74
25	12.88	3.29	13.86	3.44	14.84	3.64	15.82	3.73	16.80	3.78
26	12.80	3.31	13.78	3.46	14.76	3.65	15.74	3.74	16.74	3.79
28	12.63	3.34	13.61	3.49	14.59	3.69	15.57	3.78	16.63	3.82
30	12.46	3.37	13.44	3.52	14.42	3.72	15.40	3.81	16.52	3.86
32	12.29	3.46	13.27	3.62	14.25	3.81	15.23	3.90	16.30	3.95
34	12.12	3.56	13.10	3.71	14.08	3.91	15.06	4.00	16.07	4.05
35	12.04	3.61	13.02	3.76	14.00	3.96	14.98	4.04	15.96	4.09
36	11.93	3.71	12.91	3.86	13.89	4.06	14.87	4.15	15.82	4.20
38	11.70	3.91	12.68	4.07	13.66	4.26	14.64	4.36	15.54	4.42
40	11.48	4.11	12.46	4.27	13.44	4.47	14.42	4.57	15.26	4.63

RAS-6FSNY2E

To	Total power of combined indoor units (50%)										Total power of combined indoor units (60%)									
	Ti										Ti									
	15/(21)		17/(24)		19/(27)		21/(29)		23/(31)		15/(21)		17/(24)		19/(27)		21/(29)		23/(31)	
	CAP	IPT	CAP	IPT	CAP	IPT	CAP	IPT	CAP	IPT	CAP	IPT	CAP	IPT	CAP	IPT	CAP	IPT	CAP	IPT
10	6.90	1.67	7.52	1.74	8.06	1.84	8.60	1.89	9.22	1.91	8.28	1.99	9.02	2.08	9.67	2.20	10.32	2.26	11.07	2.29
12	6.90	1.67	7.52	1.74	8.06	1.85	8.60	1.89	9.22	1.91	8.28	1.99	9.02	2.08	9.67	2.21	10.32	2.26	11.07	2.29
14	6.90	1.67	7.52	1.75	8.06	1.85	8.60	1.89	9.22	1.92	8.28	2.00	9.02	2.09	9.67	2.21	10.32	2.27	11.07	2.29
16	6.90	1.68	7.52	1.76	8.06	2.39	8.60	1.90	9.22	1.93	8.28	2.01	9.02	2.10	9.67	2.39	10.32	2.28	11.07	2.31
18	6.90	1.69	7.52	1.77	8.06	1.87	8.60	1.92	9.22	1.95	8.28	2.03	9.02	2.12	9.67	2.24	10.32	2.30	11.07	2.33
20	6.90	1.71	7.52	1.79	8.06	1.89	8.60	1.94	9.22	1.96	8.28	2.05	9.02	2.14	9.67	2.26	10.32	2.32	11.07	2.35
22	6.90	1.73	7.52	1.81	8.06	1.91	8.60	1.96	9.22	1.99	8.28	2.07	9.02	2.16	9.67	2.29	10.32	2.34	11.07	2.38
24	6.90	1.75	7.52	1.83	8.06	1.94	8.60	1.99	9.22	2.01	8.28	2.10	9.02	2.19	9.67	2.32	10.32	2.38	11.07	2.41
25	6.90	1.77	7.52	1.85	8.06	1.96	8.60	2.00	9.22	2.03	8.28	2.11	9.02	2.21	9.67	2.34	10.32	2.39	11.07	2.43
26	6.88	1.78	7.50	1.86	8.04	1.96	8.59	2.01	9.21	2.04	8.26	2.12	9.00	2.22	9.65	2.35	10.30	2.41	11.05	2.44
28	6.85	1.80	7.47	1.87	8.01	1.98	8.56	2.03	9.18	2.06	8.22	2.15	8.97	2.24	9.62	2.37	10.27	2.43	11.01	2.46
30	6.82	1.81	7.44	1.89	7.98	2.00	8.53	2.05	9.15	2.07	8.18	2.17	8.93	2.26	9.58	2.39	10.23	2.45	10.97	2.48
32	6.73	1.86	7.35	1.94	7.89	2.05	8.43	2.10	9.05	2.12	8.07	2.23	8.82	2.32	9.47	2.45	10.12	2.51	10.86	2.54
34	6.63	1.91	7.25	1.99	7.80	2.10	8.34	2.15	8.96	2.17	7.96	2.29	8.70	2.38	9.36	2.51	10.01	2.57	10.75	2.60
35	6.59	1.94	7.21	2.02	7.75	2.13	8.29	2.17	8.91	2.20	7.90	2.32	8.65	2.41	9.30	2.54	9.95	2.60	10.70	2.63
36	6.54	1.99	7.15	2.07	7.69	2.18	8.20	2.23	8.76	2.26	7.85	2.38	8.57	2.48	9.23	2.61	9.84	2.67	10.51	2.70
38	6.45	2.10	7.02	2.18	7.56	2.29	8.01	2.34	8.45	2.37	7.74	2.51	8.43	2.61	9.08	2.74	9.62	2.80	10.14	2.84
40	6.36	2.21	6.90	2.30	7.44	2.40	7.83	2.45	8.14	2.49	7.63	2.64	8.28	2.74	8.93	2.87	9.39	2.93	9.77	2.98



To	Total power of combined indoor units (70%)										Total power of combined indoor units (80%)									
	Ti										Ti									
	15/(21)		17/(24)		19/(27)		21/(29)		23/(31)		15/(21)		17/(24)		19/(27)		21/(29)		23/(31)	
	CAP	IPT	CAP	IPT	CAP	IPT	CAP	IPT	CAP	IPT	CAP	IPT	CAP	IPT	CAP	IPT	CAP	IPT	CAP	IPT
10	9.66	2.36	10.52	2.46	11.28	2.60	12.04	2.67	12.91	2.70	11.04	2.76	12.03	2.88	12.90	3.04	13.76	3.12	14.76	3.16
12	9.66	2.36	10.52	2.46	11.28	2.61	12.04	2.67	12.91	2.70	11.04	2.76	12.03	2.88	12.90	3.05	13.76	3.12	14.76	3.16
14	9.66	2.37	10.52	2.47	11.28	2.62	12.04	2.68	12.91	2.71	11.04	2.77	12.03	2.89	12.90	3.06	13.76	3.13	14.76	3.17
16	9.66	2.38	10.52	2.48	11.28	2.39	12.04	2.69	12.91	2.73	11.04	2.78	12.03	2.91	12.90	2.39	13.76	3.15	14.76	3.19
18	9.66	2.39	10.52	2.50	11.28	2.65	12.04	2.72	12.91	2.75	11.04	2.80	12.03	2.92	12.90	3.10	13.76	3.18	14.76	3.22
20	9.66	2.42	10.52	2.53	11.28	2.67	12.04	2.74	12.91	2.77	11.04	2.83	12.03	2.96	12.90	3.13	13.76	3.20	14.76	3.24
22	9.66	2.45	10.52	2.56	11.28	2.70	12.04	2.77	12.91	2.81	11.04	2.86	12.03	2.99	12.90	3.16	13.76	3.24	14.76	3.28
24	9.66	2.48	10.52	2.59	11.28	2.74	12.04	2.81	12.91	2.84	11.04	2.90	12.03	3.03	12.90	3.20	13.76	3.28	14.76	3.32
25	9.66	2.50	10.52	2.61	11.28	2.76	12.04	2.83	12.91	2.87	11.04	2.92	12.03	3.05	12.90	3.23	13.76	3.31	14.76	3.35
26	9.63	2.51	10.50	2.62	11.26	2.77	12.02	2.84	12.89	2.88	11.01	2.93	12.00	3.07	12.87	3.24	13.74	3.32	14.73	3.37
28	9.59	2.54	10.46	2.65	11.22	2.80	11.98	2.87	12.85	2.90	10.96	2.97	11.95	3.10	12.82	3.27	13.69	3.35	14.68	3.40
30	9.55	2.56	10.42	2.67	11.18	2.82	11.94	2.89	12.80	2.93	10.91	2.99	11.90	3.12	12.77	3.30	13.64	3.38	14.63	3.42
32	9.42	2.63	10.29	2.74	11.05	2.89	11.80	2.96	12.67	3.00	10.76	3.08	11.76	3.21	12.62	3.38	13.49	3.46	14.48	3.51
34	9.29	2.70	10.16	2.82	10.92	2.97	11.67	3.03	12.54	3.07	10.61	3.16	11.61	3.29	12.47	3.47	13.34	3.55	14.33	3.59
35	9.22	2.74	10.09	2.85	10.85	3.00	11.61	3.07	12.48	3.11	10.54	3.20	11.53	3.34	12.40	3.51	13.27	3.59	14.26	3.63
36	9.16	2.82	10.00	2.93	10.76	3.08	11.48	3.15	12.26	3.19	10.47	3.29	11.43	3.43	12.30	3.60	13.12	3.68	14.01	3.73
38	9.03	2.97	9.83	3.09	10.59	3.24	11.22	3.31	11.83	3.35	10.32	3.47	11.23	3.61	12.10	3.79	12.82	3.87	13.52	3.92
40	8.90	3.12	9.66	3.24	10.42	3.39	10.96	3.47	11.39	3.52	10.17	3.65	11.04	3.79	11.90	3.97	12.52	4.06	13.02	4.11

To	Total power of combined indoor units (90%)										Total power of combined indoor units (100%)									
	Ti										Ti									
	15/(21)		17/(24)		19/(27)		21/(29)		23/(31)		15/(21)		17/(24)		19/(27)		21/(29)		23/(31)	
	CAP	IPT	CAP	IPT	CAP	IPT	CAP	IPT	CAP	IPT	CAP	IPT	CAP	IPT	CAP	IPT	CAP	IPT	CAP	IPT
10	12.42	3.15	13.53	3.30	14.51	3.48	15.48	3.57	16.60	3.62	13.80	3.63	15.04	3.79	16.12	4.00	17.21	4.10	18.45	4.16
12	12.42	3.15	13.53	3.30	14.51	3.49	15.48	3.57	16.60	3.62	13.80	3.63	15.04	3.79	16.12	4.01	17.21	4.11	18.45	4.16
14	12.42	3.17	13.53	3.30	14.51	3.50	15.48	3.58	16.60	3.63	13.80	3.64	15.04	3.80	16.12	4.02	17.21	4.12	18.45	4.17
16	12.42	3.18	13.53	3.33	14.51	2.39	15.48	3.60	16.60	3.65	13.80	3.66	15.04	3.82	16.12	2.39	17.21	4.14	18.45	4.19
18	12.42	3.20	13.53	3.35	14.51	3.54	15.48	3.63	16.60	3.68	13.80	3.68	15.04	3.85	16.12	4.07	17.21	4.18	18.45	4.23
20	12.42	3.24	13.53	3.39	14.51	3.58	15.48	3.67	16.60	3.71	13.80	3.72	15.04	3.89	16.12	4.11	17.21	4.21	18.45	4.26
22	12.42	3.28	13.53	3.42	14.51	3.61	15.48	3.71	16.60	3.76	13.80	3.77	15.04	3.93	16.12	4.15	17.21	4.26	18.45	4.32
24	12.42	3.32	13.53	3.47	14.51	3.67	15.48	3.76	16.60	3.81	13.80	3.81	15.04	3.99	16.12	4.22	17.21	4.32	18.45	4.37
25	12.42	3.35	13.53	3.50	14.51	3.70	15.48	3.79	16.60	3.84	13.80	3.85	15.04	4.02	16.12	4.25	17.21	4.35	18.45	4.41
26	12.39	3.36	13.50	3.51	14.48	3.71	15.46	3.80	16.57	3.85	13.76	3.86	15.00	4.04	16.09	4.27	17.17	4.37	18.41	4.43
28	12.33	3.40	13.45	3.55	14.42	3.75	15.40	3.84	16.52	3.89	13.70	3.90	14.94	4.07	16.03	4.31	17.11	4.41	18.35	4.47
30	12.28	3.43	13.39	3.58	14.37	3.78	15.35	3.87	16.46	3.92	13.64	3.94	14.88	4.11	15.97	4.34	17.05	4.45	18.29	4.50
32	12.11	3.52	13.22	3.67	14.20	3.87	15.18	3.97	16.29	4.02	13.45	4.05	14.69	4.22	15.78	4.45	16.86	4.56	18.10	4.62
34	11.94	3.62	13.06	3.77	14.03	3.97	15.01	4.06	16.13	4.11	13.27	4.16	14.51	4.33	15.59	4.56	16.68	4.67	17.92	4.73
35	11.86	3.67	12.97	3.82	13.95	4.02	14.93	4.11	16.04	4.16	13.18	4.21	14.42	4.39	15.50	4.62	16.59	4.72	17.83	4.78
36	11.77	3.77	12.86	3.92	13.84	4.12	14.76	4.22	15.76	4.27	13.08	4.33	14.29	4.51	15.38	4.74	16.40	4.85	17.52	4.91
38	11.61	3.97	12.64	4.13	13.62	4.33	14.42	4.43	15.21	4.49	12.90	4.57	14.04	4.75	15.13	4.98	16.03	5.09	16.90	5.16
40	11.44	4.18	12.42	4.34	13.39	4.54	14.09	4.64	14.65	4.71	12.71	4.81	13.80	4.99	14.88	5.22	15.66	5.34	16.28	5.41

To	Total power of combined indoor units (110%)										Total power of combined indoor units (120%)									
	Ti										Ti									
	15/(21)		17/(24)		19/(27)		21/(29)		23/(31)		15/(21)		17/(24)		19/(27)		21/(29)		23/(31)	
	CAP	IPT	CAP	IPT	CAP	IPT	CAP	IPT	CAP	IPT	CAP	IPT	CAP	IPT	CAP	IPT	CAP	IPT	CAP	IPT
10	13.80	3.66	15.04	3.83	16.12	4.04	17.21	4.14	18.45	4.20	13.80	3.70	15.04	3.86	16.12	4.08	17.21	4.19	18.45	4.24
12	13.80	3.66	15.04	3.83	16.12	4.05	17.21	4.15	18.45	4.20	13.80	3.70	15.04	3.86	16.12	4.09	17.21	4.19	18.45	4.24
14	13.80	3.68	15.04	3.84	16.12	4.06	17.21	4.16	18.45	4.21	13.80	3.71	15.04	3.87	16.12	4.10	17.21	4.20	18.45	4.26
16	13.80	3.70	15.04	3.86	16.12	2.39	17.21	4.18	18.45	4.24	13.80	3.73	15.04	3.90	16.12	2.39	17.21	4.22	18.45	4.28
18	13.80	3.72	15.04	3.89	16.12	4.11	17.21	4.22	18.45	4.27	13.80	3.76	15.04	3.92	16.12	4.16	17.21	4.26	18.45	4.32
20	13.80	3.76	15.04	3.93	16.12	4.16	17.21	4.26	18.45	4.31	13.80	3.79	15.04	3.97	16.12	4.20	17.21	4.30	18.45	4.35
22	13.80	3.81	15.04	3.97	16.12	4.20	17.21	4.30	18.45	4.36	13.80	3.84	15.04	4.01	16.12	4.24	17.21	4.35	18.45	4.41
24	13.80	3.85	15.04	4.03	16.12	4.26	17.21	4.36	18.45	4.42	13.80	3.89	15.04	4.07	16.12	4.30	17.21	4.41	18.45	4.46
25	13.80	3.88	15.04	4.06	16.12	4.29	17.21	4.40	18.45	4.46	13.80	3.92	15.04	4.10	16.12	4.34	17.21	4.44	18.45	4.50
26	13.76	3.90	15.00	4.08	16.09	4.31	17.17	4.42	18.41	4.47	13.76	3.94	15.00	4.12	16.09	4.35	17.17	4.46	18.41	4.52
28	13.70	3.94	14.94	4.12	16.03	4.35	17.11	4.45	18.35	4.51	13.70	3.98	14.94	4.16	16.03	4.39	17.11	4.50	18.35	4.56
30	13.64	3.98	14.88	4.15	15.97	4.39	17.05	4.49	18.29	4.55	13.64	4.02	14.88	4.19	15.97	4.43	17.05	4.54	18.29	4.59
32	13.45	4.09	14.69	4.26	15.78	4.50	16.86	4.60	18.10	4.66	13.45	4.13	14.69	4.31	15.78	4.54	16.86	4.65	18.10	4.71
34	13.27	4.20	14.51	4.38	15.59	4.61	16.68	4.72	17.92	4.77	13.27	4.24	14.51	4.42	15.59	4.66	16.68	4.76	17.92	4.82
35	13.18	4.25	14.42	4.43	15.50	4.67	16.59	4.77	17.83	4.83	13.18	4.30	14.42	4.48	15.50	4.71	16.59	4.82	17.83	4.88
36	13.08	4.38	14.29	4.55	15.38	4.79	16.40	4.89	17.52	4.96	13.08	4.42	14.29	4.60	15.38	4.83	16.40	4.94	17.52	5.01
38	12.90	4.61	14.04	4.80	15.13	5.03	16.03	5.14	16.90	5.21	12.90	4.66	14.04	4.84	15.13	5.08	16.03	5.19	16.90	5.26
40	12.71	4.85	13.80	5.04	14.88	5.27	15.66	5.39	16.28	5.47	12.71	4.90	13.80	5.09	14.88	5.33	15.66	5.44	16.28	5.52

To	Total power of combined indoor units (130%)									
	Ti									
	15/(21)		17/(24)		19/(27)		21/(29)		23/(31)	
	CAP	IPT	CAP	IPT	CAP	IPT	CAP	IPT	CAP	IPT
10	13.80	3.73	15.04	3.90	16.12	4.12	17.21	4.23	18.45	4.29
12	13.80	3.73	15.04	3.90	16.12	4.13	17.21	4.23	18.45	4.29
14	13.80	3.75	15.04	3.91	16.12	4.14	17.21	4.24	18.45	4.30
16	13.80	3.77	15.04	3.94	16.12	2.39	17.21	4.26	18.45	4.32
18	13.80	3.79	15.04	3.96	16.12	4.20	17.21	4.30	18.45	4.36
20	13.80	3.83	15.04	4.01	16.12	4.24	17.21	4.34	18.45	4.39
22	13.80	3.88	15.04	4.05	16.12	4.28	17.21	4.39	18.45	4.45
24	13.80	3.93	15.04	4.11	16.12	4.34	17.21	4.45	18.45	4.51
25	13.80	3.96	15.04	4.14	16.12	4.38	17.21	4.48	18.45	4.54
26	13.76	3.98	15.00	4.16	16.09	4.40	17.17	4.50	18.41	4.56
28	13.70	4.02	14.94	4.20	16.03	4.44	17.11	4.54	18.35	4.60
30	13.64	4.06	14.88	4.24	15.97	4.47	17.05	4.58	18.29	4.64
32	13.45	4.17	14.69	4.35	15.78	4.59	16.86	4.69	18.10	4.75
34	13.27	4.28	14.51	4.46	15.59	4.70	16.68	4.81	17.92	4.87
35	13.18	4.34	14.42	4.52	15.50	4.76	16.59	4.87	17.83	4.93
36	13.08	4.46	14.29	4.64	15.38	4.88	16.40	4.99	17.52	5.06
38	12.90	4.70	14.04	4.89	15.13	5.13	16.03	5.24	16.90	5.32
40	12.71	4.95	13.80	5.14	14.88	5.38	15.66	5.50	16.28	5.58

4

4.3 Heating capacity tables

The following tables show the capacity characteristics of the outdoor unit corresponding to the total power of the indoor units combined, in standard conditions with horizontal, 7.5 m long refrigerant pipes.

Temperature conditions	
Indoor air inlet temperature	20 °C DB
Outdoor air inlet temperature	7 °C DB
	6 °C WB



NOTE

DB: dry bulb; WB: wet bulb.

4.3.1 Heating capacity curve

A: Heating capacity (kW).

B: Total horsepower of combined indoor units (HP).

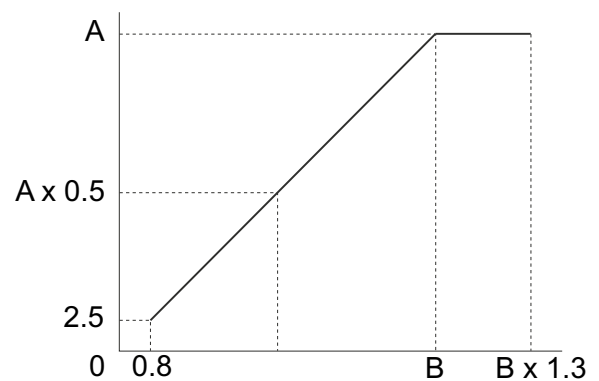

Model	A (kW)	B (HP)
RAS-4FS(V)N(Y)2E	12.5	4
RAS-5FS(V)N(Y)2E	16.0	5
RAS-6FS(V)N(Y)2E	18.0	6

4.3.2 Nominal heating capacity tables

Heating capacity at conditions: Indoor air inlet: 20 °C DB; Outdoor air inlet: 7/6 °C (DB/WB).

◆ RAS-(4-6)FSVN2E

Total horsepower of combined indoor units (%)	Outdoor units HP					
	RAS-4FSVN2E		RAS-5FSVN2E		RAS-6FSVN2E	
	Heating capacity (kW)	Heating input (kW)	Heating capacity (kW)	Heating input (kW)	Heating capacity (kW)	Heating input (kW)
130	12.50	2.70	16.00	3.74	18.00	4.36
120	12.50	2.82	16.00	3.91	18.00	4.56
110	12.50	2.91	16.00	4.03	18.00	4.70
100	12.50	3.03	16.00	4.20	18.00	4.90
90	11.25	2.67	14.40	3.70	16.20	4.31
80	10.00	2.33	12.80	3.23	14.40	3.77
70	8.75	2.00	11.20	2.77	12.60	3.23
60	7.50	1.73	9.60	2.39	10.80	2.79
50	6.25	1.45	8.00	2.02	9.00	2.35

◆ RAS-(4-6)FSNY2E

Total horsepower of combined indoor units (%)	Outdoor units HP					
	RAS-4FSNY2E		RAS-5FSNY2E		RAS-6FSNY2E	
	Heating capacity (kW)	Heating input (kW)	Heating capacity (kW)	Heating input (kW)	Heating capacity (kW)	Heating input (kW)
130	12.50	2.67	16.00	3.70	18.00	4.32
120	12.50	2.79	16.00	3.87	18.00	4.51
110	12.50	2.88	16.00	3.99	18.00	4.66
100	12.50	3.00	16.00	4.16	18.00	4.85
90	11.25	2.64	14.40	3.66	16.20	4.27
80	10.00	2.31	12.80	3.20	14.40	3.73
70	8.75	1.98	11.20	2.75	12.60	3.20
60	7.50	1.71	9.60	2.37	10.80	2.76
50	6.25	1.44	8.00	2.00	9.00	2.33

4

4.3.3 Heating capacity tables according to total power of combined indoor units



NOTE

- *To*: Outdoor air inlet temperature (°C WB)
- *Ti*: Indoor air inlet temperature (°C DB)
- *CAP*: Capacity at compressor maximum frequency (kW)
- *IPT*: Input power (kW)

◆ RAS-(4-6)FSVN2E

RAS-4FSVN2E

To	Total power of combined indoor units (50%)										Total power of combined indoor units (60%)									
	Ti										Ti									
	16		18		20		22		24		16		18		20		22		24	
	CAP	IPT	CAP	IPT	CAP	IPT	CAP	IPT	CAP	IPT	CAP	IPT	CAP	IPT	CAP	IPT	CAP	IPT	CAP	IPT
-20	3.69	1.18	3.56	1.23	3.50	1.29	3.44	1.35	3.38	1.41	4.43	1.40	4.28	1.46	4.20	1.53	4.13	1.60	4.05	1.68
-17	3.80	1.19	3.71	1.24	3.65	1.30	3.59	1.36	3.53	1.42	4.56	1.41	4.46	1.47	4.38	1.55	4.31	1.61	4.23	1.69
-15	3.88	1.20	3.81	1.25	3.75	1.31	3.69	1.37	3.63	1.43	4.65	1.42	4.58	1.49	4.50	1.56	4.43	1.63	4.35	1.70
-13	4.00	1.21	3.96	1.26	3.90	1.32	3.84	1.38	3.78	1.44	4.80	1.44	4.76	1.50	4.68	1.57	4.61	1.64	4.53	1.72
-11	4.13	1.22	4.11	1.27	4.05	1.33	3.99	1.39	3.93	1.45	4.95	1.45	4.94	1.51	4.86	1.58	4.79	1.65	4.71	1.73
-10	4.19	1.23	4.19	1.28	4.13	1.34	4.06	1.40	4.00	1.46	5.03	1.46	5.03	1.52	4.95	1.59	4.88	1.66	4.80	1.74
-9	4.30	1.24	4.30	1.29	4.24	1.35	4.19	1.41	4.14	1.47	5.16	1.47	5.16	1.53	5.09	1.61	5.03	1.68	4.97	1.75
-7	4.53	1.25	4.53	1.30	4.46	1.36	4.44	1.42	4.41	1.49	5.43	1.48	5.43	1.55	5.36	1.62	5.33	1.69	5.30	1.76
-6	4.64	1.26	4.64	1.31	4.58	1.37	4.56	1.43	4.55	1.50	5.57	1.50	5.57	1.56	5.49	1.63	5.48	1.70	5.46	1.78
-5	4.75	1.27	4.75	1.32	4.69	1.38	4.69	1.44	4.69	1.51	5.70	1.51	5.70	1.57	5.63	1.64	5.63	1.71	5.63	1.79
-3	5.03	1.28	5.00	1.33	4.96	1.39	4.96	1.45	4.94	1.52	6.03	1.52	6.00	1.58	5.96	1.65	5.96	1.72	5.93	1.80
-1	5.30	1.29	5.25	1.34	5.24	1.40	5.24	1.46	5.19	1.53	6.36	1.53	6.30	1.60	6.29	1.67	6.29	1.74	6.23	1.81
0	5.44	1.30	5.38	1.35	5.38	1.41	5.38	1.47	5.31	1.54	6.53	1.54	6.45	1.61	6.45	1.68	6.45	1.75	6.38	1.82
1	5.59	1.31	5.53	1.36	5.53	1.42	5.53	1.48	5.46	1.55	6.71	1.56	6.63	1.62	6.63	1.69	6.63	1.76	6.56	1.84
3	5.89	1.32	5.83	1.37	5.83	1.43	5.83	1.49	5.76	1.56	7.07	1.57	6.99	1.63	6.99	1.70	6.99	1.77	6.92	1.85
5	6.19	1.33	6.13	1.38	6.13	1.44	6.13	1.50	6.06	1.57	7.43	1.58	7.35	1.64	7.35	1.72	7.35	1.78	7.28	1.86
6	6.31	1.34	6.25	1.39	6.25	1.45	6.25	1.51	6.19	1.58	7.58	1.59	7.50	1.66	7.50	1.73	7.50	1.80	7.43	1.87
7	6.45	1.35	6.41	1.40	6.39	1.46	6.39	1.52	6.33	1.59	7.74	1.61	7.69	1.67	7.67	1.74	7.67	1.81	7.59	1.88
9	6.73	1.36	6.72	1.41	6.67	1.47	6.67	1.53	6.61	1.60	8.08	1.62	8.06	1.68	8.01	1.75	8.01	1.82	7.93	1.90
10	6.88	1.37	6.88	1.42	6.81	1.48	6.81	1.54	6.75	1.61	8.25	1.63	8.25	1.69	8.18	1.76	8.18	1.83	8.10	1.91
11	6.94	1.38	6.91	1.43	6.86	1.50	6.84	1.55	6.79	1.62	8.33	1.64	8.30	1.70	8.24	1.78	8.21	1.84	8.15	1.92
14	7.13	1.39	7.03	1.45	7.01	1.51	6.91	1.56	6.90	1.63	8.55	1.65	8.43	1.72	8.42	1.79	8.30	1.86	8.28	1.93
15	7.19	1.40	7.06	1.46	7.06	1.52	6.94	1.57	6.94	1.64	8.63	1.67	8.48	1.73	8.48	1.80	8.33	1.87	8.33	1.94

To	Total power of combined indoor units (70%)										Total power of combined indoor units (80%)									
	Ti										Ti									
	16		18		20		22		24		16		18		20		22		24	
	CAP	IPT	CAP	IPT	CAP	IPT	CAP	IPT	CAP	IPT	CAP	IPT	CAP	IPT	CAP	IPT	CAP	IPT	CAP	IPT
-20	5.16	1.62	4.99	1.69	4.90	1.78	4.81	1.86	4.73	1.94	5.90	1.89	5.70	1.98	5.60	2.07	5.50	2.17	5.40	2.27
-17	5.32	1.63	5.20	1.71	5.11	1.79	5.02	1.87	4.94	1.96	6.08	1.91	5.94	1.99	5.84	2.09	5.74	2.18	5.64	2.28
-15	5.43	1.65	5.34	1.72	5.25	1.80	5.16	1.88	5.08	1.97	6.20	1.92	6.10	2.01	6.00	2.10	5.90	2.20	5.80	2.30
-13	5.60	1.66	5.55	1.74	5.46	1.82	5.37	1.90	5.29	1.99	6.40	1.94	6.34	2.02	6.24	2.12	6.14	2.21	6.04	2.32
-11	5.78	1.68	5.76	1.75	5.67	1.83	5.58	1.91	5.50	2.00	6.60	1.96	6.58	2.04	6.48	2.14	6.38	2.23	6.28	2.33
-10	5.86	1.69	5.86	1.76	5.78	1.85	5.69	1.93	5.60	2.01	6.70	1.97	6.70	2.06	6.60	2.15	6.50	2.25	6.40	2.35
-9	6.02	1.70	6.02	1.78	5.93	1.86	5.86	1.94	5.79	2.03	6.88	1.99	6.88	2.07	6.78	2.17	6.70	2.26	6.62	2.37
-7	6.34	1.72	6.34	1.79	6.25	1.87	6.21	1.95	6.18	2.04	7.24	2.01	7.24	2.09	7.14	2.19	7.10	2.28	7.06	2.38
-6	6.49	1.73	6.49	1.81	6.41	1.89	6.39	1.97	6.37	2.06	7.42	2.02	7.42	2.11	7.32	2.20	7.30	2.30	7.28	2.40
-5	6.65	1.75	6.65	1.82	6.56	1.90	6.56	1.98	6.56	2.07	7.60	2.04	7.60	2.12	7.50	2.22	7.50	2.31	7.50	2.42
-3	7.04	1.76	7.00	1.83	6.95	1.92	6.95	2.00	6.91	2.08	8.04	2.05	8.00	2.14	7.94	2.24	7.94	2.33	7.90	2.43
-1	7.42	1.77	7.35	1.85	7.33	1.93	7.33	2.01	7.26	2.10	8.48	2.07	8.40	2.15	8.38	2.25	8.38	2.34	8.30	2.45
0	7.61	1.79	7.53	1.86	7.53	1.94	7.53	2.02	7.44	2.11	8.70	2.09	8.60	2.17	8.60	2.27	8.60	2.36	8.50	2.46
1	7.82	1.80	7.74	1.88	7.74	1.96	7.74	2.04	7.65	2.13	8.94	2.10	8.84	2.19	8.84	2.28	8.84	2.38	8.74	2.48
3	8.24	1.82	8.16	1.89	8.16	1.97	8.16	2.05	8.07	2.14	9.42	2.12	9.32	2.20	9.32	2.30	9.32	2.39	9.22	2.50
5	8.66	1.83	8.58	1.90	8.58	1.99	8.58	2.07	8.49	2.15	9.90	2.14	9.80	2.22	9.80	2.32	9.80	2.41	9.70	2.51
6	8.84	1.84	8.75	1.92	8.75	2.00	8.75	2.08	8.66	2.17	10.10	2.15	10.00	2.24	10.00	2.33	10.00	2.43	9.90	2.53
7	9.03	1.86	8.97	1.93	8.95	2.01	8.95	2.09	8.86	2.18	10.33	2.17	10.25	2.25	10.23	2.35	10.23	2.44	10.13	2.55
9	9.43	1.87	9.41	1.95	9.34	2.03	9.34	2.11	9.25	2.20	10.78	2.19	10.75	2.27	10.68	2.37	10.68	2.46	10.58	2.56
10	9.63	1.89	9.63	1.96	9.54	2.04	9.54	2.12	9.45	2.21	11.00	2.20	11.00	2.29	10.90	2.38	10.90	2.48	10.80	2.58
11	9.71	1.90	9.68	1.97	9.61	2.06	9.57	2.14	9.50	2.22	11.10	2.22	11.06	2.30	10.98	2.40	10.94	2.49	10.86	2.59
14	9.98	1.91	9.84	1.99	9.82	2.07	9.68	2.15	9.66	2.24	11.40	2.23	11.24	2.32	11.22	2.41	11.06	2.51	11.04	2.61
15	10.06	1.93	9.89	2.00	9.89	2.08	9.71	2.16	9.71	2.25	11.50	2.25	11.30	2.33	11.30	2.43	11.10	2.52	11.10	2.63

To	Total power of combined indoor units (90%)										Total power of combined indoor units (100%)									
	Ti										Ti									
	16		18		20		22		24		16		18		20		22		24	
	CAP	IPT	CAP	IPT	CAP	IPT	CAP	IPT	CAP	IPT	CAP	IPT	CAP	IPT	CAP	IPT	CAP	IPT	CAP	IPT
-20	6.64	2.16	6.41	2.26	6.30	2.37	6.19	2.47	6.08	2.59	7.38	2.46	7.13	2.57	7.00	2.69	6.88	2.81	6.75	2.95
-17	6.84	2.18	6.68	2.28	6.57	2.39	6.46	2.49	6.35	2.61	7.60	2.48	7.43	2.59	7.30	2.71	7.18	2.83	7.05	2.97
-15	6.98	2.20	6.86	2.29	6.75	2.41	6.64	2.51	6.53	2.63	7.75	2.50	7.63	2.61	7.50	2.73	7.38	2.85	7.25	2.99
-13	7.20	2.22	7.13	2.31	7.02	2.42	6.91	2.53	6.80	2.65	8.00	2.52	7.93	2.63	7.80	2.75	7.68	2.88	7.55	3.01
-11	7.43	2.24	7.40	2.33	7.29	2.44	7.18	2.55	7.07	2.67	8.25	2.54	8.23	2.65	8.10	2.78	7.98	2.90	7.85	3.03
-10	7.54	2.25	7.54	2.35	7.43	2.46	7.31	2.57	7.20	2.69	8.38	2.56	8.38	2.67	8.25	2.80	8.13	2.92	8.00	3.05
-9	7.74	2.27	7.74	2.37	7.63	2.48	7.54	2.59	7.45	2.70	8.60	2.58	8.60	2.69	8.48	2.82	8.38	2.94	8.28	3.07
-7	8.15	2.29	8.15	2.39	8.03	2.50	7.99	2.61	7.94	2.72	9.05	2.60	9.05	2.71	8.93	2.84	8.88	2.96	8.83	3.09
-6	8.35	2.31	8.35	2.41	8.24	2.52	8.21	2.62	8.19	2.74	9.28	2.63	9.28	2.73	9.15	2.86	9.13	2.98	9.10	3.12
-5	8.55	2.33	8.55	2.43	8.44	2.54	8.44	2.64	8.44	2.76	9.50	2.65	9.50	2.76	9.38	2.88	9.38	3.00	9.38	3.14
-3	9.05	2.35	9.00	2.44	8.93	2.55	8.93	2.66	8.89	2.78	10.05	2.67	10.00	2.78	9.93	2.90	9.93	3.02	9.88	3.16
-1	9.54	2.37	9.45	2.46	9.43	2.57	9.43	2.68	9.34	2.80	10.60	2.69	10.50	2.80	10.48	2.92	10.48	3.05	10.38	3.18
0	9.79	2.39	9.68	2.48	9.68	2.59	9.68	2.70	9.56	2.82	10.88	2.71	10.75	2.82	10.75	2.95	10.75	3.07	10.63	3.20
1	10.06	2.40	9.95	2.50	9.95	2.61	9.95	2.72	9.83	2.83	11.18	2.73	11.05	2.84	11.05	2.97	11.05	3.09	10.93	3.22
3	10.60	2.42	10.49	2.52	10.49	2.63	10.49	2.74	10.37	2.85	11.78	2.75	11.65	2.86	11.65	2.99	11.65	3.11	11.53	3.24
5	11.14	2.44	11.03	2.54	11.03	2.65	11.03	2.75	10.91	2.87	12.38	2.77	12.25	2.88	12.25	3.01	12.25	3.13	12.13	3.26
6	11.36	2.46	11.25	2.56	11.25	2.67	11.25	2.77	11.14	2.89	12.63	2.80	12.50	2.90	12.50	3.03	12.50	3.15	12.38	3.28
7	11.62	2.48	11.53	2.57	11.50	2.69	11.50	2.79	11.39	2.91	12.91	2.82	12.81	2.93	12.78	3.05	12.78	3.17	12.66	3.31
9	12.12	2.50	12.09	2.59	12.01	2.70	12.01	2.81	11.90	2.93	13.47	2.84	13.44	2.95	13.34	3.07	13.34	3.19	13.22	3.33
10	12.38	2.52	12.38	2.61	12.26	2.72	12.26	2.83	12.15	2.95	13.75	2.86	13.75	2.97	13.63	3.09	13.63	3.22	13.50	3.35
11	12.49	2.53	12.44	2.63	12.35	2.74	12.31	2.85	12.22	2.97	13.88	2.88	13.83	2.99	13.73	3.11	13.68	3.24	13.58	3.37
14	12.83	2.55	12.65	2.65	12.62	2.76	12.44	2.87	12.42	2.98	14.25	2.90	14.05	3.01	14.03	3.14	13.83	3.26	13.80	3.39
15	12.94	2.57	12.71	2.67	12.71	2.78	12.49	2.89	12.49	3.00	14.38	2.92	14.13	3.03	14.13	3.16	13.88	3.28	13.88	3.41

4

To	Total power of combined indoor units (110%)										Total power of combined indoor units (120%)									
	Ti										Ti									
	16		18		20		22		24		16		18		20		22		24	
	CAP	IPT	CAP	IPT	CAP	IPT	CAP	IPT	CAP	IPT	CAP	IPT	CAP	IPT	CAP	IPT	CAP	IPT	CAP	IPT
-20	7.38	2.36	7.13	2.46	7.00	2.58	6.88	2.70	6.75	2.83	7.38	2.28	7.13	2.39	7.00	2.50	6.88	2.62	6.75	2.74
-17	7.60	2.38	7.43	2.48	7.30	2.60	7.18	2.72	7.05	2.85	7.60	2.30	7.43	2.41	7.30	2.52	7.18	2.63	7.05	2.76
-15	7.75	2.40	7.63	2.50	7.50	2.62	7.38	2.74	7.25	2.87	7.75	2.32	7.63	2.43	7.50	2.54	7.38	2.65	7.25	2.78
-13	8.00	2.42	7.93	2.52	7.80	2.64	7.68	2.76	7.55	2.89	8.00	2.34	7.93	2.44	7.80	2.56	7.68	2.67	7.55	2.80
-11	8.25	2.44	8.23	2.54	8.10	2.66	7.98	2.78	7.85	2.91	8.25	2.36	8.23	2.46	8.10	2.58	7.98	2.69	7.85	2.82
-10	8.38	2.46	8.38	2.56	8.25	2.68	8.13	2.80	8.00	2.93	8.38	2.38	8.38	2.48	8.25	2.60	8.13	2.71	8.00	2.84
-9	8.60	2.48	8.60	2.58	8.48	2.71	8.38	2.82	8.28	2.95	8.60	2.40	8.60	2.50	8.48	2.62	8.38	2.73	8.28	2.86
-7	9.05	2.50	9.05	2.61	8.93	2.73	8.88	2.84	8.83	2.97	9.05	2.42	9.05	2.52	8.93	2.64	8.88	2.75	8.83	2.88
-6	9.28	2.52	9.28	2.63	9.15	2.75	9.13	2.86	9.10	2.99	9.28	2.44	9.28	2.54	9.15	2.66	9.13	2.77	9.10	2.90
-5	9.50	2.54	9.50	2.65	9.38	2.77	9.38	2.88	9.38	3.01	9.50	2.46	9.50	2.56	9.38	2.68	9.38	2.79	9.38	2.92
-3	10.05	2.56	10.00	2.67	9.93	2.79	9.93	2.90	9.88	3.03	10.05	2.48	10.00	2.58	9.93	2.70	9.93	2.81	9.88	2.94
-1	10.60	2.58	10.50	2.69	10.48	2.81	10.48	2.92	10.38	3.05	10.60	2.50	10.50	2.60	10.48	2.72	10.48	2.83	10.38	2.96
0	10.88	2.60	10.75	2.71	10.75	2.83	10.75	2.94	10.63	3.07	10.88	2.52	10.75	2.62	10.75	2.74	10.75	2.85	10.63	2.98
1	11.18	2.62	11.05	2.73	11.05	2.85	11.05	2.96	10.93	3.09	11.18	2.54	11.05	2.64	11.05	2.76	11.05	2.87	10.93	3.00
3	11.78	2.64	11.65	2.75	11.65	2.87	11.65	2.98	11.53	3.11	11.78	2.56	11.65	2.66	11.65	2.78	11.65	2.89	11.53	3.02
5	12.38	2.66	12.25	2.77	12.25	2.89	12.25	3.00	12.13	3.13	12.38	2.58	12.25	2.68	12.25	2.80	12.25	2.91	12.13	3.04
6	12.63	2.68	12.50	2.79	12.50	2.91	12.50	3.03	12.38	3.15	12.63	2.60	12.50	2.70	12.50	2.82	12.50	2.93	12.38	3.05
7	12.91	2.70	12.81	2.81	12.78	2.93	12.78	3.05	12.66	3.17	12.91	2.62	12.81	2.72	12.78	2.84	12.78	2.95	12.66	3.07
9	13.47	2.72	13.44	2.83	13.34	2.95	13.34	3.07	13.22	3.19	13.47	2.64	13.44	2.74	13.34	2.86	13.34	2.97	13.22	3.09
10	13.75	2.74	13.75	2.85	13.63	2.97	13.63	3.09	13.50	3.21	13.75	2.66	13.75	2.76	13.63	2.88	13.63	2.99	13.50	3.11
11	13.88	2.76	13.83	2.87	13.73	2.99	13.68	3.11	13.58	3.23	13.88	2.68	13.83	2.78	13.73	2.90	13.68	3.01	13.58	3.13
14	14.25	2.79	14.05	2.89	14.03	3.01	13.83	3.13	13.80	3.26	14.25	2.70	14.05	2.80	14.03	2.92	13.83	3.03	13.80	3.15
15	14.38	2.81	14.13	2.91	14.13	3.03	13.88	3.15	13.88	3.28	14.38	2.72	14.13	2.82	14.13	2.94	13.88	3.05	13.88	3.17

To	Total power of combined indoor units (130%)									
	Ti									
	16		18		20		22		24	
	CAP	IPT	CAP	IPT	CAP	IPT	CAP	IPT	CAP	IPT
-20	7.38	2.19	7.13	2.28	7.00	2.39	6.88	2.50	6.75	2.62
-17	7.60	2.20	7.43	2.30	7.30	2.41	7.18	2.52	7.05	2.64
-15	7.75	2.22	7.63	2.32	7.50	2.43	7.38	2.54	7.25	2.66
-13	8.00	2.24	7.93	2.34	7.80	2.45	7.68	2.56	7.55	2.68
-11	8.25	2.26	8.23	2.36	8.10	2.47	7.98	2.58	7.85	2.70
-10	8.38	2.28	8.38	2.38	8.25	2.49	8.13	2.60	8.00	2.72
-9	8.60	2.30	8.60	2.40	8.48	2.51	8.38	2.62	8.28	2.73
-7	9.05	2.32	9.05	2.42	8.93	2.53	8.88	2.63	8.83	2.75
-6	9.28	2.34	9.28	2.43	9.15	2.55	9.13	2.65	9.10	2.77
-5	9.50	2.36	9.50	2.45	9.38	2.56	9.38	2.67	9.38	2.79
-3	10.05	2.37	10.00	2.47	9.93	2.58	9.93	2.69	9.88	2.81
-1	10.60	2.39	10.50	2.49	10.48	2.60	10.48	2.71	10.38	2.83
0	10.88	2.41	10.75	2.51	10.75	2.62	10.75	2.73	10.63	2.85
1	11.18	2.43	11.05	2.53	11.05	2.64	11.05	2.75	10.93	2.87
3	11.78	2.45	11.65	2.55	11.65	2.66	11.65	2.77	11.53	2.89
5	12.38	2.47	12.25	2.57	12.25	2.68	12.25	2.79	12.13	2.90
6	12.63	2.49	12.50	2.59	12.50	2.70	12.50	2.80	12.38	2.92
7	12.91	2.51	12.81	2.60	12.78	2.72	12.78	2.82	12.66	2.94
9	13.47	2.53	13.44	2.62	13.34	2.73	13.34	2.84	13.22	2.96
10	13.75	2.54	13.75	2.64	13.63	2.75	13.63	2.86	13.50	2.98
11	13.88	2.56	13.83	2.66	13.73	2.77	13.68	2.88	13.58	3.00
14	14.25	2.58	14.05	2.68	14.03	2.79	13.83	2.90	13.80	3.02
15	14.38	2.60	14.13	2.70	14.13	2.81	13.88	2.92	13.88	3.04

RAS-5FSVN2E

To	Total power of combined indoor units (50%)										Total power of combined indoor units (60%)									
	Ti										Ti									
	16		18		20		22		24		16		18		20		22		24	
	CAP	IPT	CAP	IPT	CAP	IPT	CAP	IPT	CAP	IPT	CAP	IPT	CAP	IPT	CAP	IPT	CAP	IPT	CAP	IPT
-20	4.72	1.63	4.56	1.71	4.56	1.79	4.48	1.87	4.40	1.96	5.66	1.94	5.47	2.03	5.47	2.13	5.38	2.22	5.28	2.33
-17	4.86	1.65	4.75	1.72	4.70	1.80	4.62	1.89	4.59	1.97	5.84	1.96	5.70	2.04	5.64	2.14	5.55	2.24	5.51	2.34
-15	4.96	1.66	4.88	1.73	4.80	1.82	4.72	1.90	4.72	1.99	5.95	1.97	5.86	2.06	5.76	2.16	5.66	2.26	5.66	2.36
-13	5.15	1.68	5.07	1.75	4.99	1.83	4.91	1.91	4.91	2.00	6.18	1.99	6.09	2.08	5.99	2.18	5.89	2.27	5.89	2.38
-11	5.34	1.69	5.26	1.76	5.18	1.85	5.10	1.93	5.10	2.02	6.41	2.01	6.32	2.09	6.22	2.19	6.12	2.29	6.12	2.39
-10	5.44	1.70	5.36	1.78	5.28	1.86	5.20	1.94	5.20	2.03	6.53	2.02	6.43	2.11	6.34	2.21	6.24	2.31	6.24	2.41
-9	5.57	1.72	5.49	1.79	5.42	1.87	5.36	1.96	5.36	2.04	6.68	2.04	6.59	2.13	6.51	2.23	6.43	2.32	6.43	2.43
-7	5.82	1.73	5.74	1.81	5.71	1.89	5.68	1.97	5.68	2.06	6.99	2.06	6.89	2.14	6.85	2.24	6.82	2.34	6.82	2.44
-6	5.95	1.75	5.87	1.82	5.86	1.90	5.84	1.98	5.84	2.07	7.14	2.07	7.05	2.16	7.03	2.26	7.01	2.36	7.01	2.46
-5	6.08	1.76	6.00	1.83	6.00	1.92	6.00	2.00	6.00	2.09	7.30	2.09	7.20	2.18	7.20	2.28	7.20	2.37	7.20	2.48
-3	6.43	1.78	6.38	1.85	6.35	1.93	6.35	2.01	6.32	2.10	7.72	2.11	7.66	2.19	7.62	2.29	7.62	2.39	7.58	2.49
-1	6.78	1.79	6.77	1.86	6.70	1.95	6.70	2.03	6.64	2.12	8.14	2.12	8.12	2.21	8.04	2.31	8.04	2.41	7.97	2.51
0	6.96	1.80	6.96	1.88	6.88	1.96	6.88	2.04	6.80	2.13	8.35	2.14	8.35	2.23	8.26	2.33	8.26	2.42	8.16	2.53
1	7.15	1.82	7.15	1.89	7.07	1.97	7.06	2.05	6.98	2.14	8.58	2.16	8.58	2.24	8.49	2.34	8.47	2.44	8.37	2.55
3	7.54	1.83	7.54	1.90	7.46	1.99	7.41	2.07	7.33	2.16	9.04	2.18	9.04	2.26	8.95	2.36	8.89	2.46	8.79	2.56
5	7.92	1.85	7.92	1.92	7.84	2.00	7.76	2.08	7.68	2.17	9.50	2.19	9.50	2.28	9.41	2.38	9.31	2.47	9.22	2.58
6	8.16	1.86	8.08	1.93	8.00	2.02	7.92	2.10	7.84	2.19	9.79	2.21	9.70	2.29	9.60	2.39	9.50	2.49	9.41	2.60
7	8.34	1.87	8.24	1.95	8.18	2.03	8.10	2.11	8.00	2.20	10.01	2.23	9.89	2.31	9.82	2.41	9.72	2.51	9.60	2.61
9	8.70	1.89	8.56	1.96	8.54	2.04	8.46	2.12	8.32	2.21	10.44	2.24	10.27	2.33	10.25	2.43	10.15	2.52	9.98	2.63
10	8.88	1.90	8.72	1.97	8.72	2.06	8.64	2.14	8.48	2.23	10.66	2.26	10.46	2.35	10.46	2.44	10.37	2.54	10.18	2.65
11	8.94	1.92	8.78	1.99	8.77	2.07	8.69	2.15	8.53	2.24	10.73	2.28	10.54	2.36	10.52	2.46	10.43	2.56	10.23	2.66
14	9.14	1.93	8.98	2.00	8.91	2.09	8.83	2.17	8.67	2.26	10.96	2.29	10.77	2.38	10.69	2.48	10.60	2.57	10.41	2.68
15	9.20	1.94	9.04	2.02	8.96	2.10	8.88	2.18	8.72	2.27	11.04	2.31	10.85	2.40	10.75	2.49	10.66	2.59	10.46	2.70

To	Total power of combined indoor units (70%)										Total power of combined indoor units (80%)									
	Ti										Ti									
	16		18		20		22		24		16		18		20		22		24	
	CAP	IPT	CAP	IPT	CAP	IPT	CAP	IPT	CAP	IPT	CAP	IPT	CAP	IPT	CAP	IPT	CAP	IPT	CAP	IPT
-20	6.61	2.25	6.38	2.35	6.38	2.46	6.27	2.57	6.16	2.69	7.55	2.62	7.30	2.74	7.30	2.87	7.17	3.00	7.04	3.14
-17	6.81	2.27	6.65	2.37	6.59	2.48	6.47	2.59	6.43	2.71	7.78	2.64	7.60	2.76	7.53	2.89	7.40	3.02	7.35	3.17
-15	6.94	2.29	6.83	2.39	6.72	2.50	6.61	2.61	6.61	2.73	7.94	2.67	7.81	2.78	7.68	2.92	7.55	3.05	7.55	3.19
-13	7.21	2.31	7.10	2.40	6.99	2.52	6.88	2.63	6.88	2.75	8.24	2.69	8.12	2.81	7.99	2.94	7.86	3.07	7.86	3.21
-11	7.48	2.32	7.37	2.42	7.26	2.54	7.15	2.65	7.15	2.77	8.55	2.71	8.42	2.83	8.29	2.96	8.17	3.09	8.17	3.23
-10	7.62	2.34	7.50	2.44	7.39	2.56	7.28	2.67	7.28	2.79	8.70	2.73	8.58	2.85	8.45	2.98	8.32	3.11	8.32	3.26
-9	7.80	2.36	7.68	2.46	7.59	2.58	7.50	2.69	7.50	2.81	8.91	2.76	8.78	2.87	8.68	3.01	8.58	3.14	8.58	3.28
-7	8.15	2.38	8.04	2.48	8.00	2.60	7.95	2.71	7.95	2.83	9.32	2.78	9.19	2.90	9.14	3.03	9.09	3.16	9.09	3.30
-6	8.33	2.40	8.22	2.50	8.20	2.62	8.18	2.73	8.18	2.85	9.52	2.80	9.40	2.92	9.37	3.05	9.34	3.18	9.34	3.32
-5	8.51	2.42	8.40	2.52	8.40	2.64	8.40	2.75	8.40	2.87	9.73	2.83	9.60	2.94	9.60	3.08	9.60	3.21	9.60	3.35
-3	9.00	2.44	8.94	2.54	8.89	2.66	8.89	2.77	8.85	2.89	10.29	2.85	10.21	2.96	10.16	3.10	10.16	3.23	10.11	3.37
-1	9.50	2.46	9.48	2.56	9.39	2.67	9.39	2.79	9.30	2.91	10.85	2.87	10.83	2.99	10.73	3.12	10.73	3.25	10.62	3.39
0	9.74	2.48	9.74	2.58	9.63	2.69	9.63	2.81	9.52	2.93	11.14	2.89	11.14	3.01	11.01	3.14	11.01	3.27	10.88	3.42
1	10.01	2.50	10.01	2.60	9.90	2.71	9.88	2.82	9.77	2.95	11.44	2.92	11.44	3.03	11.32	3.17	11.29	3.30	11.16	3.44
3	10.55	2.52	10.55	2.62	10.44	2.73	10.37	2.84	10.26	2.97	12.06	2.94	12.06	3.05	11.93	3.19	11.85	3.32	11.72	3.46
5	11.09	2.54	11.09	2.64	10.98	2.75	10.86	2.86	10.75	2.99	12.67	2.96	12.67	3.08	12.54	3.21	12.42	3.34	12.29	3.48
6	11.42	2.56	11.31	2.66	11.20	2.77	11.09	2.88	10.98	3.01	13.06	2.98	12.93	3.10	12.80	3.23	12.67	3.36	12.54	3.51
7	11.68	2.58	11.54	2.68	11.45	2.79	11.34	2.90	11.20	3.02	13.34	3.01	13.18	3.12	13.09	3.26	12.96	3.39	12.80	3.53
9	12.18	2.60	11.98	2.70	11.96	2.81	11.84	2.92	11.65	3.04	13.92	3.03	13.70	3.15	13.66	3.28	13.54	3.41	13.31	3.55
10	12.43	2.62	12.21	2.72	12.21	2.83	12.10	2.94	11.87	3.06	14.21	3.05	13.95	3.17	13.95	3.30	13.82	3.43	13.57	3.57
11	12.52	2.63	12.30	2.73	12.28	2.85	12.16	2.96	11.94	3.08	14.31	3.07	14.05	3.19	14.03	3.32	13.90	3.45	13.64	3.60
14	12.79	2.65	12.57	2.75	12.48	2.87	12.36	2.98	12.14	3.10	14.62	3.10	14.36	3.21	14.26	3.35	14.13	3.48	13.88	3.62
15	12.88	2.67	12.66	2.77	12.54	2.89	12.43	3.00	12.21	3.12	14.72	3.12	14.46	3.24	14.34	3.37	14.21	3.50	13.95	3.64



To	Total power of combined indoor units (90%)										Total power of combined indoor units (100%)									
	Ti										Ti									
	16		18		20		22		24		16		18		20		22		24	
	CAP	IPT	CAP	IPT	CAP	IPT	CAP	IPT	CAP	IPT	CAP	IPT	CAP	IPT	CAP	IPT	CAP	IPT	CAP	IPT
-20	8.50	3.00	8.21	3.13	8.21	3.28	8.06	3.43	7.92	3.59	9.44	3.40	9.12	3.56	9.12	3.73	8.96	3.90	8.80	4.08
-17	8.76	3.02	8.55	3.15	8.47	3.31	8.32	3.46	8.27	3.62	9.73	3.43	9.50	3.59	9.41	3.76	9.25	3.93	9.18	4.11
-15	8.93	3.05	8.78	3.18	8.64	3.33	8.50	3.48	8.50	3.64	9.92	3.46	9.76	3.61	9.60	3.79	9.44	3.96	9.44	4.14
-13	9.27	3.07	9.13	3.21	8.99	3.36	8.84	3.51	8.84	3.67	10.30	3.49	10.14	3.64	9.98	3.82	9.82	3.99	9.82	4.17
-11	9.62	3.10	9.48	3.23	9.33	3.39	9.19	3.53	9.19	3.70	10.69	3.52	10.53	3.67	10.37	3.85	10.21	4.02	10.21	4.20
-10	9.79	3.13	9.65	3.26	9.50	3.41	9.36	3.56	9.36	3.72	10.88	3.55	10.72	3.70	10.56	3.88	10.40	4.04	10.40	4.23
-9	10.02	3.15	9.88	3.28	9.76	3.44	9.65	3.59	9.65	3.75	11.14	3.58	10.98	3.73	10.85	3.91	10.72	4.07	10.72	4.26
-7	10.48	3.18	10.34	3.31	10.28	3.46	10.22	3.61	10.22	3.77	11.65	3.61	11.49	3.76	11.42	3.94	11.36	4.10	11.36	4.29
-6	10.71	3.20	10.57	3.34	10.54	3.49	10.51	3.64	10.51	3.80	11.90	3.64	11.74	3.79	11.71	3.96	11.68	4.13	11.68	4.32
-5	10.94	3.23	10.80	3.36	10.80	3.51	10.80	3.66	10.80	3.83	12.16	3.67	12.00	3.82	12.00	3.99	12.00	4.16	12.00	4.35
-3	11.58	3.25	11.49	3.39	11.43	3.54	11.43	3.69	11.38	3.85	12.86	3.70	12.77	3.85	12.70	4.02	12.70	4.19	12.64	4.38
-1	12.21	3.28	12.18	3.41	12.07	3.57	12.07	3.71	11.95	3.88	13.57	3.73	13.54	3.88	13.41	4.05	13.41	4.22	13.28	4.41
0	12.53	3.31	12.53	3.44	12.38	3.59	12.38	3.74	12.24	3.90	13.92	3.76	13.92	3.91	13.76	4.08	13.76	4.25	13.60	4.44
1	12.87	3.33	12.87	3.47	12.73	3.62	12.70	3.77	12.56	3.93	14.30	3.79	14.30	3.94	14.14	4.11	14.11	4.28	13.95	4.47
3	13.56	3.36	13.56	3.49	13.42	3.64	13.33	3.79	13.19	3.96	15.07	3.82	15.07	3.97	14.91	4.14	14.82	4.31	14.66	4.49
5	14.26	3.38	14.26	3.52	14.11	3.67	13.97	3.82	13.82	3.98	15.84	3.85	15.84	4.00	15.68	4.17	15.52	4.34	15.36	4.52
6	14.69	3.41	14.54	3.54	14.40	3.70	14.26	3.84	14.11	4.01	16.32	3.87	16.16	4.03	16.00	4.20	15.84	4.37	15.68	4.55
7	15.01	3.44	14.83	3.57	14.72	3.72	14.58	3.87	14.40	4.03	16.68	3.90	16.48	4.06	16.36	4.23	16.20	4.40	16.00	4.58
9	15.66	3.46	15.41	3.59	15.37	3.75	15.23	3.90	14.98	4.06	17.40	3.93	17.12	4.08	17.08	4.26	16.92	4.43	16.64	4.61
10	15.98	3.49	15.70	3.62	15.70	3.77	15.55	3.92	15.26	4.08	17.76	3.96	17.44	4.11	17.44	4.29	17.28	4.46	16.96	4.64
11	16.10	3.51	15.81	3.65	15.78	3.80	15.64	3.95	15.35	4.11	17.89	3.99	17.57	4.14	17.54	4.32	17.38	4.49	17.06	4.67
14	16.44	3.54	16.16	3.67	16.04	3.83	15.90	3.97	15.61	4.14	18.27	4.02	17.95	4.17	17.82	4.35	17.66	4.52	17.34	4.70
15	16.56	3.56	16.27	3.70	16.13	3.85	15.98	4.00	15.70	4.16	18.40	4.05	18.08	4.20	17.92	4.38	17.76	4.54	17.44	4.73

To	Total power of combined indoor units (110%)										Total power of combined indoor units (120%)									
	Ti										Ti									
	16		18		20		22		24		16		18		20		22		24	
	CAP	IPT	CAP	IPT	CAP	IPT	CAP	IPT	CAP	IPT	CAP	IPT	CAP	IPT	CAP	IPT	CAP	IPT	CAP	IPT
-20	9.44	3.27	9.12	3.41	9.12	3.58	8.96	3.74	8.80	3.92	9.44	3.17	9.12	3.31	9.12	3.47	8.96	3.63	8.80	3.80
-17	9.73	3.30	9.50	3.44	9.41	3.61	9.25	3.77	9.18	3.95	9.73	3.19	9.50	3.33	9.41	3.50	9.25	3.65	9.18	3.82
-15	9.92	3.32	9.76	3.47	9.60	3.64	9.44	3.80	9.44	3.98	9.92	3.22	9.76	3.36	9.60	3.52	9.44	3.68	9.44	3.85
-13	10.30	3.35	10.14	3.50	9.98	3.67	9.82	3.83	9.82	4.00	10.30	3.25	10.14	3.39	9.98	3.55	9.82	3.71	9.82	3.88
-11	10.69	3.38	10.53	3.53	10.37	3.69	10.21	3.85	10.21	4.03	10.69	3.28	10.53	3.42	10.37	3.58	10.21	3.73	10.21	3.91
-10	10.88	3.41	10.72	3.55	10.56	3.72	10.40	3.88	10.40	4.06	10.88	3.30	10.72	3.44	10.56	3.61	10.40	3.76	10.40	3.93
-9	11.14	3.44	10.98	3.58	10.85	3.75	10.72	3.91	10.72	4.09	11.14	3.33	10.98	3.47	10.85	3.63	10.72	3.79	10.72	3.96
-7	11.65	3.47	11.49	3.61	11.42	3.78	11.36	3.94	11.36	4.12	11.65	3.36	11.49	3.50	11.42	3.66	11.36	3.82	11.36	3.99
-6	11.90	3.49	11.74	3.64	11.71	3.81	11.68	3.97	11.68	4.15	11.90	3.38	11.74	3.53	11.71	3.69	11.68	3.84	11.68	4.02
-5	12.16	3.52	12.00	3.67	12.00	3.83	12.00	4.00	12.00	4.17	12.16	3.41	12.00	3.55	12.00	3.71	12.00	3.87	12.00	4.04
-3	12.86	3.55	12.77	3.70	12.70	3.86	12.70	4.02	12.64	4.20	12.86	3.44	12.77	3.58	12.70	3.74	12.70	3.90	12.64	4.07
-1	13.57	3.58	13.54	3.72	13.41	3.89	13.41	4.05	13.28	4.23	13.57	3.47	13.54	3.61	13.41	3.77	13.41	3.93	13.28	4.10
0	13.92	3.61	13.92	3.75	13.76	3.92	13.76	4.08	13.60	4.26	13.92	3.49	13.92	3.63	13.76	3.80	13.76	3.95	13.60	4.13
1	14.30	3.64	14.30	3.78	14.14	3.95	14.11	4.11	13.95	4.29	14.30	3.52	14.30	3.66	14.14	3.82	14.11	3.98	13.95	4.15
3	15.07	3.66	15.07	3.81	14.91	3.98	14.82	4.14	14.66	4.31	15.07	3.55	15.07	3.69	14.91	3.85	14.82	4.01	14.66	4.18
5	15.84	3.69	15.84	3.84	15.68	4.00	15.52	4.17	15.36	4.34	15.84	3.58	15.84	3.72	15.68	3.88	15.52	4.04	15.36	4.21
6	16.32	3.72	16.16	3.87	16.00	4.03	15.84	4.19	15.68	4.37	16.32	3.60	16.16	3.74	16.00	3.91	15.84	4.06	15.68	4.23
7	16.68	3.75	16.48	3.89	16.36	4.06	16.20	4.22	16.00	4.40	16.68	3.63	16.48	3.77	16.36	3.93	16.20	4.09	16.00	4.26
9	17.40	3.78	17.12	3.92	17.08	4.09	16.92	4.25	16.64	4.43	17.40	3.66	17.12	3.80	17.08	3.96	16.92	4.12	16.64	4.29
10	17.76	3.80	17.44	3.95	17.44	4.12	17.28	4.28	16.96	4.46	17.76	3.69	17.44	3.83	17.44	3.99	17.28	4.14	16.96	4.32
11	17.89	3.83	17.57	3.98	17.54	4.14	17.38	4.31	17.06	4.48	17.89	3.71	17.57	3.85	17.54	4.02	17.38	4.17	17.06	4.34
14	18.27	3.86	17.95	4.01	17.82	4.17	17.66	4.33	17.34	4.51	18.27	3.74	17.95	3.88	17.82	4.04	17.66	4.20	17.34	4.37
15	18.40	3.89	18.08	4.03	17.92	4.20	17.76	4.36	17.44	4.54	18.40	3.77	18.08	3.91	17.92	4.07	17.76	4.23	17.44	4.40

To	Total power of combined indoor units (130%)									
	Ti									
	16		18		20		22		24	
	CAP	IPT	CAP	IPT	CAP	IPT	CAP	IPT	CAP	IPT
-20	9.44	3.03	9.12	3.16	9.12	3.32	8.96	3.47	8.80	3.63
-17	9.73	3.06	9.50	3.19	9.41	3.35	9.25	3.50	9.18	3.66
-15	9.92	3.08	9.76	3.22	9.60	3.37	9.44	3.52	9.44	3.69
-13	10.30	3.11	10.14	3.24	9.98	3.40	9.82	3.55	9.82	3.71
-11	10.69	3.13	10.53	3.27	10.37	3.42	10.21	3.57	10.21	3.74
-10	10.88	3.16	10.72	3.30	10.56	3.45	10.40	3.60	10.40	3.76
-9	11.14	3.19	10.98	3.32	10.85	3.48	10.72	3.63	10.72	3.79
-7	11.65	3.21	11.49	3.35	11.42	3.50	11.36	3.65	11.36	3.82
-6	11.90	3.24	11.74	3.37	11.71	3.53	11.68	3.68	11.68	3.84
-5	12.16	3.27	12.00	3.40	12.00	3.55	12.00	3.70	12.00	3.87
-3	12.86	3.29	12.77	3.43	12.70	3.58	12.70	3.73	12.64	3.90
-1	13.57	3.32	13.54	3.45	13.41	3.61	13.41	3.76	13.28	3.92
0	13.92	3.34	13.92	3.48	13.76	3.63	13.76	3.78	13.60	3.95
1	14.30	3.37	14.30	3.50	14.14	3.66	14.11	3.81	13.95	3.97
3	15.07	3.40	15.07	3.53	14.91	3.69	14.82	3.84	14.66	4.00
5	15.84	3.42	15.84	3.56	15.68	3.71	15.52	3.86	15.36	4.03
6	16.32	3.45	16.16	3.58	16.00	3.74	15.84	3.89	15.68	4.05
7	16.68	3.47	16.48	3.61	16.36	3.76	16.20	3.91	16.00	4.08
9	17.40	3.50	17.12	3.64	17.08	3.79	16.92	3.94	16.64	4.10
10	17.76	3.53	17.44	3.66	17.44	3.82	17.28	3.97	16.96	4.13
11	17.89	3.55	17.57	3.69	17.54	3.84	17.38	3.99	17.06	4.16
14	18.27	3.58	17.95	3.71	17.82	3.87	17.66	4.02	17.34	4.18
15	18.40	3.61	18.08	3.74	17.92	3.89	17.76	4.04	17.44	4.21

RAS-6FSVN2E

To	Total power of combined indoor units (50%)										Total power of combined indoor units (60%)									
	Ti										Ti									
	16		18		20		22		24		16		18		20		22		24	
	CAP	IPT	CAP	IPT	CAP	IPT	CAP	IPT	CAP	IPT	CAP	IPT	CAP	IPT	CAP	IPT	CAP	IPT	CAP	IPT
-20	5.13	1.91	4.95	1.99	4.95	2.09	4.86	2.18	4.86	2.29	6.16	2.26	5.94	2.36	5.94	2.48	5.83	2.59	5.83	2.72
-17	5.40	1.92	5.27	2.01	5.22	2.11	5.13	2.20	5.13	2.30	6.48	2.28	6.33	2.38	6.26	2.50	6.16	2.61	6.16	2.73
-15	5.58	1.94	5.49	2.02	5.40	2.12	5.31	2.22	5.31	2.32	6.70	2.30	6.59	2.40	6.48	2.52	6.37	2.63	6.37	2.75
-13	5.83	1.96	5.74	2.04	5.62	2.14	5.53	2.23	5.53	2.34	7.00	2.32	6.89	2.42	6.74	2.54	6.63	2.65	6.63	2.77
-11	6.08	1.97	5.99	2.06	5.83	2.15	5.74	2.25	5.74	2.35	7.30	2.34	7.19	2.44	7.00	2.56	6.89	2.67	6.89	2.79
-10	6.21	1.99	6.12	2.07	5.94	2.17	5.85	2.27	5.85	2.37	7.45	2.36	7.34	2.46	7.13	2.58	7.02	2.69	7.02	2.81
-9	6.32	2.01	6.25	2.09	6.10	2.19	6.03	2.28	6.03	2.39	7.58	2.38	7.50	2.48	7.32	2.60	7.24	2.71	7.24	2.83
-7	6.53	2.02	6.50	2.11	6.43	2.20	6.39	2.30	6.39	2.40	7.84	2.40	7.80	2.50	7.71	2.62	7.67	2.73	7.67	2.85
-6	6.64	2.04	6.62	2.12	6.59	2.22	6.57	2.31	6.57	2.42	7.97	2.42	7.95	2.52	7.91	2.64	7.88	2.75	7.88	2.87
-5	6.75	2.05	6.75	2.14	6.75	2.24	6.75	2.33	6.75	2.43	8.10	2.44	8.10	2.54	8.10	2.66	8.10	2.77	8.10	2.89
-3	7.18	2.07	7.18	2.16	7.15	2.25	7.15	2.35	7.11	2.45	8.62	2.46	8.62	2.56	8.58	2.68	8.58	2.79	8.53	2.91
-1	7.61	2.09	7.61	2.17	7.54	2.27	7.54	2.36	7.47	2.47	9.14	2.48	9.14	2.58	9.05	2.70	9.05	2.81	8.96	2.93
0	7.83	2.10	7.83	2.19	7.74	2.29	7.74	2.38	7.65	2.48	9.40	2.50	9.40	2.60	9.29	2.71	9.29	2.83	9.18	2.95
1	8.05	2.12	8.05	2.21	7.96	2.30	7.94	2.40	7.85	2.50	9.66	2.52	9.66	2.62	9.55	2.73	9.53	2.85	9.42	2.97
3	8.48	2.14	8.48	2.22	8.39	2.32	8.33	2.41	8.24	2.52	10.17	2.54	10.17	2.64	10.07	2.75	10.00	2.87	9.89	2.99
5	8.91	2.15	8.91	2.24	8.82	2.34	8.73	2.43	8.64	2.53	10.69	2.56	10.69	2.66	10.58	2.77	10.48	2.89	10.37	3.01
6	9.09	2.17	9.09	2.25	9.00	2.35	8.91	2.45	8.82	2.55	10.91	2.58	10.91	2.68	10.80	2.79	10.69	2.90	10.58	3.03
7	9.29	2.19	9.27	2.27	9.20	2.37	9.09	2.46	9.00	2.57	11.15	2.60	11.12	2.70	11.04	2.81	10.91	2.92	10.80	3.05
9	9.70	2.20	9.63	2.29	9.61	2.38	9.45	2.48	9.36	2.58	11.64	2.62	11.56	2.72	11.53	2.83	11.34	2.94	11.23	3.07
10	9.90	2.22	9.81	2.30	9.81	2.40	9.63	2.50	9.54	2.60	11.88	2.64	11.77	2.74	11.77	2.85	11.56	2.96	11.45	3.09
11	9.97	2.24	9.90	2.32	9.90	2.42	9.74	2.51	9.65	2.62	11.97	2.65	11.88	2.76	11.88	2.87	11.69	2.98	11.58	3.11
14	10.19	2.25	10.17	2.34	10.17	2.43	10.06	2.53	9.97	2.63	12.23	2.67	12.20	2.78	12.20	2.89	12.07	3.00	11.97	3.13
15	10.26	2.27	10.26	2.35	10.26	2.45	10.17	2.55	10.08	2.65	12.31	2.69	12.31	2.79	12.31	2.91	12.20	3.02	12.10	3.15



To	Total power of combined indoor units (70%)										Total power of combined indoor units (80%)									
	Ti										Ti									
	16		18		20		22		24		16		18		20		22		24	
	CAP	IPT	CAP	IPT	CAP	IPT	CAP	IPT	CAP	IPT	CAP	IPT	CAP	IPT	CAP	IPT	CAP	IPT	CAP	IPT
-20	7.18	2.62	6.93	2.74	6.93	2.87	6.80	3.00	6.80	3.14	8.21	3.06	7.92	3.19	7.92	3.35	7.78	3.50	7.78	3.67
-17	7.56	2.64	7.38	2.76	7.31	2.89	7.18	3.02	7.18	3.17	8.64	3.08	8.44	3.22	8.35	3.38	8.21	3.53	8.21	3.69
-15	7.81	2.67	7.69	2.78	7.56	2.92	7.43	3.05	7.43	3.19	8.93	3.11	8.78	3.25	8.64	3.40	8.50	3.55	8.50	3.72
-13	8.16	2.69	8.04	2.81	7.86	2.94	7.74	3.07	7.74	3.21	9.33	3.14	9.19	3.27	8.99	3.43	8.84	3.58	8.84	3.75
-11	8.52	2.71	8.39	2.83	8.16	2.96	8.04	3.09	8.04	3.23	9.73	3.16	9.59	3.30	9.33	3.46	9.19	3.61	9.19	3.77
-10	8.69	2.73	8.57	2.85	8.32	2.98	8.19	3.11	8.19	3.26	9.94	3.19	9.79	3.33	9.50	3.48	9.36	3.63	9.36	3.80
-9	8.85	2.76	8.74	2.87	8.54	3.01	8.44	3.14	8.44	3.28	10.11	3.22	9.99	3.35	9.76	3.51	9.65	3.66	9.65	3.83
-7	9.15	2.78	9.10	2.90	9.00	3.03	8.95	3.16	8.95	3.30	10.45	3.24	10.40	3.38	10.28	3.54	10.22	3.69	10.22	3.85
-6	9.30	2.80	9.27	2.92	9.22	3.05	9.20	3.18	9.20	3.32	10.63	3.27	10.60	3.41	10.54	3.56	10.51	3.71	10.51	3.88
-5	9.45	2.83	9.45	2.94	9.45	3.08	9.45	3.21	9.45	3.35	10.80	3.30	10.80	3.43	10.80	3.59	10.80	3.74	10.80	3.91
-3	10.05	2.85	10.05	2.96	10.00	3.10	10.00	3.23	9.95	3.37	11.49	3.32	11.49	3.46	11.43	3.61	11.43	3.77	11.38	3.93
-1	10.66	2.87	10.66	2.99	10.56	3.12	10.56	3.25	10.46	3.39	12.18	3.35	12.18	3.48	12.07	3.64	12.07	3.79	11.95	3.96
0	10.96	2.89	10.96	3.01	10.84	3.14	10.84	3.27	10.71	3.42	12.53	3.38	12.53	3.51	12.38	3.67	12.38	3.82	12.24	3.98
1	11.26	2.92	11.26	3.03	11.14	3.17	11.11	3.30	10.99	3.44	12.87	3.40	12.87	3.54	12.73	3.69	12.70	3.84	12.56	4.01
3	11.87	2.94	11.87	3.05	11.74	3.19	11.67	3.32	11.54	3.46	13.56	3.43	13.56	3.56	13.42	3.72	13.33	3.87	13.19	4.04
5	12.47	2.96	12.47	3.08	12.35	3.21	12.22	3.34	12.10	3.48	14.26	3.45	14.26	3.59	14.11	3.75	13.97	3.90	13.82	4.06
6	12.73	2.98	12.73	3.10	12.60	3.23	12.47	3.36	12.35	3.51	14.54	3.48	14.54	3.62	14.40	3.77	14.26	3.92	14.11	4.09
7	13.01	3.01	12.98	3.12	12.88	3.26	12.73	3.39	12.60	3.53	14.87	3.51	14.83	3.64	14.72	3.80	14.54	3.95	14.40	4.12
9	13.58	3.03	13.48	3.15	13.45	3.28	13.23	3.41	13.10	3.55	15.52	3.53	15.41	3.67	15.37	3.83	15.12	3.98	14.98	4.14
10	13.86	3.05	13.73	3.17	13.73	3.30	13.48	3.43	13.36	3.57	15.84	3.56	15.70	3.70	15.70	3.85	15.41	4.00	15.26	4.17
11	13.96	3.07	13.86	3.19	13.86	3.32	13.63	3.45	13.51	3.60	15.96	3.59	15.84	3.72	15.84	3.88	15.58	4.03	15.44	4.20
14	14.26	3.10	14.24	3.21	14.24	3.35	14.09	3.48	13.96	3.62	16.30	3.61	16.27	3.75	16.27	3.91	16.10	4.06	15.96	4.22
15	14.36	3.12	14.36	3.24	14.36	3.37	14.24	3.50	14.11	3.64	16.42	3.64	16.42	3.78	16.42	3.93	16.27	4.08	16.13	4.25

To	Total power of combined indoor units (90%)										Total power of combined indoor units (100%)									
	Ti										Ti									
	16		18		20		22		24		16		18		20		22		24	
	CAP	IPT	CAP	IPT	CAP	IPT	CAP	IPT	CAP	IPT	CAP	IPT	CAP	IPT	CAP	IPT	CAP	IPT	CAP	IPT
-20	9.23	3.50	8.91	3.65	8.91	3.83	8.75	4.00	8.75	4.19	10.26	3.97	9.90	4.15	9.90	4.35	9.72	4.55	9.72	4.76
-17	9.72	3.53	9.49	3.68	9.40	3.86	9.23	4.03	9.23	4.22	10.80	4.01	10.55	4.18	10.44	4.39	10.26	4.58	10.26	4.80
-15	10.04	3.56	9.88	3.71	9.72	3.89	9.56	4.06	9.56	4.25	11.16	4.04	10.98	4.22	10.80	4.42	10.62	4.62	10.62	4.83
-13	10.50	3.59	10.34	3.74	10.11	3.92	9.95	4.09	9.95	4.28	11.66	4.07	11.48	4.25	11.23	4.45	11.05	4.65	11.05	4.87
-11	10.95	3.62	10.79	3.77	10.50	3.95	10.34	4.12	10.34	4.31	12.17	4.11	11.99	4.29	11.66	4.49	11.48	4.68	11.48	4.90
-10	11.18	3.65	11.02	3.80	10.69	3.98	10.53	4.15	10.53	4.34	12.42	4.14	12.24	4.32	11.88	4.52	11.70	4.72	11.70	4.93
-9	11.37	3.68	11.24	3.83	10.98	4.01	10.85	4.18	10.85	4.37	12.64	4.18	12.49	4.35	12.20	4.56	12.06	4.75	12.06	4.97
-7	11.76	3.71	11.70	3.86	11.57	4.04	11.50	4.21	11.50	4.40	13.07	4.21	13.00	4.39	12.85	4.59	12.78	4.79	12.78	5.00
-6	11.96	3.74	11.92	3.89	11.86	4.07	11.83	4.24	11.83	4.43	13.28	4.25	13.25	4.42	13.18	4.63	13.14	4.82	13.14	5.04
-5	12.15	3.77	12.15	3.92	12.15	4.10	12.15	4.27	12.15	4.46	13.50	4.28	13.50	4.46	13.50	4.66	13.50	4.86	13.50	5.07
-3	12.93	3.80	12.93	3.95	12.86	4.13	12.86	4.30	12.80	4.49	14.36	4.31	14.36	4.49	14.29	4.69	14.29	4.89	14.22	5.11
-1	13.71	3.83	13.71	3.98	13.58	4.16	13.58	4.33	13.45	4.52	15.23	4.35	15.23	4.53	15.08	4.73	15.08	4.92	14.94	5.14
0	14.09	3.86	14.09	4.01	13.93	4.19	13.93	4.36	13.77	4.55	15.66	4.38	15.66	4.56	15.48	4.76	15.48	4.96	15.30	5.18
1	14.48	3.89	14.48	4.04	14.32	4.22	14.29	4.39	14.13	4.58	16.09	4.42	16.09	4.59	15.91	4.80	15.88	4.99	15.70	5.21
3	15.26	3.92	15.26	4.07	15.10	4.25	15.00	4.42	14.84	4.61	16.96	4.45	16.96	4.63	16.78	4.83	16.67	5.03	16.49	5.24
5	16.04	3.95	16.04	4.10	15.88	4.28	15.71	4.45	15.55	4.64	17.82	4.49	17.82	4.66	17.64	4.87	17.46	5.06	17.28	5.28
6	16.36	3.98	16.36	4.13	16.20	4.31	16.04	4.48	15.88	4.67	18.18	4.52	18.18	4.70	18.00	4.90	17.82	5.10	17.64	5.31
7	16.73	4.01	16.69	4.16	16.56	4.34	16.36	4.51	16.20	4.70	18.59	4.55	18.54	4.73	18.41	4.93	18.18	5.13	18.00	5.35
9	17.46	4.04	17.33	4.19	17.29	4.37	17.01	4.55	16.85	4.74	19.40	4.59	19.26	4.77	19.22	4.97	18.90	5.16	18.72	5.38
10	17.82	4.07	17.66	4.22	17.66	4.40	17.33	4.58	17.17	4.77	19.80	4.62	19.62	4.80	19.62	5.00	19.26	5.20	19.08	5.42
11	17.95	4.10	17.82	4.25	17.82	4.43	17.53	4.61	17.37	4.80	19.94	4.66	19.80	4.83	19.80	5.04	19.48	5.23	19.30	5.45
14	18.34	4.13	18.31	4.28	18.31	4.46	18.11	4.64	17.95	4.83	20.38	4.69	20.34	4.87	20.34	5.07	20.12	5.27	19.94	5.48
15	18.47	4.16	18.47	4.31	18.47	4.49	18.31	4.67	18.14	4.86	20.52	4.73	20.52	4.90	20.52	5.11	20.34	5.30	20.16	5.52

To	Total power of combined indoor units (110%)										Total power of combined indoor units (120%)									
	Ti										Ti									
	16		18		20		22		24		16		18		20		22		24	
	CAP	IPT	CAP	IPT	CAP	IPT	CAP	IPT	CAP	IPT	CAP	IPT	CAP	IPT	CAP	IPT	CAP	IPT	CAP	IPT
-20	10.26	3.81	9.90	3.98	9.90	4.18	9.72	4.37	9.72	4.57	10.26	3.69	9.90	3.86	9.90	4.05	9.72	4.23	9.72	4.43
-17	10.80	3.85	10.55	4.02	10.44	4.21	10.26	4.40	10.26	4.61	10.80	3.73	10.55	3.89	10.44	4.08	10.26	4.26	10.26	4.46
-15	11.16	3.88	10.98	4.05	10.80	4.24	10.62	4.43	10.62	4.64	11.16	3.76	10.98	3.92	10.80	4.11	10.62	4.29	10.62	4.49
-13	11.66	3.91	11.48	4.08	11.23	4.28	11.05	4.46	11.05	4.67	11.66	3.79	11.48	3.95	11.23	4.14	11.05	4.32	11.05	4.53
-11	12.17	3.94	11.99	4.11	11.66	4.31	11.48	4.50	11.48	4.70	12.17	3.82	11.99	3.99	11.66	4.17	11.48	4.36	11.48	4.56
-10	12.42	3.98	12.24	4.15	11.88	4.34	11.70	4.53	11.70	4.74	12.42	3.85	12.24	4.02	11.88	4.21	11.70	4.39	11.70	4.59
-9	12.64	4.01	12.49	4.18	12.20	4.37	12.06	4.56	12.06	4.77	12.64	3.89	12.49	4.05	12.20	4.24	12.06	4.42	12.06	4.62
-7	13.07	4.04	13.00	4.21	12.85	4.41	12.78	4.60	12.78	4.80	13.07	3.92	13.00	4.08	12.85	4.27	12.78	4.45	12.78	4.65
-6	13.28	4.08	13.25	4.28	13.18	4.44	13.14	4.63	13.14	4.84	13.28	3.95	13.25	4.11	13.18	4.30	13.14	4.48	13.14	4.69
-5	13.50	4.11	13.50	4.25	13.50	4.47	13.50	4.66	13.50	4.87	13.50	3.98	13.50	4.15	13.50	4.33	13.50	4.52	13.50	4.72
-3	14.36	4.14	14.36	4.31	14.29	4.51	14.29	4.69	14.22	4.90	14.36	4.01	14.36	4.18	14.29	4.37	14.29	4.55	14.22	4.75
-1	15.23	4.18	15.23	4.34	15.08	4.54	15.08	4.73	14.94	4.94	15.23	4.04	15.23	4.21	15.08	4.40	15.08	4.58	14.94	4.78
0	15.66	4.21	15.66	4.38	15.48	4.57	15.48	4.76	15.30	4.97	15.66	4.08	15.66	4.24	15.48	4.43	15.48	4.61	15.30	4.81
1	16.09	4.24	16.09	4.41	15.91	4.61	15.88	4.79	15.70	5.00	16.09	4.11	16.09	4.27	15.91	4.46	15.88	4.64	15.70	4.84
3	16.96	4.27	16.96	4.44	16.78	4.64	16.67	4.83	16.49	5.03	16.96	4.14	16.96	4.30	16.78	4.49	16.67	4.68	16.49	4.88
5	17.82	4.31	17.82	4.48	17.64	4.67	17.46	4.86	17.28	5.07	17.82	4.17	17.82	4.34	17.64	4.53	17.46	4.71	17.28	4.91
6	18.18	4.34	18.18	4.51	18.00	4.70	17.82	4.89	17.64	5.10	18.18	4.20	18.18	4.37	18.00	4.56	17.82	4.74	17.64	4.94
7	18.59	4.37	18.54	4.54	18.41	4.74	18.18	4.93	18.00	5.13	18.59	4.24	18.54	4.40	18.41	4.59	18.18	4.77	18.00	4.97
9	19.40	4.41	19.26	4.58	19.22	4.77	18.90	4.96	18.72	5.17	19.40	4.27	19.26	4.43	19.22	4.62	18.90	4.80	18.72	5.00
10	19.80	4.44	19.62	4.61	19.62	4.80	19.26	4.99	19.08	5.20	19.80	4.30	19.62	4.46	19.62	4.65	19.26	4.84	19.08	5.04
11	19.94	4.47	19.80	4.64	19.80	4.84	19.48	5.02	19.30	5.23	19.94	4.33	19.80	4.50	19.80	4.68	19.48	4.87	19.30	5.07
14	20.38	4.50	20.34	4.67	20.34	4.87	20.12	5.06	19.94	5.26	20.38	4.36	20.34	4.53	20.34	4.72	20.12	4.90	19.94	5.10
15	20.52	4.54	20.52	4.71	20.52	4.90	20.34	5.09	20.16	5.30	20.52	4.40	20.52	4.56	20.52	4.75	20.34	4.93	20.16	5.13

To	Total power of combined indoor units (130%)									
	Ti									
	16		18		20		22		24	
	CAP	IPT	CAP	IPT	CAP	IPT	CAP	IPT	CAP	IPT
-20	10.26	3.53	9.90	3.69	9.90	3.87	9.72	4.05	9.72	4.24
-17	10.80	3.57	10.55	3.72	10.44	3.90	10.26	4.08	10.26	4.27
-15	11.16	3.60	10.98	3.75	10.80	3.93	10.62	4.11	10.62	4.30
-13	11.66	3.63	11.48	3.78	11.23	3.96	11.05	4.14	11.05	4.33
-11	12.17	3.66	11.99	3.81	11.66	3.99	11.48	4.17	11.48	4.36
-10	12.42	3.69	12.24	3.84	11.88	4.03	11.70	4.20	11.70	4.39
-9	12.64	3.72	12.49	3.88	12.20	4.06	12.06	4.23	12.06	4.42
-7	13.07	3.75	13.00	3.91	12.85	4.09	12.78	4.26	12.78	4.45
-6	13.28	3.78	13.25	3.94	13.18	4.12	13.14	4.29	13.14	4.48
-5	13.50	3.81	13.50	3.97	13.50	4.15	13.50	4.32	13.50	4.51
-3	14.36	3.84	14.36	4.00	14.29	4.18	14.29	4.35	14.22	4.54
-1	15.23	3.87	15.23	4.03	15.08	4.21	15.08	4.38	14.94	4.58
0	15.66	3.90	15.66	4.06	15.48	4.24	15.48	4.41	15.30	4.61
1	16.09	3.93	16.09	4.09	15.91	4.27	15.88	4.44	15.70	4.64
3	16.96	3.96	16.96	4.12	16.78	4.30	16.67	4.47	16.49	4.67
5	17.82	3.99	17.82	4.15	17.64	4.33	17.46	4.51	17.28	4.70
6	18.18	4.02	18.18	4.18	18.00	4.36	17.82	4.54	17.64	4.73
7	18.59	4.05	18.54	4.21	18.41	4.39	18.18	4.57	18.00	4.76
9	19.40	4.08	19.26	4.24	19.22	4.42	18.90	4.60	18.72	4.79
10	19.80	4.11	19.62	4.27	19.62	4.45	19.26	4.63	19.08	4.82
11	19.94	4.15	19.80	4.30	19.80	4.48	19.48	4.66	19.30	4.85
14	20.38	4.18	20.34	4.33	20.34	4.51	20.12	4.69	19.94	4.88
15	20.52	4.21	20.52	4.36	20.52	4.54	20.34	4.72	20.16	4.91

4

◆ RAS-(4-6)FSNY2E

RAS-4FSNY2E

To	Total power of combined indoor units (50%)										Total power of combined indoor units (60%)									
	Ti										Ti									
	16		18		20		22		24		16		18		20		22		24	
	CAP	IPT	CAP	IPT	CAP	IPT	CAP	IPT	CAP	IPT	CAP	IPT	CAP	IPT	CAP	IPT	CAP	IPT	CAP	IPT
-20	3.69	1.17	3.56	1.22	3.50	1.28	3.44	1.34	3.38	1.40	4.43	1.39	4.28	1.45	4.20	1.52	4.13	1.59	4.05	1.66
-17	3.80	1.18	3.71	1.23	3.65	1.29	3.59	1.35	3.53	1.41	4.56	1.40	4.46	1.46	4.38	1.53	4.31	1.60	4.23	1.67
-15	3.88	1.19	3.81	1.24	3.75	1.30	3.69	1.36	3.63	1.42	4.65	1.41	4.58	1.47	4.50	1.54	4.43	1.61	4.35	1.69
-13	4.00	1.20	3.96	1.25	3.90	1.31	3.84	1.37	3.78	1.43	4.80	1.42	4.76	1.48	4.68	1.55	4.61	1.62	4.53	1.70
-11	4.13	1.21	4.11	1.26	4.05	1.32	3.99	1.38	3.93	1.44	4.95	1.43	4.94	1.50	4.86	1.57	4.79	1.63	4.71	1.71
-10	4.19	1.22	4.19	1.27	4.13	1.33	4.06	1.39	4.00	1.45	5.03	1.45	5.03	1.51	4.95	1.58	4.88	1.65	4.80	1.72
-9	4.30	1.23	4.30	1.28	4.24	1.34	4.19	1.40	4.14	1.46	5.16	1.46	5.16	1.52	5.09	1.59	5.03	1.66	4.97	1.73
-7	4.53	1.24	4.53	1.29	4.46	1.35	4.44	1.41	4.41	1.47	5.43	1.47	5.43	1.53	5.36	1.60	5.33	1.67	5.30	1.75
-6	4.64	1.25	4.64	1.30	4.58	1.36	4.56	1.42	4.55	1.48	5.57	1.48	5.57	1.54	5.49	1.61	5.48	1.68	5.46	1.76
-5	4.75	1.26	4.75	1.31	4.69	1.37	4.69	1.43	4.69	1.49	5.70	1.49	5.70	1.56	5.63	1.63	5.63	1.69	5.63	1.77
-3	5.03	1.27	5.00	1.32	4.96	1.38	4.96	1.44	4.94	1.50	6.03	1.51	6.00	1.57	5.96	1.64	5.96	1.71	5.93	1.78
-1	5.30	1.28	5.25	1.33	5.24	1.39	5.24	1.45	5.19	1.51	6.36	1.52	6.30	1.58	6.29	1.65	6.29	1.72	6.23	1.79
0	5.44	1.29	5.38	1.34	5.38	1.40	5.38	1.46	5.31	1.52	6.53	1.53	6.45	1.59	6.45	1.66	6.45	1.73	6.38	1.81
1	5.59	1.30	5.53	1.35	5.53	1.41	5.53	1.47	5.46	1.53	6.71	1.54	6.63	1.60	6.63	1.67	6.63	1.74	6.56	1.82
3	5.89	1.31	5.83	1.36	5.83	1.42	5.83	1.48	5.76	1.54	7.07	1.55	6.99	1.62	6.99	1.69	6.99	1.75	6.92	1.83
5	6.19	1.32	6.13	1.37	6.13	1.43	6.13	1.49	6.06	1.55	7.43	1.57	7.35	1.63	7.35	1.70	7.35	1.77	7.28	1.84
6	6.31	1.33	6.25	1.38	6.25	1.44	6.25	1.50	6.19	1.56	7.58	1.58	7.50	1.64	7.50	1.71	7.50	1.78	7.43	1.85
7	6.45	1.34	6.41	1.39	6.39	1.45	6.39	1.51	6.33	1.57	7.74	1.59	7.69	1.65	7.67	1.72	7.67	1.79	7.59	1.87
9	6.73	1.35	6.72	1.40	6.67	1.46	6.67	1.52	6.61	1.58	8.08	1.60	8.06	1.66	8.01	1.73	8.01	1.80	7.93	1.88
10	6.88	1.36	6.88	1.41	6.81	1.47	6.81	1.53	6.75	1.59	8.25	1.61	8.25	1.68	8.18	1.75	8.18	1.81	8.10	1.89
11	6.94	1.37	6.91	1.42	6.86	1.48	6.84	1.54	6.79	1.60	8.33	1.63	8.30	1.69	8.24	1.76	8.21	1.83	8.15	1.90
14	7.13	1.38	7.03	1.43	7.01	1.49	6.91	1.55	6.90	1.61	8.55	1.64	8.43	1.70	8.42	1.77	8.30	1.84	8.28	1.91
15	7.19	1.39	7.06	1.44	7.06	1.50	6.94	1.56	6.94	1.62	8.63	1.65	8.48	1.71	8.48	1.78	8.33	1.85	8.33	1.93

To	Total power of combined indoor units (70%)										Total power of combined indoor units (80%)									
	Ti										Ti									
	16		18		20		22		24		16		18		20		22		24	
	CAP	IPT	CAP	IPT	CAP	IPT	CAP	IPT	CAP	IPT	CAP	IPT	CAP	IPT	CAP	IPT	CAP	IPT	CAP	IPT
-20	5.16	1.60	4.99	1.68	4.90	1.76	4.81	1.84	4.73	1.92	5.90	1.87	5.70	1.96	5.60	2.05	5.50	2.14	5.40	2.25
-17	5.32	1.62	5.20	1.69	5.11	1.77	5.02	1.85	4.94	1.94	6.08	1.89	5.94	1.97	5.84	2.07	5.74	2.16	5.64	2.26
-15	5.43	1.63	5.34	1.70	5.25	1.79	5.16	1.87	5.08	1.95	6.20	1.90	6.10	1.99	6.00	2.08	5.90	2.18	5.80	2.28
-13	5.60	1.65	5.55	1.72	5.46	1.80	5.37	1.88	5.29	1.97	6.40	1.92	6.34	2.00	6.24	2.10	6.14	2.19	6.04	2.29
-11	5.78	1.66	5.76	1.73	5.67	1.81	5.58	1.89	5.50	1.98	6.60	1.94	6.58	2.02	6.48	2.12	6.38	2.21	6.28	2.31
-10	5.86	1.67	5.86	1.75	5.78	1.83	5.69	1.91	5.60	1.99	6.70	1.95	6.70	2.04	6.60	2.13	6.50	2.22	6.40	2.33
-9	6.02	1.69	6.02	1.76	5.93	1.84	5.86	1.92	5.79	2.01	6.88	1.97	6.88	2.05	6.78	2.15	6.70	2.24	6.62	2.34
-7	6.34	1.70	6.34	1.77	6.25	1.86	6.21	1.93	6.18	2.02	7.24	1.99	7.24	2.07	7.14	2.16	7.10	2.26	7.06	2.36
-6	6.49	1.72	6.49	1.79	6.41	1.87	6.39	1.95	6.37	2.04	7.42	2.00	7.42	2.09	7.32	2.18	7.30	2.27	7.28	2.37
-5	6.65	1.73	6.65	1.80	6.56	1.88	6.56	1.96	6.56	2.05	7.60	2.02	7.60	2.10	7.50	2.20	7.50	2.29	7.50	2.39
-3	7.04	1.74	7.00	1.81	6.95	1.90	6.95	1.98	6.91	2.06	8.04	2.03	8.00	2.12	7.94	2.21	7.94	2.31	7.90	2.41
-1	7.42	1.76	7.35	1.83	7.33	1.91	7.33	1.99	7.26	2.08	8.48	2.05	8.40	2.13	8.38	2.23	8.38	2.32	8.30	2.42
0	7.61	1.77	7.53	1.84	7.53	1.92	7.53	2.00	7.44	2.09	8.70	2.07	8.60	2.15	8.60	2.25	8.60	2.34	8.50	2.44
1	7.82	1.79	7.74	1.86	7.74	1.94	7.74	2.02	7.65	2.10	8.94	2.08	8.84	2.17	8.84	2.26	8.84	2.35	8.74	2.46
3	8.24	1.80	8.16	1.87	8.16	1.95	8.16	2.03	8.07	2.12	9.42	2.10	9.32	2.18	9.32	2.28	9.32	2.37	9.22	2.47
5	8.66	1.81	8.58	1.88	8.58	1.97	8.58	2.05	8.49	2.13	9.90	2.11	9.80	2.20	9.80	2.29	9.80	2.39	9.70	2.49
6	8.84	1.83	8.75	1.90	8.75	1.98	8.75	2.06	8.66	2.15	10.10	2.13	10.00	2.21	10.00	2.31	10.00	2.40	9.90	2.50
7	9.03	1.84	8.97	1.91	8.95	1.99	8.95	2.07	8.86	2.16	10.33	2.15	10.25	2.23	10.23	2.33	10.23	2.42	10.13	2.52
9	9.43	1.85	9.41	1.93	9.34	2.01	9.34	2.09	9.25	2.17	10.78	2.16	10.75	2.25	10.68	2.34	10.68	2.43	10.58	2.54
10	9.63	1.87	9.63	1.94	9.54	2.02	9.54	2.10	9.45	2.19	11.00	2.18	11.00	2.26	10.90	2.36	10.90	2.45	10.80	2.55
11	9.71	1.88	9.68	1.95	9.61	2.04	9.57	2.11	9.50	2.20	11.10	2.20	11.06	2.28	10.98	2.37	10.94	2.47	10.86	2.57
14	9.98	1.90	9.84	1.97	9.82	2.05	9.68	2.13	9.66	2.22	11.40	2.21	11.24	2.30	11.22	2.39	11.06	2.48	11.04	2.59
15	10.06	1.91	9.89	1.98	9.89	2.06	9.71	2.14	9.71	2.23	11.50	2.23	11.30	2.31	11.30	2.41	11.10	2.50	11.10	2.60

To	Total power of combined indoor units (90%)										Total power of combined indoor units (100%)									
	Ti										Ti									
	16		18		20		22		24		16		18		20		22		24	
	CAP	IPT	CAP	IPT	CAP	IPT	CAP	IPT	CAP	IPT	CAP	IPT	CAP	IPT	CAP	IPT	CAP	IPT	CAP	IPT
-20	6.64	2.14	6.41	2.24	6.30	2.34	6.19	2.45	6.08	2.57	7.38	2.43	7.13	2.54	7.00	2.66	6.88	2.78	6.75	2.92
-17	6.84	2.16	6.68	2.25	6.57	2.36	6.46	2.47	6.35	2.58	7.60	2.45	7.43	2.56	7.30	2.69	7.18	2.81	7.05	2.94
-15	6.98	2.18	6.86	2.27	6.75	2.38	6.64	2.49	6.53	2.60	7.75	2.47	7.63	2.58	7.50	2.71	7.38	2.83	7.25	2.96
-13	7.20	2.20	7.13	2.29	7.02	2.40	6.91	2.51	6.80	2.62	8.00	2.49	7.93	2.60	7.80	2.73	7.68	2.85	7.55	2.98
-11	7.43	2.21	7.40	2.31	7.29	2.42	7.18	2.52	7.07	2.64	8.25	2.52	8.23	2.62	8.10	2.75	7.98	2.87	7.85	3.00
-10	7.54	2.23	7.54	2.33	7.43	2.44	7.31	2.54	7.20	2.66	8.38	2.54	8.38	2.64	8.25	2.77	8.13	2.89	8.00	3.02
-9	7.74	2.25	7.74	2.35	7.63	2.46	7.54	2.56	7.45	2.68	8.60	2.56	8.60	2.67	8.48	2.79	8.38	2.91	8.28	3.04
-7	8.15	2.27	8.15	2.36	8.03	2.47	7.99	2.58	7.94	2.70	9.05	2.58	9.05	2.69	8.93	2.81	8.88	2.93	8.83	3.06
-6	8.35	2.29	8.35	2.38	8.24	2.49	8.21	2.60	8.19	2.71	9.28	2.60	9.28	2.71	9.15	2.83	9.13	2.95	9.10	3.08
-5	8.55	2.31	8.55	2.40	8.44	2.51	8.44	2.62	8.44	2.73	9.50	2.62	9.50	2.73	9.38	2.85	9.38	2.97	9.38	3.11
-3	9.05	2.32	9.00	2.42	8.93	2.53	8.93	2.63	8.89	2.75	10.05	2.64	10.00	2.75	9.93	2.87	9.93	2.99	9.88	3.13
-1	9.54	2.34	9.45	2.44	9.43	2.55	9.43	2.65	9.34	2.77	10.60	2.66	10.50	2.77	10.48	2.90	10.48	3.02	10.38	3.15
0	9.79	2.36	9.68	2.46	9.68	2.57	9.68	2.67	9.56	2.79	10.88	2.68	10.75	2.79	10.75	2.92	10.75	3.04	10.63	3.17
1	10.06	2.38	9.95	2.48	9.95	2.58	9.95	2.69	9.83	2.81	11.18	2.70	11.05	2.81	11.05	2.94	11.05	3.06	10.93	3.19
3	10.60	2.40	10.49	2.49	10.49	2.60	10.49	2.71	10.37	2.83	11.78	2.73	11.65	2.83	11.65	2.96	11.65	3.08	11.53	3.21
5	11.14	2.42	11.03	2.51	11.03	2.62	11.03	2.73	10.91	2.84	12.38	2.75	12.25	2.85	12.25	2.98	12.25	3.10	12.13	3.23
6	11.36	2.44	11.25	2.53	11.25	2.64	11.25	2.75	11.14	2.86	12.63	2.77	12.50	2.88	12.50	3.00	12.50	3.12	12.38	3.25
7	11.62	2.45	11.53	2.55	11.50	2.66	11.50	2.76	11.39	2.88	12.91	2.79	12.81	2.90	12.78	3.02	12.78	3.14	12.66	3.27
9	12.12	2.47	12.09	2.57	12.01	2.68	12.01	2.78	11.90	2.90	13.47	2.81	13.44	2.92	13.34	3.04	13.34	3.16	13.22	3.29
10	12.38	2.49	12.38	2.59	12.26	2.70	12.26	2.80	12.15	2.92	13.75	2.83	13.75	2.94	13.63	3.06	13.63	3.18	13.50	3.32
11	12.49	2.51	12.44	2.60	12.35	2.71	12.31	2.82	12.22	2.94	13.88	2.85	13.83	2.96	13.73	3.08	13.68	3.20	13.58	3.34
14	12.83	2.53	12.65	2.62	12.62	2.73	12.44	2.84	12.42	2.95	14.25	2.87	14.05	2.98	14.03	3.10	13.83	3.23	13.80	3.36
15	12.94	2.55	12.71	2.64	12.71	2.75	12.49	2.86	12.49	2.97	14.38	2.89	14.13	3.00	14.13	3.13	13.88	3.25	13.88	3.38

To	Total power of combined indoor units (110%)										Total power of combined indoor units (120%)									
	Ti										Ti									
	16		18		20		22		24		16		18		20		22		24	
	CAP	IPT	CAP	IPT	CAP	IPT	CAP	IPT	CAP	IPT	CAP	IPT	CAP	IPT	CAP	IPT	CAP	IPT	CAP	IPT
-20	7.38	2.33	7.13	2.44	7.00	2.56	6.88	2.67	6.75	2.80	7.38	2.26	7.13	2.36	7.00	2.48	6.88	2.59	6.75	2.71
-17	7.60	2.35	7.43	2.46	7.30	2.58	7.18	2.69	7.05	2.82	7.60	2.28	7.43	2.38	7.30	2.50	7.18	2.61	7.05	2.73
-15	7.75	2.37	7.63	2.48	7.50	2.60	7.38	2.71	7.25	2.84	7.75	2.30	7.63	2.40	7.50	2.52	7.38	2.63	7.25	2.75
-13	8.00	2.39	7.93	2.50	7.80	2.62	7.68	2.73	7.55	2.86	8.00	2.32	7.93	2.42	7.80	2.54	7.68	2.65	7.55	2.77
-11	8.25	2.42	8.23	2.52	8.10	2.64	7.98	2.75	7.85	2.88	8.25	2.34	8.23	2.44	8.10	2.56	7.98	2.67	7.85	2.79
-10	8.38	2.44	8.38	2.54	8.25	2.66	8.13	2.77	8.00	2.90	8.38	2.36	8.38	2.46	8.25	2.58	8.13	2.69	8.00	2.81
-9	8.60	2.46	8.60	2.56	8.48	2.68	8.38	2.79	8.28	2.92	8.60	2.38	8.60	2.48	8.48	2.59	8.38	2.71	8.28	2.83
-7	9.05	2.48	9.05	2.58	8.93	2.70	8.88	2.81	8.83	2.94	9.05	2.40	9.05	2.50	8.93	2.61	8.88	2.73	8.83	2.85
-6	9.28	2.50	9.28	2.60	9.15	2.72	9.13	2.83	9.10	2.96	9.28	2.42	9.28	2.52	9.15	2.63	9.13	2.75	9.10	2.87
-5	9.50	2.52	9.50	2.62	9.38	2.74	9.38	2.85	9.38	2.98	9.50	2.44	9.50	2.54	9.38	2.65	9.38	2.77	9.38	2.89
-3	10.05	2.54	10.00	2.64	9.93	2.76	9.93	2.87	9.88	3.00	10.05	2.46	10.00	2.56	9.93	2.67	9.93	2.78	9.88	2.91
-1	10.60	2.56	10.50	2.66	10.48	2.78	10.48	2.89	10.38	3.02	10.60	2.48	10.50	2.58	10.48	2.69	10.48	2.80	10.38	2.93
0	10.88	2.58	10.75	2.68	10.75	2.80	10.75	2.91	10.63	3.04	10.88	2.50	10.75	2.60	10.75	2.71	10.75	2.82	10.63	2.95
1	11.18	2.60	11.05	2.70	11.05	2.82	11.05	2.93	10.93	3.06	11.18	2.52	11.05	2.62	11.05	2.73	11.05	2.84	10.93	2.97
3	11.78	2.62	11.65	2.72	11.65	2.84	11.65	2.96	11.53	3.08	11.78	2.53	11.65	2.64	11.65	2.75	11.65	2.86	11.53	2.99
5	12.38	2.64	12.25	2.74	12.25	2.86	12.25	2.98	12.13	3.10	12.38	2.55	12.25	2.65	12.25	2.77	12.25	2.88	12.13	3.01
6	12.63	2.66	12.50	2.76	12.50	2.88	12.50	3.00	12.38	3.12	12.63	2.57	12.50	2.67	12.50	2.79	12.50	2.90	12.38	3.02
7	12.91	2.68	12.81	2.78	12.78	2.90	12.78	3.02	12.66	3.14	12.91	2.59	12.81	2.69	12.78	2.81	12.78	2.92	12.66	3.04
9	13.47	2.70	13.44	2.80	13.34	2.92	13.34	3.04	13.22	3.16	13.47	2.61	13.44	2.71	13.34	2.83	13.34	2.94	13.22	3.06
10	13.75	2.72	13.75	2.82	13.63	2.94	13.63	3.06	13.50	3.18	13.75	2.63	13.75	2.73	13.63	2.85	13.63	2.96	13.50	3.08
11	13.88	2.74	13.83	2.84	13.73	2.96	13.68	3.08	13.58	3.20	13.88	2.65	13.83	2.75	13.73	2.87	13.68	2.98	13.58	3.10
14	14.25	2.76	14.05	2.86	14.03	2.98	13.83	3.10	13.80	3.22	14.25	2.67	14.05	2.77	14.03	2.89	13.83	3.00	13.80	3.12
15	14.38	2.78	14.13	2.88	14.13	3.00	13.88	3.12	13.88	3.24	14.38	2.69	14.13	2.79	14.13	2.91	13.88	3.02	13.88	3.14

4

To	Total power of combined indoor units (130%)									
	Ti									
	16		18		20		22		24	
	CAP	IPT	CAP	IPT	CAP	IPT	CAP	IPT	CAP	IPT
-20	7.38	2.16	7.13	2.26	7.00	2.37	6.88	2.48	6.75	2.60
-17	7.60	2.18	7.43	2.28	7.30	2.39	7.18	2.50	7.05	2.61
-15	7.75	2.20	7.63	2.30	7.50	2.41	7.38	2.52	7.25	2.63
-13	8.00	2.22	7.93	2.32	7.80	2.43	7.68	2.53	7.55	2.65
-11	8.25	2.24	8.23	2.34	8.10	2.45	7.98	2.55	7.85	2.67
-10	8.38	2.26	8.38	2.35	8.25	2.46	8.13	2.57	8.00	2.69
-9	8.60	2.28	8.60	2.37	8.48	2.48	8.38	2.59	8.28	2.71
-7	9.05	2.29	9.05	2.39	8.93	2.50	8.88	2.61	8.83	2.73
-6	9.28	2.31	9.28	2.41	9.15	2.52	9.13	2.63	9.10	2.75
-5	9.50	2.33	9.50	2.43	9.38	2.54	9.38	2.65	9.38	2.76
-3	10.05	2.35	10.00	2.45	9.93	2.56	9.93	2.66	9.88	2.78
-1	10.60	2.37	10.50	2.47	10.48	2.58	10.48	2.68	10.38	2.80
0	10.88	2.39	10.75	2.48	10.75	2.60	10.75	2.70	10.63	2.82
1	11.18	2.41	11.05	2.50	11.05	2.61	11.05	2.72	10.93	2.84
3	11.78	2.43	11.65	2.52	11.65	2.63	11.65	2.74	11.53	2.86
5	12.38	2.44	12.25	2.54	12.25	2.65	12.25	2.76	12.13	2.88
6	12.63	2.46	12.50	2.56	12.50	2.67	12.50	2.78	12.38	2.89
7	12.91	2.48	12.81	2.58	12.78	2.69	12.78	2.80	12.66	2.91
9	13.47	2.50	13.44	2.60	13.34	2.71	13.34	2.81	13.22	2.93
10	13.75	2.52	13.75	2.62	13.63	2.73	13.63	2.83	13.50	2.95
11	13.88	2.54	13.83	2.63	13.73	2.74	13.68	2.85	13.58	2.97
14	14.25	2.56	14.05	2.65	14.03	2.76	13.83	2.87	13.80	2.99
15	14.38	2.58	14.13	2.67	14.13	2.78	13.88	2.89	13.88	3.01

RAS-5FSNY2E

To	Total power of combined indoor units (50%)										Total power of combined indoor units (60%)									
	Ti										Ti									
	16		18		20		22		24		16		18		20		22		24	
	CAP	IPT	CAP	IPT	CAP	IPT	CAP	IPT	CAP	IPT	CAP	IPT	CAP	IPT	CAP	IPT	CAP	IPT	CAP	IPT
-20	4.72	1.62	4.56	1.69	4.56	1.77	4.48	1.85	4.40	1.94	5.66	1.92	5.47	2.01	5.47	2.11	5.38	2.20	5.28	2.31
-17	4.86	1.63	4.75	1.70	4.70	1.79	4.62	1.87	4.59	1.96	5.84	1.94	5.70	2.02	5.64	2.12	5.55	2.22	5.51	2.32
-15	4.96	1.65	4.88	1.72	4.80	1.80	4.72	1.88	4.72	1.97	5.95	1.96	5.86	2.04	5.76	2.14	5.66	2.23	5.66	2.34
-13	5.15	1.66	5.07	1.73	4.99	1.82	4.91	1.90	4.91	1.98	6.18	1.97	6.09	2.06	5.99	2.16	5.89	2.25	5.89	2.35
-11	5.34	1.67	5.26	1.75	5.18	1.83	5.10	1.91	5.10	2.00	6.41	1.99	6.32	2.07	6.22	2.17	6.12	2.27	6.12	2.37
-10	5.44	1.69	5.36	1.76	5.28	1.84	5.20	1.92	5.20	2.01	6.53	2.00	6.43	2.09	6.34	2.19	6.24	2.28	6.24	2.39
-9	5.57	1.70	5.49	1.77	5.42	1.86	5.36	1.94	5.36	2.03	6.68	2.02	6.59	2.11	6.51	2.21	6.43	2.30	6.43	2.40
-7	5.82	1.72	5.74	1.79	5.71	1.87	5.68	1.95	5.68	2.04	6.99	2.04	6.89	2.12	6.85	2.22	6.82	2.32	6.82	2.42
-6	5.95	1.73	5.87	1.80	5.86	1.88	5.84	1.96	5.84	2.05	7.14	2.05	7.05	2.14	7.03	2.24	7.01	2.33	7.01	2.44
-5	6.08	1.74	6.00	1.82	6.00	1.90	6.00	1.98	6.00	2.07	7.30	2.07	7.20	2.16	7.20	2.26	7.20	2.35	7.20	2.45
-3	6.43	1.76	6.38	1.83	6.35	1.91	6.35	1.99	6.32	2.08	7.72	2.09	7.66	2.17	7.62	2.27	7.62	2.37	7.58	2.47
-1	6.78	1.77	6.77	1.84	6.70	1.93	6.70	2.01	6.64	2.09	8.14	2.10	8.12	2.19	8.04	2.29	8.04	2.38	7.97	2.49
0	6.96	1.79	6.96	1.86	6.88	1.94	6.88	2.02	6.80	2.11	8.35	2.12	8.35	2.21	8.26	2.30	8.26	2.40	8.16	2.50
1	7.15	1.80	7.15	1.87	7.07	1.95	7.06	2.03	6.98	2.12	8.58	2.14	8.58	2.22	8.49	2.32	8.47	2.42	8.37	2.52
3	7.54	1.81	7.54	1.89	7.46	1.97	7.41	2.05	7.33	2.14	9.04	2.15	9.04	2.24	8.95	2.34	8.89	2.43	8.79	2.54
5	7.92	1.83	7.92	1.90	7.84	1.98	7.76	2.06	7.68	2.15	9.50	2.17	9.50	2.26	9.41	2.35	9.31	2.45	9.22	2.55
6	8.16	1.84	8.08	1.91	8.00	2.00	7.92	2.08	7.84	2.16	9.79	2.19	9.70	2.27	9.60	2.37	9.50	2.47	9.41	2.57
7	8.34	1.86	8.24	1.93	8.18	2.01	8.10	2.09	8.00	2.18	10.01	2.20	9.89	2.29	9.82	2.39	9.72	2.48	9.60	2.59
9	8.70	1.87	8.56	1.94	8.54	2.02	8.46	2.10	8.32	2.19	10.44	2.22	10.27	2.31	10.25	2.40	10.15	2.50	9.98	2.60
10	8.88	1.88	8.72	1.96	8.72	2.04	8.64	2.12	8.48	2.21	10.66	2.24	10.46	2.32	10.46	2.42	10.37	2.52	10.18	2.62
11	8.94	1.90	8.78	1.97	8.77	2.05	8.69	2.13	8.53	2.22	10.73	2.25	10.54	2.34	10.52	2.44	10.43	2.53	10.23	2.64
14	9.14	1.91	8.98	1.98	8.91	2.07	8.83	2.15	8.67	2.23	10.96	2.27	10.77	2.36	10.69	2.45	10.60	2.55	10.41	2.65
15	9.20	1.93	9.04	2.00	8.96	2.08	8.88	2.16	8.72	2.25	11.04	2.29	10.85	2.37	10.75	2.47	10.66	2.57	10.46	2.67

To	Total power of combined indoor units (70%)										Total power of combined indoor units (80%)									
	Ti										Ti									
	16		18		20		22		24		16		18		20		22		24	
	CAP	IPT	CAP	IPT	CAP	IPT	CAP	IPT	CAP	IPT	CAP	IPT	CAP	IPT	CAP	IPT	CAP	IPT	CAP	IPT
-20	6.61	2.23	6.38	2.32	6.38	2.44	6.27	2.55	6.16	2.67	7.55	2.60	7.30	2.71	7.30	2.84	7.17	2.97	7.04	3.11
-17	6.81	2.24	6.65	2.34	6.59	2.46	6.47	2.57	6.43	2.69	7.78	2.62	7.60	2.73	7.53	2.87	7.40	3.00	7.35	3.14
-15	6.94	2.26	6.83	2.36	6.72	2.48	6.61	2.59	6.61	2.71	7.94	2.64	7.81	2.76	7.68	2.89	7.55	3.02	7.55	3.16
-13	7.21	2.28	7.10	2.38	6.99	2.50	6.88	2.61	6.88	2.73	8.24	2.66	8.12	2.78	7.99	2.91	7.86	3.04	7.86	3.18
-11	7.48	2.30	7.37	2.40	7.26	2.51	7.15	2.62	7.15	2.75	8.55	2.69	8.42	2.80	8.29	2.93	8.17	3.06	8.17	3.20
-10	7.62	2.32	7.50	2.42	7.39	2.53	7.28	2.64	7.28	2.77	8.70	2.71	8.58	2.82	8.45	2.96	8.32	3.08	8.32	3.23
-9	7.80	2.34	7.68	2.44	7.59	2.55	7.50	2.66	7.50	2.78	8.91	2.73	8.78	2.85	8.68	2.98	8.58	3.11	8.58	3.25
-7	8.15	2.36	8.04	2.46	8.00	2.57	7.95	2.68	7.95	2.80	9.32	2.75	9.19	2.87	9.14	3.00	9.09	3.13	9.09	3.27
-6	8.33	2.38	8.22	2.48	8.20	2.59	8.18	2.70	8.18	2.82	9.52	2.78	9.40	2.89	9.37	3.02	9.34	3.15	9.34	3.29
-5	8.51	2.40	8.40	2.50	8.40	2.61	8.40	2.72	8.40	2.84	9.73	2.80	9.60	2.91	9.60	3.05	9.60	3.17	9.60	3.32
-3	9.00	2.42	8.94	2.52	8.89	2.63	8.89	2.74	8.85	2.86	10.29	2.82	10.21	2.94	10.16	3.07	10.16	3.20	10.11	3.34
-1	9.50	2.44	9.48	2.54	9.39	2.65	9.39	2.76	9.30	2.88	10.85	2.84	10.83	2.96	10.73	3.09	10.73	3.22	10.62	3.36
0	9.74	2.46	9.74	2.56	9.63	2.67	9.63	2.78	9.52	2.90	11.14	2.87	11.14	2.98	11.01	3.11	11.01	3.24	10.88	3.38
1	10.01	2.48	10.01	2.57	9.90	2.69	9.88	2.80	9.77	2.92	11.44	2.89	11.44	3.00	11.32	3.14	11.29	3.26	11.16	3.41
3	10.55	2.49	10.55	2.59	10.44	2.71	10.37	2.82	10.26	2.94	12.06	2.91	12.06	3.03	11.93	3.16	11.85	3.29	11.72	3.43
5	11.09	2.51	11.09	2.61	10.98	2.73	10.86	2.84	10.75	2.96	12.67	2.93	12.67	3.05	12.54	3.18	12.42	3.31	12.29	3.45
6	11.42	2.53	11.31	2.63	11.20	2.75	11.09	2.86	10.98	2.98	13.06	2.96	12.93	3.07	12.80	3.20	12.67	3.33	12.54	3.47
7	11.68	2.55	11.54	2.65	11.45	2.76	11.34	2.87	11.20	3.00	13.34	2.98	13.18	3.09	13.09	3.23	12.96	3.35	12.80	3.50
9	12.18	2.57	11.98	2.67	11.96	2.78	11.84	2.89	11.65	3.02	13.92	3.00	13.70	3.12	13.66	3.25	13.54	3.38	13.31	3.52
10	12.43	2.59	12.21	2.69	12.21	2.80	12.10	2.91	11.87	3.03	14.21	3.02	13.95	3.14	13.95	3.27	13.82	3.40	13.57	3.54
11	12.52	2.61	12.30	2.71	12.28	2.82	12.16	2.93	11.94	3.05	14.31	3.04	14.05	3.16	14.03	3.29	13.90	3.42	13.64	3.56
14	12.79	2.63	12.57	2.73	12.48	2.84	12.36	2.95	12.14	3.07	14.62	3.07	14.36	3.18	14.26	3.32	14.13	3.44	13.88	3.58
15	12.88	2.65	12.66	2.75	12.54	2.86	12.43	2.97	12.21	3.09	14.72	3.09	14.46	3.21	14.34	3.34	14.21	3.47	13.95	3.61

To	Total power of combined indoor units (90%)										Total power of combined indoor units (100%)									
	Ti										Ti									
	16		18		20		22		24		16		18		20		22		24	
	CAP	IPT	CAP	IPT	CAP	IPT	CAP	IPT	CAP	IPT	CAP	IPT	CAP	IPT	CAP	IPT	CAP	IPT	CAP	IPT
-20	8.50	2.97	8.21	3.10	8.21	3.25	8.06	3.40	7.92	3.56	9.44	3.37	9.12	3.52	9.12	3.69	8.96	3.86	8.80	4.04
-17	8.76	2.99	8.55	3.12	8.47	3.28	8.32	3.42	8.27	3.58	9.73	3.40	9.50	3.55	9.41	3.72	9.25	3.89	9.18	4.07
-15	8.93	3.02	8.78	3.15	8.64	3.30	8.50	3.45	8.50	3.61	9.92	3.43	9.76	3.58	9.60	3.75	9.44	3.92	9.44	4.10
-13	9.27	3.04	9.13	3.18	8.99	3.33	8.84	3.47	8.84	3.64	10.30	3.46	10.14	3.61	9.98	3.78	9.82	3.95	9.82	4.13
-11	9.62	3.07	9.48	3.20	9.33	3.35	9.19	3.50	9.19	3.66	10.69	3.49	10.53	3.64	10.37	3.81	10.21	3.98	10.21	4.16
-10	9.79	3.10	9.65	3.23	9.50	3.38	9.36	3.53	9.36	3.69	10.88	3.52	10.72	3.67	10.56	3.84	10.40	4.01	10.40	4.19
-9	10.02	3.12	9.88	3.25	9.76	3.40	9.65	3.55	9.65	3.71	11.14	3.55	10.98	3.70	10.85	3.87	10.72	4.04	10.72	4.22
-7	10.48	3.15	10.34	3.28	10.28	3.43	10.22	3.58	10.22	3.74	11.65	3.58	11.49	3.73	11.42	3.90	11.36	4.06	11.36	4.25
-6	10.71	3.17	10.57	3.30	10.54	3.46	10.51	3.60	10.51	3.76	11.90	3.60	11.74	3.75	11.71	3.93	11.68	4.09	11.68	4.28
-5	10.94	3.20	10.80	3.33	10.80	3.48	10.80	3.63	10.80	3.79	12.16	3.63	12.00	3.78	12.00	3.96	12.00	4.12	12.00	4.31
-3	11.58	3.22	11.49	3.36	11.43	3.51	11.43	3.65	11.38	3.82	12.86	3.66	12.77	3.81	12.70	3.99	12.70	4.15	12.64	4.34
-1	12.21	3.25	12.18	3.38	12.07	3.53	12.07	3.68	11.95	3.84	13.57	3.69	13.54	3.84	13.41	4.01	13.41	4.18	13.28	4.36
0	12.53	3.27	12.53	3.41	12.38	3.56	12.38	3.70	12.24	3.87	13.92	3.72	13.92	3.87	13.76	4.04	13.76	4.21	13.60	4.39
1	12.87	3.30	12.87	3.43	12.73	3.58	12.70	3.73	12.56	3.89	14.30	3.75	14.30	3.90	14.14	4.07	14.11	4.24	13.95	4.42
3	13.56	3.33	13.56	3.46	13.42	3.61	13.33	3.76	13.19	3.92	15.07	3.78	15.07	3.93	14.91	4.10	14.82	4.27	14.66	4.45
5	14.26	3.35	14.26	3.48	14.11	3.64	13.97	3.78	13.82	3.94	15.84	3.81	15.84	3.96	15.68	4.13	15.52	4.30	15.36	4.48
6	14.69	3.38	14.54	3.51	14.40	3.66	14.26	3.81	14.11	3.97	16.32	3.84	16.16	3.99	16.00	4.16	15.84	4.33	15.68	4.51
7	15.01	3.40	14.83	3.53	14.72	3.69	14.58	3.83	14.40	3.99	16.68	3.87	16.48	4.02	16.36	4.19	16.20	4.36	16.00	4.54
9	15.66	3.43	15.41	3.56	15.37	3.71	15.23	3.86	14.98	4.02	17.40	3.90	17.12	4.05	17.08	4.22	16.92	4.38	16.64	4.57
10	15.98	3.45	15.70	3.59	15.70	3.74	15.55	3.88	15.26	4.05	17.76	3.93	17.44	4.08	17.44	4.25	17.28	4.41	16.96	4.60
11	16.10	3.48	15.81	3.61	15.78	3.76	15.64	3.91	15.35	4.07	17.89	3.95	17.57	4.10	17.54	4.28	17.38	4.44	17.06	4.63
14	16.44	3.51	16.16	3.64	16.04	3.79	15.90	3.94	15.61	4.10	18.27	3.98	17.95	4.13	17.82	4.31	17.66	4.47	17.34	4.66
15	16.56	3.53	16.27	3.66	16.13	3.81	15.98	3.96	15.70	4.12	18.40	4.01	18.08	4.16	17.92	4.33	17.76	4.50	17.44	4.68

4

To	Total power of combined indoor units (110%)										Total power of combined indoor units (120%)									
	Ti										Ti									
	16		18		20		22		24		16		18		20		22		24	
	CAP	IPT	CAP	IPT	CAP	IPT	CAP	IPT	CAP	IPT	CAP	IPT	CAP	IPT	CAP	IPT	CAP	IPT	CAP	IPT
-20	9.44	3.24	9.12	3.38	9.12	3.55	8.96	3.71	8.80	3.88	9.44	3.14	9.12	3.28	9.12	3.44	8.96	3.59	8.80	3.76
-17	9.73	3.26	9.50	3.41	9.41	3.57	9.25	3.73	9.18	3.91	9.73	3.16	9.50	3.30	9.41	3.46	9.25	3.62	9.18	3.79
-15	9.92	3.29	9.76	3.44	9.60	3.60	9.44	3.76	9.44	3.94	9.92	3.19	9.76	3.33	9.60	3.49	9.44	3.64	9.44	3.82
-13	10.30	3.32	10.14	3.46	9.98	3.63	9.82	3.79	9.82	3.97	10.30	3.22	10.14	3.36	9.98	3.52	9.82	3.67	9.82	3.84
-11	10.69	3.35	10.53	3.49	10.37	3.66	10.21	3.82	10.21	3.99	10.69	3.24	10.53	3.38	10.37	3.54	10.21	3.70	10.21	3.87
-10	10.88	3.38	10.72	3.52	10.56	3.69	10.40	3.85	10.40	4.02	10.88	3.27	10.72	3.41	10.56	3.57	10.40	3.73	10.40	3.90
-9	11.14	3.40	10.98	3.55	10.85	3.71	10.72	3.87	10.72	4.05	11.14	3.30	10.98	3.44	10.85	3.60	10.72	3.75	10.72	3.92
-7	11.65	3.43	11.49	3.58	11.42	3.74	11.36	3.90	11.36	4.08	11.65	3.33	11.49	3.46	11.42	3.63	11.36	3.78	11.36	3.95
-6	11.90	3.46	11.74	3.60	11.71	3.77	11.68	3.93	11.68	4.11	11.90	3.35	11.74	3.49	11.71	3.65	11.68	3.81	11.68	3.98
-5	12.16	3.49	12.00	3.63	12.00	3.80	12.00	3.96	12.00	4.13	12.16	3.38	12.00	3.52	12.00	3.68	12.00	3.83	12.00	4.00
-3	12.86	3.52	12.77	3.66	12.70	3.83	12.70	3.99	12.64	4.16	12.86	3.41	12.77	3.55	12.70	3.71	12.70	3.86	12.64	4.03
-1	13.57	3.54	13.54	3.69	13.41	3.85	13.41	4.01	13.28	4.19	13.57	3.43	13.54	3.57	13.41	3.73	13.41	3.89	13.28	4.06
0	13.92	3.57	13.92	3.72	13.76	3.88	13.76	4.04	13.60	4.22	13.92	3.46	13.92	3.60	13.76	3.76	13.76	3.92	13.60	4.09
1	14.30	3.60	14.30	3.74	14.14	3.91	14.11	4.07	13.95	4.25	14.30	3.49	14.30	3.63	14.14	3.79	14.11	3.94	13.95	4.11
3	15.07	3.63	15.07	3.77	14.91	3.94	14.82	4.10	14.66	4.27	15.07	3.51	15.07	3.65	14.91	3.81	14.82	3.97	14.66	4.14
5	15.84	3.66	15.84	3.80	15.68	3.97	15.52	4.13	15.36	4.30	15.84	3.54	15.84	3.68	15.68	3.84	15.52	4.00	15.36	4.17
6	16.32	3.68	16.16	3.83	16.00	3.99	15.84	4.15	15.68	4.33	16.32	3.57	16.16	3.71	16.00	3.87	15.84	4.02	15.68	4.19
7	16.68	3.71	16.48	3.86	16.36	4.02	16.20	4.18	16.00	4.36	16.68	3.60	16.48	3.74	16.36	3.90	16.20	4.05	16.00	4.22
9	17.40	3.74	17.12	3.88	17.08	4.05	16.92	4.21	16.64	4.39	17.40	3.62	17.12	3.76	17.08	3.92	16.92	4.08	16.64	4.25
10	17.76	3.77	17.44	3.91	17.44	4.08	17.28	4.24	16.96	4.41	17.76	3.65	17.44	3.79	17.44	3.95	17.28	4.11	16.96	4.28
11	17.89	3.80	17.57	3.94	17.54	4.11	17.38	4.27	17.06	4.44	17.89	3.68	17.57	3.82	17.54	3.98	17.38	4.13	17.06	4.30
14	18.27	3.82	17.95	3.97	17.82	4.13	17.66	4.29	17.34	4.47	18.27	3.70	17.95	3.84	17.82	4.00	17.66	4.16	17.34	4.33
15	18.40	3.85	18.08	4.00	17.92	4.16	17.76	4.32	17.44	4.50	18.40	3.73	18.08	3.87	17.92	4.03	17.76	4.19	17.44	4.36

To	Total power of combined indoor units (130%)									
	Ti									
	16		18		20		22		24	
	CAP	IPT	CAP	IPT	CAP	IPT	CAP	IPT	CAP	IPT
-20	9.44	3.00	9.12	3.13	9.12	3.29	8.96	3.44	8.80	3.60
-17	9.73	3.03	9.50	3.16	9.41	3.31	9.25	3.46	9.18	3.63
-15	9.92	3.05	9.76	3.19	9.60	3.34	9.44	3.49	9.44	3.65
-13	10.30	3.08	10.14	3.21	9.98	3.37	9.82	3.51	9.82	3.68
-11	10.69	3.10	10.53	3.24	10.37	3.39	10.21	3.54	10.21	3.70
-10	10.88	3.13	10.72	3.26	10.56	3.42	10.40	3.57	10.40	3.73
-9	11.14	3.16	10.98	3.29	10.85	3.44	10.72	3.59	10.72	3.75
-7	11.65	3.18	11.49	3.32	11.42	3.47	11.36	3.62	11.36	3.78
-6	11.90	3.21	11.74	3.34	11.71	3.50	11.68	3.64	11.68	3.81
-5	12.16	3.23	12.00	3.37	12.00	3.52	12.00	3.67	12.00	3.83
-3	12.86	3.26	12.77	3.39	12.70	3.55	12.70	3.70	12.64	3.86
-1	13.57	3.29	13.54	3.42	13.41	3.57	13.41	3.72	13.28	3.88
0	13.92	3.31	13.92	3.45	13.76	3.60	13.76	3.75	13.60	3.91
1	14.30	3.34	14.30	3.47	14.14	3.62	14.11	3.77	13.95	3.94
3	15.07	3.36	15.07	3.50	14.91	3.65	14.82	3.80	14.66	3.96
5	15.84	3.39	15.84	3.52	15.68	3.68	15.52	3.82	15.36	3.99
6	16.32	3.42	16.16	3.55	16.00	3.70	15.84	3.85	15.68	4.01
7	16.68	3.44	16.48	3.58	16.36	3.73	16.20	3.88	16.00	4.04
9	17.40	3.47	17.12	3.60	17.08	3.75	16.92	3.90	16.64	4.07
10	17.76	3.49	17.44	3.63	17.44	3.78	17.28	3.93	16.96	4.09
11	17.89	3.52	17.57	3.65	17.54	3.81	17.38	3.95	17.06	4.12
14	18.27	3.55	17.95	3.68	17.82	3.83	17.66	3.98	17.34	4.14
15	18.40	3.57	18.08	3.70	17.92	3.86	17.76	4.01	17.44	4.17

RAS-6FSNY2E

To	Total power of combined indoor units (50%)										Total power of combined indoor units (60%)									
	Ti										Ti									
	16		18		20		22		24		16		18		20		22		24	
	CAP	IPT	CAP	IPT	CAP	IPT	CAP	IPT	CAP	IPT	CAP	IPT	CAP	IPT	CAP	IPT	CAP	IPT	CAP	IPT
-20	5.13	1.89	4.95	1.97	4.95	2.07	4.86	2.16	4.86	2.26	6.16	2.24	5.94	2.34	5.94	2.45	5.83	2.57	5.83	2.69
-17	5.40	1.90	5.27	1.99	5.22	2.08	5.13	2.18	5.13	2.28	6.48	2.26	6.33	2.36	6.26	2.47	6.16	2.58	6.16	2.71
-15	5.58	1.92	5.49	2.00	5.40	2.10	5.31	2.19	5.31	2.30	6.70	2.28	6.59	2.38	6.48	2.49	6.37	2.60	6.37	2.73
-13	5.83	1.94	5.74	2.02	5.62	2.12	5.53	2.21	5.53	2.31	7.00	2.30	6.89	2.40	6.74	2.51	6.63	2.62	6.63	2.75
-11	6.08	1.95	5.99	2.04	5.83	2.13	5.74	2.23	5.74	2.33	7.30	2.32	7.19	2.42	7.00	2.53	6.89	2.64	6.89	2.76
-10	6.21	1.97	6.12	2.05	5.94	2.15	5.85	2.24	5.85	2.34	7.45	2.34	7.34	2.44	7.13	2.55	7.02	2.66	7.02	2.78
-9	6.32	1.98	6.25	2.07	6.10	2.17	6.03	2.26	6.03	2.36	7.58	2.36	7.50	2.46	7.32	2.57	7.24	2.68	7.24	2.80
-7	6.53	2.00	6.50	2.08	6.43	2.18	6.39	2.27	6.39	2.38	7.84	2.38	7.80	2.48	7.71	2.59	7.67	2.70	7.67	2.82
-6	6.64	2.02	6.62	2.10	6.59	2.20	6.57	2.29	6.57	2.39	7.97	2.40	7.95	2.50	7.91	2.61	7.88	2.72	7.88	2.84
-5	6.75	2.03	6.75	2.12	6.75	2.21	6.75	2.31	6.75	2.41	8.10	2.41	8.10	2.51	8.10	2.63	8.10	2.74	8.10	2.86
-3	7.18	2.05	7.18	2.13	7.15	2.23	7.15	2.32	7.11	2.43	8.62	2.43	8.62	2.53	8.58	2.65	8.58	2.76	8.53	2.88
-1	7.61	2.07	7.61	2.15	7.54	2.25	7.54	2.34	7.47	2.44	9.14	2.45	9.14	2.55	9.05	2.67	9.05	2.78	8.96	2.90
0	7.83	2.08	7.83	2.17	7.74	2.26	7.74	2.36	7.65	2.46	9.40	2.47	9.40	2.57	9.29	2.69	9.29	2.80	9.18	2.92
1	8.05	2.10	8.05	2.18	7.96	2.28	7.94	2.37	7.85	2.47	9.66	2.49	9.66	2.59	9.55	2.71	9.53	2.82	9.42	2.94
3	8.48	2.12	8.48	2.20	8.39	2.30	8.33	2.39	8.24	2.49	10.17	2.51	10.17	2.61	10.07	2.73	10.00	2.84	9.89	2.96
5	8.91	2.13	8.91	2.22	8.82	2.31	8.73	2.40	8.64	2.51	10.69	2.53	10.69	2.63	10.58	2.75	10.48	2.86	10.37	2.98
6	9.09	2.15	9.09	2.23	9.00	2.33	8.91	2.42	8.82	2.52	10.91	2.55	10.91	2.65	10.80	2.76	10.69	2.88	10.58	3.00
7	9.29	2.16	9.27	2.25	9.20	2.34	9.09	2.44	9.00	2.54	11.15	2.57	11.12	2.67	11.04	2.78	10.91	2.89	10.80	3.02
9	9.70	2.18	9.63	2.26	9.61	2.36	9.45	2.45	9.36	2.56	11.64	2.59	11.56	2.69	11.53	2.80	11.34	2.91	11.23	3.04
10	9.90	2.20	9.81	2.28	9.81	2.38	9.63	2.47	9.54	2.57	11.88	2.61	11.77	2.71	11.77	2.82	11.56	2.93	11.45	3.06
11	9.97	2.21	9.90	2.30	9.90	2.39	9.74	2.49	9.65	2.59	11.97	2.63	11.88	2.73	11.88	2.84	11.69	2.95	11.58	3.07
14	10.19	2.23	10.17	2.31	10.17	2.41	10.06	2.50	9.97	2.61	12.23	2.65	12.20	2.75	12.20	2.86	12.07	2.97	11.97	3.09
15	10.26	2.25	10.26	2.33	10.26	2.43	10.17	2.52	10.08	2.62	12.31	2.67	12.31	2.77	12.31	2.88	12.20	2.99	12.10	3.11

To	Total power of combined indoor units (70%)										Total power of combined indoor units (80%)									
	Ti										Ti									
	16		18		20		22		24		16		18		20		22		24	
	CAP	IPT	CAP	IPT	CAP	IPT	CAP	IPT	CAP	IPT	CAP	IPT	CAP	IPT	CAP	IPT	CAP	IPT	CAP	IPT
-20	7.18	2.59	6.93	2.71	6.93	2.84	6.80	2.97	6.80	3.11	8.21	3.03	7.92	3.16	7.92	3.32	7.78	3.47	7.78	3.63
-17	7.56	2.62	7.38	2.73	7.31	2.86	7.18	2.99	7.18	3.13	8.64	3.05	8.44	3.19	8.35	3.34	8.21	3.49	8.21	3.66
-15	7.81	2.64	7.69	2.75	7.56	2.89	7.43	3.02	7.43	3.16	8.93	3.08	8.78	3.21	8.64	3.37	8.50	3.52	8.50	3.68
-13	8.16	2.66	8.04	2.78	7.86	2.91	7.74	3.04	7.74	3.18	9.33	3.11	9.19	3.24	8.99	3.39	8.84	3.54	8.84	3.71
-11	8.52	2.68	8.39	2.80	8.16	2.93	8.04	3.06	8.04	3.20	9.73	3.13	9.59	3.27	9.33	3.42	9.19	3.57	9.19	3.73
-10	8.69	2.71	8.57	2.82	8.32	2.95	8.19	3.08	8.19	3.22	9.94	3.16	9.79	3.29	9.50	3.45	9.36	3.60	9.36	3.76
-9	8.85	2.73	8.74	2.84	8.54	2.98	8.44	3.11	8.44	3.25	10.11	3.18	9.99	3.32	9.76	3.47	9.65	3.62	9.65	3.79
-7	9.15	2.75	9.10	2.87	9.00	3.00	8.95	3.13	8.95	3.27	10.45	3.21	10.40	3.34	10.28	3.50	10.22	3.65	10.22	3.81
-6	9.30	2.77	9.27	2.89	9.22	3.02	9.20	3.15	9.20	3.29	10.63	3.24	10.60	3.37	10.54	3.53	10.51	3.67	10.51	3.84
-5	9.45	2.80	9.45	2.91	9.45	3.04	9.45	3.17	9.45	3.31	10.80	3.26	10.80	3.40	10.80	3.55	10.80	3.70	10.80	3.87
-3	10.05	2.82	10.05	2.93	10.00	3.07	10.00	3.19	9.95	3.34	11.49	3.29	11.49	3.42	11.43	3.58	11.43	3.73	11.38	3.89
-1	10.66	2.84	10.66	2.96	10.56	3.09	10.56	3.22	10.46	3.36	12.18	3.31	12.18	3.45	12.07	3.60	12.07	3.75	11.95	3.92
0	10.96	2.86	10.96	2.98	10.84	3.11	10.84	3.24	10.71	3.38	12.53	3.34	12.53	3.48	12.38	3.63	12.38	3.78	12.24	3.94
1	11.26	2.89	11.26	3.00	11.14	3.13	11.11	3.26	10.99	3.40	12.87	3.37	12.87	3.50	12.73	3.66	12.70	3.81	12.56	3.97
3	11.87	2.91	11.87	3.02	11.74	3.16	11.67	3.28	11.54	3.43	13.56	3.39	13.56	3.53	13.42	3.68	13.33	3.83	13.19	4.00
5	12.47	2.93	12.47	3.05	12.35	3.18	12.22	3.31	12.10	3.45	14.26	3.42	14.26	3.55	14.11	3.71	13.97	3.86	13.82	4.02
6	12.73	2.95	12.73	3.07	12.60	3.20	12.47	3.33	12.35	3.47	14.54	3.45	14.54	3.58	14.40	3.73	14.26	3.88	14.11	4.05
7	13.01	2.98	12.98	3.09	12.88	3.22	12.73	3.35	12.60	3.49	14.87	3.47	14.83	3.61	14.72	3.76	14.54	3.91	14.40	4.07
9	13.58	3.00	13.48	3.11	13.45	3.25	13.23	3.37	13.10	3.52	15.52	3.50	15.41	3.63	15.37	3.79	15.12	3.94	14.98	4.10
10	13.86	3.02	13.73	3.14	13.73	3.27	13.48	3.40	13.36	3.54	15.84	3.52	15.70	3.66	15.70	3.81	15.41	3.96	15.26	4.13
11	13.96	3.04	13.86	3.16	13.86	3.29	13.63	3.42	13.51	3.56	15.96	3.55	15.84	3.68	15.84	3.84	15.58	3.99	15.44	4.15
14	14.26	3.07	14.24	3.18	14.24	3.31	14.09	3.44	13.96	3.58	16.30	3.58	16.27	3.71	16.27	3.87	16.10	4.01	15.96	4.18
15	14.36	3.09	14.36	3.20	14.36	3.34	14.24	3.46	14.11	3.60	16.42	3.60	16.42	3.74	16.42	3.89	16.27	4.04	16.13	4.21



To	Total power of combined indoor units (90%)										Total power of combined indoor units (100%)									
	Ti										Ti									
	16		18		20		22		24		16		18		20		22		24	
	CAP	IPT	CAP	IPT	CAP	IPT	CAP	IPT	CAP	IPT	CAP	IPT	CAP	IPT	CAP	IPT	CAP	IPT	CAP	IPT
-20	9.23	3.46	8.91	3.61	8.91	3.79	8.75	3.96	8.75	4.15	10.26	3.93	9.90	4.11	9.90	4.31	9.72	4.50	9.72	4.71
-17	9.72	3.49	9.49	3.64	9.40	3.82	9.23	3.99	9.23	4.18	10.80	3.97	10.55	4.14	10.44	4.34	10.26	4.54	10.26	4.75
-15	10.04	3.52	9.88	3.67	9.72	3.85	9.56	4.02	9.56	4.21	11.16	4.00	10.98	4.17	10.80	4.37	10.62	4.57	10.62	4.78
-13	10.50	3.55	10.34	3.70	10.11	3.88	9.95	4.05	9.95	4.24	11.66	4.03	11.48	4.21	11.23	4.41	11.05	4.60	11.05	4.82
-11	10.95	3.58	10.79	3.73	10.50	3.91	10.34	4.08	10.34	4.27	12.17	4.07	11.99	4.24	11.66	4.44	11.48	4.64	11.48	4.85
-10	11.18	3.61	11.02	3.76	10.69	3.94	10.53	4.11	10.53	4.30	12.42	4.10	12.24	4.28	11.88	4.48	11.70	4.67	11.70	4.88
-9	11.37	3.64	11.24	3.79	10.98	3.97	10.85	4.14	10.85	4.33	12.64	4.13	12.49	4.31	12.20	4.51	12.06	4.70	12.06	4.92
-7	11.76	3.67	11.70	3.82	11.57	4.00	11.50	4.17	11.50	4.36	13.07	4.17	13.00	4.34	12.85	4.54	12.78	4.74	12.78	4.95
-6	11.96	3.70	11.92	3.85	11.86	4.03	11.83	4.20	11.83	4.39	13.28	4.20	13.25	4.38	13.18	4.58	13.14	4.77	13.14	4.99
-5	12.15	3.73	12.15	3.88	12.15	4.06	12.15	4.23	12.15	4.42	13.50	4.24	13.50	4.41	13.50	4.61	13.50	4.81	13.50	5.02
-3	12.93	3.76	12.93	3.91	12.86	4.09	12.86	4.26	12.80	4.45	14.36	4.27	14.36	4.45	14.29	4.65	14.29	4.84	14.22	5.05
-1	13.71	3.79	13.71	3.94	13.58	4.12	13.58	4.29	13.45	4.48	15.23	4.30	15.23	4.48	15.08	4.68	15.08	4.87	14.94	5.09
0	14.09	3.82	14.09	3.97	13.93	4.15	13.93	4.32	13.77	4.51	15.66	4.34	15.66	4.51	15.48	4.71	15.48	4.91	15.30	5.12
1	14.48	3.85	14.48	4.00	14.32	4.18	14.29	4.35	14.13	4.54	16.09	4.37	16.09	4.55	15.91	4.75	15.88	4.94	15.70	5.16
3	15.26	3.88	15.26	4.03	15.10	4.21	15.00	4.38	14.84	4.57	16.96	4.41	16.96	4.58	16.78	4.78	16.67	4.98	16.49	5.19
5	16.04	3.91	16.04	4.06	15.88	4.24	15.71	4.41	15.55	4.60	17.82	4.44	17.82	4.62	17.64	4.82	17.46	5.01	17.28	5.22
6	16.36	3.94	16.36	4.09	16.20	4.27	16.04	4.44	15.88	4.63	18.18	4.47	18.18	4.65	18.00	4.85	17.82	5.04	17.64	5.26
7	16.73	3.97	16.69	4.12	16.56	4.30	16.36	4.47	16.20	4.66	18.59	4.51	18.54	4.68	18.41	4.88	18.18	5.08	18.00	5.29
9	17.46	4.00	17.33	4.15	17.29	4.33	17.01	4.50	16.85	4.69	19.40	4.54	19.26	4.72	19.22	4.92	18.90	5.11	18.72	5.33
10	17.82	4.03	17.66	4.18	17.66	4.36	17.33	4.53	17.17	4.72	19.80	4.58	19.62	4.75	19.62	4.95	19.26	5.15	19.08	5.36
11	17.95	4.06	17.82	4.21	17.82	4.39	17.53	4.56	17.37	4.75	19.94	4.61	19.80	4.79	19.80	4.99	19.48	5.18	19.30	5.39
14	18.34	4.09	18.31	4.24	18.31	4.42	18.11	4.59	17.95	4.78	20.38	4.64	20.34	4.82	20.34	5.02	20.12	5.21	19.94	5.43
15	18.47	4.12	18.47	4.27	18.47	4.45	18.31	4.62	18.14	4.81	20.52	4.68	20.52	4.85	20.52	5.05	20.34	5.25	20.16	5.46

To	Total power of combined indoor units (110%)										Total power of combined indoor units (120%)									
	Ti										Ti									
	16		18		20		22		24		16		18		20		22		24	
	CAP	IPT	CAP	IPT	CAP	IPT	CAP	IPT	CAP	IPT	CAP	IPT	CAP	IPT	CAP	IPT	CAP	IPT	CAP	IPT
-20	10.26	3.77	9.90	3.94	9.90	4.13	9.72	4.32	9.72	4.53	10.26	3.66	9.90	3.82	9.90	4.01	9.72	4.19	9.72	4.38
-17	10.80	3.81	10.55	3.97	10.44	4.17	10.26	4.35	10.26	4.56	10.80	3.69	10.55	3.85	10.44	4.04	10.26	4.22	10.26	4.42
-15	11.16	3.84	10.98	4.01	10.80	4.20	10.62	4.39	10.62	4.59	11.16	3.72	10.98	3.88	10.80	4.07	10.62	4.25	10.62	4.45
-13	11.66	3.87	11.48	4.04	11.23	4.23	11.05	4.42	11.05	4.62	11.66	3.75	11.48	3.91	11.23	4.10	11.05	4.28	11.05	4.48
-11	12.17	3.90	11.99	4.07	11.66	4.26	11.48	4.45	11.48	4.66	12.17	3.78	11.99	3.94	11.66	4.13	11.48	4.31	11.48	4.51
-10	12.42	3.94	12.24	4.10	11.88	4.30	11.70	4.48	11.70	4.69	12.42	3.81	12.24	3.98	11.88	4.16	11.70	4.34	11.70	4.54
-9	12.64	3.97	12.49	4.14	12.20	4.33	12.06	4.52	12.06	4.72	12.64	3.85	12.49	4.01	12.20	4.19	12.06	4.38	12.06	4.57
-7	13.07	4.00	13.00	4.17	12.85	4.36	12.78	4.55	12.78	4.75	13.07	3.88	13.00	4.04	12.85	4.23	12.78	4.41	12.78	4.61
-6	13.28	4.03	13.25	4.20	13.18	4.40	13.14	4.58	13.14	4.79	13.28	3.91	13.25	4.07	13.18	4.26	13.14	4.44	13.14	4.64
-5	13.50	4.07	13.50	4.24	13.50	4.43	13.50	4.61	13.50	4.82	13.50	3.94	13.50	4.10	13.50	4.29	13.50	4.47	13.50	4.67
-3	14.36	4.10	14.36	4.27	14.29	4.46	14.29	4.65	14.22	4.85	14.36	3.97	14.36	4.13	14.29	4.32	14.29	4.50	14.22	4.70
-1	15.23	4.13	15.23	4.30	15.08	4.49	15.08	4.68	14.94	4.88	15.23	4.00	15.23	4.17	15.08	4.35	15.08	4.53	14.94	4.73
0	15.66	4.17	15.66	4.33	15.48	4.53	15.48	4.71	15.30	4.92	15.66	4.03	15.66	4.20	15.48	4.38	15.48	4.56	15.30	4.76
1	16.09	4.20	16.09	4.37	15.91	4.56	15.88	4.74	15.70	4.95	16.09	4.07	16.09	4.23	15.91	4.42	15.88	4.60	15.70	4.80
3	16.96	4.23	16.96	4.40	16.78	4.59	16.67	4.78	16.49	4.98	16.96	4.10	16.96	4.26	16.78	4.45	16.67	4.63	16.49	4.83
5	17.82	4.26	17.82	4.43	17.64	4.62	17.46	4.81	17.28	5.02	17.82	4.13	17.82	4.29	17.64	4.48	17.46	4.66	17.28	4.86
6	18.18	4.30	18.18	4.46	18.00	4.66	17.82	4.84	17.64	5.05	18.18	4.16	18.18	4.32	18.00	4.51	17.82	4.69	17.64	4.89
7	18.59	4.33	18.54	4.50	18.41	4.69	18.18	4.88	18.00	5.08	18.59	4.19	18.54	4.36	18.41	4.54	18.18	4.72	18.00	4.92
9	19.40	4.36	19.26	4.53	19.22	4.72	18.90	4.91	18.72	5.11	19.40	4.22	19.26	4.39	19.22	4.57	18.90	4.75	18.72	4.95
10	19.80	4.39	19.62	4.56	19.62	4.75	19.26	4.94	19.08	5.15	19.80	4.26	19.62	4.42	19.62	4.61	19.26	4.79	19.08	4.98
11	19.94	4.43	19.80	4.59	19.80	4.79	19.48	4.97	19.30	5.18	19.94	4.29	19.80	4.45	19.80	4.64	19.48	4.82	19.30	5.02
14	20.38	4.46	20.34	4.63	20.34	4.82	20.12	5.01	19.94	5.21	20.38	4.32	20.34	4.48	20.34	4.67	20.12	4.85	19.94	5.05
15	20.52	4.49	20.52	4.66	20.52	4.85	20.34	5.04	20.16	5.24	20.52	4.35	20.52	4.51	20.52	4.70	20.34	4.88	20.16	5.08

To	Total power of combined indoor units (130%)									
	Ti									
	16		18		20		22		24	
	CAP	IP T	CAP	IP T	CAP	IP T	CAP	IP T	CAP	IP T
-20	10.26	3.50	9.90	3.65	9.90	3.83	9.72	4.01	9.72	4.20
-17	10.80	3.53	10.55	3.68	10.44	3.86	10.26	4.04	10.26	4.23
-15	11.16	3.56	10.98	3.71	10.80	3.89	10.62	4.07	10.62	4.26
-13	11.66	3.59	11.48	3.75	11.23	3.92	11.05	4.10	11.05	4.29
-11	12.17	3.62	11.99	3.78	11.66	3.95	11.48	4.13	11.48	4.32
-10	12.42	3.65	12.24	3.81	11.88	3.98	11.70	4.16	11.70	4.35
-9	12.64	3.68	12.49	3.84	12.20	4.01	12.06	4.19	12.06	4.38
-7	13.07	3.71	13.00	3.87	12.85	4.04	12.78	4.22	12.78	4.41
-6	13.28	3.74	13.25	3.90	13.18	4.07	13.14	4.25	13.14	4.44
-5	13.50	3.77	13.50	3.93	13.50	4.10	13.50	4.28	13.50	4.47
-3	14.36	3.80	14.36	3.96	14.29	4.14	14.29	4.31	14.22	4.50
-1	15.23	3.83	15.23	3.99	15.08	4.17	15.08	4.34	14.94	4.53
0	15.66	3.86	15.66	4.02	15.48	4.20	15.48	4.37	15.30	4.56
1	16.09	3.89	16.09	4.05	15.91	4.23	15.88	4.40	15.70	4.59
3	16.96	3.92	16.96	4.08	16.78	4.26	16.67	4.43	16.49	4.62
5	17.82	3.95	17.82	4.11	17.64	4.29	17.46	4.46	17.28	4.65
6	18.18	3.98	18.18	4.14	18.00	4.32	17.82	4.49	17.64	4.68
7	18.59	4.01	18.54	4.17	18.41	4.35	18.18	4.52	18.00	4.71
9	19.40	4.04	19.26	4.20	19.22	4.38	18.90	4.55	18.72	4.74
10	19.80	4.07	19.62	4.23	19.62	4.41	19.26	4.58	19.08	4.77
11	19.94	4.10	19.80	4.26	19.80	4.44	19.48	4.61	19.30	4.80
14	20.38	4.13	20.34	4.29	20.34	4.47	20.12	4.64	19.94	4.83
15	20.52	4.16	20.52	4.32	20.52	4.50	20.34	4.67	20.16	4.86

4.4 Correction factors

4.4.1 Piping length correction factor

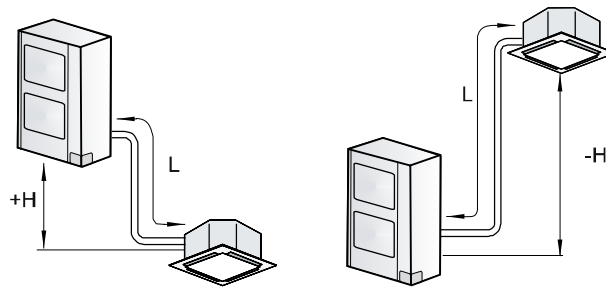

The correction factor is based on the equivalent piping length in meters (EL) and the height between outdoor and indoor units in meters (H).

H:

Height between outdoor unit and indoor unit (m).

- $H > 0$: Position of outdoor unit is higher than position of indoor unit (m).
- $H < 0$: Position of outdoor unit is lower than position of indoor unit (m).

L:

Actual one-way piping length between outdoor unit and indoor unit (m).

EL:

Equivalent one-way piping length between indoor unit and indoor unit (m).

- One 90° elbow is 0.5 m.
- One 180° bend is 1.5 m.
- One Multi-kit is 0.5 m.



NOTE

In order to ensure correct unit selection, consider the farthest indoor unit.

Cooling

RAS-4FS(V)N(Y)2E

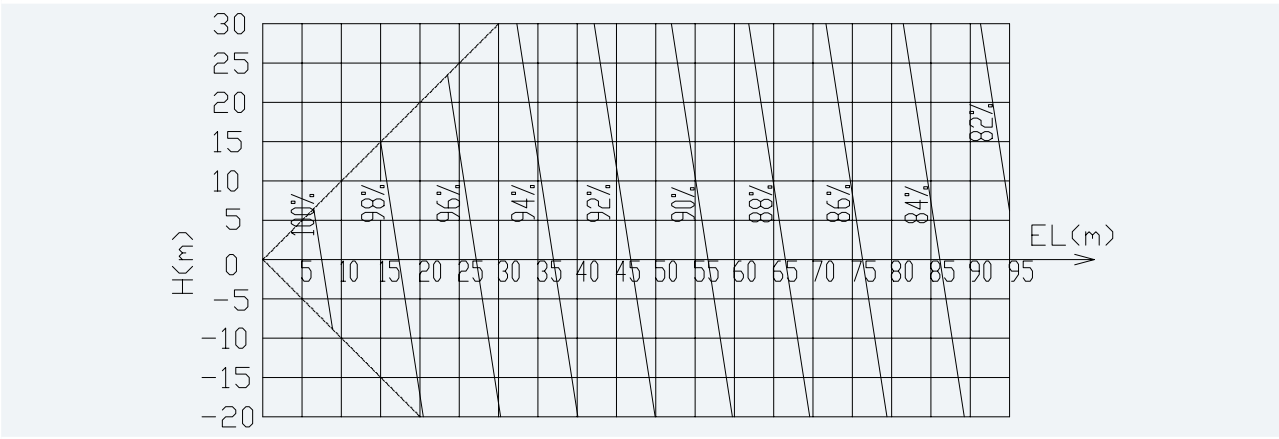

RAS-5FS(V)N(Y)2E

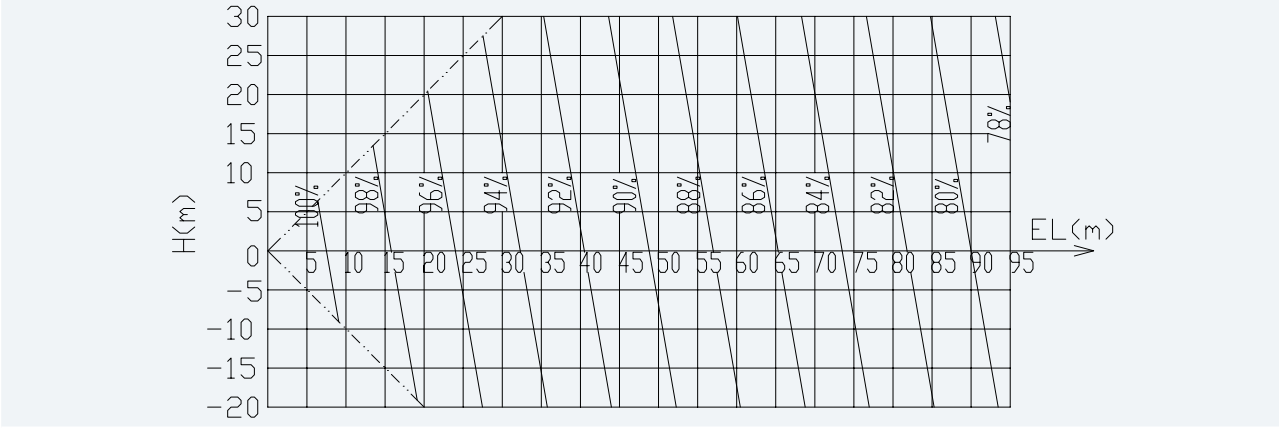

RAS-6FS(V)N(Y)2E

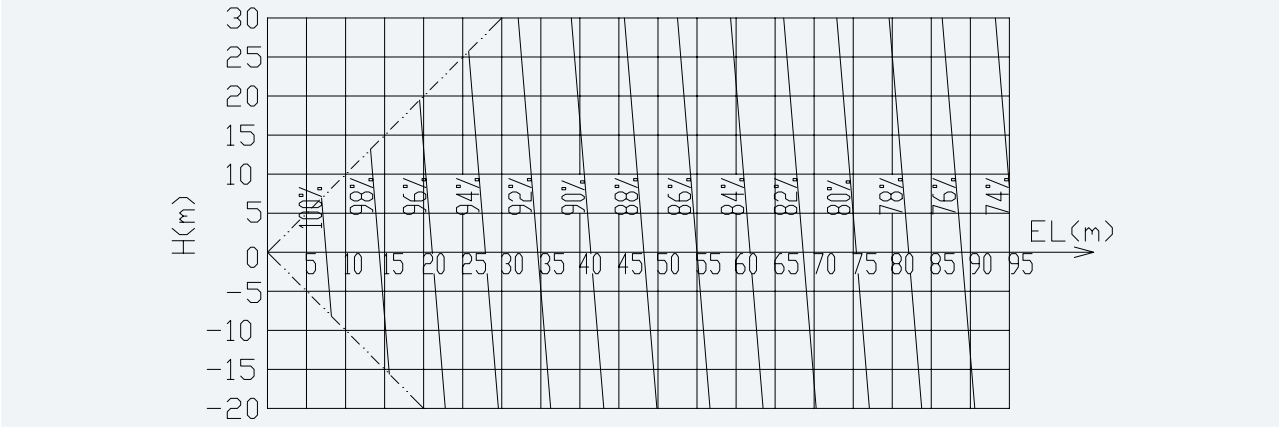

i NOTE

Cooling capacity

The cooling capacity should be corrected according to the following formula:

$$CCA = CC \times F$$

CCA: Actual corrected cooling capacity (kW).

CC: Cooling capacity in the cooling capacity table (kW).

F: Correction factor based on the equivalent piping length (in %).

Heating

RAS-4FS(V)N(Y)2E

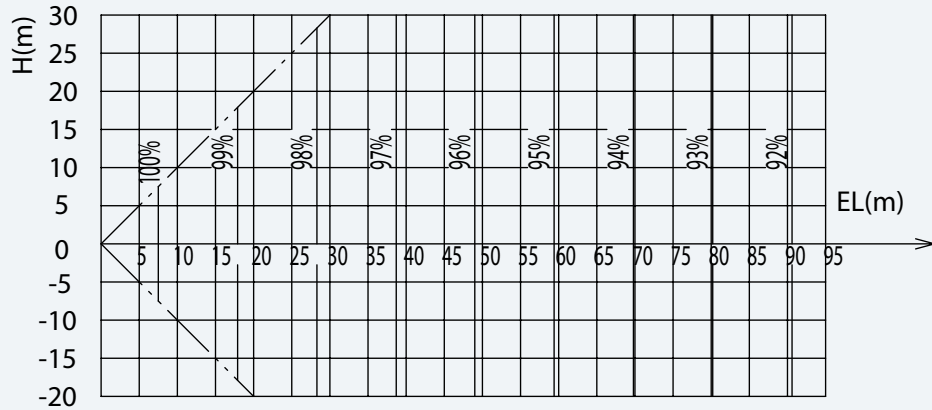

RAS-5FS(V)N(Y)2E

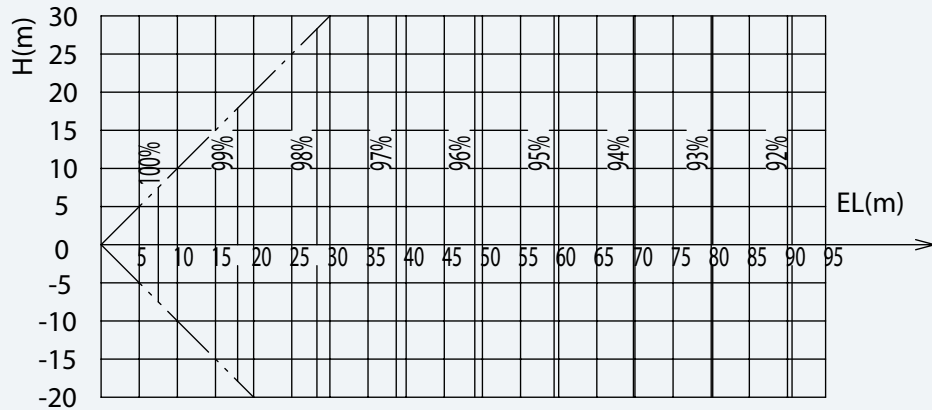

RAS-6FS(V)N(Y)2E

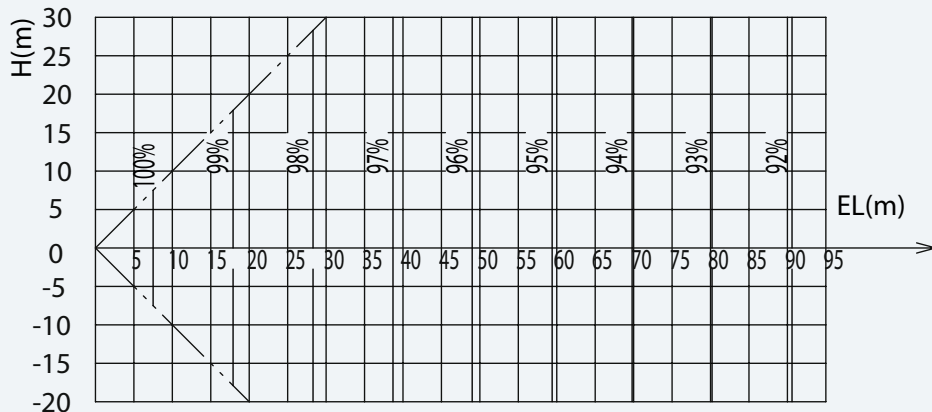

NOTE

Heating capacity

The heating capacity should be corrected according to the following formula:

$$HCA = HC \times F$$

HCA: Actual corrected heating capacity (kW).

HC: Heating capacity from heating capacity table (kW).

F: Correction factor based on the equivalent piping length (in %).

4.4.2 Defrost correction factor

The heating capacity does not include operation during frost or defrosting.

When this type of operation is taken in account, the heating capacity must be corrected according to the following equation:

$$\text{Corrected heating capacity} = (\text{correction factor}) \times (\text{heating capacity})$$

Ambient temperature (°C DB) (HR = 85%)	-20	-7	-5	-3	0	3	5	7
Defrost correction factor f_d	0.95	0.95	0.93	0.88	0.85	0.87	0.90	1.00



NOTE

- Defrost correction factor corresponds to a relative humidity of 85%. If the condition changes, the correction factor will be different.
- Defrost correction factor is not valid for special conditions such as during snow or operation in a transitional period.

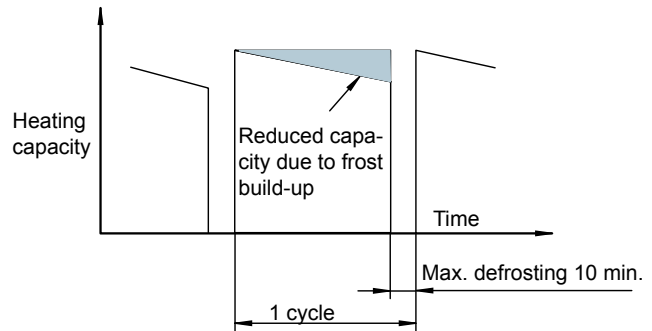

4.4.3 Correction ratio due to humidity (CR)

The cooling capacity data for the outdoor units is taken from the table in section “Nominal cooling capacity tables”, and it’s calculated on the basis of a relative humidity of 50%.

In some situations, it’s possible that the temperature condition of the ambient to be conditioned, specifies other different relative humidity, which affect at the Dry Bulb temperature. In this cases, it’s necessary to calculate the difference between the indoor air inlet dry bulb temperature required by the system and the indoor air inlet dry bulb temperature shown in the cooling capacity data.

This temperature difference requires an adjustment of the sensible heat capacity for the indoor units.

This coefficient corrects the sensible heat capacity of a unit according to the relative humidity of the air entering the indoor unit. The greater the relative humidity the lower will be the sensible heat capacity and vice versa.

Model	CR
RAS-4FS(V)N(Y)2E	0.44
RAS-5FS(V)N(Y)2E	0.61
RAS-6FS(V)N(Y)2E	0.66

5. Acoustic characteristic curves

Index

5.1. Overall sound level.....	92
5.2. Sound data.....	93

5.1 Overall sound level

The sound pressure level is based on the following conditions:

- 1 Distance of the unit from the measuring point: 1 meter from the unit's front surface; 1.5 meter from floor level.

Overall sound level measuring position

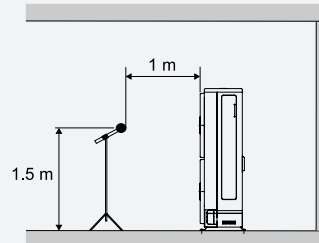

- 2 Power supply:
 - a. RAS-(4-6)FSVN2E: 1~ 230V 50Hz.
 - b. RAS-(4-6)FSNY2E: 3N~ 400V 50Hz.



NOTE

- *The sound data is measured in an anechoic chamber, so reflected sound should be taken into consideration when installing the unit.*

5.2 Sound data

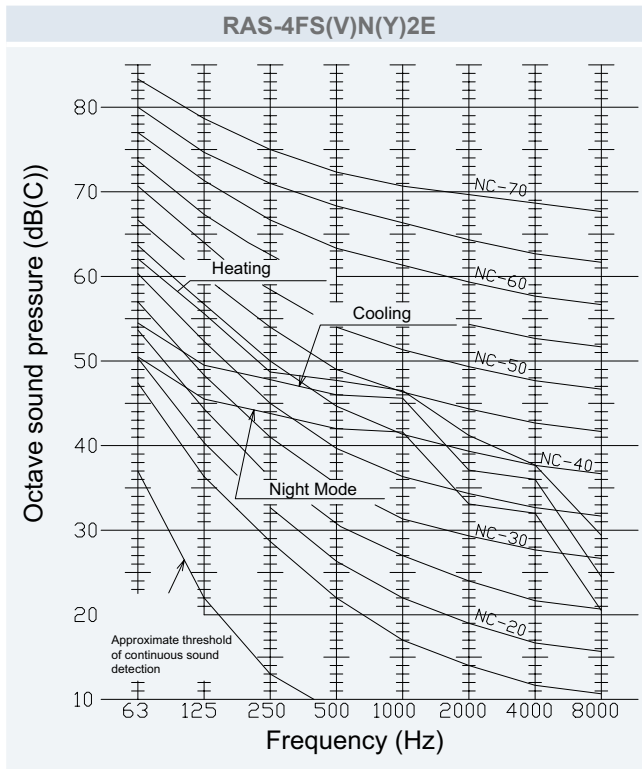

Sound pressure level: Cooling/Heating/Night mode;
49/51/45 dB(A)

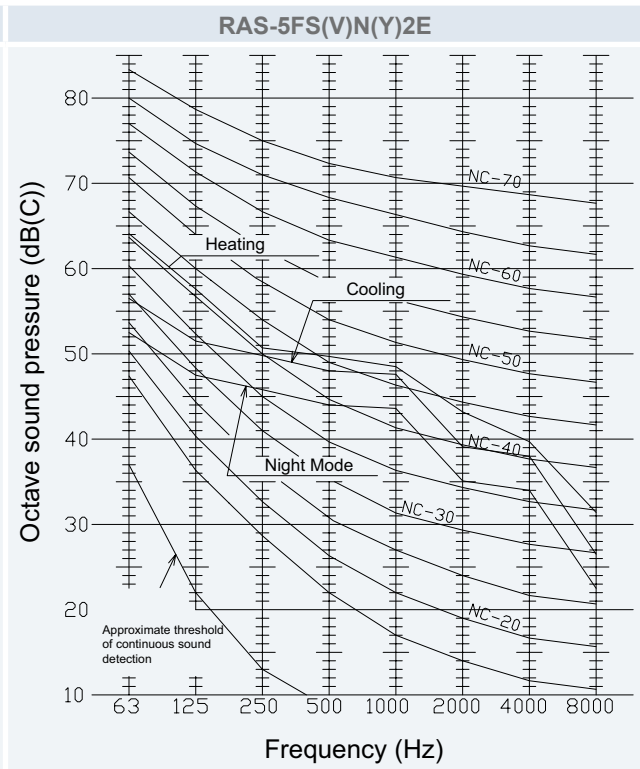

Sound pressure level: Cooling/Heating/Night mode;
51/53/47 dB(A)

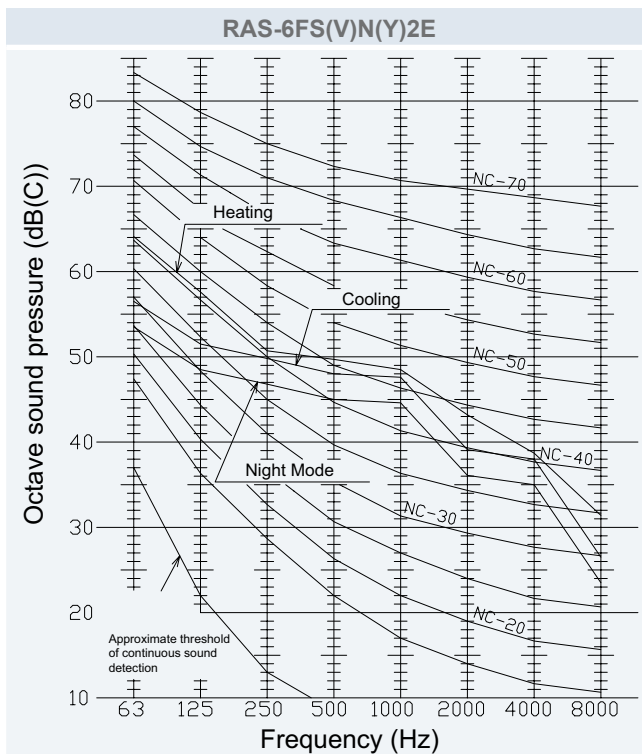

Sound pressure level: Cooling/Heating/Night mode;
51/53/48 dB(A)

5

6. Working range

Index

6.1. Working range	96
6.1.1. Power supply	96
6.1.2. Temperature range	96

6.1 Working range

6.1.1 Power supply

Operating voltage

Between 90 and 110% of the nominal voltage.

Voltage imbalance

Up to 3% of each phase, measured at the main terminal of the outdoor unit.

Initial voltage

Over 85% of the nominal voltage.

6.1.2 Temperature range

The temperature range is indicated in the following table:

		Cooling mode	Heating mode
Indoor air inlet temperature	Minimum	21 °C DB / 15 °C WB	15 °C DB
	Maximum	32 °C DB / 23 °C WB	27 °C DB
Outdoor air inlet temperature	Minimum	-5 °C DB	-20 °C WB (*)
	Maximum	46 °C DB	15 °C WB



NOTE

- **DB: dry bulb; WB: wet bulb.**
- **(*): (-15 – -20)°C WB, operation control range.**

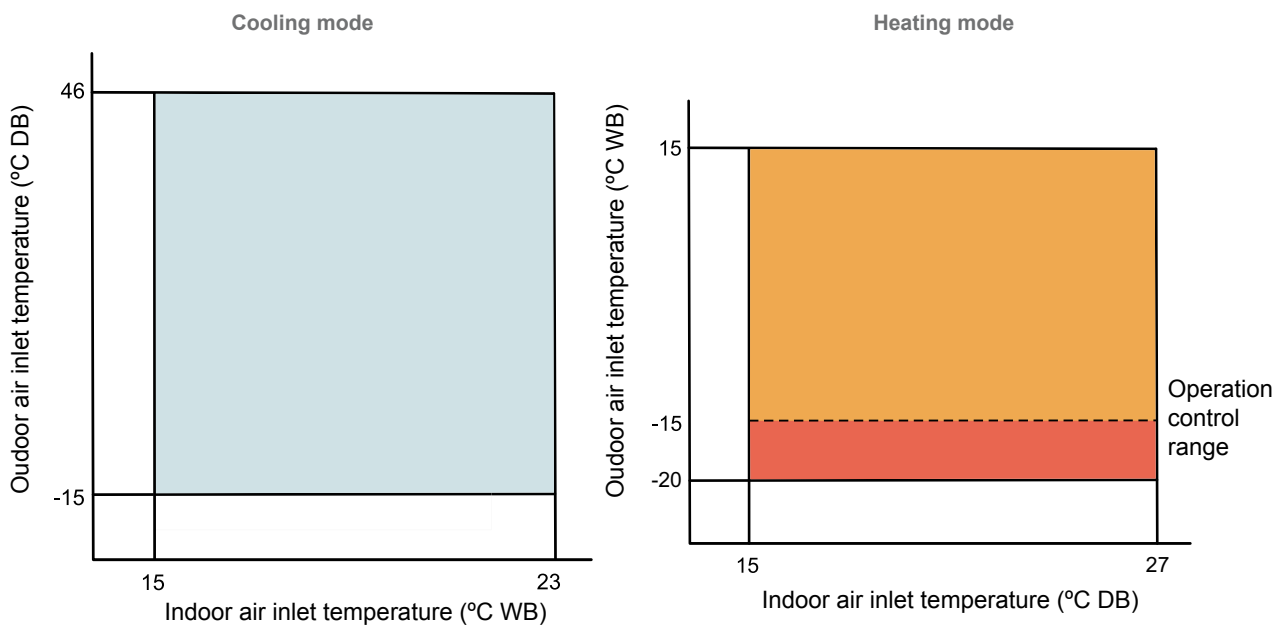

7. General dimensions

Index

7.1. Dimensions.....	98
7.2. Service space.....	99

7.1 Dimensions

RAS-(4-6)FS(V)N(Y)E

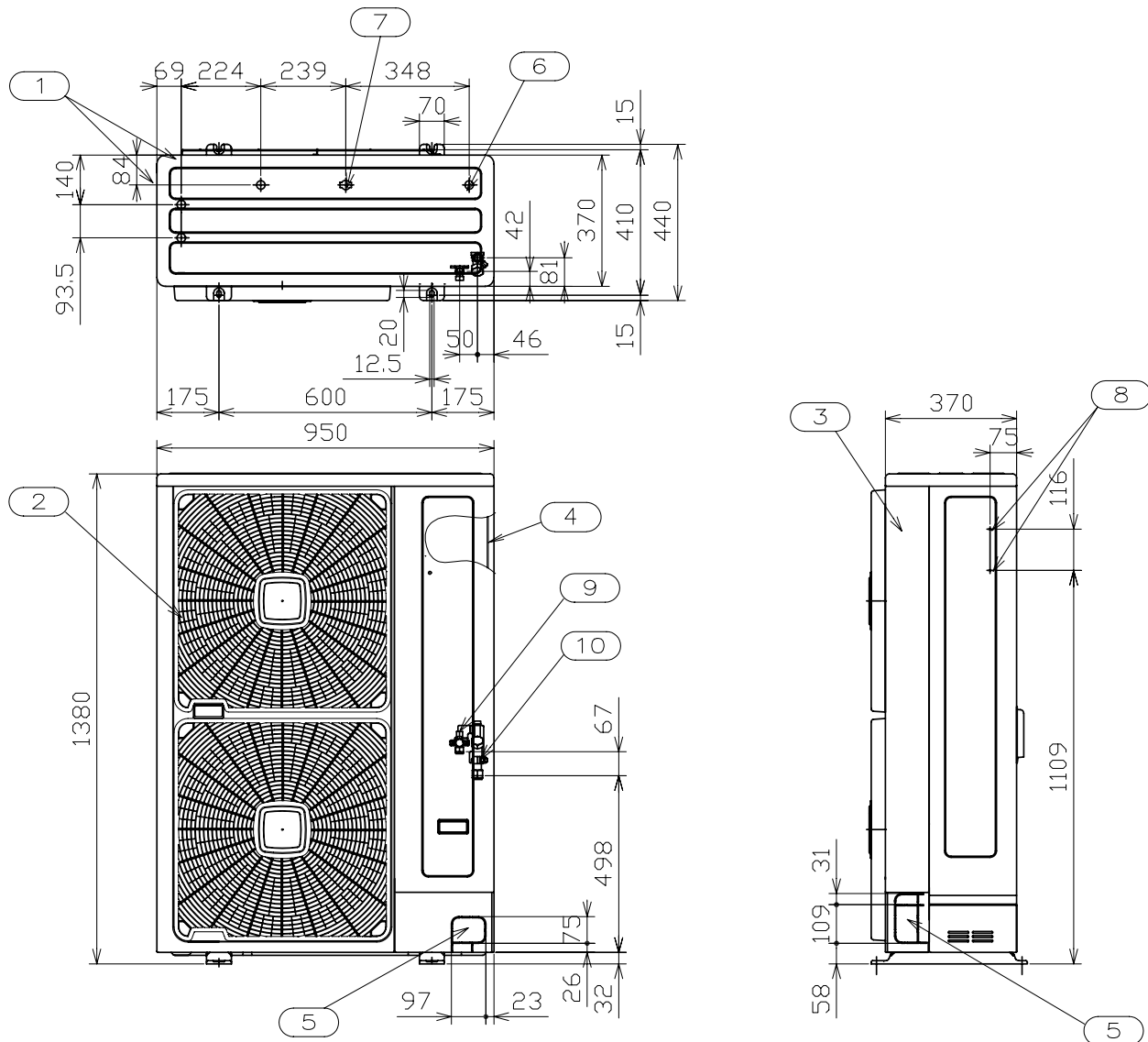

Units in mm.

N°	Part name	Remarks
1	Air inlet	—
2	Air outlet	—
3	Service cover	—
4	Electrical switch box	—
5	Holes for refrigerant piping and electrical wiring piping	—
6	Drain holes	3-Ø24
7	Drain holes	2-Ø26
8	Holes for fixing machine to wall	4-(M5)
9	Refrigerant liquid pipe	Flare nut: Ø9.53 (3/8")
10	Refrigerant gas pipe	Flare nut: Ø15.88 (5/8")



7.2 Service space

RAS-(4-6)FS(V)N(Y)E

Units in mm.

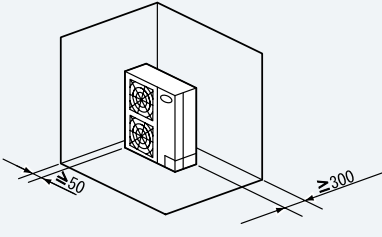
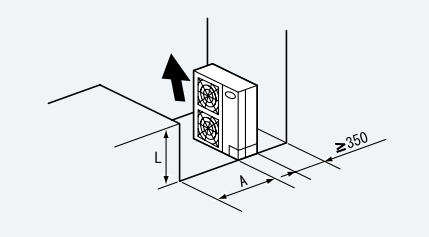
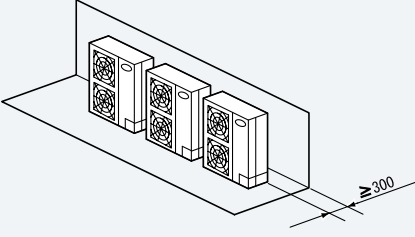
a) In case that upper side is open. (Single unit)	b) In case that upper side and either of the sides are open (front side obstacles exist). (Single unit)	c) Upper side is open. (Multiple unit)
		
<p>100 mm or more of the side space is acceptable on the service cover side</p>	<p>Allow 100mm of space between units. Leave open both right and left sides.</p>	<p>Be sure to use the fan direction guide. Leave open both right and left sides</p>



NOTE

- All measurements are in mm.
- The length A is shown in the following table:

L	A (mm)
$0 < L \leq 1/2H$	600 or greater
$1/2H < L \leq H$	1200 or greater

- Do not stack more than two units in height.
- For detailed information, please refer to SMXX0068.

8. Refrigerant cycle

Index

8.1. RAS-(4-6)FS(V)N(Y)2E	102
---------------------------------	-----

8.1 RAS-(4-6)FS(V)N(Y)2E

Example of twin combination:

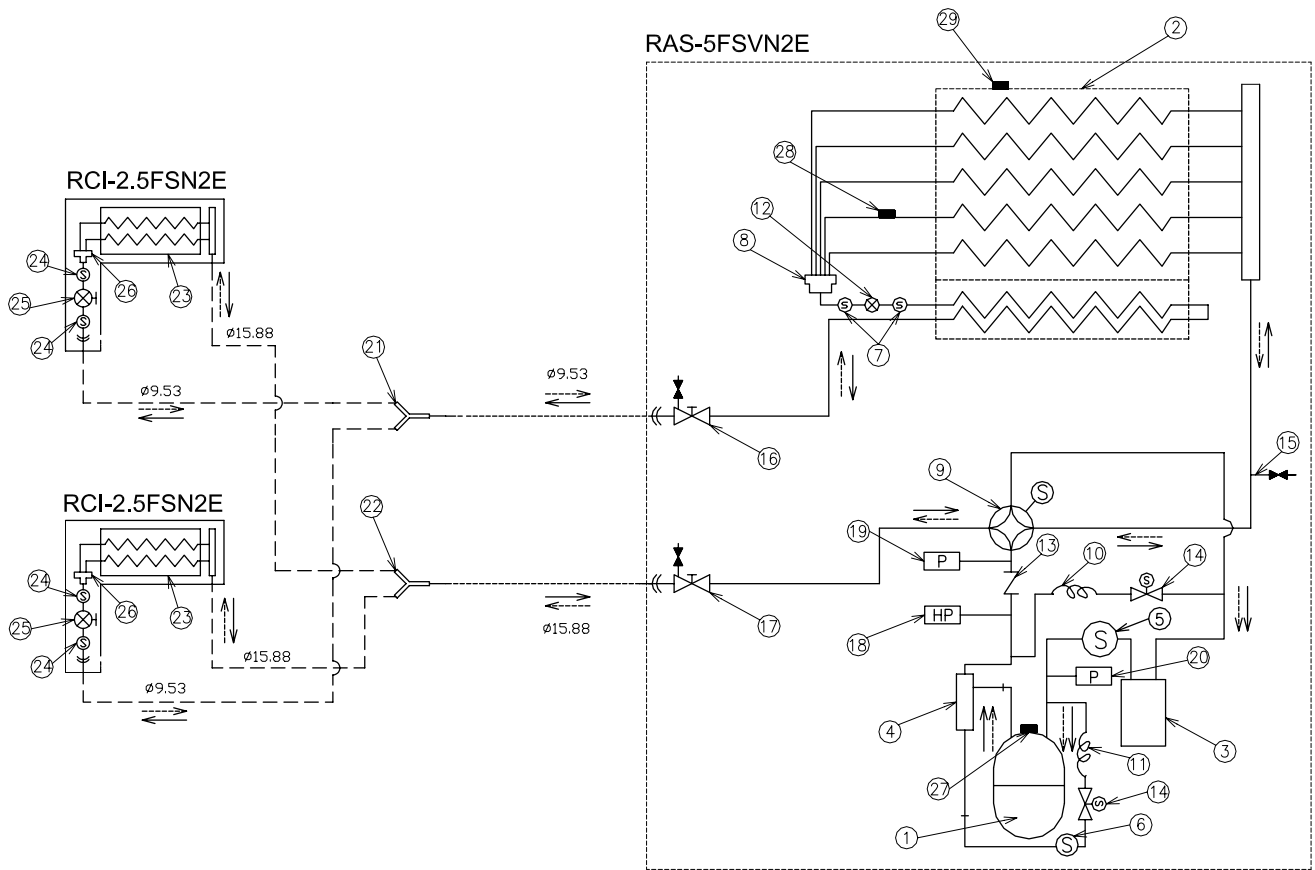

						R410A	4.15 MPa
Refrigerant flow for cooling	Refrigerant flow for heating	Installation refrigeration pipe	Connection by flare nut	Connection by flange	Connection by welding	Gas refrigerant	Leakage test pressure

No.	Part name	No.	Part name	No.	Part name
1	Compressor	11	Capillary tube	21	Branch pipe (liquid)
2	Outdoor unit heat exchanger	12	Micro computer control expansion valve	22	Branch pipe (gas)
3	Accumulator	13	Check valve	23	Indoor unit heat exchanger
4	Oil separator	14	Solenoid valve	24	Strainer
5	Strainer	15	Check joint	25	Expansion valve
6	Strainer	16	Stop valve for liquid line	26	Distributor
7	Strainer	17	Stop valve for gas line	27	Gas discharge thermistor
8	Distributor	18	High pressure switch for protection	28	Condenser pipe thermistor
9	Reversing valve	19	High pressure sensor	29	Ambient thermistor
10	Capillary tube	20	Low pressure sensor		-

9. Piping work and refrigerant charge

Index

9.1. Refrigerant piping selection.....	104
9.1.1. Piping size selection	104
9.1.2. Multi-kit or distributor selection	104
9.2. Refrigerant piping range.....	105
9.2.1. Refrigerant piping length	105
9.2.2. Refrigerant piping size.....	107
9.3. Piping materials.....	108
9.3.1. Copper pipes and sizes	108
9.3.2. Pipe connection	109
9.3.3. Insulation	109
9.4. Distribution method	110
9.5. Refrigerant charge amount.....	113
9.5.1. Refrigerant charge before shipment (W_0 (kg)).....	113
9.5.2. Additional refrigerant charge calculation method	113
9.5.3. Additional refrigerant charge calculation example	114
9.6. Caution in case of refrigerant leakage.....	115
9.6.1. Maximum permitted concentration of hydrofluorocarbon (HFC).....	115
9.6.2. Calculation of refrigerant concentration.....	115
9.6.3. Countermeasure for refrigerant leakage.....	115

9.1 Refrigerant piping selection

9.1.1 Piping size selection

Select the pipe size in line with the following instructions:

- 1 Between the outdoor unit and the branch pipe (multikit): select the same pipe connection size as for the outdoor unit.
- 2 Between the branch pipe (multikit) and the indoor unit: select the same pipe connection size as for the indoor unit.



CAUTION

- *Do not use refrigerant pipe sizes other than those indicated in this Technical Catalogue. The diameter of the refrigerant pipes depends directly on the outdoor unit capacity.*
- *If larger diameter gas refrigerant pipes are used, the circuit lubrication oil tends to separate from the gas carrying it. The compressor will be seriously damaged due to a lack of lubrication.*
- *If smaller diameter gas refrigerant pipes are used, the gas or liquid refrigerant will have serious difficulties in circulating. System performance will be affected. The compressor will run under more severe conditions than foreseen and will be damaged in a short space of time.*

9.1.2 Multi-kit or distributor selection



NOTE

- *Pipe connection size on outdoor units, indoor units and the multikit or distributor vary according to the system. For the specific information, please refer to Service Manual (SMXX0068).*
- *The sizes of the indoor and outdoor units could be different. Adjust the flare adapter (accessory) to the indoor pipe connection in these cases.*

9.2 Refrigerant piping range

9.2.1 Refrigerant piping length

The refrigerant piping between the indoor unit and the outdoor unit should be designed using the following chart.

Keep the design point within the area of the chart, which is showing the applicable height difference according to piping length

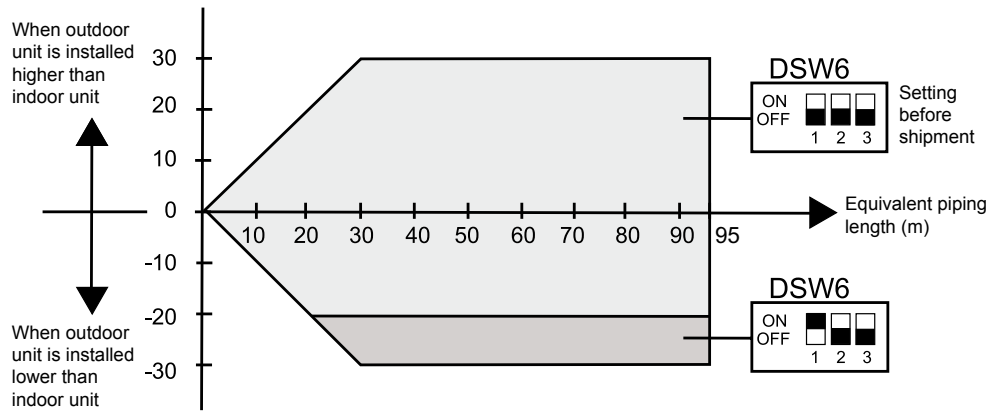

Piping system

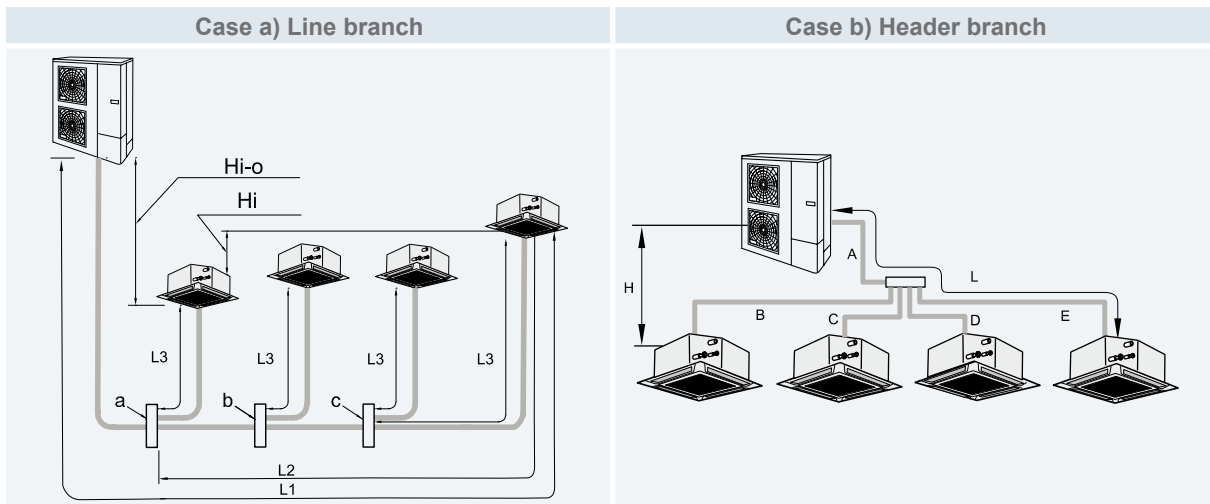

NOTE

L and H are the length and height indicated in the above chart. For multiple systems, the length is the distance between the outdoor unit and the farthest indoor unit.



NOTE

- The liquid piping and the gas piping must be of the same length and run along the same route.
- Multikits for multiple connections (optional accessory as system parts) must be used to install the branch pipe to the indoor unit.
- Install Multikits at the same horizontal level.

(m)

Item		(4-6) HP
Length from the outdoor unit to the furthest indoor unit (L1)	Actual length	≤ 75
	Equivalent length	≤ 95
Maximum length from the 1st multikit to the furthest indoor unit (L2)		≤ 40
Maximum height difference between outdoor and indoor unit (Hi-0)	If the outdoor unit is higher than the indoor unit	≤ 30
	If the outdoor unit is lower than the indoor unit	≤ 30
Maximum lift between each indoor unit (Hi)		≤ 15
Total piping length (L1+L3+L3+L3) (*)		≤ 125 (4HP)
		≤ 135 (5, 6HP)

Choice of each multikit	Mark	a,b,c
	Multikit	E-102SN



NOTE

(): L3 length has to be lower than 10 m.*

9.2.2 Refrigerant piping size

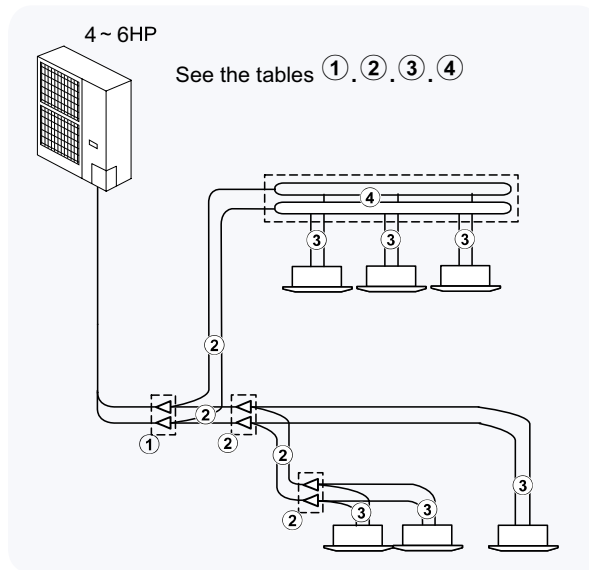

◆ **Table ①: Outdoor unit to first multi-kit**

Outdoor unit	Pipe size (Ø mm)		Multi-kit
	Gas	Liquid	
RAS-(4-6)FS(V)N(Y)2E	15.88	9.53	E-102SN2

◆ **Table ②: First multi-kit to last branch**

Total indoor units capacity	Pipe size (Ø mm)		Multi-kit
	Gas	Liquid	
≤2.3HP	12.7	6.35	E-102SN2
2.3≤HP<7.0	15.88	9.53	E-102SN2

◆ **Table ③: Multi-kit to indoor unit**

Indoor unit capacity (HP)	Pipe size (Ø mm)		Maximum liquid piping length
	Gas	Liquid	
0.8 to 1.5	12.70	6.35 (*)	10 m
2.0	15.88	6.35 (*)	10 m
2.5 to 6.0	15.88	9.53	10 m



NOTE

- (*): The pipe size must be the same size of the piping connection hole of the I.U.
- The pipe shown in the above table is applicable for both: the line branch and the header branch.

◆ **Table ④: Header branch**

Applicable model	Pipe size (Ø mm)		Multi-kit model	
	Gas	Liquid	2~4 Branches	2~8 Branches
RAS-(4-6)FS(V)N(Y)2E	15.88	9.53	MH-84AN	MH-108AN

9.3 Piping materials

9.3.1 Copper pipes and sizes

- 1 Prepare locally-supplied copper pipes.
- 2 Select the pipe size of a suitable thickness and material. Use the table below to select the required piping.

Nominal diameter		Thickness (mm)	Copper type
(mm)	(in.)		
Ø6.35	1/4	0.80	Roll
Ø9.53	3/8	0.80	Roll
Ø12.70	1/2	0.80	Pipe/Roll
Ø15.88	5/8	1.00	Roll



NOTE

If copper pipe is used for piping bigger than Ø19.05, flaring work can not be performed. If necessary, use a joint adapter.

- 3 Select clean copper pipes. Make sure there is no dust and moisture inside. Blow the inside of the pipes through with oxygen-free nitrogen to remove any dust and foreign materials before connecting pipes.
- 4 After connecting the refrigerant piping, seal the open space between the knockout hole and refrigerant pipes by using insulation material as shown below:

A. Insulation.

B. Field-supplied refrigeration piping.

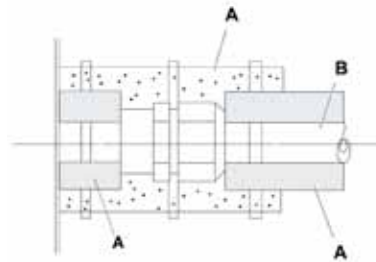

NOTE

Do not use saws, grindstone or other tools which might create copper dust.

When cutting pipes, secure the part to be soldered as shown in chapter 2 of the Service Manual (SMxx0064).

- ***Strictly follow national or local regulations regarding occupational health and safety.***
- ***Wear appropriate means of protection during cutting or brazing operations and installation (gloves, eye protection, etc).***

9.3.2 Pipe connection

Fix the connecting pipe as shown in the figure below. Use the insulation attached to the indoor unit.

- A. Use the flare nut of the indoor unit.
- B. Insulate this part with the insulation material supplied.
- C. Fix this part with the bracket supplied or with tape.
- D. Refrigerant piping in the installation.
- E. Field-supplied insulation.
- F. Brazing.
- G. Make flares after attaching flare nut to the connecting pipe in the Multikit package.
- H. Insulation attached to indoor unit.
- I. Indoor unit.

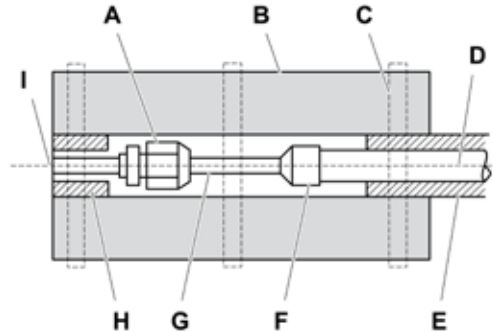

NOTE

- A system with no moisture or oil contamination will give maximum performance and life-cycle as compared with a poorly prepared system. Take particular care to ensure that all copper piping is clean and dry internally.
- To ensure this, blow oxygen free nitrogen through the pipes.



CAUTION

- Cap the end of the pipe when the pipe is to be inserted through a hole.
- Do not place pipes directly on the ground without a cap or vinyl tape covering the end, as it shown in the figure.

Right

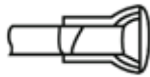

Wrong



- If piping installation cannot be completed until the following day or longer, solder the ends of the piping to close them and load with oxygen-free nitrogen using an access device such as a Schrader valve to avoid moisture and contamination by extraneous particles.
- Do not use insulation material containing NH₃ as it can damage the copper piping material and may be a source of future leakage.

9.3.3 Insulation

Attach insulation package with the Multikit to each branch using vinyl tape. Also attach insulation to field-supplied piping to prevent capacity decrease due to ambient air conditions and dewing on pipe surface caused by low pressure.



NOTE

When polyethylene foam is applied, a thickness of 10 mm for the liquid piping and from 15 mm to 20 mm for the gas piping is recommended.



CAUTION

Perform insulation work after the surface temperature decreases to the room temperature, If not, the insulation material may melt. If the ends of the piping system are open after finishing the installation work, securely attach caps or vinyl bags to the ends of the piping to prevent moisture or dust entering.

9.4 Distribution method

With line distribution method, it is possible to make the first or the second main pipe distribution within the third branch. And do not make the main pipe distribution, at or after the fourth branch.

◆ Branch method

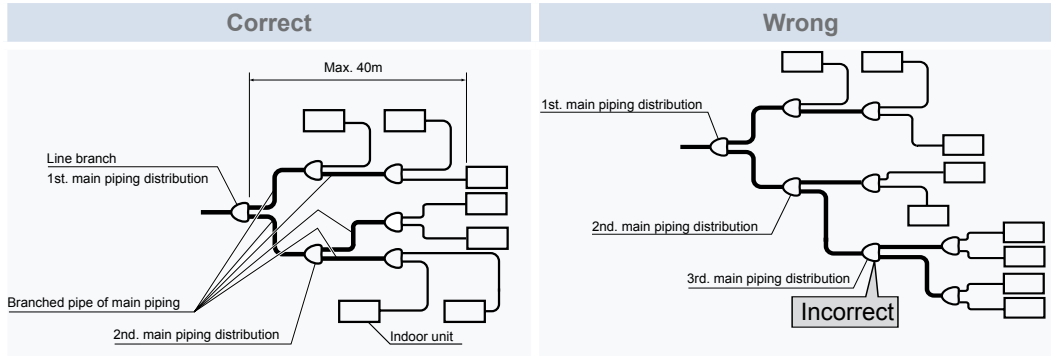

◆ Branch method in 3rd multi-kit

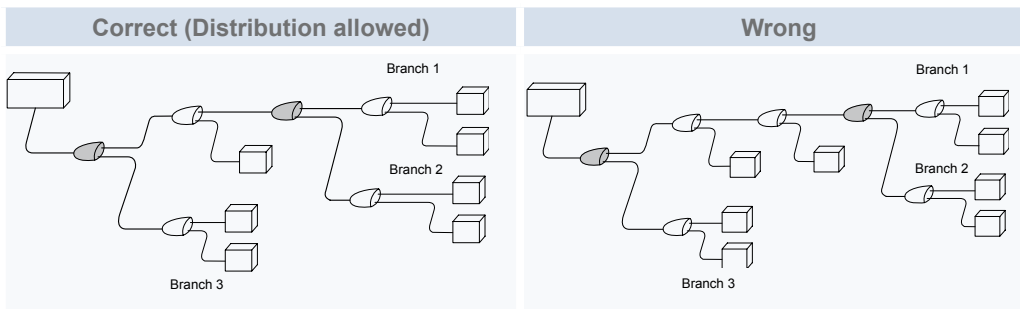

(Main pipe distribution: Distribution from one multi-kit to two multi-kits)

◆ Installation position

Horizontal installation

Locate the branch pipes on the same horizontal plane. (Inclination within 30°)

Make the straight length a minimum of 0.5m after the vertical bend.

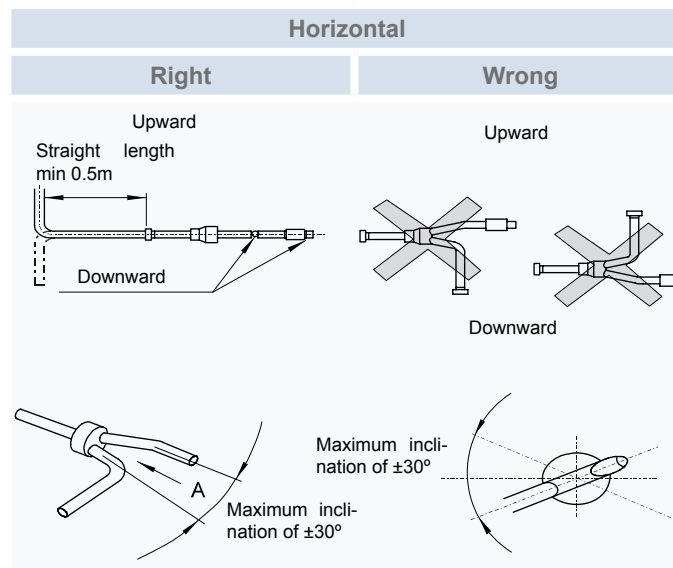

Vertical installation

Straight length of the pipe connection on the outdoor unit side is made as follows:

- * The collective pipe connection part is installed upward, the straight length must be min. 0.5m.
- * The collective pipe connection part is installed downward, the straight length must be min.0.3m.

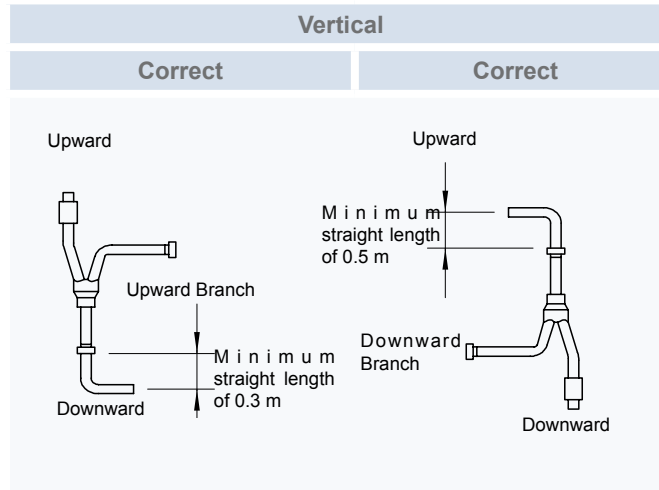

◆ Header distribution

Branch method

Do not connect two header branches consecutively.

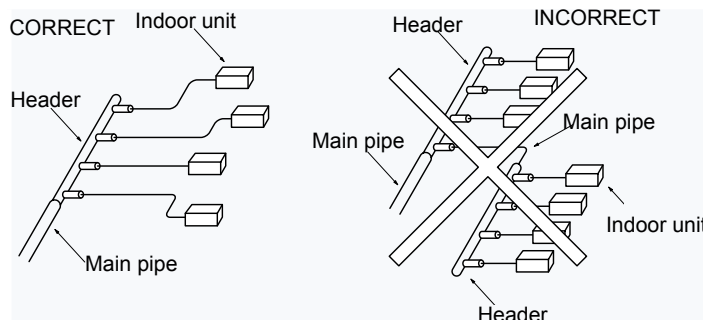

Installation position

Perform to install horizontally always(Ex.: In case of model MH-108AN)

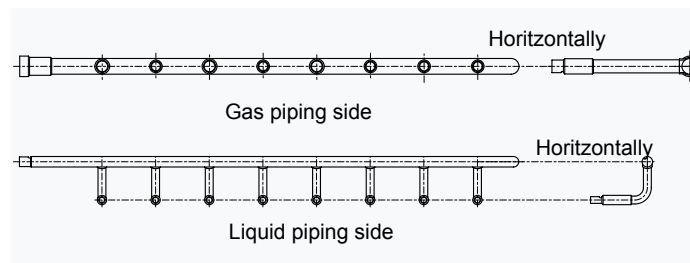

⚠ CAUTION

Seal the end of branch pipes which are not connected, by brazing factory supplied closing pipes.

Combination branch

It is possible to connect the header to the second branch, when the first branch is also the line branch.

Do not connect a line branch to a header branch.

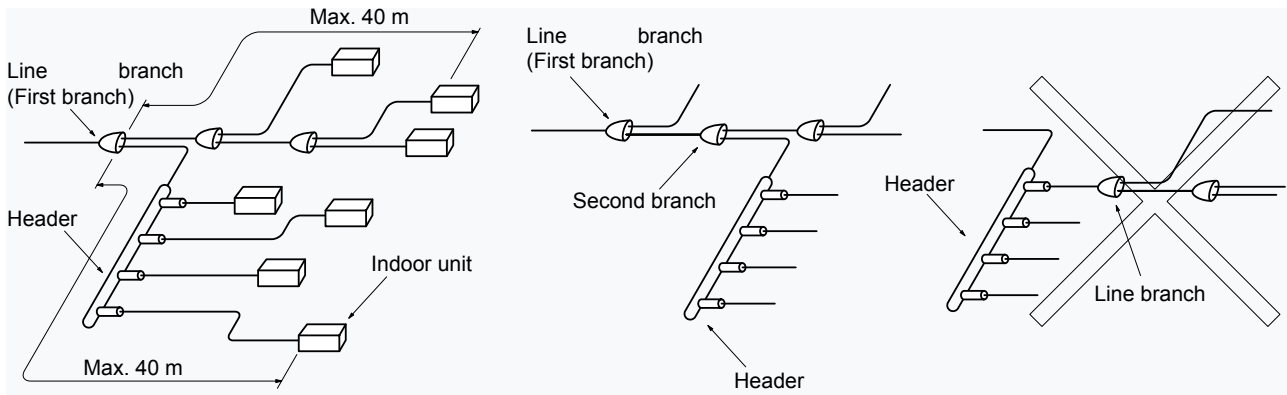

9.5 Refrigerant charge amount

Although refrigerant has been charged into this unit, additional refrigerant charge is required according to piping length.

- The additional refrigerant quantity should be determined and charged into the system according to the following procedure.
- Record the additional refrigerant quantity in order to facilitate maintenance and servicing activities.

9.5.1 Refrigerant charge before shipment (W_0 (kg))

W_0 is the outdoor unit refrigerant charge before shipment (Factory charge), and it's shown in the following table:

Model	Refrigerant charge before shipment (W_0 (kg))
RAS-4FS(V)N(Y)2E	3.6
RAS-5FS(V)N(Y)2E	
RAS-6FS(V)N(Y)2E	



CAUTION

- **When charging refrigerant, measure the amount precisely.**
- **Overcharging or undercharging of refrigerant may cause compressor problems.**

9.5.2 Additional refrigerant charge calculation method

Calculate the additional refrigerant charge amount (Additional charge) according to the following steps:

◆ Step 1: Additional refrigerant charge calculation for liquid piping (W_1 (kg))

The additional refrigerant charge must be calculated by multiplying the total piping length of each diameter per its calculation factor according to the following table. The result is the additional refrigerant charge for liquid piping.

Pipe size (mm)	Additional refrigerant charge factor (kg/m)
Ø9.53	x 0.05
Ø6.35	x 0.02

◆ Step 2: Charging work

Charge refrigerant (R410A) into the system according to the instructions in the Service Manual.

◆ Step 3: Total refrigerant charge of the system (W_{TOT} (kg))

The total refrigerant charge (Total charge) of this system is calculated by the following formula:

$$W_{TOT} = W + W_0$$

System example (W_{TOT}) = + = kg

W_0 is the outdoor unit refrigerant charge before shipment explained before, and it's shown in its specific table.

Finally, record the refrigerant charge quantity in the F-Gas label order to facilitate maintenance and servicing activities.

(EN) This equipment contains fluorinated greenhouse gases covered by the Kyoto protocol.	
(ES) Este equipo contiene gases fluorados de efecto invernadero contemplados en el protocolo de Kyoto.	
(DE) Diese Anlage enthält im Rahmen des Kyoto-Protokolls genannte, fluorierte Treibhausgase.	
(FR) Cet appareil contient des gaz fluorés à effet de serre visés par le protocole de Kyoto.	
(IT) Questa apparecchiatura contiene gas fluorurati ad effetto serra che rientrano nel protocollo di Kyoto.	
(PT) Este equipamento contém gases fluorados que provocam efeito de estufa, segundo o protocolo de Kyoto.	
(DA) Dette udstyr indeholder fluorholdige drivhusgasser, der er omfattet af Kyoto-protokollen.	
(NL) Deze apparatuur bevat gefluoreerde broeikasgassen die vallen onder het protocol van Kyoto.	
(SV) Denna anläggning innehåller fluorhaltiga växthusgaser som regleras av Kyoto-protokollet.	
(EL) Ο παρών εξοπλισμός περιέχει φθοροειδή αέρια θερμοκηπίου τα οποία αναφέρονται στο πρωτόκολλο του Κιότο.	
Do not vent R410A into the atmosphere.	Não efectue a ventilação do R410A para a atmosfera.
No discharge of R410A in to atmosphere.	Sigillate R410A usj atmosfæren.
Lassen de R410A aldrig bli ledt udvendt.	Lad gasen R410A ontgæppe i de atmosfæren.
Ne laissez pas le R410A se répandre dans l'atmosphère.	Sigilló lite ut R410A i atmosfæren.
Non scaricare R410A nell'atmosfera.	Myg EXLUÐRIGVETE TO R410A OTTY OTJÓOPAPPE.
REFRIGERANT INFORMATION - INFORMACIÓN SOBRE EL REFRIGERANTE - KÜHLMITTELINFORMATION	
INFORMATION CONCERNANT LE FLUIDE FRIGORIFÈRE - INFORMAZIONI RELATIVE AL REFRIGERANTE	
INFORMAÇÕES SOBRE O REFRIGERANTE - OPPLYSNINGER OM KØLEMITTEL - INFORMATION OVER KØLESTOFF	
KYLNINGSMIDDELINFORMATION - ΣΤΟΙΧΕΙΑ ΨΥΚΤΙΚΟΥ ΜΕΣΟΥ	
Refrigerant - Refrigerante - Kühlmittel - Fluide frigorigène - Kältemittel - Kølestof - Kyllings - Μέσο	R410A
Factory Charge - Carga de fábrica - Werksbefüllung - Charge en usine	<input type="text"/>
(Fabrikas / Fabrikk) / (Fábrica / Fabrik) / (Fabrik / Fabrik) / (Fabrik / Fabrik)	kg
Quantity at shipment - Cantidad en envío - Menge beim Verschiffen - In fabrikas / (Fabrikas / Fabrik) / (Fabrik / Fabrik)	<input type="text"/>
Παράδοση από τον κατασκευαστή - Entrega desde el fabricante - In fabrikas / (Fabrikas / Fabrik) / (Fabrik / Fabrik)	kg
Additional Charge - Carga adicional - Zusätzliche Füllmenge - Charge supplémentaire	<input type="text"/>
Carica aggiuntiva - Carga adicional - Ekstra påfylling - Extra vulling - I tillegg påfylling	kg
Πρόσθετη φόρτιση	<input type="text"/>
Total Charge - Carga Total - Gesamtfüllmenge - Charge totale - Carica totale	<input type="text"/>
Carga total - Samlet påfylling - Totale vulling - Total påfylling - Zovollte mængde	kg

9.5.3 Additional refrigerant charge calculation example

Example of quadruple system for RAS-6FS(V)N(Y)2E

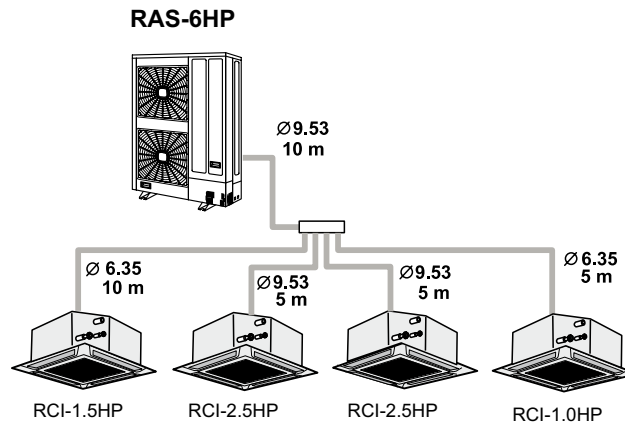

◆ Step 1: Additional refrigerant charge calculation for liquid piping (W_1 (kg))

Calculate the additional refrigerant charge for the liquid piping as indicated below. Check the example and fill in the following table.

Pipe size (mm)	Total Piping length (m)	Additional refrigerant charge (kg/m)	Subtotal (kg)
Ø9.53	10 + 5 + 5	x 0.05	1.0
Ø6.35	10 + 5	x 0.02	0.3
TOTAL			$W_1 = 1.3$

◆ Step 2: Total refrigerant charge of the system (W_{TOT} (kg))

The total refrigerant charge of this system is calculated by the following formula:

$$W_{TOT} = W_0 + W_1$$

Refrigerant charge before shipment (W_0) = 3.6 kg (Refer to its specific table)

$$W_{TOT} = 3.6 + 1.3 = 4.9 \text{ kg}$$

9.6 Caution in case of refrigerant leakage

The installers and those responsible for drafting the specifications are obliged to comply with local safety codes and regulations in the case of refrigerant leakage.

9.6.1 Maximum permitted concentration of hydrofluorocarbon (HFC)

The refrigerant R410A, charged in the UTOPIA series system, is an incombustible and non-toxic gas. However, if leakage occurs and gas fills a room, it may cause suffocation. The maximum permissible concentration of HFC gas, R410A in air is 0.44 kg/m³, according to EN378-1.

The room must have the following characteristics should there be a gas refrigerant leak:

Therefore, some effective measure must be taken to lower the R410A concentration in air below 0.44 kg/m³, in case of leakage.

9.6.2 Calculation of refrigerant concentration

The room must have the following characteristics should there be a gas refrigerant leak:

- 1 Calculate the total quantity of refrigerant R (kg) charged in the system by connecting all the indoor units in the rooms to be air-conditioned.
- 2 Calculate the room volume V (m³) of each room.
- 3 Calculate the refrigerant concentration C (kg/m³) of the room according to the following equation:

$$C = R / V$$

R: Total quantity of refrigerant charged (kg).

V: Room volume (m³).

C: Refrigerant concentration (≤ 0.44 kg/m³ for R410A).

9.6.3 Countermeasure for refrigerant leakage

The facility must have the following features in case of a refrigerant leakage occurs:

- 1 Provide a shutterless opening which will allow fresh air to circulate into the room.
- 2 Provide a doorless opening of 0.15% or more size to the floor area.
- 3 There must be a ventilator fan connected to a gas leak detector, with a ventilator capacity of 0.4 m³/min or higher per Japanese refrigeration ton (= compressor displacement volume / 5.7 m³/h) of the air conditioning system using the refrigerant.

Model	Tonnes
RAS-4FS(V)N(Y)2E	1.84
RAS-5FS(V)N(Y)2E	2.07
RAS-6FS(V)N(Y)2E	2.30

- 4 Pay a special attention to the place, such as a basement, etc., where refrigerant can stay, since refrigerant is heavier than air.

◆ **Example of application**

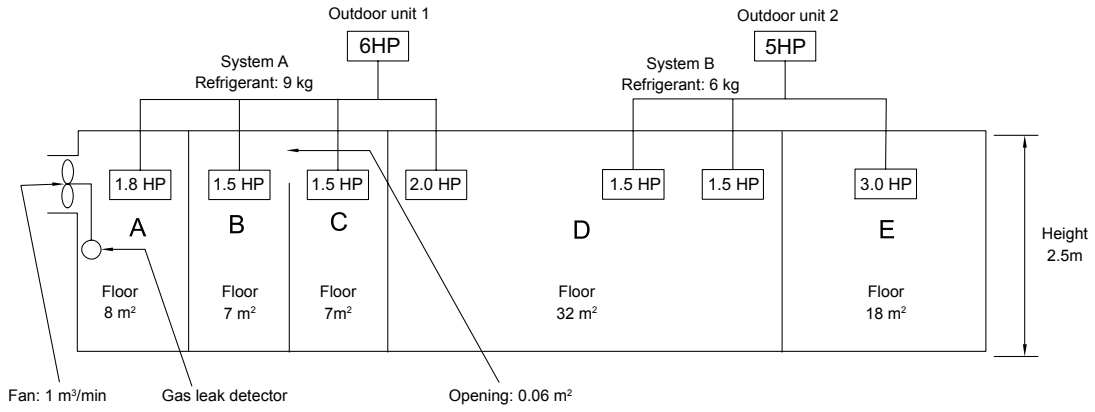

Room	R (kg)	V (m ³)	C (kg/m ³)	Countermeasure
A	9	20	0.45	1 m ³ /min fan linked with gas leak detector
B	9	17.5	0.51	0.06 m ² aprox. opening
C	9	17.5	0.51	0.06 m ² aprox. opening
B+C	9	35	0.26	-
D	16	80	0.20	-
E	7	45	0.16	-

10. Electrical wiring

Index

10.1. General information.....	118
10.1.1. General notes.....	118
10.1.2. General verifications.....	118
10.2. Setting of DIP switches and RSW switches	120
10.3. Common wiring	122
10.3.1. Electrical wiring between outdoor and indoor unit.....	122
10.3.2. Wiring size	123
10.4. H-LINK II system	124
10.4.1. Application.....	124
10.4.2. Features	124
10.4.3. Specifications	124
10.4.4. DIP switch setting for multiple H-LINK system	125
10.4.5. Examples of the system of connection between H-LINK and H-LINK II units	126
10.4.6. Examples of H-LINK II system.....	127

10.1 General information

10.1.1 General notes



CAUTION

- *Before any electrical wiring work or regular inspections, switch off the main power supply switches of the indoor and outdoor units. Wait three minutes before starting installation or maintenance work.*
- *Make sure that the indoor and outdoor fans are completely stopped before starting work on the electrical wiring or regular inspections.*
- *Protect cables, drain hose, electric parts, etc. from rodents and insects; otherwise these might damage unprotected components and, in the worst case, cause a fire.*
- *Do not allow cables to come into contact with the refrigerant pipes, metal edges, printed circuit boards (PCB) or the electric parts inside the unit; the cables may be damaged and, in the worst case, cause a fire.*
- *Firmly secure the cables inside the indoor unit with plastic flanges.*
- *In the case that a conduit tube for field-wiring is not used, fix rubber bushes with adhesive on the panel.*



DANGER

- *Use an earth leakage breaker with medium sensitivity, and an activation speed of 0.1 sec or less. If this is not fitted, there is a risk of electric shock and/or fire.*
- *Install an earth leakage breaker, fuse and circuit breaker for each outdoor unit power line. Not fitting it may cause an electric shock or fire.*

10.1.2 General verifications

- 1 Make sure the electric components supplied by the installer (main power switches, circuit breakers, wires, connectors and connection terminals) have been selected correctly in line with the electrical data given.
 - a. The electricity supplied to the unit should be via an exclusive power control switch and protective circuit breaker, certified and installed in accordance with local or national safety regulations.
 - b. The electricity supplied for the outdoor and indoor units should be separated. Connect the voltage supply wiring for each group of indoor units to the same outdoor unit
- 2 Check that the supply voltage is between 90 and 110% of the rated voltage. Where the voltage capacity is too low, it will not be possible to start the system due to the drop in voltage.
- 3 During the preliminary preparation work of the electricity supply line for the unit, the provisions in local and national legislation must never be violated.
- 4 Check that the earth cable is correctly connected.



DANGER

- *Never connect the earth cable to the refrigerant pipes. The gas in the pipes could cause a fire.*
- *Do not connect the earth cable to the lighting arrest system. The electrical potential of earth would increase abnormally.*

Electromagnetic compatibility

Following the Council Directive 2004/108/EC (89/336/EEC), relating to electromagnetic compatibility, next table indicates: Maximum permissible system impedance Z_{max} at the interface point of the user's supply, in accordance with EN61000-3-11

MODEL	Z_{max} (Ω)
RAS-4FSVN2E	0.29
RAS-5FSVN2E	0.29
RAS-6FSVN2E	0.29
RAS-4FSNY2E	—
RAS-5FSNY2E	—
RAS-6FSNY2E	—

Harmonics

Harmonics situation of each model regarding IEC 61000-3-2 and IEC 61000-3-12 is as follows:

MODELS SITUATION REGARDING IEC 61000-3-2 and IEC 61000-3-12	MODEL	Ssc "xx" (KVA)
Equipment complying with IEC 61000-3-2 (professional use)	RAS-4FSNY2E	—
	RAS-5FSNY2E	—
	RAS-6FSNY2E	—
Equipment complying with IEC 61000-3-12	RAS-4FSVN2E	—
	RAS-5FSVN2E	—
	RAS-6FSVN2E	—

10.2 Setting of DIP switches and RSW switches



CAUTION

Before changing the settings of the DIP switches, the voltage supply should be disconnected. Otherwise, the new settings will not be valid. Only the DIP DSW1 and DSW2 and DSW4 switches can be set while the voltage supply is connected.



NOTE

- The mark “■” indicates the position of dips switches.
- No mark “■” indicates pin position is not affecting.
- The figures show the settings before shipment or after selection.
- For detailed information, please refer to the SMXX0068.

Number and position of DIP Switches for Outdoor Units

The PCB in the outdoor units operates with 6 types of DIP switches, 6 cut-off switches and 3 types of push-switches.

Position of DIP switches

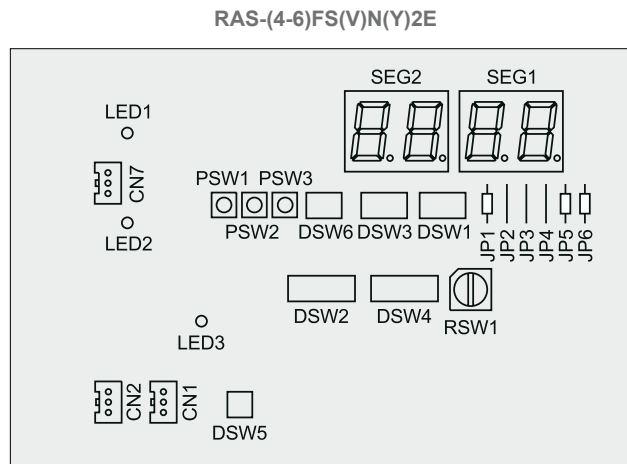

◆ DSW1: For Test Run

Setting before shipment

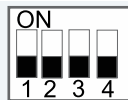

NOTE

With the DSW4 switch, the unit starts or stops after 10 to 20 seconds of the switch being activated.

◆ DSW2: Optional function setting

Setting before shipment
(RAS-(4-6)FS(V)N(Y)2E)



Pin N°	Setting Item
1	OFF (Fixed)
2	High-pressure control based on R407C piping
3	OFF (Fixed)
4	OFF (Fixed)
5	Function selection setting (Selection is set by PSW)
6	External input/output selection (Selection is set by PSW)

◆ **DSW3: Capacity**

	RAS-4FSVN2E	RAS-5FSVN2E	RAS-6FSVN2E
No setting is required			

◆ **Refrigerant cycle no. setting**

DSW4

Setting position
(Setting for the ten digit).

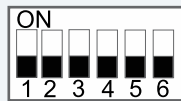

RSW1

Setting position.
(Setting for the last digit).



◆ **DSW5: Transmission setting of end terminal resistance**

Setting before shipment



◆ **DSW6: Other settings**

Setting before shipment



Indoor units are higher than outdoor units
(h ≥ 20m)



Fine-tuning of heating capacity



10.3 Common wiring

10.3.1 Electrical wiring between outdoor and indoor unit

Connect the electrical wires between the indoor unit and the outdoor unit as show in the figure.

- When installing the electrical wiring, follow local codes and regulations.
- The refrigerant piping and the control wiring are connected to the units in the same refrigerant cycle.
- Use twist pair wire (more than 0.75 mm²) for operation wiring between the outdoor unit and indoor unit, and operation wiring between indoor unit and indoor unit.
- Use a 2-core wire for the operating line (do not use wire with more than 3 cores).
- Use shielded wires for intermediate wiring to protect the units from noise interference at lengths of less than 300 m. The size must comply with local code.
- Open a hole near the connection hole of power source wiring when multiple outdoor units are connected from a single power source line.
- The recommended circuit-breaker sizes are shown in the table of electrical data and recommended wiring and breaker sizes / 1 O.U.
- In the case that a conduit tube for field-wiring is not used, fix rubber bushes with adhesive on the panel.
- All field wiring and equipment must comply with local and international codes.
- H-LINK twist pair shielded cable must be grounded in the outdoor unit side.



NOTE

- **Take care with the connection of the operating line. Incorrect connection may cause a failure of the PCB.**

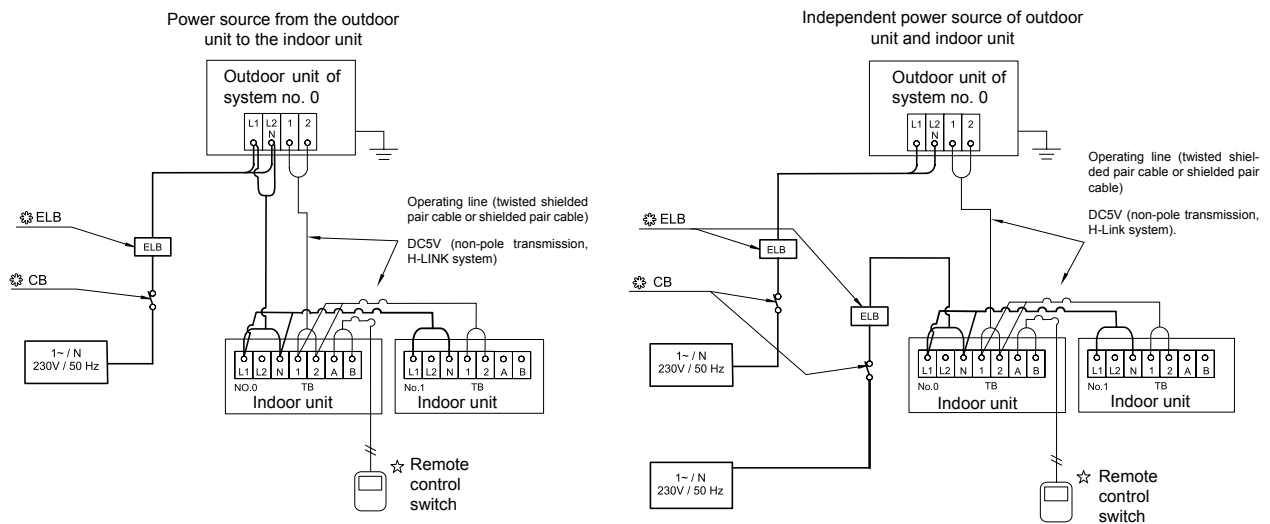

- TB Terminal board
- CB Circuit breaker
- ELB Earth leakage breaker
- Field wiring
- ⊕ Field-supplied
- ☆ Optional accessory

10.3.2 Wiring size

◆ Connection wiring

Recommended minimum sizes for field provided wires:

Model	Power supply	Maximum current (A)	Power supply cable size EN60 335-1	Transmitting cable size EN60 335-1
All indoor units	1~ 230V 50Hz	5.0	0.75 mm ²	0.75 mm ²
RAS-4FSVN2E		26.0	6.0 mm ²	
RAS-5FSVN2E		26.0	6.0 mm ²	
RAS-6FSVN2E		26.0	6.0 mm ²	
RAS-4FSNY2E	3N~ 400V 50Hz	13.0	4.0 mm ²	
RAS-5FSNY2E		13.0	4.0 mm ²	
RAS-6FSNY2E		13.0	4.0 mm ²	



NOTE

- **Follow local codes and regulation when selecting field wires, circuit breakers and earth leakage breakers.**
- **Use the wires which are not lighter than the ordinary polychloroprene sheathers flexible cord (code designation H05RN-F).**

◆ Main switch protection

Select the main switches according to the following table:

Model	Power supply	Maximum current (A)	CB (A)	ELB (No. of poles/A/mA)
All indoor units	1~ 230V 50Hz	5.0	6	2/40/30
RAS-4FSVN2E		26.0	32	
RAS-5FSVN2E		26.0	32	
RAS-6FSVN2E		26.0	32	
RAS-4FSNY2E	3N~ 400V 50Hz	13.0	20	4/40/30
RAS-5FSNY2E		13.0	20	
RAS-6FSNY2E		13.0	20	



NOTE

- **CB: Circuit breaker.**
- **ELB: Earth leakage breaker.**

10.4 H-LINK II system

The H-LINK II is the wiring connection system between units.

The H-LINK II wiring system only needs:

- Two transmission wires connecting each indoor and outdoor unit for a total of 64 refrigerant cycles.
- Connection wiring for all indoor and outdoor units in series.

10.4.1 Application

The H-LINK II system can be applied to the following models:

Indoor Unit	Outdoor Unit
System Free	RAS-(4-6)FS(V)N(Y)2E
RCI	
RCIM	
RCD	
RPI	
RPIM	
RPK	
RPF	
RPFI	
RPC	



CAUTION

The H-LINK II system cannot be applied to the models with the old cycle, nor to units with an old transmission.

10.4.2 Features

- The total wiring length is considerably reduced compared to traditional connections.
- Only one connection is required for the wiring between the indoor and outdoor units.
- The wiring connection of the complementary central control devices is easy.



NOTE

CSNET WEB is centralized control system which allows the installation to be controlled remotely. It can be connected at any point of the local corporate network, or even via the Internet.

10.4.3 Specifications

- Transmission cable: 2-wire.
- Polarity of transmission cable: non-polar wire.
- Maximum number of indoor units that can be connected: 4 units per cycle and 160 units per H-LINK II system.
- Maximum wiring length: total 1000 m (including CSNET WEB).
- It is possible to increase the maximum wiring length up to 5000 m by using up to four PSC-5HR units.
- Recommended cable: shielded twisted pair cable, over 0.75 mm² (Equivalent to KPEV-S).
- Voltage: 5 V DC.

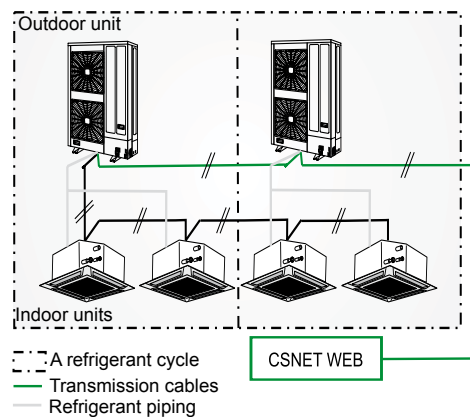

CAUTION

For the H-LINK II system must use twisted shielded pair cable or shielded pair cable.

10.4.4 DIP switch setting for multiple H-LINK system

The DIP switches of all the outdoor and indoor units have to be set as follows:

Unit	Name of DIP switch	Mark	Setting before the Shipment	Function
Outdoor unit	Terminal resistance	DSW5		DSW5-1 is "ON" position before shipment. <ul style="list-style-type: none"> It is not necessary to set when H-LINK is connected with only one outdoor unit. When H-LINK is connected with more than one outdoor unit, set as follows: <ul style="list-style-type: none"> First outdoor unit: Keep DSW5-1 in "ON". Other outdoor units: Set DSW5-1 to "OFF".
	Refrigerant cycle	DSW4 RSW1		For setting the refrigerant cycle address of the outdoor unit. Set the DSW4 and RSW1 to overlap the setting of other outdoor units in the same H-LINK system.
Indoor unit	Refrigerant cycle	DSW5 RSW2		For setting the refrigerant cycle address of the indoor unit. Set the DSW5 and RSW2 corresponding to the address of outdoor unit in the same refrigerant cycle.
	Address of the indoor unit	DSW6 RSW1		Setting indoor unit address. Set the DSW6 and RSW1 not to overlap the setting of other indoor units in the same refrigerant cycle. (If no set, the automatic address function is performed.)

- Example of the setting of the DIP switches.

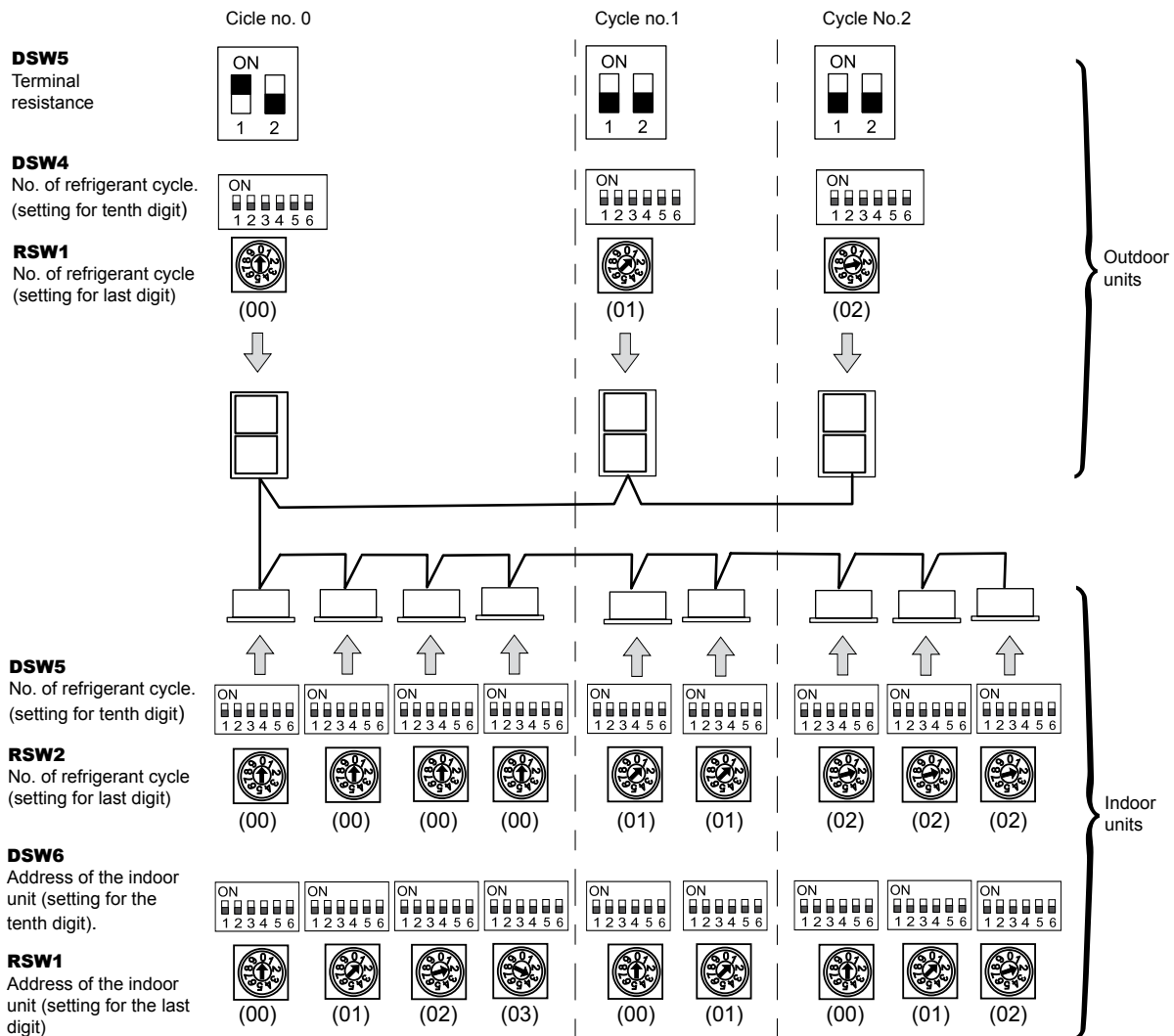

10.4.5 Examples of the system of connection between H-LINK and H-LINK II units

In the case of mixed systems with H-LINK and H-LINK II, set the H-LINK units in the first 16 position of the system, as in the following example where 42 systems are connected, 16 with indoor FSN1E units and 26 with indoor FSN2E units.

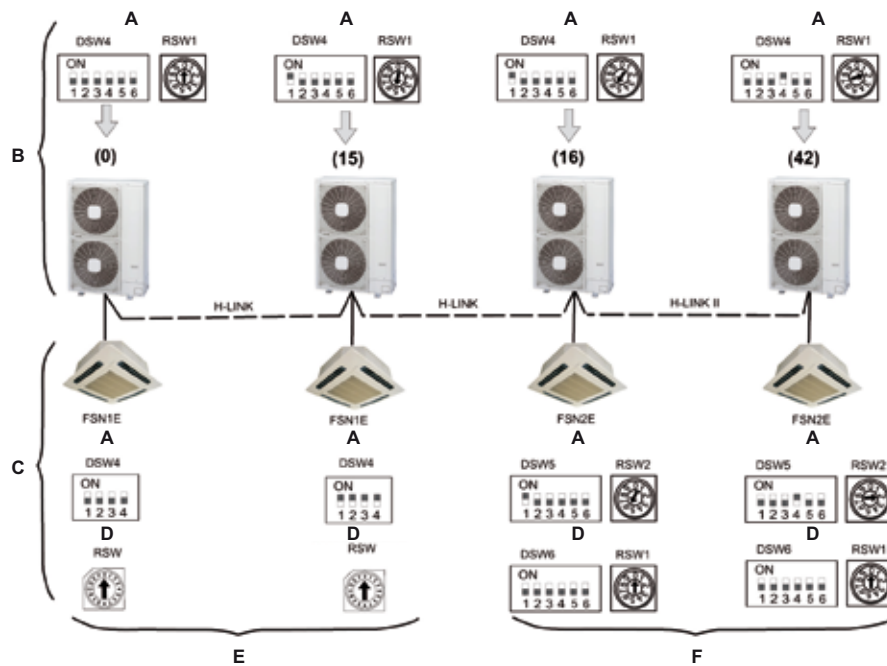

A: Refrigerant cycle.

B: Outdoor unit.

C: Indoor unit.

D: Indoor unit address.

E: Either the current remote control switch (H-LINK) or the new one (H-LINK II) can be used.

F: Only the new remote control switch (H-LINK II) can be used.



NOTE

- **The maximum number of indoor units than an H-LINK II can control is 160.**
- **If you use PSC-5S and the CSNET WEB 2.0 (systems only compatible with H-LINK) bear in mind that it will only recognize 16 indoor and 16 outdoor units.**

10.4.6 Examples of H-LINK II system

Two cases:

1. Using H-LINK II system for air conditioning systems without a central control device (CSNET WEB or PSC-A64S)

- Line connection with all units (including Utopia and/or Set Free, Mini Set Free and DC Inverter).

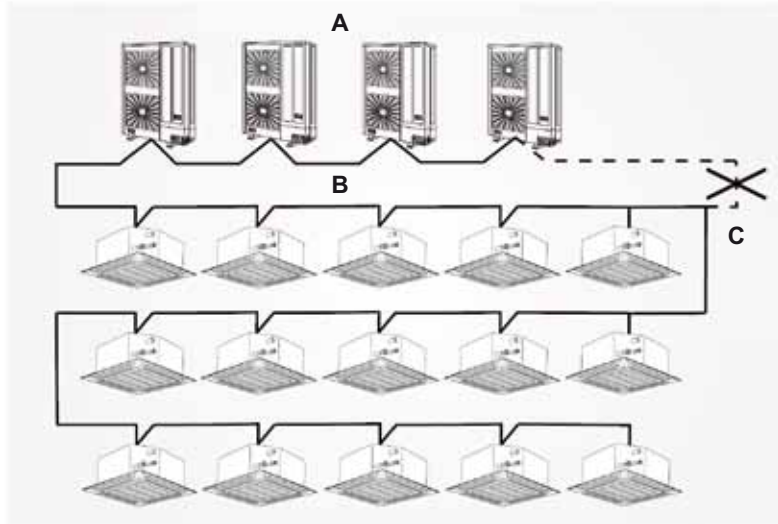

A: Outdoor units.

B: Indoor units.

C: Do not install wiring in a loop.

- Line connection for each floor.

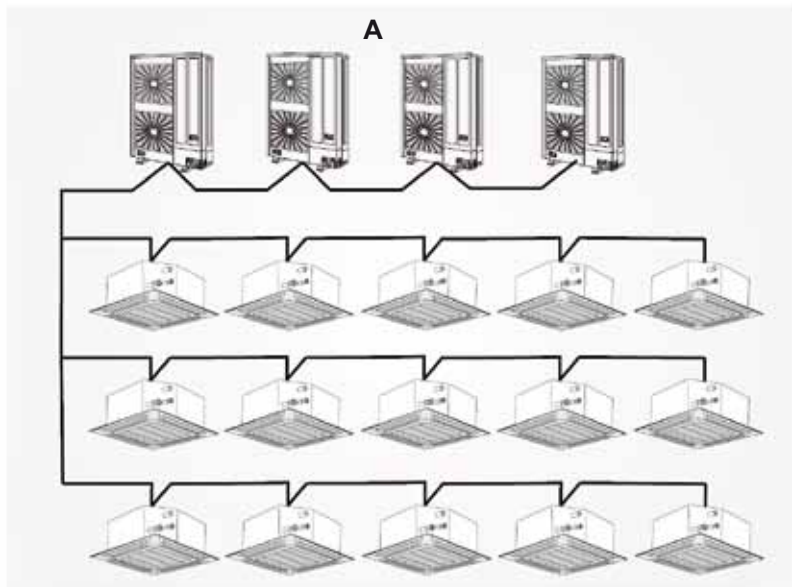

A: Outdoor units.

B: Indoor units.

- Connection with one main line and with the branch lines for the units.

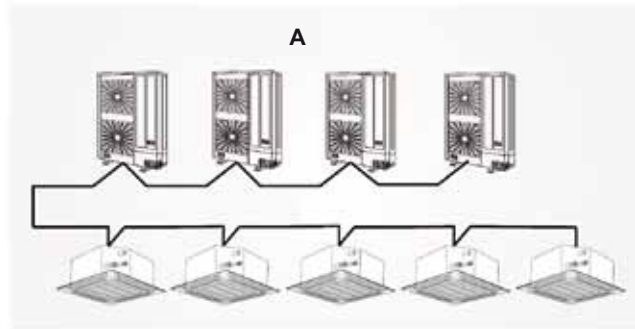

A: Outdoor units.

B: Indoor units.



CAUTION

- *The maximum number of units that can be connected is 64 outdoor units and 160 indoor units (including Utopia and/or Set Free, Mini Set-free).*
- *Do not install the wiring in a loop.*
- *If the H-LINK II system is not used when carrying out the electrical wiring as shown above, it must be used once the wiring of the instrument is completed. The DIP switches must therefore be set as specified in the DIP switches on the PCB.*

2. Using the H-LINK II system for air conditioning systems with a central control device (CSNET WEB or PSC-A64S)

- If the central control device is used when carrying out electrical wiring, the CS-NET WEB can be connected at any point of the H-LINK II wiring.

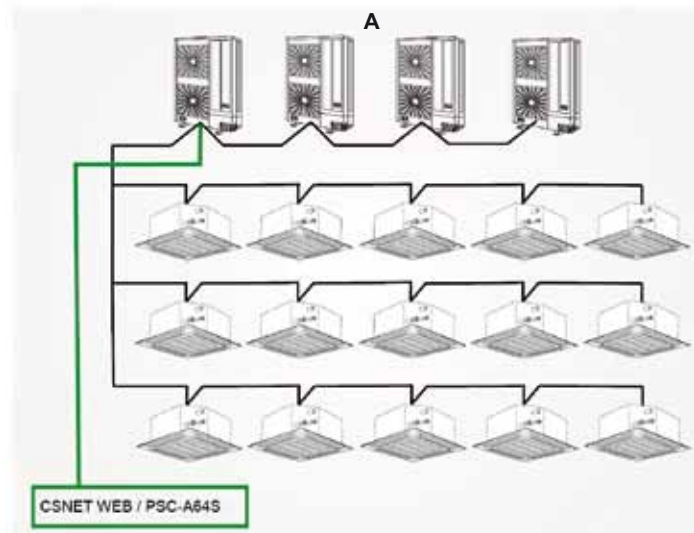

A: Outdoor units.

B: Indoor units.

- If the central control device is not used when electrical wiring is carried out, you must connect the H-LINK II wiring to all the systems. The easiest method is usually to connect the outdoor units.



NOTE

For CSNET WEB 2.0 the limitations are those corresponding to H-LINK.

11. Optional functions

Index

11.1. RAS-(4-6)FS(V)N(Y)2E	130
11.2. For operation with CS-NET WEB	131

11.1 RAS-(4-6)FS(V)N(Y)2E

Optional function	Explanation
Setting for the energy saving request function.	This function regulates the outdoor unit consumption to 50%, 75% or 100%. If the required power is above the set value, the capacity of the indoor unit will be reduced proportionally to the power consumption of the outdoor unit. It can even come to a thermostatic stop if necessary. This function can be configured using an external or internal signal, depending on the needs of the installation. Configuration by external signal is very useful for setting up groups of outdoor units. The internal signal is useful for setting up a single outdoor unit.
Saving Energy Operation	If this function is activated the compressor is stopped when less than 35 Hz are requested from the indoor unit and the indoor units are on thermo OFF.
Low speed defrost adjustment.	When this function is activated the indoor fan speed at defrost mode changes to slow instead of stopping the fan.
Low noise setting	This function decreases the sound levels of the outdoor units by reducing the maximum working frequency of the compressor (Cooling/Heating).
Night mode (low noise) operation	This function reduces the sound level of the outdoor units by decreasing the maximum working frequency of the compressor and the fan airflow according to the outside temperature (only for cooling mode).
Change of defrost operation conditions	This function changes the defrosting operation conditions. It is particularly useful for cold areas.
Protection against cold air discharge (1)	When the air discharge temperature of the indoor unit is less than or equal to 10 °C in cooling mode, the fans stop and the frequency of the outdoor unit is reduced, thereby preventing any discomfort to the occupants of the room.
Protection against cold air discharge (2)	When the discharge temperature of the air in the indoor unit is less than or equal to 10 °C in cooling mode, the compressor stops and alarm no. (d1-07) appears.
Wave function setting	This function controls the outdoor unit consumption in the following way: It allows a consumption of 100% for 20 minutes. The following 10 minutes it goes down to 50/75% and the alternates between 100% and 90/70%.
Piping for the R407C / R22	If you use conventional R407C or R22 piping instead of the R410A, the piping pressure will increase. This function is activated in order to avoid this pressure increase.
Alternation of the defrost mode activation	This function is useful in an installation consisting of various outdoor units placed in the same H-LINK. The defrost mode is activated alternately in each outdoor unit.
Setting the cooling mode	This function sets the cooling mode: the indoor unit will only start when the system is on COOL or DRY.
Individual operation	This function changes the individual operation of each indoor unit to multiple operation.

11.2 For operation with CS-NET WEB

Optional function	Explanation
Historical data	CS-NET WEB generates a file with this information so the data can be consulted.
Power consumption	
Automatic COOL/HEAT operation	This function changes automatically from Cool to Heat operation.
Setting the operation mode	This function eliminates the possibility of changing the operation mode from the remote controller.
Setting set temperature	This function eliminates the possibility of changing the set temperature from the remote controller.
Setting air volume	This function eliminates the possibility of changing the fan speed from the remote controller.

12. Troubleshooting

Index

12.1. On-screen displays during abnormal operation	134
12.2. Alarm codes	135

12.1 On-screen displays during abnormal operation

Abnormal operation can be produced due to the following reasons:

- Malfunction

The RUN (red) indicator flashes.

The ALARM indicator appears on the liquid crystal display.

The screen also displays the following items:

- A: indoor unit address.
- B: Refrigerant cycle number.
- C: Alarm code.
- D: Model code.
- E: If there are various indoor units connected, the above mentioned information is shown for each one of them.

Write down the indications and contact your HITACHI service supplier.

- Power supply failure.

All displays disappear.

If the unit stops due to a power shortage, it will not start again, even though the power comes back on. Carry out the start-up operations again.

If the power failure lasts less than 2 seconds, the unit will start again automatically.

- Electrical noise

The displays can disappear from the screen and the unit can stop. This is because the microcomputer has been activated to protect the unit from electrical noise.

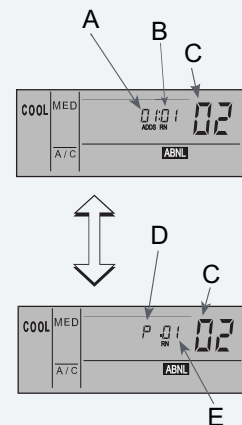

NOTE

If the wireless remote control is used for the wall-type indoor unit, remove the connectors (CN25) that are connected to the indoor PCB. Otherwise the unit will not work. The stored data cannot be erased unless the remote control is initialised.

Model code	
Indication	Model
H	Heat pump
P	Inverter
F	Multi (SET-FREE)
L	Cooling only
E	Other
b	IVX, individual operation
L	KPI

12.2 Alarm codes

Code No.	Category	Abnormality	Cause
01	Indoor Unit	Tripping of Protection Device	Failure of Fan Motor, Drain Discharge, PCB, Relay, Float Switch Activated
02	Outdoor Unit	Tripping of Protection Device	Activation of PSH, Locked Motor, abnormal operation in the Power Supply phase.
03	Transmission	Abnormality between Indoor (or Outdoor) and Outdoor (or Indoor)	Incorrect Wiring, Failure of PCB, Tripping of Fuse, Power Supply OFF
04		Abnormality between Inverter and Control PCB	Failure in Transmission between PCBs for Inverter
05	Power Supply	Abnormality power supply	Abnormal wave form of power supply.
06	Voltage Drop	Voltage Drop by Excessively Low or High Voltage to Outdoor Unit	Voltage Drop of Power Supply. Incorrect Wiring or insufficient Capacity of Power Supply Wiring
07	Cycle	Decrease in Discharge Gas Superheat	Discharge Gas SUPERHEAT less than 10 deg. is maintained for 30 minutes.
08		Increase in Discharge Gas Temperature	Temperature of top Compressor: Td Td \geq 132°C over 10 minutes, or Td \geq 140°C over 5 minutes
11	Sensor on Indoor Unit	Inlet Air Thermistor	Failure of Thermistor, Sensor, Connection.
12		Outlet Air Thermistor	
13		Freeze Protection Thermistor	
14		Gas Piping Thermistor	
16		Remote thermistor	Failure of thermistor
17		Thermistor of RCS	Failure of thermistor
19		Tripping of Protection Device for Fan Motor	Failure of Fan Motor
21	Sensor on Outdoor Unit	High Pressure Sensor	Incorrect wiring, disconnected wiring, broken cable, short circuit.
22		Outdoor Air Thermistor	Failure of Thermistor, Sensor, Connection
23		Discharge gas thermistor at top of Compressor	Incorrect wiring, disconnected wiring, broken cable, short circuit.
24		Evaporating Thermistor	Failure of Thermistor, Sensor, Connection
29		Low Pressure Sensor	Incorrect wiring, disconnected wiring, broken cable, short circuit.
31	System	Incorrect Setting of Outdoor and Indoor Unit	Incorrect Setting of Capacity Code.
35		Incorrect Setting in Indoor Unit No.	Duplication of Indoor Unit number, N° of Indoor unit over specifications.
36		Incorrect combination of Indoor Unit	R22 Indoor Unit
38		Abnormality of Protective Circuit in Outdoor Unit	Failure of Indoor Unit PCB. Incorrect wiring. Connection to PCB in Indoor Unit.
43	Pressure	Pressure ratio decrease	Abnormal compress (Compressor, Inverter damage)
44		Low pressure increase protection device activation	Overload during cooling, High temperature with heating, Locked expansion valve
45		High pressure increase protection device activation	Overload (obstruction of HEX, short circuit) mixture of inert gas
47		Activation of Low Pressure Decrease Protection Device	Stoppage by Excessively Decrease of evaporating Temperature (Te < -35°C) is activated 3 times in one hour, Locked Motor in Heating Operation.

Code No.	Category	Abnormality	Cause
48	Inverter	Activation of overload protection	Failure of IPM or PCB2, heat exchanger clogged, locked compressor, EVI/EVO failure or overcharge.
51		Abnormality of Current Sensor for Inverter	Failure of Control PCB, Inverter Module.
53		Protection Activation of Transistor Module	Transistor Module Abnormality. Failure of Compressor, clogging of Heat Exchanger.
54		Inverter Fin Temperature Increase	Abnormal Inverter Fin Thermistor. Clogging of Heat Exchanger Abnormal Outdoor Fan
55		Inverter Module Abnormality	Failure of Inverter Module.
57	Outdoor Fan	Fan Motor Abnormality	Disconnected wire of Incorrect wiring between Control PCB and Inverter PCB. Incorrect Wiring or Fan Motor Abnormality
96	Sensor of KPI Unit	Room temperature thermistor	Failure of thermistor, sensor, connection.
97		Outdoor temperature thermistor	
b1	Indoor unit No. setting	Incorrect address No. Setting or refrigerant cycle	Over 64 indoor units setting by No. or indoor unit address.
b5		Connection number of the indoor unit incorrectly set	There are more than 17 units not corresponding to H-Link II connected to one system
EE	Compressor	Compressor protection alarm	Failure of compressor.

Hitachi Air Conditioning Products Europe, S.A.
Ronda Shimizu, 1 - Políg. Ind. Can Torrella
08233 Vacarisses (Barcelona) España



Hitachi certifies that our products have met EU consumer safety, health and environmental requirements.



Hitachi Air Conditioning Products Europe, S.A. is certified with:
ISO 9001 of AENOR, Spain for its Quality Management accordance with the standard
ISO 14001 of AENOR Spain for its Environmental Management systems accordance with the standard.



Hitachi air conditioning products are manufactured according to:
ISO 9001 of JQA, Japan for its Quality Management accordance with the standard
ISO 14001 of JACO, Japan for its Environmental Management accordance with the standard.