

NEW AQUAREA AIR

Panasonic

32%
MORE EFFICIENT
THAN STANDARD
RADIATORS

New line up of super low temperature radiators for Heat Pump application

- Only 1 water temperature on the water circuit (35°C)
- COP with water at 35°C is 32% higher than efficiency with water at 45°C
- Extremely compact

AQUAREA
AIR

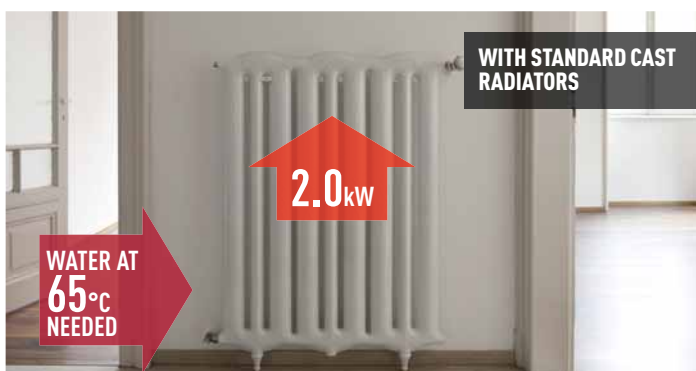
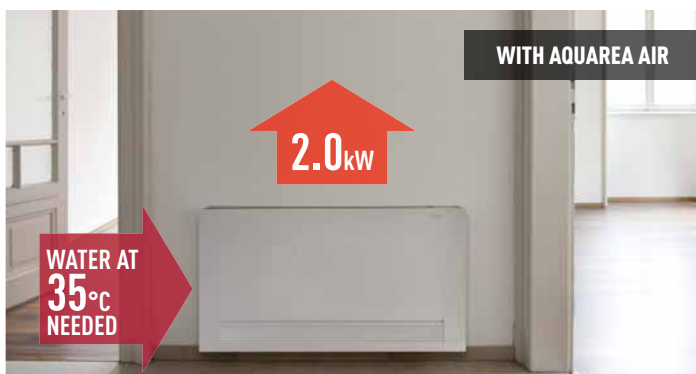

Panasonic Aquarea Air Radiators

The slimline Panasonic Aquarea Air radiators deliver high efficiency climate control. With a depth of just under 13 cm they are at the cutting edge of the market. Blending easily into the home, Aquarea Air's elegant design and product refinements are clear to see in every detail.

The Aquarea Air's slimline profile has been achieved thanks to the innovative layout of the ventilation unit and the heat exchanger. The fan is tangential with asymmetric blades and the large surface heat exchanger enables high airflows to be achieved with low pressure loss and low noise levels. Exceptional ventilation efficiency means the motor uses considerably less energy (low wattage). The fan speed is continuously modulated by the temperature controller with proportional integral logic, with undoubted advantages for regulating the temperature and humidity in summer mode.

All temperature curves and capacity are available on www.panasonicproclub.com

During winter, the operating principle is based on micro fans of very low power consumption and minimum noise that send hot air, coming from the heat exchanger, to the inside of the front panel of the device and therefore heat it effectively. With this principle, the terminal also provides significant power while heating, without running the main fan. Comfort temperatures are therefore maintained, without air movements and in silence. In summer mode, the airflow generated by the micro fans is stopped to avoid any dew formation on the terminal's front surface.

Radiant effect for better comfort

Very silent and efficient DC fan motor

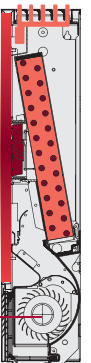

RADIATORS FOR HEAT PUMP APPLICATION

AQUAREA AIR 200/700/900 WITH RADIATING EFFECT



PAW-AAIR-900



PAW-AAIR-700 PAW-AAIR-200

Major Benefit

- On the water installation
 - Only 1 water temperature on the water circuit (35°C)
 - No expansive 2 zone kits
 - No overflow valve (as Aquarea Air has a 3-way valve)
 - Very easy to install
- On the efficiency
 - COP with water at 35°C is 32% higher than efficiency with water at 45°C! (case MDF06, at +7°C)

Main features

- Front panel heating with radiant effect
- High heating capacity (without main fan running)
- 4 fan speeds and capacities
- Exclusive design
- Extremely compact (only 12.9 cm deep)
- Cooling and dehumidification functions possible (drain is needed)
- 3-way valve included (no overflow valve needed on the installation if more than 3 radiators installed)
- Touch screen thermostat - Automatic vertical airflow control

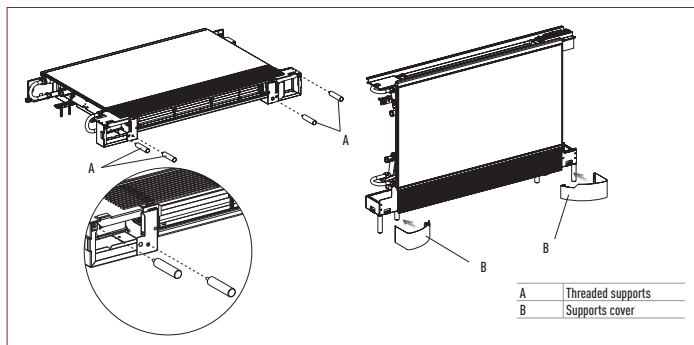
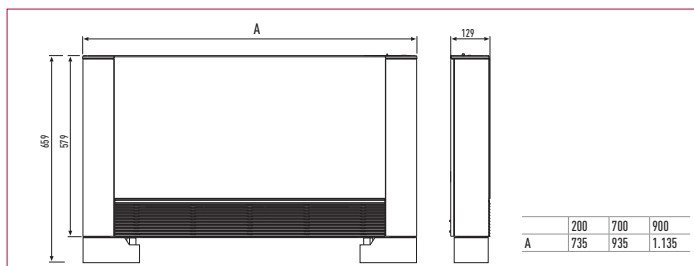

Accessories for Aquarea Air

PAW-AAIR-LEGS-1* Kits of 2 legs to support the Aquarea Air on the floor and to protect the water pipings

* Available from March 2014

Operating on heating mode with radiator using only radiant effect

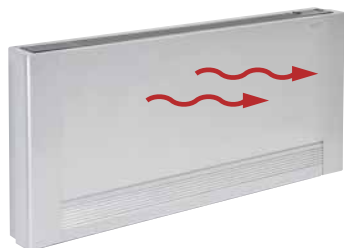

Operating on heating mode with radiant effect and fan mode

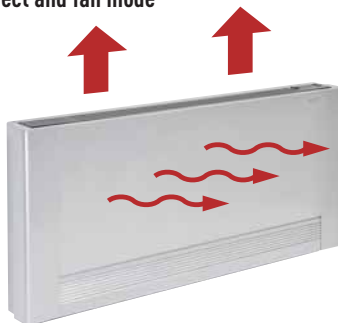

Operating on cooling mode with fan



Fan Coils for Heat Pump application	PAW-AAIR-200						PAW-AAIR-700					PAW-AAIR-900									
	PAW-AAIR-200L						PAW-AAIR-700L					PAW-AAIR-900L									
Total heating capacity	W	138	160	217	470	570	223	360	708	1.032	1.188	273	475	886	1.420	1.703					
Water flow	kg/h	23,7	27,5	37,3	80,8	98,0	38,4	61,9	121,8	177,5	204,3	47,0	81,7	152,4	244,2	292,9					
Water pressure drop	kPa	0,1	0,2	0,4	2,0	2,9	0,1	0,1	0,3	0,8	1,0	0,1	0,2	0,5	1,6	2,2					
Air flow	m ³ /h	28	37	55	113	162	44	84	155	252	320	54	110	248	367	461					
	Speed	Main	Fan	Off	Super	Min	Med	Max	Main	Fan	Off	Super	Min	Med	Max	Main	Fan	Off	Super	Min	Med
Maximum input power	W	2	5	7	9	13	3	9	14	18	22	3	11	16	20	24					
Sound pressure level	dB(A)	17,6	18,8	24,7	33,2	39,4	18,4	19,6	25,8	34,1	40,2	18,4	22,3	26,2	34,4	42,2					
Inlet water temperature	°C	35	35	35	35	35	35	35	35	35	35	35	35	35	35	35					
Outlet water temperature	°C	30	30	30	30	30	30	30	30	30	30	30	30	30	30	30					
Inlet air temperature	°C	19	19	19	19	19	19	19	19	19	19	19	19	19	19	19					
Outlet air temperature	°C	34,5	32,6	38,9	32,0	30,0	34,9	32,4	33,3	31,8	30,6	34,8	32,5	30,2	31,1	30,6					
Dimensions (W x H x D)	mm	735 x 576 x 129						935 x 579 x 129					1.135 x 579 x 129								
Weight	kg	17						20					23								
3 ways valve included		Yes						Yes					Yes								
Touch screen thermostat		Yes						Yes					Yes								

Panasonic®

To find out how Panasonic cares for you, log on to: www.aircon.panasonic.eu

Panasonic Marketing Europe GmbH
Panasonic Air Conditioning: Hagenauer Strasse 43, 65203 Wiesbaden, Germany

heatingandcoolingsystems



Logicool Air Conditioning & Heat Pumps Ltd
The Machine House, Newfields
DE12 6EG Leicestershire
01283 218277
www.logicool-ac.com
sales@logicool-ac.com