

PLA-ZRP35BA.UK  
PLA-ZRP71BA.UK

PLA-ZRP50BA.UK  
PLA-ZRP125BA.UK

PLA-ZRP60BA.UK  
PLA-ZRP140BA.UK

Unit: mm

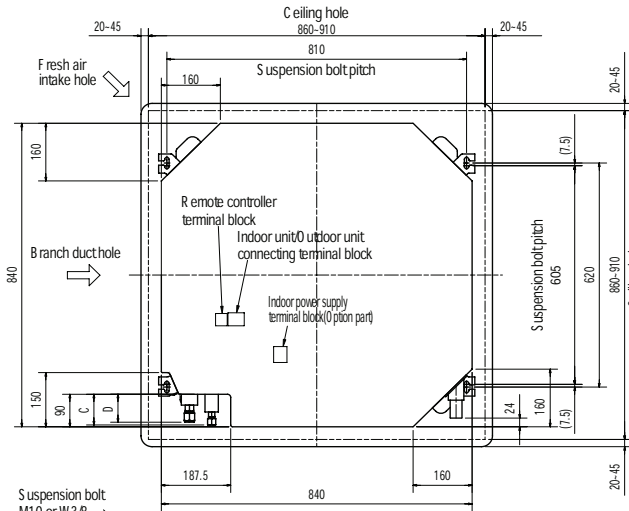

D detail connecting of branch duct (Both aspects)

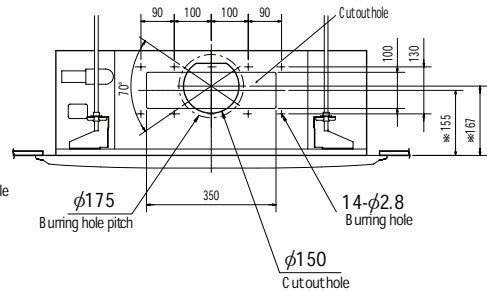

D detail drawing of fresh air intake hole

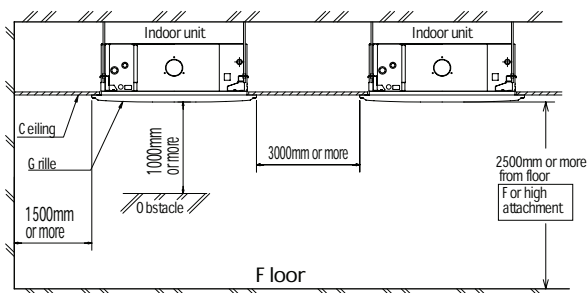
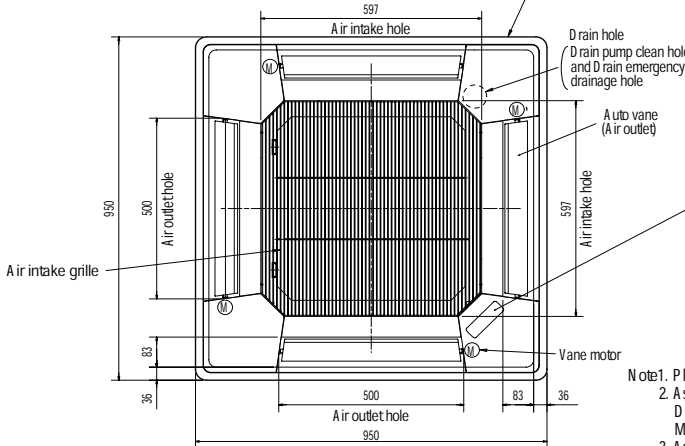
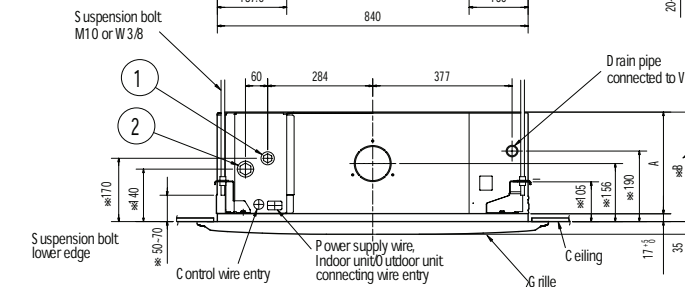
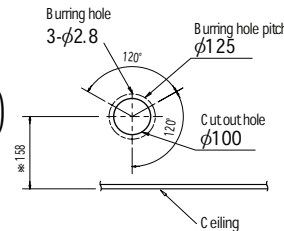

(Connected the attached flexible pipe or socket)  
Keep approximately 10 to 15mm space between unit ceiling and ceiling slab.

In case of standard grille: PLP-6BA / PLP-6BAM D



In case of auto-grille: PLP-6BA J

In case of wireless remote controller: PLP-6BAL M

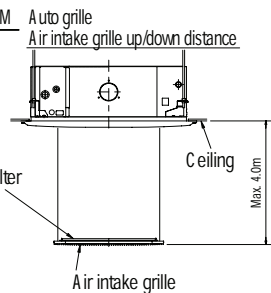
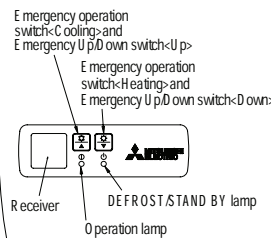

- Note1. Please choose the grille from a standard grille, auto-grille.  
 2. As for drain pipe, please use VP-25 (O.D. φ32 PVC TUBE). Drain pump is included. Max. lifting height is 850mm from the ceiling.  
 3. As for suspension bolt please use M10 or W3/8. (Procured at local site)  
 4. Electrical box may be removed for the service purpose. Make sure to slack the electrical wire little bit for control/power wires connection.  
 5. The height of the indoor unit is able to be adjusted with the grille attached.  
 6. For the installation of the optional high efficiency filter or optional multi-functional casement:  
 1) Requires 100mm or more space between transom and ceiling for the installation.  
 2) Add 135mm to the dimensions \* marked on the figure.  
 3) The optional high efficiency filter must be used jointly with the optional multi-functional casement.  
 7. When installing the branch ducts, be sure to insulate adequately. Otherwise condensation and dripping may occur. (It becomes the cause of dew drops/Water dew)  
 8. As for necessary installation/service space, please refer to the left figure.

Models	①	②	A	B	C	D	E
PLA-ZRP 35/50BA	Refrigerant pipe ...φ6.35 Flared connection ...1/4 inch	Refrigerant pipe ...φ12.7 Flared connection ...1/2 inch	241	258	80	74	400
PLA-ZRP 60BA	Refrigerant pipe φ6.35 / φ9.52 Flared connection 1/4 inch / 3/8 inch (compatible)	Refrigerant pipe ...φ15.88 Flared connection ...5/8 inch					
PLA-ZRP 71/125/140BA	Refrigerant pipe ...φ9.52 Flared connection ...3/8 inch		281	298	85	77	440